

KATALOG I PORADNIK TECHNICZNY 2023.1



OBRÓBKA I WYKONYWANIE OTWORÓW

SECO

>30 000

STANDARDOWYCH
PRODUKTÓW



>75

KRAJÓW



>4100

PRACOWNIKÓW



Firma Seco Tools posiada centralę w miejscowości Fagersta w Szwecji i jest obecna w ponad 75 krajach, to globalny dostawca rozwiązań do obróbki metalu obejmujących frezowanie, toczenie, obróbkę otworów oraz systemy narzędziowe.

Przez ponad 80 lat firma dostarcza technologię, procesy oraz wsparcie przyczyniające się do poprawy produktywności oraz dochodowości naszych partnerów.

Więcej informacji na temat innowacyjnych produktów oraz usług Seco Tools oferowanych wszystkim sektorom przemysłu, można znaleźć na stronie www.secotools.com.

Wstęp

Indeks alfanumeryczny, narzędzia	4-5
Indeks alfanumeryczny, płytki	6
Wytyczne i przegląd	7-14

Wiercenie

Universal & Feedmax™

Przegląd asortymentu i informacje techniczne	15-24
Wiertła Universal	25-54
Wiertła Feedmax	55-127
Wytyczne i parametry skrawania	128-168

Crownloc®

Przegląd asortymentu i informacje techniczne	169-172
Korpusy i końcówki Crownloc	173-188
Wytyczne i parametry skrawania	189-196

Crownloc® Plus

Przegląd asortymentu i informacje techniczne	197-200
Korpusy i końcówki Crownloc Plus	201-216
Wytyczne i dane skrawania	217-222

Perfomax®

Przegląd asortymentu i informacje techniczne	223-229
Korpusy i płytki Perfomax	230-286
Wytyczne i dane skrawania	287-318

Oprawki do wiertel

Przegląd	319
Oprawki	320

Rozwiercanie

Precimaster™ Plus

Przegląd asortymentu i informacje techniczne	321-337
Końcówki Precimaster Plus i oprawki	338-352
Wytyczne i dane skrawania.....	353-362

NANOFIX™

Przegląd asortymentu i informacje techniczne	363-372
Rozwiertaki Nanofix i oprawki	373-388
Wytyczne i parametry skrawania	389-397

BIFIX®

Przegląd asortymentu i informacje techniczne	398-403
Oprawki Bifix, adaptory i płytki.....	404-412
Wytyczne i dane skrawania.....	413-424

Xfix™

Przegląd asortymentu i informacje techniczne	425-431
Głowice Xfix, adaptory i płytki.....	432-455
Wytyczne i dane skrawania.....	456-466

Uchwyty do rozwiertaków

Ogólny opis	467-469
-------------------	---------

Oprawki nastawne

Oprawki	470-479
---------------	---------

Oprawki wahliwe

Oprawki	480-485
---------------	---------

Przyrząd do ustawiania

Oprawki	486-491
---------------	---------

Wytaczanie

Wytaczanie zgrubne

Przegląd asortymentu i informacje techniczne	492-493
Graflex®	494-523
Seco-Capto™	524-560
Wytaczanie zgrubne.....	561-565
Głowice i oprawki wytaczające RB750	566-575
Głowice i uchwyty wytaczające RB610	579-583

Wytaczanie wykańczające

Przegląd asortymentu i informacje techniczne	584-589
Głowice wytaczające i uchwyty FB760, FB780, FB790, FB620	590-615
Głowice promieniowe	616-630

Belki

Przegląd asortymentu i informacje techniczne	631-642
Uchwyty i adaptory, wytaczaki, bloki, kasety	643-648

Narzędzia do wytaczania wykonywane na zamówienie	649
--	-----

Płytki do wytaczania	650-657
----------------------------	---------

Parametry skrawania.....	658-661
--------------------------	---------

Klucze do płytek i śruby	662
--------------------------------	-----

Głowice wytaczające, złącza Graflex® lub Seco-Capto™	663-665
--	---------

Załącznik

Tolerancja wg normy ISO dla otworów i wałków	666-668
Tolerancja geometryczna	669
Obrabiane materiały – SMG.....	670-681
Deklaracja zgodności	682-684

Wstęp

Wiercenie

Rozwiercanie

Wyłaczanie

Załącznik

0
 02E93 523
 03E93 523

2
 20E93 523

A
 A610 579, 582
 A724 626-627
 A725 626-627
 A726 626-627
 A729 628
 A731 643-646
 A750 566-567, 569-573
 A760 590-591, 595
 A761 593
 A762 594
 A763 594
 A765 594, 596
 A780 620-621
 A782 626-627
 A789 629
 A790 623
 AFG0629 601

B
 BA...-FB 625
 BA...-RB 581
 BAS25 599-600
 BDA16 598
 BM*6100 320
 BM*6101 320

C
 C.-390.00 526-527
 C.-390.411 532
 C.-390.55 538-539
 C.-390.605 540
 C.-390B.140 436, 442, 448, 454, 534-535
 C.-390B.55 436, 442, 448, 538-539
 C.-390B.58 436, 442, 448, 454, 538-539
 C.-391.01 436, 442, 448, 454, 547-548, 551
 C.-391.02 436, 442, 549-550, 553-554
 C.-391.0401 510-511
 C.-391.0750 568
 C.-391.0760 592
 C.-391.0780 622
 C.-A390B.45 528-529
 C.-D...-BA 560
 C.-D...-GL 558-559

E
 E2342*5191 544
 E2344*5191 544
 E3114*5191 542-543
 E3116*5191 542-543
 E3169*5191 536
 E3171*5191 536
 E3416731200 643
 E3471731200 643
 E4002*5191 542-543
 E9306731200 643
 E9374-D...-GL 555-556
 E9376-D...-BA 557
 E9376-D...-GL 555
 E9474*5191 546
 EM*0040 500
 EM*0050 500
 EM*2502 506-507

EM*2504 506-507
 EM*2642 508-509
 EM*2644 508-509
 EM*3214 504-505
 EM*3216 504-505
 EM*3414 437, 443, 449, 502-503
 EM*3416 437, 443, 449, 455, 502-503
 EM*3469 437, 443, 449, 498-499
 EM*3471 437, 443, 449, 455, 498-499
 EM*4002 504-505
 EM*4040 501
 EM*9303 496-497
 EM*9304 437, 443, 449, 496-497
 EM*9306 437, 443, 449, 455, 496-497

G
 GL25 580, 624
 GL32 580, 624
 GL40 580, 624
 GL50 580, 624

H
 HA...-C 436, 442, 448, 454, 530-531
 HF100 454-455
 HF32 436-437
 HF55 442-443
 HF80 448-449
 HF85 432, 438, 444, 450
 HF85B 433, 439, 445, 451
 HF86 434, 440, 446, 452
 HF86B 435, 441, 447, 453
 HSKA*C 530-531
 HSKA*G 496
 HSKTA...-GL 555-556

M
 M401 519-521
 M402 437, 443, 449, 455, 512-513
 M403 514-518, 522

N
 NF06 373-374, 377
 NF10 374-377
 NF4 379
 NF6 378
 NFQF 388
 NS06 380-381, 385
 NS10 381-385
 NS4 387
 NS6 386

P
 PCGNR/L16CA 647
 PMX05 341
 PMX06 341, 345-348
 PMX06B-16B 343
 PMX08 341, 346-348
 PMX12 341, 345-348
 PMX16 341, 345-348
 PMX4 351
 PMX5 338-339, 349
 PMX6 338, 340, 350
 PMX8 352
 PMX-AD 345-346
 PMXB-FL 348
 PMX-FL 347

S	
SAH	471-477
SCGL	647
SD100	188
SD101	173-174
SD103	175-176
SD105	177-178
SD107	179-180
SD1103	26-31
SD1103A	32-37
SD1105A	38-45
SD1108A	46-50
SD1112A	51-54
SD200	85-86
SD203	112
SD203A	83-84
SD203A-M	97-99
SD203A-MS	88-92
SD203A-N	105-106
SD203A-P	56-61
SD203A-T	103
SD205A	100-102, 110-111
SD205A-MS	93-96
SD205A-P	62-69
SD205A-T	104
SD206	70
SD206A	71
SD207A-P	72-74
SD216A	75
SD22	114-120
SD230A	76
SD245A	78-79
SD26	121-127
SD265A	81
SD400	213
SD403	201-204
SD405	205-208
SD408	209-212
SD522	230-232, 234, 236-238
SD523	240-249, 251-254, 256-257
SD524	259-260, 262-267, 269-272
SD525	273-275
SD542	276-277
SD572	278, 280-281
SD602	285
SF	466, 486-488
SFH	481-485
SR80	406
SR81	409
SR82	410
SSRCL	647
STGCR/L.CA	647
STRCR/L.CA	647
STSCR/L.CA	647
STTCR/L.CA	647

Wstęp

C
 CCGT 654, 656-657
 CCGW 656-657
 CCMT 654, 656-657
 CCMW 656-657
 CNMG 655
 CPGT 654

L
 LNEG 429

R
 RNAX 429

S
 SCGX 291-293
 SCMT 654
 SD100 181
 SD100-K 181-187
 SD100-M 181-187
 SD100-P 181-187
 SD400-M 214-216
 SD400-P 214-216
 SPGX 291, 295

T
 TCGT 654, 656-657
 TCGW 656-657
 TCMT 654, 656-657
 TCMW 656-657

W
 WBGT 656-657
 WBGW 656-657
 WCMX 297-298

Wiercenie

Rozwiercanie

Wytaczanie

Załącznik

Przezwyciężaj wszelkie wyzwania związane z obróbką otworów







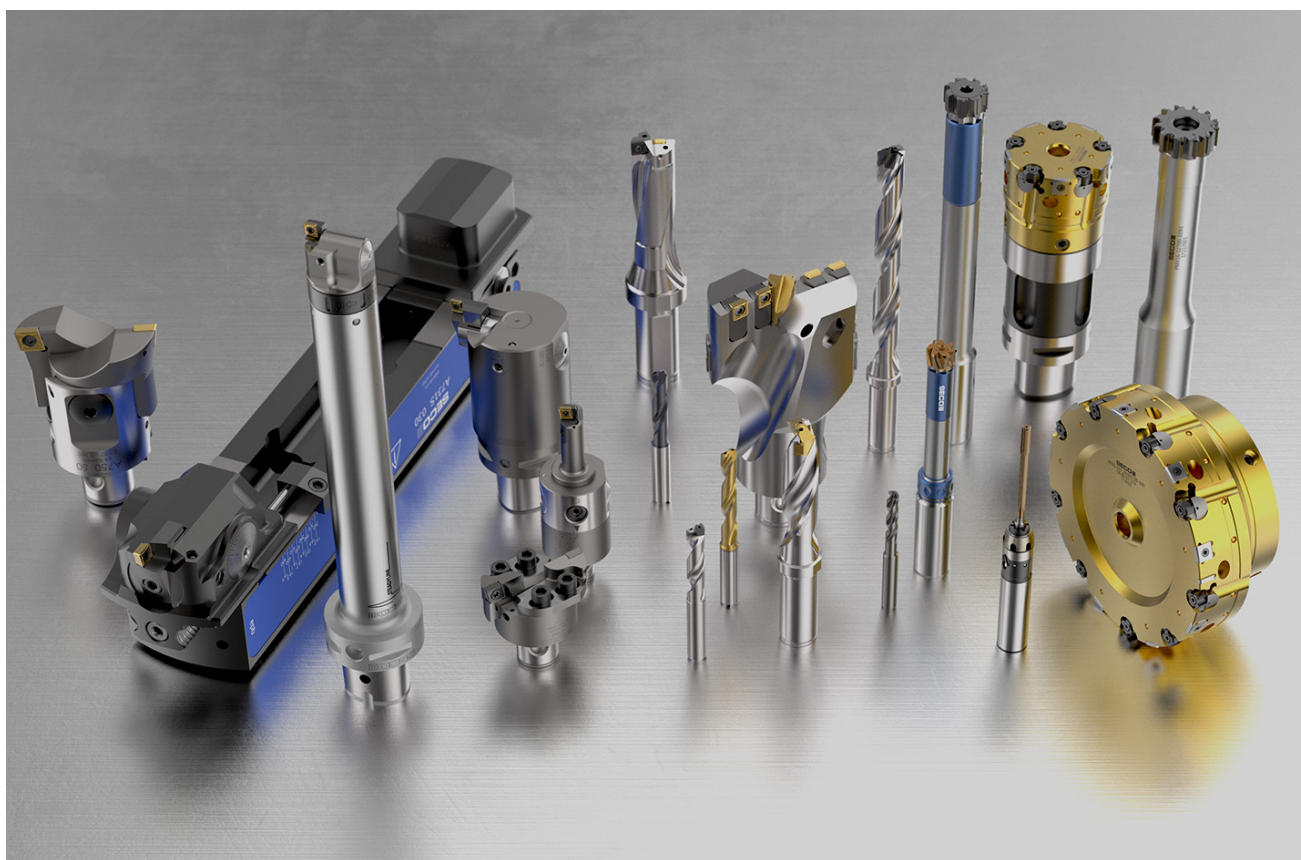







Obróbka otworów może oznaczać różnicę między zyskiem i złomowaniem części, a sukces wymaga najwyższej jakości narzędzi, które zapewniają najwyższy poziom poprawy wydajności i możliwości redukcji kosztów. Aby osiągnąć ten poziom sukcesu, producenci potrzebują partnera, który pomoże im sprawdzić procesy i przetestować nowe rozwiązania. Partnera, który może sprostać wszystkim wyjątkowym wyzwaniom dzięki rozbudowanej gamie narzędzi do wiercenia, rozwiercania, wytaczania i gwintowania.

Seco Tools jest dostawcą rozwiązań z zakresu obróbki otworów z jednego źródła. Dzięki wieloletniemu doświadczeniu w opracowywaniu rozwiązań do obróbki otworów dla wymagających zastosowań mamy specjalistyczną wiedzę w zakresie badań i rozwoju oraz skrawania metali, aby pomóc producentom w osiągnięciu w pełni optymalnego procesu.

Jesteśmy zaangażowani w wydajność obróbki otworów u naszych klientów. Oznacza to, że można zakupić narzędzia, uzyskać pomoc techniczną, skonsultować się z ekspertami i opracować rozwiązania z jednym dostawcą i z dostępem do najbardziej wszechstronnej w branży gamy wiertel skrawających i pełnych, rozwiertaków, gwintowników i głowic do wytaczania.



Jakie są Twoje oczekiwania odnośnie wykonywania otworów?

	Wiercenie			Rozwiercanie				Wytaczanie			Wyk. gwintu		
	Seco Universal Seco Feedmax™	Crownloc® Crownloc® Plus	Perfomax®	Precimaster™ Plus	Nanofix™	Bifix®	Xfix™	Wytaczanie zgrubne	Wytaczanie wykańczające	Threadmaster™	Gwintowniki Threadmaster™	Frezowanie gwintów 396.18/19/20	
Str.	25-168	169-222	223-318	323-362	363-397	398-424	425-466	561-583	584-630	Patrz Katalog Gwintowanie			
													
IT	7-9	9-10	12	6-8	6-8	6-7	6-7	9-10	5-6	-	-	-	
	0,02 mm (0.0008")	0,05 mm (0.002")	-	Podąża za wstępnym otworem	Podąża za wstępnym otworem	Podąża za wstępnym otworem	Podąża za wstępnym otworem	0,005 mm (0.0002")	0,005 mm (0.0002")	-	Podąża za wstępnym otworem	Podąża za wstępnym otworem	
	0,02 mm (0.0008")	0,05 mm (0.002")	-	0,007 mm (0.0003")	0,007 mm (0.0003")	0,005 mm (0.0002")	0,005 mm (0.0002")	0,02 mm (0.0008")	0,01 mm (0.0004")	-	-	-	
	1,0 μm (39 μin)	1,6 μm (63 μin)	2,0 μm (79 μin)	0,6 μm (24 μin)	0,6 μm (24 μin)	0,25 μm (10 μin)	0,8 μm (31 μin)	1,0 μm (39 μin)	0,6 μm (24 μin)	-	-	-	
TCTR	-	-	-	-	-	-	-	-	-	-	6H 6HX 6G 2B Normal	5HX 2BX Normal-X 6HX 6GX	
Profil gwintu	-	-	-	-	-	-	-	-	-	M MF UNC UNF NPT NPTF BSP	M MF UNC UNF G NPT NPTF	M MF UNC UNF G	

**Dokładność pozycjonowania**

Wiertła Seco Feedmax, głowice zgrubne A750 oraz cały pozostały asortyment głowic do wytaczania na gotowo, są narzędziami które oferują najlepszą dokładność pozycjonowania.

**Geometria otworu**

Wszystkie wiertła, głowice wytaczarskie i rozwiertaki Seco, zapewniają doskonałą geometrię otworu, kołowość, prostoliniowość i jakość. Głowice wytaczarskie Seco zawsze gwarantują najlepszy rezultat.

**Chropowatość powierzchni**

W celu uzyskania małej chropowatości powierzchni, jako pierwszy wybór należy stosować rozwiertaki Bifix, razem z głowicami do wytaczania na gotowo.

TCTR

= Klasa tolerancji gwintu

IT

= Tolerancja otworu

Wymiary ISO

Wymiary ISO	Opis
ADJLN	Minimalny zakres regulacji
ADJLX	Maksymalny zakres regulacji
ADJRG	Zakres regulacji
AN	Główny kąt przyłożenia
APMX	Maksymalna głębokości skrawania
AZ	Maksymalna głębokość zagłębienia
B	Szerokość oprawki
BD	Średnica korpusu
BD1	Średnica korpusu 1
BD2	Średnica korpusu 2
BDX	Maksymalna średnica korpusu
BHTA	Kąt połówkowy stożka
BLQ	Kod jakości wyważenia
BN	Szerokość płaszczyzny
CBDP	Głębokość otworu połączenia
CDX	Maksymalna głębokość wcięcia
CEDC	Ilość ostrzy
CHA	Kąt przecięcia otworu
CHW	Szerokość fazy na narożu
CNT	Gwint podłączenia chłodziwa
CW	Szerokość skrawania
CZC	Wielkość połączenia
D1	Średnica otworu
DC	Średnica robocza
DCB	Średnica otworu połączenia
DCBN	Minimalna średnica otworu połączenia
DCBX	Maksymalna średnica otworu połączenia
DCB1	Średnica otworu połączenia 1
DCC	Kod konstrukcji
DCINN	Minimalna wewnętrzna średnica skrawania
DCINX	Maksymalna wewnętrzna średnica skrawania
DCN	Minimalna średnica skrawania
DCON	Średnica połączenia
DCX	Maksymalna średnica skrawania
DF	Średnica kołnierza
DMM	Średnica chwytu
FLGW	Szerokość kołnierza
GAN	Kąt nachylenia płytki
GB	Kąt nachylenia płaszczyzny
HTB	Wysokość korpusu
IC	Średnica okręgu wpisanego
INSD	Średnica płytki
INSL	Długość płytki
KRINS	Kąt główny krawędzi skrawającej
L	Długość krawędzi skrawającej
LB	Długość korpusu
LB1	Długość korpusu 1
LCF	Długość rowka wiórowego
LE	Efektywna długość krawędzi
LF	Długość funkcjonalna
LFS	Drugorzędna długość funkcjonalna
LH	Długość głowicy
LPR	Długość wystawienia
LS	Długość chwytu
LSC	Długość mocowania
LU	Długość użyteczna
LUX	Maksymalna długość użyteczna
M	Wymiar M
OAL	Długość całkowita
RE	Promień naroża
S	Grubość płytki
TDZ	Średnica gwintu
WB	Szerokość korpusu
WF	Szerokość funkcjonalna

PRZEWODNIK

Wiertła Feedmax, Crownloc oraz Performax służą do wiercenia otworów o średnicach 0,1–160 mm (0.004–6.299") z tolerancjami od IT7 do IT12.

Do otworów formowanych podczas odlewania detalu, stosuje się wytaczanie zgrubne lub półwykańczające, za pomocą belki wytaczarskiej lub belki Jumbo.

Co więcej, przy użyciu narzędzi wykańczających do rozwiercania i dokładnego wytaczania można wykonać najwyższej jakości otwory z tolerancjami rzędu IT5 lub IT6.

* Obróbka zgrubna IT9/10, ** Obróbka precyzyjna IT 5/6

Threadmaster DTM, TM, TM2, 396.18 i 396.19;

Tego samego frezu można użyć do gwintu prawego i lewego. Wersja metryczna oraz UN tylko dla gwintów wewnętrznych. Możliwe jest wykonanie dowolnej tolerancji jednym frezem.

Gwintownik Threadmaster:

Gwintowniki oraz nagniatki dostępne dla najpopularniejszych gwintów oraz tolerancji.

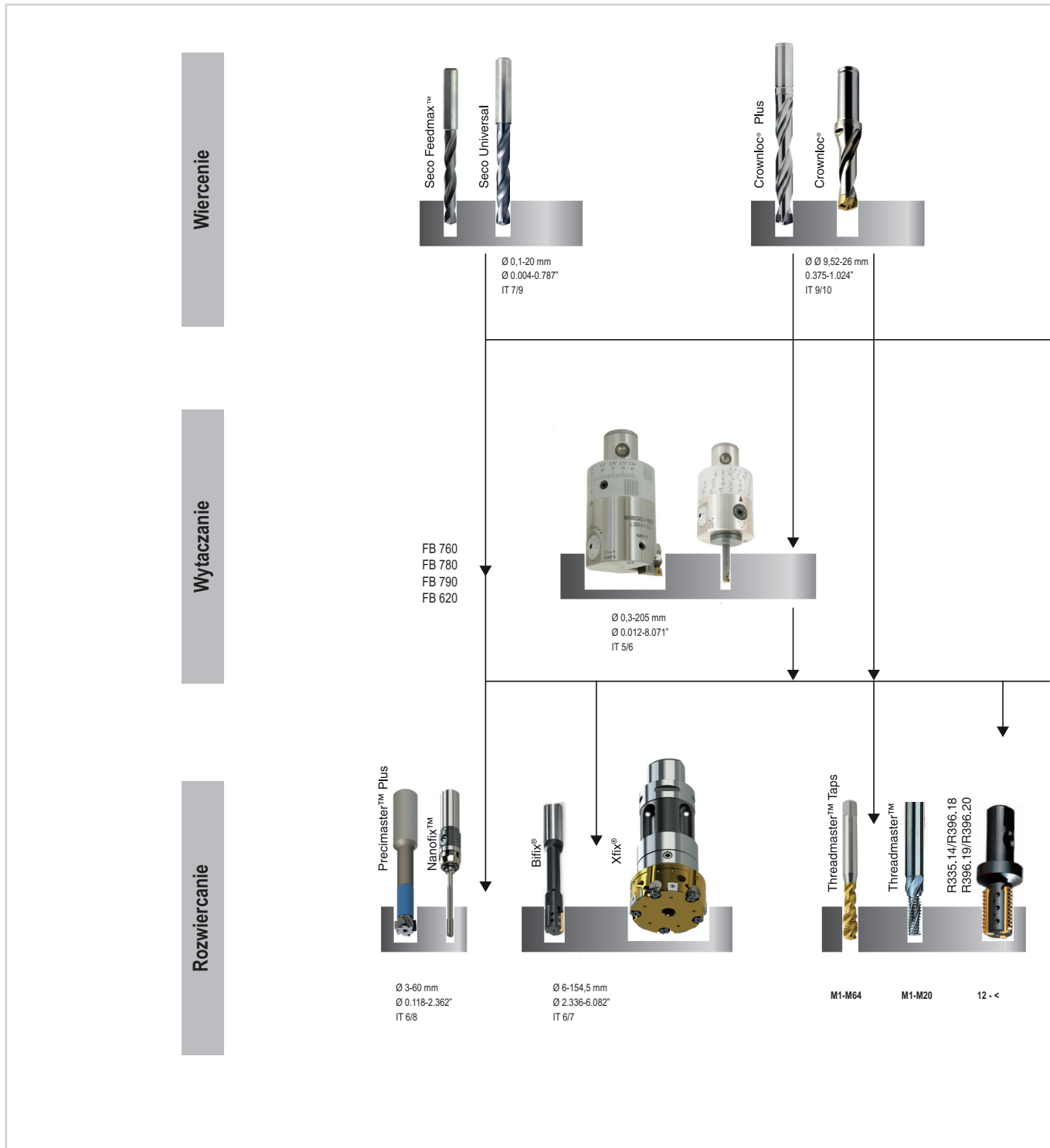

Wstęp

Wiercenie

Rozwiercanie

Wytaczanie

Załącznik

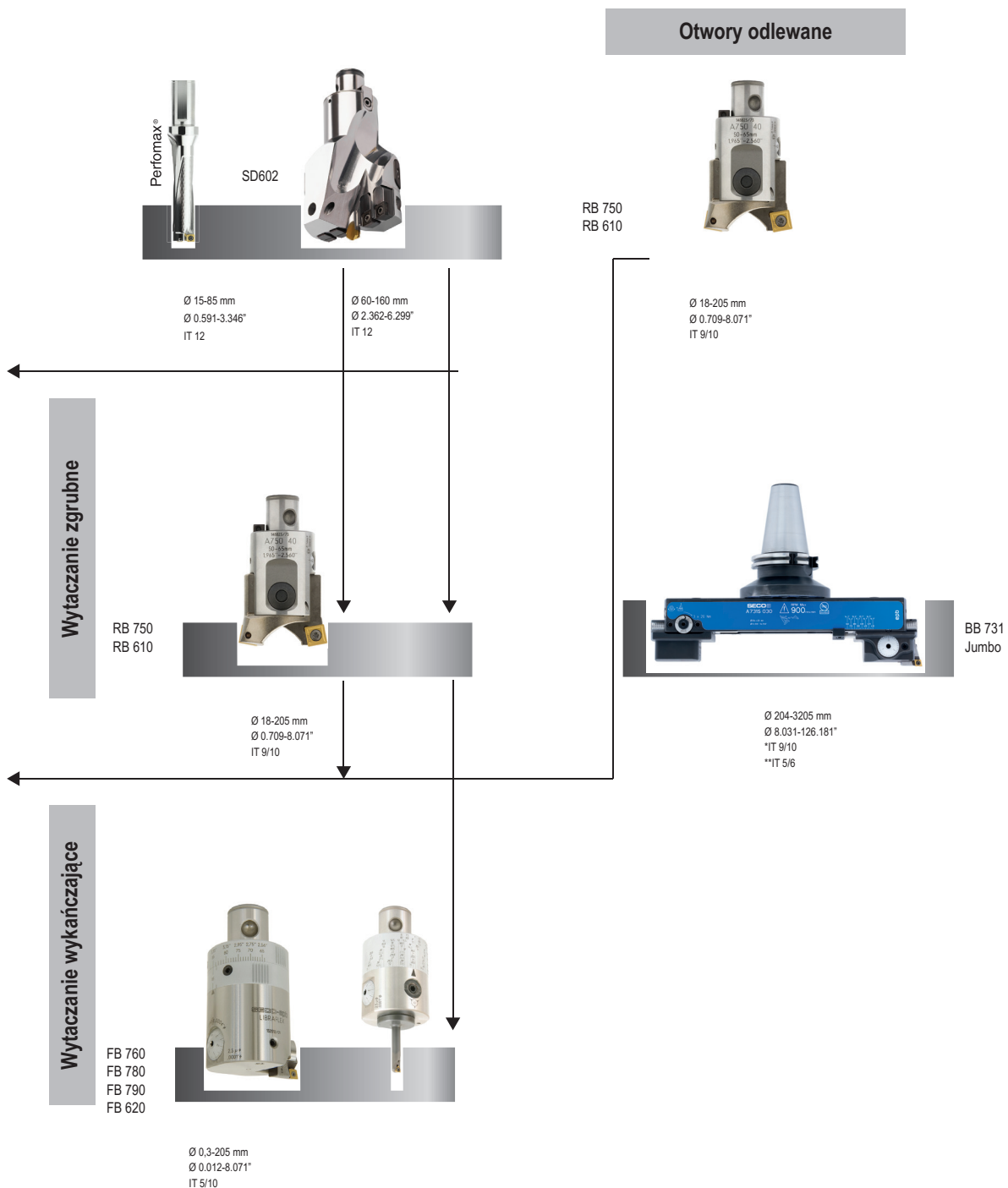

Asortyment wiertel – Wybór wiertła

Seco Feedmax™ Wiertła pełnowęglkowe

**PRODUKTYWNOŚĆ**

- Duże posuwy i prędkości skrawania
- Wąskie tolerancje otworów
- Do stosowania w stabilnych warunkach
- Do wszystkich materiałów

Crownloc® & Crownloc®Plus Wiertła z wymiennymi końcówkami

**ELASTYCZNOŚĆ**

- Wymienne końcówki węglkowe
- Geometrie do obróbki różnych materiałów
- Brak konieczności regeneracji
- Końcówki o kilku średnicach do każdego korpusu

Perfomax® Wiertła płytkowe

**EFEKTYWNOŚĆ KOSZTOWA**

- Gatunki i geometrie do wszystkich obrabianych materiałów
- Płytki kwadratowe minimalizujące koszt na otwór
- Wiercenie, pogłębianie, przecinające się otwory z wejściem lub wyjściem pod kątem, wytaczanie, itp....
- Duże bezpieczeństwo stosowania

SMG – Wprowadzenie

Jako przykład materiałów referencyjnych podano EN C45E dla SMG P4 i EN 42 CrMo 4 dla SMG P5 oraz SMG H5 patrz poniższe informacje.

Klasyfikacja SMG materiałów o określonym standardzie i w określonym stanie przyjętym jako referencyjny w celu ułatwienia dostosowania parametrów dla danego materiału w porównaniu do materiałów referencyjnych Seco. Jako przykłady materiałów referencyjnych podano EN C45E dla SMG P4 i EN 42 CrMo 4 dla SMG P5 oraz SMG H5 patrz tabela 1 poniżej gdzie wskazano referencyjne właściwości materiałów.

Podstawą tabeli SMG klasyfikacja materiałów oparta na ich typie, a nie na względnej obrabialności i w konsekwencji zawiera ona takie materiały jak kompozyty. Jest ona wszechstronna, jednak wciąż łatwo zidentyfikować do której grupy SMG określony materiał należy.

Każda grupa SMG ma przypisany standard materiałowy w stanie określonym jako referencyjny celem ułatwienia dostosowania parametrów dla danego materiału w porównaniu do materiałów referencyjnych, patrz str. 670.681.

SMG	Oznaczenie	Właściwości	Odnosiłnik
P4	Niskostopowe stale konstrukcyjne, 0.25% < C < 0.67%wg Nisko stopowe stale hartowane i odpuszczone	520 < R _m < 1200	C 45E R _m = 660 N/mm ²
P5	Stale konstrukcyjne, 0.25% < C < 0.67%wt Stale hartowane i odpuszczone	550 < R _m < 1200	42 CrMo 4 R _m = 700 N/mm ²

SMG	Oznaczenie	Właściwości	Odnosiłnik
H5	Stale hartowane i odpuszczone	38 < HRC < 56	42 CrMo 4 50 HRC

Skupiając się na EN 42 CrMo 4 w stanie wyżarzonym, wytrzymałość na rozciąganie R_m może zwykle wahać się między R_m = 630 N/mm² i R_m = 780 N/mm², co zostało przyjęte jako poziom referencyjny dla SMG P5.

W stanie hartowanym i odpuszczonym wytrzymałość na rozciąganie R_m zwykle wynosi między R_m = 900 N/mm² a R_m = 1100 N/mm², przez co nadal należy do SMG P5. Jednak jeśli materiał jest hartowany powyżej R_m = 1200 N/mm² wówczas należy do grupy SMG H5.

SMG	EN	W.-Nr	AFNOR	BS	UNI	JIS	AISI / ASTM	GOST	Warunki	R _{m,nom}	HRC _{nom}
P4	42 CrMo 4	1,1201	42 CD 4	708 M 40	42 CrMo 4	SCM 440 (H)	4142, 4140	38HM	Wyżarzane	700	
	42 CrMo 4	1,1201	42 CD 4	708 M 40	42 CrMo 4	SCM 440 (H)	4142, 4140	38HM	Hartowane & odpuszczone	1000	
H5	42 CrMo 4	1,1201	42 CD 4	708 M 40	42 CrMo 4	SCM 440 (H)	4142, 4140	38HM	Hartowane & odpuszczone		45
	42 CrMo 4	1,1201	42 CD 4	708 M 40	42 CrMo 4	SCM 440 (H)	4142, 4140	38HM	Hartowane & odpuszczone		50

Stal EN 42CrMo4 po hartowaniu i odpuszczaniu może posłużyć za przykład do zilustrowania zależności obrabialności od stanu materiału.

Poniższy wykres pokazuje jak zalecana prędkość skrawania dla nominalnego stanu materiału, może być zmieniana zależnie od R_m (lewy wykres obowiązujący dla ISO-P) i zależnie od HRC (obowiązujący dla ISO-H).

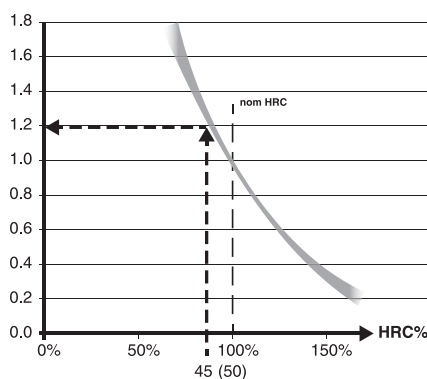
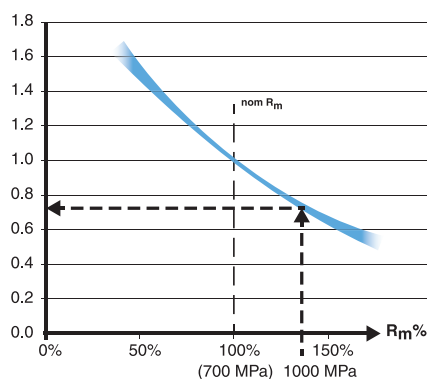

Aby zobrazować, jak dla SMG P5 można dostosować nominalną wartość v_c do dokładniejszej zalecanej wartości v_c, należy określić wartość wytrzymałości na rozciąganie R_m i w tym wypadku zastosować stal EN 42 CrMo 4 po hartowaniu i odpuszczaniu do R_m = 1000 N/mm² zgodnie z powyższą tabelą (pogrubione niebieskie strzałki). Czyli dla SMG P5 nominalna wartość v_c = 280 m/min dla określonej grupy zastosowań.

A zalecana wartość v_c = 280 m/min x 0,75 = 210 m/min. W przypadku grupy SMG H5 nominalna wartość v_c może być dostosowana do stali EN 42 CrMo 4 hartowanej do HRC 45 (mniejsze szare strzałki).

Dla grupy SMG H5 nominalna wartość v_c = 50 m/min przy określonych zastosowaniach i obróbce z wykorzystaniem narzędzi z powlekanego węgla spiekane, wówczas zalecana wartość v_c = 50 m/min x 1,2 = 60 m/min.

Dodatkowe informacje dotyczące materiałów elementów obrabianych można znaleźć na str.670-681 oraz na stronach z zalecanymi parametrami.

Do doboru parametrów skrawania zalecamy narzędzie dostępne w serwisie My Pages – www.secotools.com

Wydajne i uniwersalne rozwiązania

Czego oczekujesz od wiertła węglikowych?

Universal – Uniwersalne wiertła węglikowe

Wiertła Seco Universal są narzędziami do ogólnego przeznaczenia, w szerokim asortymencie materiałów oraz zastosowań w wielu gałęziach przemysłu. Dzięki mocnej samocentrującej się konstrukcji z kątem 140 stopni, polerowanym rowkom wiórowym oraz doskonałej jakości - uzyskujemy wysokie bezpieczeństwo stosowania i uniwersalność przy bardzo niskim koszcie. Z wiertłami Seco Universal możesz zredukować koszty magazynowe i uzyskasz lepszą elastyczność obróbki, oraz redukcję przestoju obrabiarek. Wiertła Seco Universal są alternatywą dla Seco Feedmax™ w zastosowaniach gdzie wymagana jest uniwersalność i elastyczność oraz ważna jest redukcja kosztów.

MRR, Szybkość usuwania materiału (cm³ / min)

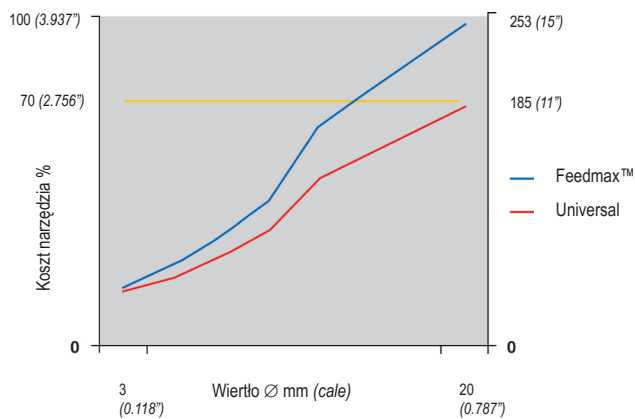

Trwałość, małe parametry

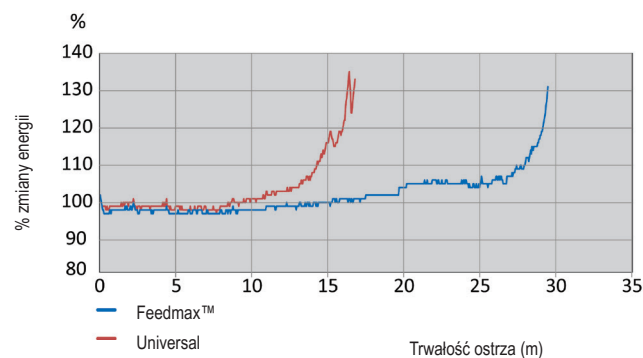

Pierwszy otwór jest otworem referencyjnym, 100% na podstawie mocy wrzeczona
 Parametry skrawania
 $V_c = 90$ m/min
 $f = 0,15$ mm/obr.

$v_c = 295$ sf/min
 $f = 0,006$ cala/obr.

Materiał = SMG P5-P6, SS2244, DIN41CrMo4, AISI 4140

Feedmax™ – Wysokowydajne wiertła węglikowe

Feedmax™ oferuje unikatową kombinację substratu, pokrycia oraz geometrii. Wiertła Feedmax™ zaprojektowano celem zapewnienia dużej produktywności i małych kosztów na otwór przy dużych posuwach 0,70 mm/obr. (0.028 cala/obrót) oraz wysokich prędkościach skrawania 220 m/min (720 sf/min). Wiertło oferuje doskonałe centrowanie - wysoka jakość otworu jest uzyskiwana bez konieczności nawiercania. Dzięki nowoczesnemu pokryciu o dużej twardości na gorąco, mocnym krawędziom skrawającym z fazą zabezpieczającą, wytrzymałemu węglikowi, doskonałym możliwościom ewakuacji wiórów i jakości krawędzi skrawającej - wiertło oferuje długą i przewidywalną trwałość. Wiertła Seco Feedmax™ oferują szeroki asortyment optymalnych geometrii do różnych materiałów i zastosowań, dzięki temu uzyskujemy dobrą jakość otworu przy niskim koszcie.

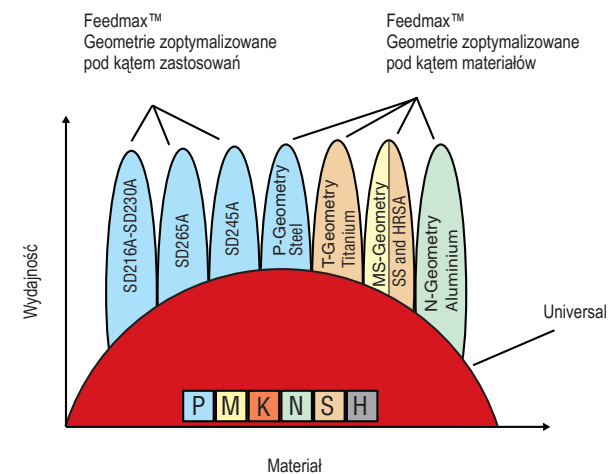

Trwałość, wysokie parametry

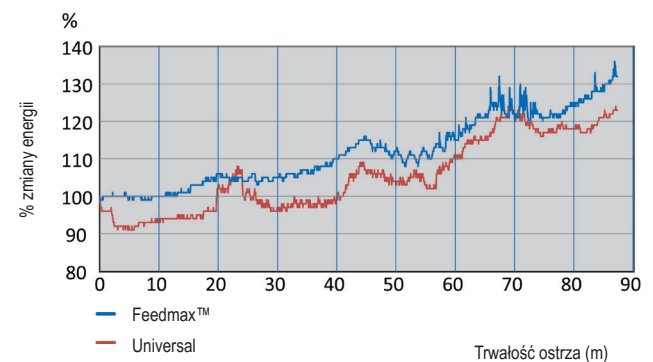

Pierwszy otwór jest otworem referencyjnym, 100% na podstawie mocy wrzeczona
 Parametry skrawania
 $V_c = 160$ m/min
 $f = 0,24$ mm/obr.

$v_c = 525$ sf/min
 $f = 0,009$ cala/obr.

Materiał = SMG P5-P6, SS2244, DIN41CrMo4, AISI 4140

Wstęp

Wiercenie

Rozwiercanie

Wyłaczanie

Załącznik







Przegląd asortymentu

Universal	Zakres \varnothing	Głębokość wiercenia	Tolerancja \varnothing otworu	Tolerancja otworu (1)	Wykończenie powierzchni (2)
SD1103  Str. - 26, 27, 28, 29, 30, 31	3-20 mm (0.118-0.787")	~ 3 x D	m7	IT 8-9	Ra 1-2 μm (Ra 39-79 μin)
SD1103A  Str. - 32, 33, 34, 35, 36, 37	3-20 mm (0.118-0.787")	~ 3 x D	m7	IT 8-9	Ra 1-2 μm (Ra 39-79 μin)
SD1105A  Str. - 38, 39, 40, 41, 42, 43, 44, 45	3-20 mm (0.118-0.787")	~ 5 x D	m7	IT 8-9	Ra 1-3 μm (Ra 39-118 μin)
SD1108A  Str. - 46, 47, 48, 49, 50	3-20 mm (0.118-0.787")	~ 8 x D	m7	IT 9	Ra 1-3 μm (Ra 39-118 μin)
SD1112A  Str. - 51, 52, 53, 54	3-20 mm (0.118-0.787")	~ 12 x D	m7	IT 9	Ra 1-3 μm (Ra 39-118 μin)

1) mogą wystąpić różnice w zależności od materiału i stosowanych parametrów.

2) głębokość wiercenia, parametry, ciśnienie chłodziwa i materiał mogą spowodować pogorszenie wykończenia powierzchni.



Przegląd asortymentu

Feedmax™	Zakres \varnothing	Głębokość wiercenia	Tolerancja \varnothing otworu	Tolerancja otworu (1)	Wykończenie powierzchni (2)
SD203A-P  Str. - 56, 57, 58, 59, 60, 61	2-20 mm (0.078-0.787")	~ 3 x D	m7	IT 8-9	Ra 1-2 μm (Ra 39-79 μin)
SD205A-P  Str. - 62, 63, 64, 65, 66, 67, 68, 69	2-20 mm (0.078-0.787")	~ 5 x D	m7	IT 8-9	Ra 1-2 μm (Ra 39-79 μin)
SD206, SD206A  Str. - 70, 71	0,7-2,0 mm (0.027-0.078")	~ 6 x D	h6	IT 9	Ra 1-2 μm (Ra 39-79 μin)
SD207A-P  Str. - 72, 73, 74	3-20 mm (0.118-0.787")	~ 7 x D	m7	IT 9	Ra 1-3 μm (Ra 39-118 μin)
SD216A  Str. - 75	3-12 mm (0.118-0.472")	~ 16 x D	m7	IT 9	Ra 1-3 μm (Ra 39-118 μin)
SD230A  Str. - 76	4-10 mm (0.157-0.393")	~ 30 x D	m7	IT 9	Ra 1-3 μm (Ra 39-118 μin)

1) mogą wystąpić różnice w zależności od materiału i stosowanych parametrów.

2) głębokość wiercenia, parametry, ciśnienie chłodziwa i materiał mogą spowodować pogorszenie wykończenia powierzchni.

Przegląd asortymentu

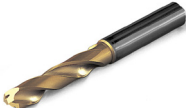
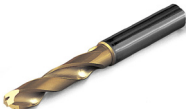
Feedmax™	Zakres \varnothing	Głębokość wiercenia	Tolerancja \varnothing otworu	Tolerancja otworu (1)	Wykończenie powierzchni (2)
SD245A 	5-14 mm (0.196-0.551")	~ 5 x D	m7	IT 8	Ra 1-2 μm (Ra 39-79 μin)
Str. - 78, 79					
SD265A 	6-16 mm (0.236-0.630")	~ 5 x D	js6	IT 7	Ra 1-2 μm (Ra 39-79 μin)
Str. - 81					
SD203A-MS Superstopy 	2-20 mm (0.079-0.551")	~ 3 x D	m7	IT 8-9	Ra 1-2 μm (Ra 39-79 μin)
Str. - 88, 89, 90, 91, 92					
SD205A-MS Superstopy 	2-20 mm (0.079-0.551")	~ 5 x D	m7	IT 8-9	Ra 1-2 μm (Ra 39-79 μin)
Str. - 93, 94, 95, 96					
SD203A-M 	3-20 mm (0.098-0.551")	~ 3 x D	m7	IT 8-9	Ra 1-2 μm (Ra 39-79 μin)
Str. - 97, 98, 99					
SD205A-M 	3-20 mm (0.098-0.551")	~ 5 x D	m7	IT 8-9	Ra 1-2 μm (Ra 39-79 μin)
Str. - 100, 101, 102					

1) mogą wystąpić różnice w zależności od materiału i stosowanych parametrów.

2) głębokość wiercenia, parametry, ciśnienie chłodziwa i materiał mogą spowodować pogorszenie wykończenia powierzchni.

Wstęp





Wiercenie

Rozwiercanie

Wylaczanie

Zalącznik

Przegląd asortymentu

Feedmax™	Zakres \varnothing	Głębokość wiercenia	Tolerancja \varnothing otworu	Tolerancja otworu (1)	Wykończenie powierzchni (2)
 <p>SD203A-T, SD205A-T</p> <p>Str. - 103, 104</p>	3-20 mm (0.118-0.787")	~ 3 x D, ~ 5 x D	m7	IT 8-9	Ra 1-2 μ m (Ra 39-79 μ in)
 <p>SD203A-N</p> <p>Str. - 105, 106</p>	3-20 mm (0.118-0.787")	~ 3 x D	m7	IT 8-9	Ra 1-2 μ m (Ra 39-79 μ in)
 <p>SD205A-C1, -C2</p> <p>Str. - 110-111</p>	3,2-12,7 mm (0.125-0.500")	~ 5 x D	m7	IT 9	-
 <p>SD203-CX1</p> <p>Str. - 112</p>	3,26-9,53 mm (0.128-0.375")	~ 5 x D	m7	IT 9	-
 <p>SD22</p> <p>Str. - 114, 115, 116, 117, 118, 119, 120</p>	0,1-2,0 mm (0.004-0.079")	~ 2 x D	0,005/0 mm (+0.0002"/0)	-	-
 <p>SD26</p> <p>Str. - 121, 122, 123, 124, 125, 126, 127</p>	0,1-2,0 mm (0.004-0.079")	~ 6 x D	0/-0,004 mm (0/-0.00016")	-	-

1) mogą wystąpić różnice w zależności od materiału i stosowanych parametrów.

2) głębokość wiercenia, parametry, ciśnienie chłodziwa i materiał mogą spowodować pogorszenie wykończenia powierzchni.

Oznaczenia

Universal

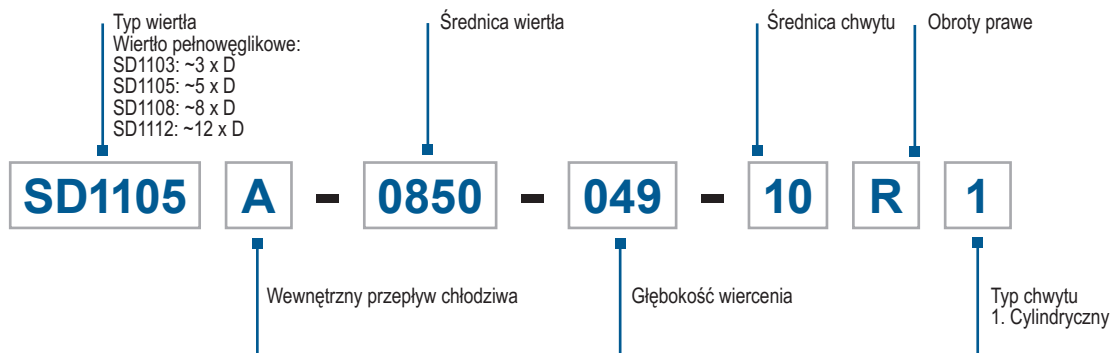

Feedmax™

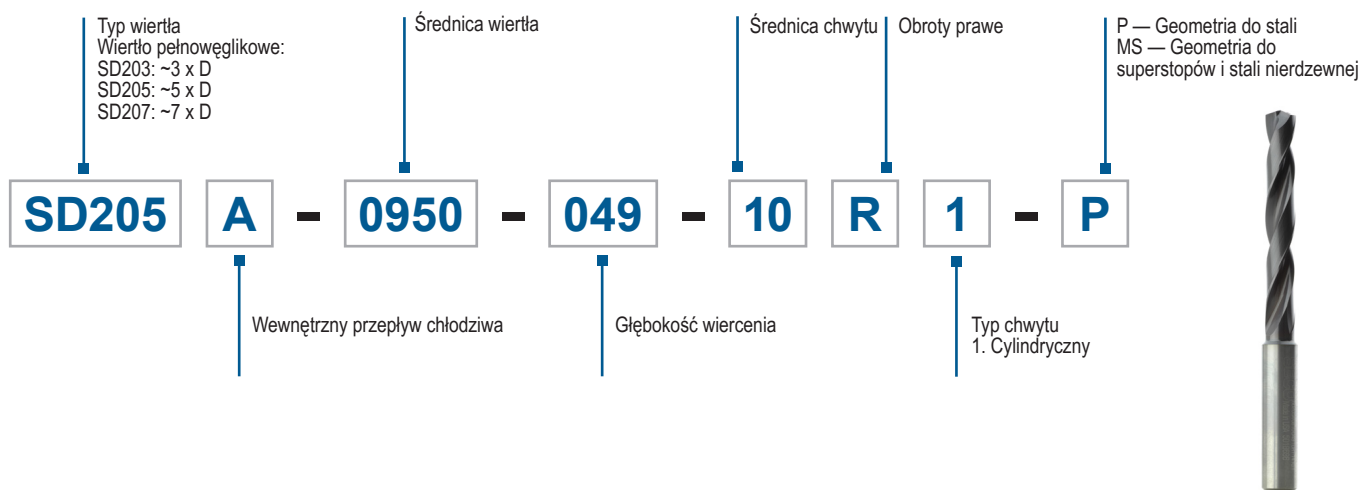

Feedmax™

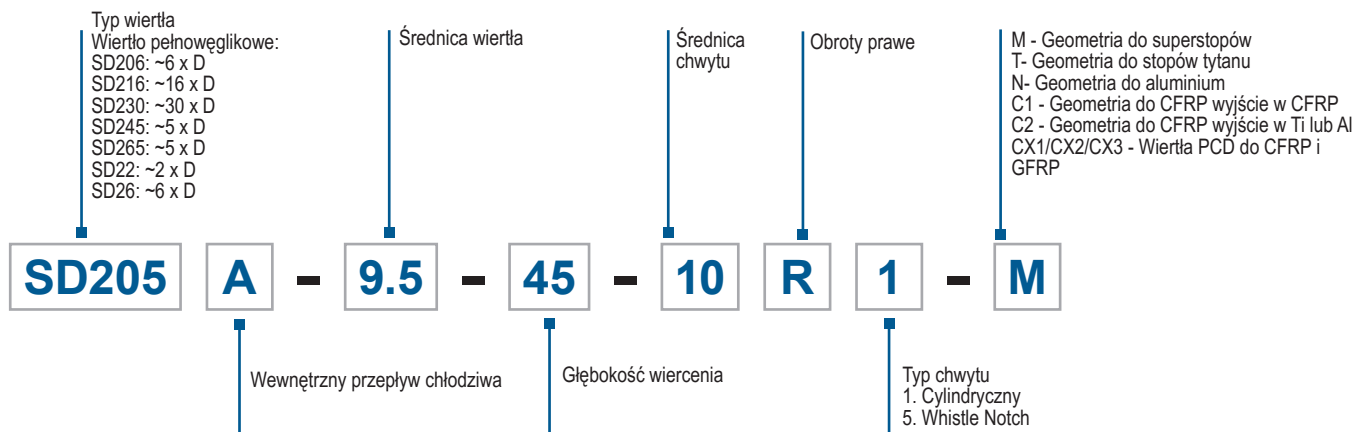

Ustawianie

Mocowanie/bicie

Wiertła z chwytami cylindrycznymi można mocować w oprawkach Shrinkfit, hydraulicznych lub w tulejkach zaciskowych. Całkowite bicie dla wiertel powinno wynosić 0,04 (0.0016") mm mierzone na wrzecionie. Dla uzyskania dobrego rezultatu bicie powinno mieścić się w granicach 0,02 mm (0.0008").

Stabilność

Stabilność obróbki bardzo mocno wpływa na trwałość ostrza oraz dokładność otworu. Należy sprawdzić stan wrzeciona obrabiarki, przyrządu oraz zamocowanie detalu dla zapewnienia maksymalnej stabilności i sztywności. Niestabilne warunki mogą spowodować złamanie narzędzia.

Trwałość narzędzia

Nie należy stosować wiertel o zużyciu na powierzchni przyłożenia przekraczającym 0,1–0,3 mm (0.004–0.012") w największym punkcie.

Zalecane oprawki

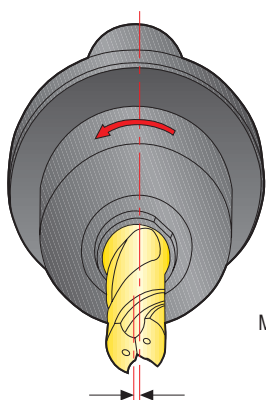

Maks. 0,04 mm (0.0016")

Poniższe oprawki zapewnią najlepsze rezultaty:
 Typ 5603 - oprawki Shrinkfit, typ DIN
 Typ 5834 - oprawki hydrauliczne
 Typ 5672 - oprawki na precyzyjne tulejki zaciskowe
 Więcej informacji szukaj w katalogu Systemy Narzędziowe EPB

0,1-0,3 mm (0.004-0.012")

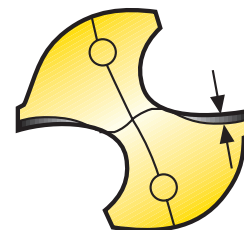

Oprawki Shrinkfit

(Tylko dla chwytów cylindrycznych R1)



Oprawka hydrauliczna

(Tylko dla chwytów cylindrycznych R1)



Oprawki na precyzyjne tulejki zaciskowe

(Tylko dla chwytów cylindrycznych R1)

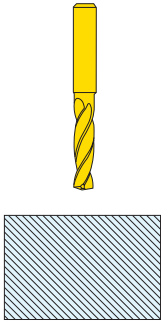
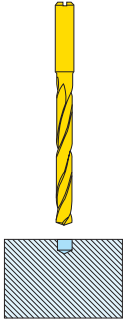
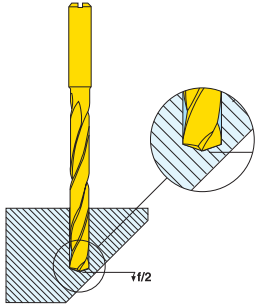
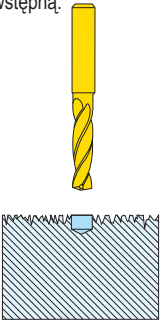
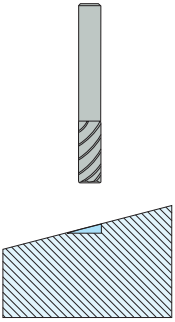
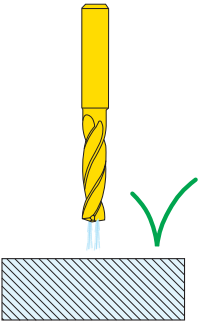
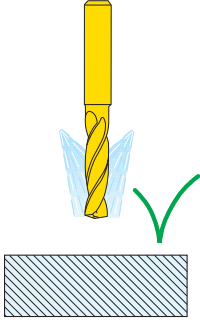

Metody obróbki

Wejście w materiał na obrobionej powierzchni		Wyjście z otworu pod kątem
<p>3-15 x D</p>  <p>Brak potrzeby nawierciana lub redukcji posuwu na wejściu.</p>	<p>> 16 x D</p>  <p>Przy stosowaniu dłuższych wiertel zalecane jest wstępne wiercenie.</p>	<p>Przed wyjściem z otworu zredukować posuw/obr o 50%.</p>  <p>Lub zastosowanie wiertła SD245A.</p>
Nieregularne/Kątowe wejście w materiał		
<p>Jeśli wejście w mat. jest nieregularne lub pod kątem, należy wykonać operację wstępną.</p>  <p>Regulame wejście w materiał</p> <p>Wiercenie wstępne krótkim wiertłem Feedmax</p>	<p>Obróbka wstępna alternatywy</p>  <p>Kątowe wej. w materiał</p> <p>Wykonanie pogłębienia frezem walcowo-czołowym.</p>	
Zalecenia dotyczące chłodzenia		
<p>1.</p>  <p>Pierwszy wybór</p>	<p>2.</p>  <p>≤ 5 x D</p>	<p>1. Ciśnienie chłodziwa*</p> <p>Minimalne zalecane ciśnienie to 10 bar przy ≤ 5 x D Minimalne zalecane ciśnienie to 30 bar przy > 5 x D Minimalne zalecane ciśnienie to 40 bar przy > 16 x D</p> <p>2. Koncentracja emulsji</p> <p>Zalecane koncentracja emulsji 6-8%. Przy wierceniu w stali nierdz., superstopach i stali o dużej wytrzymał. zaleca się stężenie emulsji 10%.</p>

* Przy zastosowaniu niższego ciśnienia, należy odpowiednio zredukować parametry.

Metody obróbki

SD216A (16 x D) do SD230A (30 x D) — ETAPY

1.

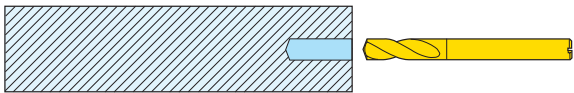

1. Wiercić otwór wstępnie 2-3 x D. Zastosować wiertło standardowe o tej samej średnicy np. SD203A lub SD1103 (o kącie 140°)

2.

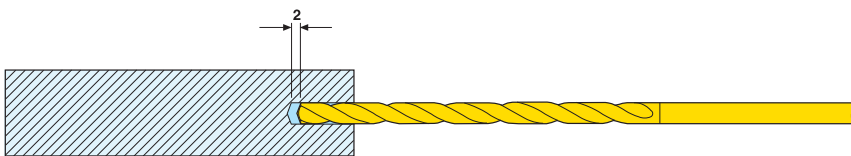

2. Wejść w otwór przy zatrzymanych obrotach lub bardzo małych (500 obr.). Zatrzymać się 2 mm (0.080") nad dnem otworu.

3.

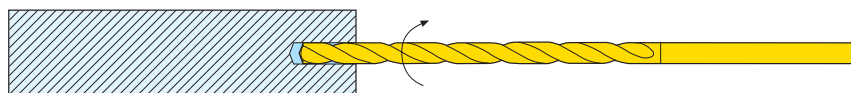

3. Włączyć obroty i chłodzenie, wiercić stosując zalecane parametry. (Nie robić odwiórowania).

4.

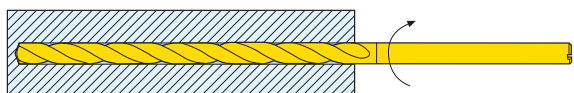

4. Po osiągnięciu pełnej głębokości, zredukować obroty do 500 i wyjechać z otworu z posuwem 4 x większym od posuwu roboczego celem uniknięcia śladów.

Metody obróbki – Mikro wiertła

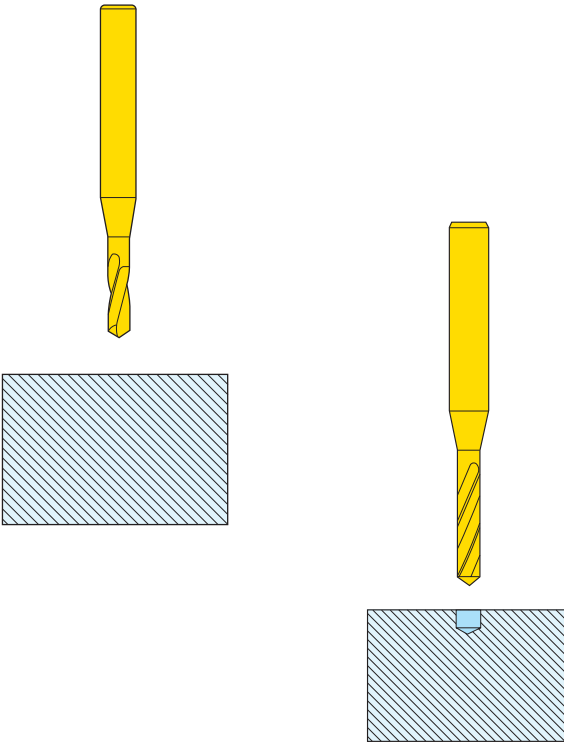
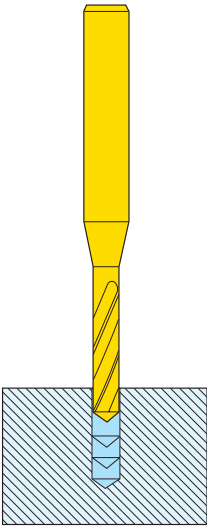
Otwór wiercony wstępnie	
	SD22 Dla uzyskania optymalnej tolerancji oraz dokładności położenia otworu, stosować wiertło prowadzące SD22.
	SD26 Poniżej średnicy 1 mm (0.039") stanowczo zaleca się stosować wiertło prowadzące.
Odwiórowanie	
	Do materiałów dających długi wiór, należy stosować odwiórowanie. Generalnie 1 odwiórowanie co głębokość 1 x D.

Instrukcja montażu modułu fazującego

1.

2.

3.

4.

Maksymalna głębokość fazy

maks.
2,8 mm
(0.110")

Średnica wiertła DC		LU głębokość wiercenia (min-maks)					
		SD1103 / SD203A		SD1105 / SD205A		SD207A	
mm	cal.	mm	cal.	mm	cal.	mm	cal.
4,00-4,75	.157-.187	4-17	.157-.669	10-27	.394-1.063	30-45	1.181-1.772
4,76-6,00	.187-.236	6-20	.236-.787	18-32	.709-1.260	30-45	1.181-1.772
6,01-8,00	.241-.315	15-27	.590-1.063	28-42	1.102-1.653	42-57	1.653-2.244
8,01-10,00	.315-.394	17-31	.669-1.220	34-48	1.338-1.890	47-62	1.850-2.441
10,01-12,00	.394-.472	21-36	.826-1.417	40-56	1.575-2.205	57-72	2.244-2.835
12,01-14,00	.473-.551	22-37	.866-1.457	43-59	1.693-2.323	68-83	2.677-3.268
14,01-16,00	.552-.630	23-39	.906-1.535	44-60	1.732-2.362	76-92	2.992-3.622

Stosować tylko z chwytem cylindrycznym (R1).

Wstęp

Wiercenie

Rozwiercanie

Wyłaczanie

Załącznik



Seco Universal — wiertła do pojedynczej średnicy

Wiertła Seco Universal z węgla spiekanego to ekonomiczne i wszechstronne rozwiązanie, które idealnie nadaje się do produkcji małych i średnich partii. Wiertła Seco Universal sprawdzają się w większości zastosowań we wszystkich branżach.

- Uniwersalna geometria z 4 fasetami zapewniająca doskonałe centrowanie
- Powłoka TiAlN o wysokiej odporności na zużycie gwarantuje dużą trwałość narzędzia
- Możliwość stosowania z gwintownikami Threadmaster™ oraz w operacjach wstępnego wiercenia z wykorzystaniem narzędzi Nanofix™ Precimaster™ Plus

SD1103

Głębokość wiercenia ~ 3 x D – Metryczne/Calowe

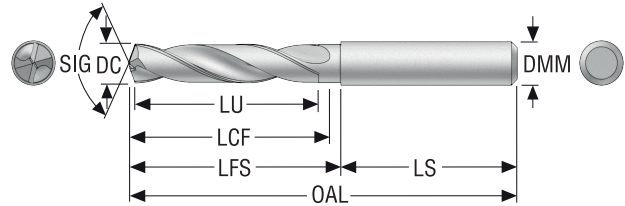
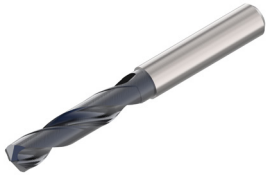

- Chwyt cylindryczny DIN 6537A
- Tolerancja DC m7
- Zewnętrzne kanały doprowadzające chłodziwo
- Parametry skrawania, patrz strona (strony) 139
- Średnice pośrednie patrz aplikacja MyDesign.

Oznaczenie	Numer produktu	DC	LU	OAL	LFS	LS	LCF	DMM	Kąt wierzchołkowy	Pokrycie	Tolerancja otworu
		mm Cal.	mm Cal.	mm Cal.	mm Cal.	mm Cal.	mm Cal.	mm Cal.			
SD1103-0300-014-06R1 SD_DRILL_3.0MM_3XD	02898974	3,0 0.118	14,0 0.551	62,0 2.441	26,0 1.024	36,0 1.417	20,0 0.787	6,0 0.236	140°	TiAIN	IT9
SD1103-0310-014-06R1 SD_DRILL_3.1MM_3XD	02898975	3,1 0.122	14,0 0.551	62,0 2.441	26,0 1.024	36,0 1.417	20,0 0.787	6,0 0.236	140°	TiAIN	IT9
SD1103-0318-014-06R1 SD_DRILL_1/8_3XD	02898976	3,175 0.125	14,0 0.551	62,0 2.441	26,0 1.024	36,0 1.417	20,0 0.787	6,0 0.236	140°	TiAIN	IT9
SD1103-0320-014-06R1 SD_DRILL_3.2MM_3XD	02898977	3,2 0.126	14,0 0.551	62,0 2.441	26,0 1.024	36,0 1.417	20,0 0.787	6,0 0.236	140°	TiAIN	IT9
SD1103-0325-014-06R1 SD_DRILL_3.25MM_3XD	02898978	3,25 0.128	14,0 0.551	62,0 2.441	26,0 1.024	36,0 1.417	20,0 0.787	6,0 0.236	140°	TiAIN	IT9
SD1103-0330-014-06R1 SD_DRILL_3.3MM_3XD	02898979	3,3 0.130	14,0 0.551	62,0 2.441	26,0 1.024	36,0 1.417	20,0 0.787	6,0 0.236	140°	TiAIN	IT9
SD1103-0340-014-06R1 SD_DRILL_3.4MM_3XD	02898980	3,4 0.134	14,0 0.551	62,0 2.441	26,0 1.024	36,0 1.417	20,0 0.787	6,0 0.236	140°	TiAIN	IT9
SD1103-0350-014-06R1 SD_DRILL_3.5MM_3XD	02898981	3,5 0.138	14,0 0.551	62,0 2.441	26,0 1.024	36,0 1.417	20,0 0.787	6,0 0.236	140°	TiAIN	IT9
SD1103-0357-014-06R1 SD_DRILL_9/64_3XD	02898982	3,572 0.141	14,0 0.551	62,0 2.441	26,0 1.024	36,0 1.417	20,0 0.787	6,0 0.236	140°	TiAIN	IT9
SD1103-0360-014-06R1 SD_DRILL_3.6MM_3XD	02898983	3,6 0.142	14,0 0.551	62,0 2.441	26,0 1.024	36,0 1.417	20,0 0.787	6,0 0.236	140°	TiAIN	IT9
SD1103-0365-014-06R1 SD_DRILL_3.65MM_3XD	02898984	3,65 0.144	14,0 0.551	62,0 2.441	26,0 1.024	36,0 1.417	20,0 0.787	6,0 0.236	140°	TiAIN	IT9
SD1103-0370-014-06R1 SD_DRILL_3.7MM_3XD	02898985	3,7 0.146	14,0 0.551	62,0 2.441	26,0 1.024	36,0 1.417	20,0 0.787	6,0 0.236	140°	TiAIN	IT9
SD1103-0380-017-06R1 SD_DRILL_3.8MM_3XD	02898986	3,8 0.150	17,0 0.669	66,0 2.598	30,0 1.181	36,0 1.417	24,0 0.945	6,0 0.236	140°	TiAIN	IT9
SD1103-0390-017-06R1 SD_DRILL_3.9MM_3XD	02898987	3,9 0.154	17,0 0.669	66,0 2.598	30,0 1.181	36,0 1.417	24,0 0.945	6,0 0.236	140°	TiAIN	IT9
SD1103-0397-017-06R1 SD_DRILL_5/32_3XD	02898988	3,969 0.156	17,0 0.669	66,0 2.598	30,0 1.181	36,0 1.417	24,0 0.945	6,0 0.236	140°	TiAIN	IT9
SD1103-0400-017-06R1 SD_DRILL_4.0MM_3XD	02898989	4,0 0.157	17,0 0.669	66,0 2.598	30,0 1.181	36,0 1.417	24,0 0.945	6,0 0.236	140°	TiAIN	IT9
SD1103-0410-017-06R1 SD_DRILL_4.1MM_3XD	02898990	4,1 0.161	17,0 0.669	66,0 2.598	30,0 1.181	36,0 1.417	24,0 0.945	6,0 0.236	140°	TiAIN	IT9
SD1103-0420-017-06R1 SD_DRILL_4.2MM_3XD	02898991	4,2 0.165	17,0 0.669	66,0 2.598	30,0 1.181	36,0 1.417	24,0 0.945	6,0 0.236	140°	TiAIN	IT9
SD1103-0430-017-06R1 SD_DRILL_4.3MM_3XD	02898992	4,3 0.169	17,0 0.669	66,0 2.598	30,0 1.181	36,0 1.417	24,0 0.945	6,0 0.236	140°	TiAIN	IT9
SD1103-0437-017-06R1 SD_DRILL_11/64_3XD	02898993	4,366 0.172	17,0 0.669	66,0 2.598	30,0 1.181	36,0 1.417	24,0 0.945	6,0 0.236	140°	TiAIN	IT9
SD1103-0440-017-06R1 SD_DRILL_4.4MM_3XD	02898994	4,4 0.173	17,0 0.669	66,0 2.598	30,0 1.181	36,0 1.417	24,0 0.945	6,0 0.236	140°	TiAIN	IT9

Wstęp

Wiercenie

Rozwiercanie

Wytyczanie

Załącznik

Oznaczenie	Numer produktu	DC	LU	OAL	LFS	LS	LCF	DMM	Kąt wierzchołkowy	Pokrycie	Tolerancja otworu
		mm Cal.	mm Cal.	mm Cal.	mm Cal.	mm Cal.	mm Cal.	mm Cal.	mm Cal.		
SD1103-0450-017-06R1 SD_DRILL_4.5MM_3XD	02898995	4,5 0.177	17,0 0.669	66,0 2.598	30,0 1.181	36,0 1.417	24,0 0.945	6,0 0.236	140°	TiAIN	IT9
SD1103-0460-017-06R1 SD_DRILL_4.6MM_3XD	02898996	4,6 0.181	17,0 0.669	66,0 2.598	30,0 1.181	36,0 1.417	24,0 0.945	6,0 0.236	140°	TiAIN	IT9
SD1103-0465-017-06R1 SD_DRILL_4.65MM_3XD	02898997	4,65 0.183	17,0 0.669	66,0 2.598	30,0 1.181	36,0 1.417	24,0 0.945	6,0 0.236	140°	TiAIN	IT9
SD1103-0470-017-06R1 SD_DRILL_4.7MM_3XD	02898998	4,7 0.185	17,0 0.669	66,0 2.598	30,0 1.181	36,0 1.417	24,0 0.945	6,0 0.236	140°	TiAIN	IT9
SD1103-0476-020-06R1 SD_DRILL_3/16_3XD	02898999	4,763 0.188	20,0 0.787	66,0 2.598	30,0 1.181	36,0 1.417	28,0 1.102	6,0 0.236	140°	TiAIN	IT9
SD1103-0480-020-06R1 SD_DRILL_4.8MM_3XD	02899000	4,8 0.189	20,0 0.787	66,0 2.598	30,0 1.181	36,0 1.417	28,0 1.102	6,0 0.236	140°	TiAIN	IT9
SD1103-0490-020-06R1 SD_DRILL_4.9MM_3XD	02899001	4,9 0.193	20,0 0.787	66,0 2.598	30,0 1.181	36,0 1.417	28,0 1.102	6,0 0.236	140°	TiAIN	IT9
SD1103-0500-020-06R1 SD_DRILL_5.0MM_3XD	02899002	5,0 0.197	20,0 0.787	66,0 2.598	30,0 1.181	36,0 1.417	28,0 1.102	6,0 0.236	140°	TiAIN	IT9
SD1103-0510-020-06R1 SD_DRILL_5.1MM_3XD	02899003	5,1 0.201	20,0 0.787	66,0 2.598	30,0 1.181	36,0 1.417	28,0 1.102	6,0 0.236	140°	TiAIN	IT9
SD1103-0516-020-06R1 SD_DRILL_13/64_3XD	02899004	5,159 0.203	20,0 0.787	66,0 2.598	30,0 1.181	36,0 1.417	28,0 1.102	6,0 0.236	140°	TiAIN	IT9
SD1103-0520-020-06R1 SD_DRILL_5.2MM_3XD	02899005	5,2 0.205	20,0 0.787	66,0 2.598	30,0 1.181	36,0 1.417	28,0 1.102	6,0 0.236	140°	TiAIN	IT9
SD1103-0530-020-06R1 SD_DRILL_5.3MM_3XD	02899006	5,3 0.209	20,0 0.787	66,0 2.598	30,0 1.181	36,0 1.417	28,0 1.102	6,0 0.236	140°	TiAIN	IT9
SD1103-0540-020-06R1 SD_DRILL_5.4MM_3XD	02899007	5,4 0.213	20,0 0.787	66,0 2.598	30,0 1.181	36,0 1.417	28,0 1.102	6,0 0.236	140°	TiAIN	IT9
SD1103-0550-020-06R1 SD_DRILL_5.5MM_3XD	02899008	5,5 0.217	20,0 0.787	66,0 2.598	30,0 1.181	36,0 1.417	28,0 1.102	6,0 0.236	140°	TiAIN	IT9
SD1103-0555-020-06R1 SD_DRILL_5.55MM_3XD	02899009	5,55 0.219	20,0 0.787	66,0 2.598	30,0 1.181	36,0 1.417	28,0 1.102	6,0 0.236	140°	TiAIN	IT9
SD1103-0556-020-06R1 SD_DRILL_7/32_3XD	02899010	5,556 0.219	20,0 0.787	66,0 2.598	30,0 1.181	36,0 1.417	28,0 1.102	6,0 0.236	140°	TiAIN	IT9
SD1103-0560-020-06R1 SD_DRILL_5.6MM_3XD	02899011	5,6 0.220	20,0 0.787	66,0 2.598	30,0 1.181	36,0 1.417	28,0 1.102	6,0 0.236	140°	TiAIN	IT9
SD1103-0570-020-06R1 SD_DRILL_5.7MM_3XD	02899012	5,7 0.224	20,0 0.787	66,0 2.598	30,0 1.181	36,0 1.417	28,0 1.102	6,0 0.236	140°	TiAIN	IT9
SD1103-0580-020-06R1 SD_DRILL_5.8MM_3XD	02899013	5,8 0.228	20,0 0.787	66,0 2.598	30,0 1.181	36,0 1.417	28,0 1.102	6,0 0.236	140°	TiAIN	IT9
SD1103-0590-020-06R1 SD_DRILL_5.9MM_3XD	02899014	5,9 0.232	20,0 0.787	66,0 2.598	30,0 1.181	36,0 1.417	28,0 1.102	6,0 0.236	140°	TiAIN	IT9
SD1103-0595-020-06R1 SD_DRILL_15/64_3XD	02899015	5,953 0.234	20,0 0.787	66,0 2.598	30,0 1.181	36,0 1.417	28,0 1.102	6,0 0.236	140°	TiAIN	IT9
SD1103-0600-020-06R1 SD_DRILL_6.0MM_3XD	02899016	6,0 0.236	20,0 0.787	66,0 2.598	30,0 1.181	36,0 1.417	28,0 1.102	6,0 0.236	140°	TiAIN	IT9
SD1103-0610-024-08R1 SD_DRILL_6.1MM_3XD	02899017	6,1 0.240	24,0 0.945	79,0 3.110	43,0 1.693	36,0 1.417	34,0 1.339	8,0 0.315	140°	TiAIN	IT9
SD1103-0620-024-08R1 SD_DRILL_6.2MM_3XD	02899018	6,2 0.244	24,0 0.945	79,0 3.110	43,0 1.693	36,0 1.417	34,0 1.339	8,0 0.315	140°	TiAIN	IT9
SD1103-0630-024-08R1 SD_DRILL_6.3MM_3XD	02899019	6,3 0.248	24,0 0.945	79,0 3.110	43,0 1.693	36,0 1.417	34,0 1.339	8,0 0.315	140°	TiAIN	IT9
SD1103-0635-024-08R1 SD_DRILL_1/4_3XD	02899020	6,35 0.250	24,0 0.945	79,0 3.110	43,0 1.693	36,0 1.417	34,0 1.339	8,0 0.315	140°	TiAIN	IT9
SD1103-0640-024-08R1 SD_DRILL_6.4MM_3XD	02899021	6,4 0.252	24,0 0.945	79,0 3.110	43,0 1.693	36,0 1.417	34,0 1.339	8,0 0.315	140°	TiAIN	IT9
SD1103-0650-024-08R1 SD_DRILL_6.5MM_3XD	02899022	6,5 0.256	24,0 0.945	79,0 3.110	43,0 1.693	36,0 1.417	34,0 1.339	8,0 0.315	140°	TiAIN	IT9
SD1103-0660-024-08R1 SD_DRILL_6.6MM_3XD	02899024	6,6 0.260	24,0 0.945	79,0 3.110	43,0 1.693	36,0 1.417	34,0 1.339	8,0 0.315	140°	TiAIN	IT9
SD1103-0675-024-08R1 SD_DRILL_17/64_3XD	02899025	6,747 0.266	24,0 0.945	79,0 3.110	43,0 1.693	36,0 1.417	34,0 1.339	8,0 0.315	140°	TiAIN	IT9
SD1103-0680-024-08R1 SD_DRILL_6.8MM_3XD	02899026	6,8 0.268	24,0 0.945	79,0 3.110	43,0 1.693	36,0 1.417	34,0 1.339	8,0 0.315	140°	TiAIN	IT9

Wstęp

Wiercenie

Rozwiercanie

Wyłaczanie

Załącznik

Oznaczenie	Numer produktu	DC	LU	OAL	LFS	LS	LCF	DMM	Kąt wierzchołkowy	Pokrycie	Tolerancja otworu
		mm Cal.	mm Cal.	mm Cal.	mm Cal.	mm Cal.	mm Cal.	mm Cal.			
SD1103-0690-024-08R1 SD_DRILL_6.9MM_3XD	02899027	6,9 0.272	24,0 0.945	79,0 3.110	43,0 1.693	36,0 1.417	34,0 1.339	8,0 0.315	140°	TiAIN	IT9
SD1103-0700-024-08R1 SD_DRILL_7.0MM_3XD	02899028	7,0 0.276	24,0 0.945	79,0 3.110	43,0 1.693	36,0 1.417	34,0 1.339	8,0 0.315	140°	TiAIN	IT9
SD1103-0710-029-08R1 SD_DRILL_7.1MM_3XD	02899029	7,1 0.280	29,0 1.142	79,0 3.110	43,0 1.693	36,0 1.417	41,0 1.614	8,0 0.315	140°	TiAIN	IT9
SD1103-0714-029-08R1 SD_DRILL_9/32_3XD	02899030	7,144 0.281	29,0 1.142	79,0 3.110	43,0 1.693	36,0 1.417	41,0 1.614	8,0 0.315	140°	TiAIN	IT9
SD1103-0720-029-08R1 SD_DRILL_7.2MM_3XD	02899031	7,2 0.283	29,0 1.142	79,0 3.110	43,0 1.693	36,0 1.417	41,0 1.614	8,0 0.315	140°	TiAIN	IT9
SD1103-0730-029-08R1 SD_DRILL_7.3MM_3XD	02899032	7,3 0.287	29,0 1.142	79,0 3.110	43,0 1.693	36,0 1.417	41,0 1.614	8,0 0.315	140°	TiAIN	IT9
SD1103-0740-029-08R1 SD_DRILL_7.4MM_3XD	02899033	7,4 0.291	29,0 1.142	79,0 3.110	43,0 1.693	36,0 1.417	41,0 1.614	8,0 0.315	140°	TiAIN	IT9
SD1103-0750-029-08R1 SD_DRILL_7.5MM_3XD	02899034	7,5 0.295	29,0 1.142	79,0 3.110	43,0 1.693	36,0 1.417	41,0 1.614	8,0 0.315	140°	TiAIN	IT9
SD1103-0754-029-08R1 SD_DRILL_19/64_3XD	02899035	7,541 0.297	29,0 1.142	79,0 3.110	43,0 1.693	36,0 1.417	41,0 1.614	8,0 0.315	140°	TiAIN	IT9
SD1103-0755-029-08R1 SD_DRILL_7.55MM_3XD	02899036	7,55 0.297	29,0 1.142	79,0 3.110	43,0 1.693	36,0 1.417	41,0 1.614	8,0 0.315	140°	TiAIN	IT9
SD1103-0760-029-08R1 SD_DRILL_7.6MM_3XD	02899037	7,6 0.299	29,0 1.142	79,0 3.110	43,0 1.693	36,0 1.417	41,0 1.614	8,0 0.315	140°	TiAIN	IT9
SD1103-0770-029-08R1 SD_DRILL_7.7MM_3XD	02899038	7,7 0.303	29,0 1.142	79,0 3.110	43,0 1.693	36,0 1.417	41,0 1.614	8,0 0.315	140°	TiAIN	IT9
SD1103-0780-029-08R1 SD_DRILL_7.8MM_3XD	02899040	7,8 0.307	29,0 1.142	79,0 3.110	43,0 1.693	36,0 1.417	41,0 1.614	8,0 0.315	140°	TiAIN	IT9
SD1103-0790-029-08R1 SD_DRILL_7.9MM_3XD	02899041	7,9 0.311	29,0 1.142	79,0 3.110	43,0 1.693	36,0 1.417	41,0 1.614	8,0 0.315	140°	TiAIN	IT9
SD1103-0794-029-08R1 SD_DRILL_5/16_3XD	02899042	7,938 0.313	29,0 1.142	79,0 3.110	43,0 1.693	36,0 1.417	41,0 1.614	8,0 0.315	140°	TiAIN	IT9
SD1103-0800-029-08R1 SD_DRILL_8.0MM_3XD	02899043	8,0 0.315	29,0 1.142	79,0 3.110	43,0 1.693	36,0 1.417	41,0 1.614	8,0 0.315	140°	TiAIN	IT9
SD1103-0810-035-10R1 SD_DRILL_8.1MM_3XD	02899044	8,1 0.319	35,0 1.378	89,0 3.504	49,0 1.929	40,0 1.575	47,0 1.850	10,0 0.394	140°	TiAIN	IT9
SD1103-0820-035-10R1 SD_DRILL_8.2MM_3XD	02899045	8,2 0.323	35,0 1.378	89,0 3.504	49,0 1.929	40,0 1.575	47,0 1.850	10,0 0.394	140°	TiAIN	IT9
SD1103-0830-035-10R1 SD_DRILL_8.3MM_3XD	02899046	8,3 0.327	35,0 1.378	89,0 3.504	49,0 1.929	40,0 1.575	47,0 1.850	10,0 0.394	140°	TiAIN	IT9
SD1103-0833-035-10R1 SD_DRILL_21/64_3XD	02899047	8,334 0.328	35,0 1.378	89,0 3.504	49,0 1.929	40,0 1.575	47,0 1.850	10,0 0.394	140°	TiAIN	IT9
SD1103-0840-035-10R1 SD_DRILL_8.4MM_3XD	02899048	8,4 0.331	35,0 1.378	89,0 3.504	49,0 1.929	40,0 1.575	47,0 1.850	10,0 0.394	140°	TiAIN	IT9
SD1103-0850-035-10R1 SD_DRILL_8.5MM_3XD	02899049	8,5 0.335	35,0 1.378	89,0 3.504	49,0 1.929	40,0 1.575	47,0 1.850	10,0 0.394	140°	TiAIN	IT9
SD1103-0860-035-10R1 SD_DRILL_8.6MM_3XD	02899050	8,6 0.339	35,0 1.378	89,0 3.504	49,0 1.929	40,0 1.575	47,0 1.850	10,0 0.394	140°	TiAIN	IT9
SD1103-0870-035-10R1 SD_DRILL_8.7MM_3XD	02899051	8,7 0.343	35,0 1.378	89,0 3.504	49,0 1.929	40,0 1.575	47,0 1.850	10,0 0.394	140°	TiAIN	IT9
SD1103-0873-035-10R1 SD_DRILL_11/32_3XD	02899052	8,731 0.344	35,0 1.378	89,0 3.504	49,0 1.929	40,0 1.575	47,0 1.850	10,0 0.394	140°	TiAIN	IT9
SD1103-0880-035-10R1 SD_DRILL_8.8MM_3XD	02899053	8,8 0.346	35,0 1.378	89,0 3.504	49,0 1.929	40,0 1.575	47,0 1.850	10,0 0.394	140°	TiAIN	IT9
SD1103-0890-035-10R1 SD_DRILL_8.9MM_3XD	02899054	8,9 0.350	35,0 1.378	89,0 3.504	49,0 1.929	40,0 1.575	47,0 1.850	10,0 0.394	140°	TiAIN	IT9
SD1103-0900-035-10R1 SD_DRILL_9.0MM_3XD	02899055	9,0 0.354	35,0 1.378	89,0 3.504	49,0 1.929	40,0 1.575	47,0 1.850	10,0 0.394	140°	TiAIN	IT9
SD1103-0910-035-10R1 SD_DRILL_9.1MM_3XD	02899056	9,1 0.358	35,0 1.378	89,0 3.504	49,0 1.929	40,0 1.575	47,0 1.850	10,0 0.394	140°	TiAIN	IT9
SD1103-0913-035-10R1 SD_DRILL_23/64_3XD	02899058	9,128 0.359	35,0 1.378	89,0 3.504	49,0 1.929	40,0 1.575	47,0 1.850	10,0 0.394	140°	TiAIN	IT9
SD1103-0920-035-10R1 SD_DRILL_9.2MM_3XD	02899059	9,2 0.362	35,0 1.378	89,0 3.504	49,0 1.929	40,0 1.575	47,0 1.850	10,0 0.394	140°	TiAIN	IT9

Wstęp

Wiercenie

Rozwiercanie

Wytaczanie

Załącznik

Oznaczenie	Numer produktu	DC	LU	OAL	LFS	LS	LCF	DMM	Kąt wierzchołkowy	Pokrycie	Tolerancja otworu
		mm Cal.	mm Cal.	mm Cal.	mm Cal.	mm Cal.	mm Cal.	mm Cal.			
SD1103-0930-035-10R1 SD_DRILL_9.3MM_3XD	02899060	9,3 0.366	35,0 1.378	89,0 3.504	49,0 1.929	40,0 1.575	47,0 1.850	10,0 0.394	140°	TiAIN	IT9
SD1103-0940-035-10R1 SD_DRILL_9.4MM_3XD	02899061	9,4 0.370	35,0 1.378	89,0 3.504	49,0 1.929	40,0 1.575	47,0 1.850	10,0 0.394	140°	TiAIN	IT9
SD1103-0950-035-10R1 SD_DRILL_9.5MM_3XD	02899062	9,5 0.374	35,0 1.378	89,0 3.504	49,0 1.929	40,0 1.575	47,0 1.850	10,0 0.394	140°	TiAIN	IT9
SD1103-0953-035-10R1 SD_DRILL_3/8_3XD	02899063	9,525 0.375	35,0 1.378	89,0 3.504	49,0 1.929	40,0 1.575	47,0 1.850	10,0 0.394	140°	TiAIN	IT9
SD1103-0955-035-10R1 SD_DRILL_9.55MM_3XD	02899064	9,55 0.376	35,0 1.378	89,0 3.504	49,0 1.929	40,0 1.575	47,0 1.850	10,0 0.394	140°	TiAIN	IT9
SD1103-0960-035-10R1 SD_DRILL_9.6MM_3XD	02899065	9,6 0.378	35,0 1.378	89,0 3.504	49,0 1.929	40,0 1.575	47,0 1.850	10,0 0.394	140°	TiAIN	IT9
SD1103-0970-035-10R1 SD_DRILL_9.7MM_3XD	02899066	9,7 0.382	35,0 1.378	89,0 3.504	49,0 1.929	40,0 1.575	47,0 1.850	10,0 0.394	140°	TiAIN	IT9
SD1103-0980-035-10R1 SD_DRILL_9.8MM_3XD	02899067	9,8 0.386	35,0 1.378	89,0 3.504	49,0 1.929	40,0 1.575	47,0 1.850	10,0 0.394	140°	TiAIN	IT9
SD1103-0990-035-10R1 SD_DRILL_9.9MM_3XD	02899068	9,9 0.390	35,0 1.378	89,0 3.504	49,0 1.929	40,0 1.575	47,0 1.850	10,0 0.394	140°	TiAIN	IT9
SD1103-0992-035-10R1 SD_DRILL_25/64_3XD	02899069	9,922 0.391	35,0 1.378	89,0 3.504	49,0 1.929	40,0 1.575	47,0 1.850	10,0 0.394	140°	TiAIN	IT9
SD1103-1000-035-10R1 SD_DRILL_10.0MM_3XD	02899070	10,0 0.394	35,0 1.378	89,0 3.504	49,0 1.929	40,0 1.575	47,0 1.850	10,0 0.394	140°	TiAIN	IT9
SD1103-1020-040-12R1 SD_DRILL_10.2MM_3XD	02899071	10,2 0.402	40,0 1.575	102,0 4.016	57,0 2.244	45,0 1.772	55,0 2.165	12,0 0.472	140°	TiAIN	IT9
SD1103-1032-040-12R1 SD_DRILL_13/32_3XD	02899072	10,319 0.406	40,0 1.575	102,0 4.016	57,0 2.244	45,0 1.772	55,0 2.165	12,0 0.472	140°	TiAIN	IT9
SD1103-1040-040-12R1 SD_DRILL_10.4MM_3XD	02899073	10,4 0.409	40,0 1.575	102,0 4.016	57,0 2.244	45,0 1.772	55,0 2.165	12,0 0.472	140°	TiAIN	IT9
SD1103-1050-040-12R1 SD_DRILL_10.5MM_3XD	02899074	10,5 0.413	40,0 1.575	102,0 4.016	57,0 2.244	45,0 1.772	55,0 2.165	12,0 0.472	140°	TiAIN	IT9
SD1103-1060-040-12R1 SD_DRILL_10.6MM_3XD	02899075	10,6 0.417	40,0 1.575	102,0 4.016	57,0 2.244	45,0 1.772	55,0 2.165	12,0 0.472	140°	TiAIN	IT9
SD1103-1072-040-12R1 SD_DRILL_27/64_3XD	02899076	10,716 0.422	40,0 1.575	102,0 4.016	57,0 2.244	45,0 1.772	55,0 2.165	12,0 0.472	140°	TiAIN	IT9
SD1103-1080-040-12R1 SD_DRILL_10.8MM_3XD	02899077	10,8 0.425	40,0 1.575	102,0 4.016	57,0 2.244	45,0 1.772	55,0 2.165	12,0 0.472	140°	TiAIN	IT9
SD1103-1090-040-12R1 SD_DRILL_10.9MM_3XD	02899078	10,9 0.429	40,0 1.575	102,0 4.016	57,0 2.244	45,0 1.772	55,0 2.165	12,0 0.472	140°	TiAIN	IT9
SD1103-1100-040-12R1 SD_DRILL_11.0MM_3XD	02899079	11,0 0.433	40,0 1.575	102,0 4.016	57,0 2.244	45,0 1.772	55,0 2.165	12,0 0.472	140°	TiAIN	IT9
SD1103-1110-040-12R1 SD_DRILL_11.1MM_3XD	02899080	11,1 0.437	40,0 1.575	102,0 4.016	57,0 2.244	45,0 1.772	55,0 2.165	12,0 0.472	140°	TiAIN	IT9
SD1103-1111-040-12R1 SD_DRILL_7/16_3XD	02899081	11,113 0.438	40,0 1.575	102,0 4.016	57,0 2.244	45,0 1.772	55,0 2.165	12,0 0.472	140°	TiAIN	IT9
SD1103-1120-040-12R1 SD_DRILL_11.2MM_3XD	02899082	11,2 0.441	40,0 1.575	102,0 4.016	57,0 2.244	45,0 1.772	55,0 2.165	12,0 0.472	140°	TiAIN	IT9
SD1103-1130-040-12R1 SD_DRILL_11.3MM_3XD	02899083	11,3 0.445	40,0 1.575	102,0 4.016	57,0 2.244	45,0 1.772	55,0 2.165	12,0 0.472	140°	TiAIN	IT9
SD1103-1140-040-12R1 SD_DRILL_11.4MM_3XD	02899084	11,4 0.449	40,0 1.575	102,0 4.016	57,0 2.244	45,0 1.772	55,0 2.165	12,0 0.472	140°	TiAIN	IT9
SD1103-1150-040-12R1 SD_DRILL_11.5MM_3XD	02899085	11,5 0.453	40,0 1.575	102,0 4.016	57,0 2.244	45,0 1.772	55,0 2.165	12,0 0.472	140°	TiAIN	IT9
SD1103-1151-040-12R1 SD_DRILL_29/64_3XD	02899086	11,509 0.453	40,0 1.575	102,0 4.016	57,0 2.244	45,0 1.772	55,0 2.165	12,0 0.472	140°	TiAIN	IT9
SD1103-1155-040-12R1 SD_DRILL_11.55MM_3XD	02899087	11,55 0.455	40,0 1.575	102,0 4.016	57,0 2.244	45,0 1.772	55,0 2.165	12,0 0.472	140°	TiAIN	IT9
SD1103-1160-040-12R1 SD_DRILL_11.6MM_3XD	02899088	11,6 0.457	40,0 1.575	102,0 4.016	57,0 2.244	45,0 1.772	55,0 2.165	12,0 0.472	140°	TiAIN	IT9
SD1103-1170-040-12R1 SD_DRILL_11.7MM_3XD	02899089	11,7 0.461	40,0 1.575	102,0 4.016	57,0 2.244	45,0 1.772	55,0 2.165	12,0 0.472	140°	TiAIN	IT9
SD1103-1180-040-12R1 SD_DRILL_11.8MM_3XD	02899090	11,8 0.465	40,0 1.575	102,0 4.016	57,0 2.244	45,0 1.772	55,0 2.165	12,0 0.472	140°	TiAIN	IT9

Wstęp

Wiercenie

Rozwiercanie

Wylaczanie

Zalacznik

Oznaczenie	Numer produktu	DC	LU	OAL	LFS	LS	LCF	DMM	Kąt wierzchołkowy	Pokrycie	Tolerancja otworu
		mm <i>Cal.</i>	mm <i>Cal.</i>	mm <i>Cal.</i>	mm <i>Cal.</i>	mm <i>Cal.</i>	mm <i>Cal.</i>	mm <i>Cal.</i>			
SD1103-1190-040-12R1 <i>SD_DRILL_11.9MM_3XD</i>	02899091	11,9 <i>0.469</i>	40,0 <i>1.575</i>	102,0 <i>4.016</i>	57,0 <i>2.244</i>	45,0 <i>1.772</i>	55,0 <i>2.165</i>	12,0 <i>0.472</i>	140°	TiAIN	IT9
SD1103-1191-040-12R1 <i>SD_DRILL_15/32_3XD</i>	02899092	11,906 <i>0.469</i>	40,0 <i>1.575</i>	102,0 <i>4.016</i>	57,0 <i>2.244</i>	45,0 <i>1.772</i>	55,0 <i>2.165</i>	12,0 <i>0.472</i>	140°	TiAIN	IT9
SD1103-1200-040-12R1 <i>SD_DRILL_12.0MM_3XD</i>	02899093	12,0 <i>0.472</i>	40,0 <i>1.575</i>	102,0 <i>4.016</i>	57,0 <i>2.244</i>	45,0 <i>1.772</i>	55,0 <i>2.165</i>	12,0 <i>0.472</i>	140°	TiAIN	IT9
SD1103-1210-043-14R1 <i>SD_DRILL_12.1MM_3XD</i>	02899094	12,1 <i>0.476</i>	43,0 <i>1.693</i>	107,0 <i>4.213</i>	62,0 <i>2.441</i>	45,0 <i>1.772</i>	60,0 <i>2.362</i>	14,0 <i>0.551</i>	140°	TiAIN	IT9
SD1103-1220-043-14R1 <i>SD_DRILL_12.2MM_3XD</i>	02899095	12,2 <i>0.480</i>	43,0 <i>1.693</i>	107,0 <i>4.213</i>	62,0 <i>2.441</i>	45,0 <i>1.772</i>	60,0 <i>2.362</i>	14,0 <i>0.551</i>	140°	TiAIN	IT9
SD1103-1230-043-14R1 <i>SD_DRILL_31/64_3XD</i>	02899096	12,303 <i>0.484</i>	43,0 <i>1.693</i>	107,0 <i>4.213</i>	62,0 <i>2.441</i>	45,0 <i>1.772</i>	60,0 <i>2.362</i>	14,0 <i>0.551</i>	140°	TiAIN	IT9
SD1103-1240-043-14R1 <i>SD_DRILL_12.4MM_3XD</i>	02899097	12,4 <i>0.488</i>	43,0 <i>1.693</i>	107,0 <i>4.213</i>	62,0 <i>2.441</i>	45,0 <i>1.772</i>	60,0 <i>2.362</i>	14,0 <i>0.551</i>	140°	TiAIN	IT9
SD1103-1250-043-14R1 <i>SD_DRILL_12.5MM_3XD</i>	02899098	12,5 <i>0.492</i>	43,0 <i>1.693</i>	107,0 <i>4.213</i>	62,0 <i>2.441</i>	45,0 <i>1.772</i>	60,0 <i>2.362</i>	14,0 <i>0.551</i>	140°	TiAIN	IT9
SD1103-1260-043-14R1 <i>SD_DRILL_12.6MM_3XD</i>	02899099	12,6 <i>0.496</i>	43,0 <i>1.693</i>	107,0 <i>4.213</i>	62,0 <i>2.441</i>	45,0 <i>1.772</i>	60,0 <i>2.362</i>	14,0 <i>0.551</i>	140°	TiAIN	IT9
SD1103-1270-043-14R1 <i>SD_DRILL_1/2_3XD</i>	02899100	12,7 <i>0.500</i>	43,0 <i>1.693</i>	107,0 <i>4.213</i>	62,0 <i>2.441</i>	45,0 <i>1.772</i>	60,0 <i>2.362</i>	14,0 <i>0.551</i>	140°	TiAIN	IT9
SD1103-1275-043-14R1 <i>SD_DRILL_12.75MM_3XD</i>	02899101	12,75 <i>0.502</i>	43,0 <i>1.693</i>	107,0 <i>4.213</i>	62,0 <i>2.441</i>	45,0 <i>1.772</i>	60,0 <i>2.362</i>	14,0 <i>0.551</i>	140°	TiAIN	IT9
SD1103-1280-043-14R1 <i>SD_DRILL_12.8MM_3XD</i>	02899102	12,8 <i>0.504</i>	43,0 <i>1.693</i>	107,0 <i>4.213</i>	62,0 <i>2.441</i>	45,0 <i>1.772</i>	60,0 <i>2.362</i>	14,0 <i>0.551</i>	140°	TiAIN	IT9
SD1103-1290-043-14R1 <i>SD_DRILL_12.9MM_3XD</i>	02899103	12,9 <i>0.508</i>	43,0 <i>1.693</i>	107,0 <i>4.213</i>	62,0 <i>2.441</i>	45,0 <i>1.772</i>	60,0 <i>2.362</i>	14,0 <i>0.551</i>	140°	TiAIN	IT9
SD1103-1300-043-14R1 <i>SD_DRILL_13.0MM_3XD</i>	02899104	13,0 <i>0.512</i>	43,0 <i>1.693</i>	107,0 <i>4.213</i>	62,0 <i>2.441</i>	45,0 <i>1.772</i>	60,0 <i>2.362</i>	14,0 <i>0.551</i>	140°	TiAIN	IT9
SD1103-1310-043-14R1 <i>SD_DRILL_33/64_3XD</i>	02899105	13,1 <i>0.516</i>	43,0 <i>1.693</i>	107,0 <i>4.213</i>	62,0 <i>2.441</i>	45,0 <i>1.772</i>	60,0 <i>2.362</i>	14,0 <i>0.551</i>	140°	TiAIN	IT9
SD1103-1320-043-14R1 <i>SD_DRILL_13.2MM_3XD</i>	02899106	13,2 <i>0.520</i>	43,0 <i>1.693</i>	107,0 <i>4.213</i>	62,0 <i>2.441</i>	45,0 <i>1.772</i>	60,0 <i>2.362</i>	14,0 <i>0.551</i>	140°	TiAIN	IT9
SD1103-1330-043-14R1 <i>SD_DRILL_13.3MM_3XD</i>	02899107	13,3 <i>0.524</i>	43,0 <i>1.693</i>	107,0 <i>4.213</i>	62,0 <i>2.441</i>	45,0 <i>1.772</i>	60,0 <i>2.362</i>	14,0 <i>0.551</i>	140°	TiAIN	IT9
SD1103-1340-043-14R1 <i>SD_DRILL_13.4MM_3XD</i>	02899108	13,4 <i>0.528</i>	43,0 <i>1.693</i>	107,0 <i>4.213</i>	62,0 <i>2.441</i>	45,0 <i>1.772</i>	60,0 <i>2.362</i>	14,0 <i>0.551</i>	140°	TiAIN	IT9
SD1103-1349-043-14R1 <i>SD_DRILL_17/32_3XD</i>	02899109	13,494 <i>0.531</i>	43,0 <i>1.693</i>	107,0 <i>4.213</i>	62,0 <i>2.441</i>	45,0 <i>1.772</i>	60,0 <i>2.362</i>	14,0 <i>0.551</i>	140°	TiAIN	IT9
SD1103-1350-043-14R1 <i>SD_DRILL_13.5MM_3XD</i>	02899110	13,5 <i>0.531</i>	43,0 <i>1.693</i>	107,0 <i>4.213</i>	62,0 <i>2.441</i>	45,0 <i>1.772</i>	60,0 <i>2.362</i>	14,0 <i>0.551</i>	140°	TiAIN	IT9
SD1103-1360-043-14R1 <i>SD_DRILL_13.6MM_3XD</i>	02899111	13,6 <i>0.535</i>	43,0 <i>1.693</i>	107,0 <i>4.213</i>	62,0 <i>2.441</i>	45,0 <i>1.772</i>	60,0 <i>2.362</i>	14,0 <i>0.551</i>	140°	TiAIN	IT9
SD1103-1370-043-14R1 <i>SD_DRILL_13.7MM_3XD</i>	02899112	13,7 <i>0.539</i>	43,0 <i>1.693</i>	107,0 <i>4.213</i>	62,0 <i>2.441</i>	45,0 <i>1.772</i>	60,0 <i>2.362</i>	14,0 <i>0.551</i>	140°	TiAIN	IT9
SD1103-1380-043-14R1 <i>SD_DRILL_13.8MM_3XD</i>	02899113	13,8 <i>0.543</i>	43,0 <i>1.693</i>	107,0 <i>4.213</i>	62,0 <i>2.441</i>	45,0 <i>1.772</i>	60,0 <i>2.362</i>	14,0 <i>0.551</i>	140°	TiAIN	IT9
SD1103-1390-043-14R1 <i>SD_DRILL_35/64_3XD</i>	02899114	13,9 <i>0.547</i>	43,0 <i>1.693</i>	107,0 <i>4.213</i>	62,0 <i>2.441</i>	45,0 <i>1.772</i>	60,0 <i>2.362</i>	14,0 <i>0.551</i>	140°	TiAIN	IT9
SD1103-1400-043-14R1 <i>SD_DRILL_14.0MM_3XD</i>	02899115	14,0 <i>0.551</i>	43,0 <i>1.693</i>	107,0 <i>4.213</i>	62,0 <i>2.441</i>	45,0 <i>1.772</i>	60,0 <i>2.362</i>	14,0 <i>0.551</i>	140°	TiAIN	IT9
SD1103-1420-045-16R1 <i>SD_DRILL_14.2MM_3XD</i>	02899116	14,2 <i>0.559</i>	45,0 <i>1.772</i>	115,0 <i>4.528</i>	67,0 <i>2.638</i>	48,0 <i>1.890</i>	65,0 <i>2.559</i>	16,0 <i>0.630</i>	140°	TiAIN	IT9
SD1103-1429-045-16R1 <i>SD_DRILL_9/16_3XD</i>	02899117	14,288 <i>0.563</i>	45,0 <i>1.772</i>	115,0 <i>4.528</i>	67,0 <i>2.638</i>	48,0 <i>1.890</i>	65,0 <i>2.559</i>	16,0 <i>0.630</i>	140°	TiAIN	IT9
SD1103-1450-045-16R1 <i>SD_DRILL_14.5MM_3XD</i>	02899119	14,5 <i>0.571</i>	45,0 <i>1.772</i>	115,0 <i>4.528</i>	67,0 <i>2.638</i>	48,0 <i>1.890</i>	65,0 <i>2.559</i>	16,0 <i>0.630</i>	140°	TiAIN	IT9
SD1103-1470-045-16R1 <i>SD_DRILL_14.7MM_3XD</i>	02899120	14,7 <i>0.579</i>	45,0 <i>1.772</i>	115,0 <i>4.528</i>	67,0 <i>2.638</i>	48,0 <i>1.890</i>	65,0 <i>2.559</i>	16,0 <i>0.630</i>	140°	TiAIN	IT9
SD1103-1475-045-16R1 <i>SD_DRILL_14.75MM_3XD</i>	02899121	14,75 <i>0.581</i>	45,0 <i>1.772</i>	115,0 <i>4.528</i>	67,0 <i>2.638</i>	48,0 <i>1.890</i>	65,0 <i>2.559</i>	16,0 <i>0.630</i>	140°	TiAIN	IT9
SD1103-1480-045-16R1 <i>SD_DRILL_14.8MM_3XD</i>	02899122	14,8 <i>0.583</i>	45,0 <i>1.772</i>	115,0 <i>4.528</i>	67,0 <i>2.638</i>	48,0 <i>1.890</i>	65,0 <i>2.559</i>	16,0 <i>0.630</i>	140°	TiAIN	IT9

Wstęp

Wiercenie

Rozwiercanie

Wytaczanie

Załącznik

Oznaczenie	Numer produktu	DC	LU	OAL	LFS	LS	LCF	DMM	Kąt wierzchołkowy	Pokrycie	Tolerancja otworu
		mm <i>Cal.</i>	mm <i>Cal.</i>	mm <i>Cal.</i>	mm <i>Cal.</i>	mm <i>Cal.</i>	mm <i>Cal.</i>	mm <i>Cal.</i>			
SD1103-1500-045-16R1 <i>SD_DRILL_15.0MM_3XD</i>	02899123	15,0 <i>0.591</i>	45,0 <i>1.772</i>	115,0 <i>4.528</i>	67,0 <i>2.638</i>	48,0 <i>1.890</i>	65,0 <i>2.559</i>	16,0 <i>0.630</i>	140°	TiAIN	IT9
SD1103-1510-045-16R1 <i>SD_DRILL_15.1MM_3XD</i>	02899124	15,1 <i>0.594</i>	45,0 <i>1.772</i>	115,0 <i>4.528</i>	67,0 <i>2.638</i>	48,0 <i>1.890</i>	65,0 <i>2.559</i>	16,0 <i>0.630</i>	140°	TiAIN	IT9
SD1103-1530-045-16R1 <i>SD_DRILL_15.3MM_3XD</i>	02899125	15,3 <i>0.602</i>	45,0 <i>1.772</i>	115,0 <i>4.528</i>	67,0 <i>2.638</i>	48,0 <i>1.890</i>	65,0 <i>2.559</i>	16,0 <i>0.630</i>	140°	TiAIN	IT9
SD1103-1550-045-16R1 <i>SD_DRILL_15.5MM_3XD</i>	02899126	15,5 <i>0.610</i>	45,0 <i>1.772</i>	115,0 <i>4.528</i>	67,0 <i>2.638</i>	48,0 <i>1.890</i>	65,0 <i>2.559</i>	16,0 <i>0.630</i>	140°	TiAIN	IT9
SD1103-1570-045-16R1 <i>SD_DRILL_15.7MM_3XD</i>	02899127	15,7 <i>0.618</i>	45,0 <i>1.772</i>	115,0 <i>4.528</i>	67,0 <i>2.638</i>	48,0 <i>1.890</i>	65,0 <i>2.559</i>	16,0 <i>0.630</i>	140°	TiAIN	IT9
SD1103-1580-045-16R1 <i>SD_DRILL_15.8MM_3XD</i>	02899128	15,8 <i>0.622</i>	45,0 <i>1.772</i>	115,0 <i>4.528</i>	67,0 <i>2.638</i>	48,0 <i>1.890</i>	65,0 <i>2.559</i>	16,0 <i>0.630</i>	140°	TiAIN	IT9
SD1103-1588-045-16R1 <i>SD_DRILL_5/8_3XD</i>	02899129	15,875 <i>0.625</i>	45,0 <i>1.772</i>	115,0 <i>4.528</i>	67,0 <i>2.638</i>	48,0 <i>1.890</i>	65,0 <i>2.559</i>	16,0 <i>0.630</i>	140°	TiAIN	IT9
SD1103-1600-045-16R1 <i>SD_DRILL_16.0MM_3XD</i>	02899130	16,0 <i>0.630</i>	45,0 <i>1.772</i>	115,0 <i>4.528</i>	67,0 <i>2.638</i>	48,0 <i>1.890</i>	65,0 <i>2.559</i>	16,0 <i>0.630</i>	140°	TiAIN	IT9
SD1103-1650-051-18R1 <i>SD_DRILL_16.5MM_3XD</i>	02899131	16,5 <i>0.650</i>	51,0 <i>2.008</i>	123,0 <i>4.843</i>	75,0 <i>2.953</i>	48,0 <i>1.890</i>	73,0 <i>2.874</i>	18,0 <i>0.709</i>	140°	TiAIN	IT9
SD1103-1700-051-18R1 <i>SD_DRILL_17.0MM_3XD</i>	02899132	17,0 <i>0.669</i>	51,0 <i>2.008</i>	123,0 <i>4.843</i>	75,0 <i>2.953</i>	48,0 <i>1.890</i>	73,0 <i>2.874</i>	18,0 <i>0.709</i>	140°	TiAIN	IT9
SD1103-1750-051-18R1 <i>SD_DRILL_17.5MM_3XD</i>	02899133	17,5 <i>0.689</i>	51,0 <i>2.008</i>	123,0 <i>4.843</i>	75,0 <i>2.953</i>	48,0 <i>1.890</i>	73,0 <i>2.874</i>	18,0 <i>0.709</i>	140°	TiAIN	IT9
SD1103-1800-051-18R1 <i>SD_DRILL_18.0MM_3XD</i>	02899134	18,0 <i>0.709</i>	51,0 <i>2.008</i>	123,0 <i>4.843</i>	75,0 <i>2.953</i>	48,0 <i>1.890</i>	73,0 <i>2.874</i>	18,0 <i>0.709</i>	140°	TiAIN	IT9
SD1103-1850-055-20R1 <i>SD_DRILL_18.5MM_3XD</i>	02899135	18,5 <i>0.728</i>	55,0 <i>2.165</i>	131,0 <i>5.157</i>	81,0 <i>3.189</i>	50,0 <i>1.969</i>	79,0 <i>3.110</i>	20,0 <i>0.787</i>	140°	TiAIN	IT9
SD1103-1900-055-20R1 <i>SD_DRILL_19.0MM_3XD</i>	02899136	19,0 <i>0.748</i>	55,0 <i>2.165</i>	131,0 <i>5.157</i>	81,0 <i>3.189</i>	50,0 <i>1.969</i>	79,0 <i>3.110</i>	20,0 <i>0.787</i>	140°	TiAIN	IT9
SD1103-1905-055-20R1 <i>SD_DRILL_3/4_3XD</i>	02899137	19,05 <i>0.750</i>	55,0 <i>2.165</i>	131,0 <i>5.157</i>	81,0 <i>3.189</i>	50,0 <i>1.969</i>	79,0 <i>3.110</i>	20,0 <i>0.787</i>	140°	TiAIN	IT9
SD1103-1950-055-20R1 <i>SD_DRILL_19.5MM_3XD</i>	02899138	19,5 <i>0.768</i>	55,0 <i>2.165</i>	131,0 <i>5.157</i>	81,0 <i>3.189</i>	50,0 <i>1.969</i>	79,0 <i>3.110</i>	20,0 <i>0.787</i>	140°	TiAIN	IT9
SD1103-2000-055-20R1 <i>SD_DRILL_20.0MM_3XD</i>	02899139	20,0 <i>0.787</i>	55,0 <i>2.165</i>	131,0 <i>5.157</i>	81,0 <i>3.189</i>	50,0 <i>1.969</i>	79,0 <i>3.110</i>	20,0 <i>0.787</i>	140°	TiAIN	IT9

SD1103A

Głębokość wiercenia ~ 3 x D – Metryczne/Calowe

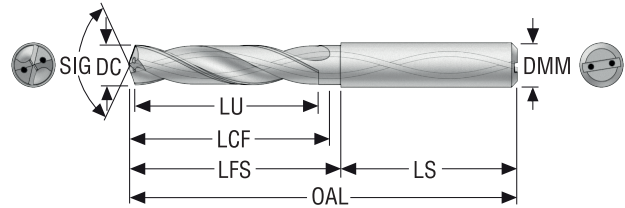
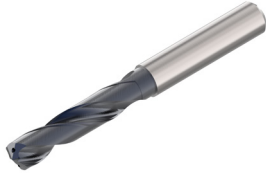

- Chwyt cylindryczny DIN 6537A
- Tolerancja DC m7
- Chłodzenie wewnętrzne
- Parametry skrawania, patrz strona (strony) 140
- Średnice pośrednie patrz aplikacja MyDesign.

Oznaczenie	Numer produktu	DC	LU	OAL	LFS	LS	LCF	DMM	Kąt wierzchołkowy	Pokrycie	Tolerancja otworu
		mm Cal.	mm Cal.	mm Cal.	mm Cal.	mm Cal.	mm Cal.	mm Cal.			
SD1103A-0300-014-06R1 SD_DRILL_3.0MM_3XD_A	02898244	3,0 0.118	14,0 0.551	62,0 2.441	26,0 1.024	36,0 1.417	20,0 0.787	6,0 0.236	140°	TiAlN	IT9
SD1103A-0310-014-06R1 SD_DRILL_3.1MM_3XD_A	02898245	3,1 0.122	14,0 0.551	62,0 2.441	26,0 1.024	36,0 1.417	20,0 0.787	6,0 0.236	140°	TiAlN	IT9
SD1103A-0318-014-06R1 SD_DRILL_1/8_3XD_A	02898246	3,175 0.125	14,0 0.551	62,0 2.441	26,0 1.024	36,0 1.417	20,0 0.787	6,0 0.236	140°	TiAlN	IT9
SD1103A-0320-014-06R1 SD_DRILL_3.2MM_3XD_A	02898247	3,2 0.126	14,0 0.551	62,0 2.441	26,0 1.024	36,0 1.417	20,0 0.787	6,0 0.236	140°	TiAlN	IT9
SD1103A-0325-014-06R1 SD_DRILL_3.25MM_3XD_A	02898248	3,25 0.128	14,0 0.551	62,0 2.441	26,0 1.024	36,0 1.417	20,0 0.787	6,0 0.236	140°	TiAlN	IT9
SD1103A-0330-014-06R1 SD_DRILL_3.3MM_3XD_A	02898249	3,3 0.130	14,0 0.551	62,0 2.441	26,0 1.024	36,0 1.417	20,0 0.787	6,0 0.236	140°	TiAlN	IT9
SD1103A-0340-014-06R1 SD_DRILL_3.4MM_3XD_A	02898250	3,4 0.134	14,0 0.551	62,0 2.441	26,0 1.024	36,0 1.417	20,0 0.787	6,0 0.236	140°	TiAlN	IT9
SD1103A-0350-014-06R1 SD_DRILL_3.5MM_3XD_A	02898251	3,5 0.138	14,0 0.551	62,0 2.441	26,0 1.024	36,0 1.417	20,0 0.787	6,0 0.236	140°	TiAlN	IT9
SD1103A-0357-014-06R1 SD_DRILL_9/64_3XD_A	02898252	3,572 0.141	14,0 0.551	62,0 2.441	26,0 1.024	36,0 1.417	20,0 0.787	6,0 0.236	140°	TiAlN	IT9
SD1103A-0360-014-06R1 SD_DRILL_3.6MM_3XD_A	02898253	3,6 0.142	14,0 0.551	62,0 2.441	26,0 1.024	36,0 1.417	20,0 0.787	6,0 0.236	140°	TiAlN	IT9
SD1103A-0365-014-06R1 SD_DRILL_3.65MM_3XD_A	02898254	3,65 0.144	14,0 0.551	62,0 2.441	26,0 1.024	36,0 1.417	20,0 0.787	6,0 0.236	140°	TiAlN	IT9
SD1103A-0370-014-06R1 SD_DRILL_3.7MM_3XD_A	02898255	3,7 0.146	14,0 0.551	62,0 2.441	26,0 1.024	36,0 1.417	20,0 0.787	6,0 0.236	140°	TiAlN	IT9
SD1103A-0380-017-06R1 SD_DRILL_3.8MM_3XD_A	02898256	3,8 0.150	17,0 0.669	66,0 2.598	30,0 1.181	36,0 1.417	24,0 0.945	6,0 0.236	140°	TiAlN	IT9
SD1103A-0390-017-06R1 SD_DRILL_3.9MM_3XD_A	02898257	3,9 0.154	17,0 0.669	66,0 2.598	30,0 1.181	36,0 1.417	24,0 0.945	6,0 0.236	140°	TiAlN	IT9
SD1103A-0397-017-06R1 SD_DRILL_5/32_3XD_A	02898258	3,969 0.156	17,0 0.669	66,0 2.598	30,0 1.181	36,0 1.417	24,0 0.945	6,0 0.236	140°	TiAlN	IT9
SD1103A-0400-017-06R1 SD_DRILL_4.0MM_3XD_A	02898259	4,0 0.157	17,0 0.669	66,0 2.598	30,0 1.181	36,0 1.417	24,0 0.945	6,0 0.236	140°	TiAlN	IT9
SD1103A-0410-017-06R1 SD_DRILL_4.1MM_3XD_A	02898260	4,1 0.161	17,0 0.669	66,0 2.598	30,0 1.181	36,0 1.417	24,0 0.945	6,0 0.236	140°	TiAlN	IT9
SD1103A-0420-017-06R1 SD_DRILL_4.2MM_3XD_A	02898261	4,2 0.165	17,0 0.669	66,0 2.598	30,0 1.181	36,0 1.417	24,0 0.945	6,0 0.236	140°	TiAlN	IT9
SD1103A-0430-017-06R1 SD_DRILL_4.3MM_3XD_A	02898262	4,3 0.169	17,0 0.669	66,0 2.598	30,0 1.181	36,0 1.417	24,0 0.945	6,0 0.236	140°	TiAlN	IT9
SD1103A-0437-017-06R1 SD_DRILL_11/64_3XD_A	02898263	4,366 0.172	17,0 0.669	66,0 2.598	30,0 1.181	36,0 1.417	24,0 0.945	6,0 0.236	140°	TiAlN	IT9
SD1103A-0450-017-06R1 SD_DRILL_4.5MM_3XD_A	02898264	4,5 0.177	17,0 0.669	66,0 2.598	30,0 1.181	36,0 1.417	24,0 0.945	6,0 0.236	140°	TiAlN	IT9

Wstęp

Wiercenie

Rozwiercanie

Wytyczanie

Załącznik

Oznaczenie	Numer produktu	DC	LU	OAL	LFS	LS	LCF	DMM	Kąt wierzchołkowy	Pokrycie	Tolerancja otworu
		mm Cal.	mm Cal.	mm Cal.	mm Cal.	mm Cal.	mm Cal.	mm Cal.	mm Cal.		
SD1103A-0460-017-06R1 SD_DRILL_4.6MM_3XD_A	02898265	4,6 0.181	17,0 0.669	66,0 2.598	30,0 1.181	36,0 1.417	24,0 0.945	6,0 0.236	140°	TiAIN	IT9
SD1103A-0465-017-06R1 SD_DRILL_4.65MM_3XD_A	02898266	4,65 0.183	17,0 0.669	66,0 2.598	30,0 1.181	36,0 1.417	24,0 0.945	6,0 0.236	140°	TiAIN	IT9
SD1103A-0470-017-06R1 SD_DRILL_4.7MM_3XD_A	02898267	4,7 0.185	17,0 0.669	66,0 2.598	30,0 1.181	36,0 1.417	24,0 0.945	6,0 0.236	140°	TiAIN	IT9
SD1103A-0476-020-06R1 SD_DRILL_3/16_3XD_A	02898268	4,763 0.188	20,0 0.787	66,0 2.598	30,0 1.181	36,0 1.417	28,0 1.102	6,0 0.236	140°	TiAIN	IT9
SD1103A-0480-020-06R1 SD_DRILL_4.8MM_3XD_A	02898269	4,8 0.189	20,0 0.787	66,0 2.598	30,0 1.181	36,0 1.417	28,0 1.102	6,0 0.236	140°	TiAIN	IT9
SD1103A-0490-020-06R1 SD_DRILL_4.9MM_3XD_A	02898270	4,9 0.193	20,0 0.787	66,0 2.598	30,0 1.181	36,0 1.417	28,0 1.102	6,0 0.236	140°	TiAIN	IT9
SD1103A-0500-020-06R1 SD_DRILL_5.0MM_3XD_A	02898271	5,0 0.197	20,0 0.787	66,0 2.598	30,0 1.181	36,0 1.417	28,0 1.102	6,0 0.236	140°	TiAIN	IT9
SD1103A-0510-020-06R1 SD_DRILL_5.1MM_3XD_A	02898272	5,1 0.201	20,0 0.787	66,0 2.598	30,0 1.181	36,0 1.417	28,0 1.102	6,0 0.236	140°	TiAIN	IT9
SD1103A-0516-020-06R1 SD_DRILL_13/64_3XD_A	02898273	5,159 0.203	20,0 0.787	66,0 2.598	30,0 1.181	36,0 1.417	28,0 1.102	6,0 0.236	140°	TiAIN	IT9
SD1103A-0520-020-06R1 SD_DRILL_5.2MM_3XD_A	02898275	5,2 0.205	20,0 0.787	66,0 2.598	30,0 1.181	36,0 1.417	28,0 1.102	6,0 0.236	140°	TiAIN	IT9
SD1103A-0530-020-06R1 SD_DRILL_5.3MM_3XD_A	02898276	5,3 0.209	20,0 0.787	66,0 2.598	30,0 1.181	36,0 1.417	28,0 1.102	6,0 0.236	140°	TiAIN	IT9
SD1103A-0540-020-06R1 SD_DRILL_5.4MM_3XD_A	02898277	5,4 0.213	20,0 0.787	66,0 2.598	30,0 1.181	36,0 1.417	28,0 1.102	6,0 0.236	140°	TiAIN	IT9
SD1103A-0550-020-06R1 SD_DRILL_5.5MM_3XD_A	02898278	5,5 0.217	20,0 0.787	66,0 2.598	30,0 1.181	36,0 1.417	28,0 1.102	6,0 0.236	140°	TiAIN	IT9
SD1103A-0555-020-06R1 SD_DRILL_5.55MM_3XD_A	02898279	5,55 0.219	20,0 0.787	66,0 2.598	30,0 1.181	36,0 1.417	28,0 1.102	6,0 0.236	140°	TiAIN	IT9
SD1103A-0556-020-06R1 SD_DRILL_7/32_3XD_A	02898280	5,56 0.219	20,0 0.787	66,0 2.598	30,0 1.181	36,0 1.417	28,0 1.102	6,0 0.236	140°	TiAIN	IT9
SD1103A-0560-020-06R1 SD_DRILL_5.6MM_3XD_A	02898281	5,6 0.220	20,0 0.787	66,0 2.598	30,0 1.181	36,0 1.417	28,0 1.102	6,0 0.236	140°	TiAIN	IT9
SD1103A-0570-020-06R1 SD_DRILL_5.7MM_3XD_A	02898282	5,7 0.224	20,0 0.787	66,0 2.598	30,0 1.181	36,0 1.417	28,0 1.102	6,0 0.236	140°	TiAIN	IT9
SD1103A-0580-020-06R1 SD_DRILL_5.8MM_3XD_A	02898283	5,8 0.228	20,0 0.787	66,0 2.598	30,0 1.181	36,0 1.417	28,0 1.102	6,0 0.236	140°	TiAIN	IT9
SD1103A-0590-020-06R1 SD_DRILL_5.9MM_3XD_A	02898284	5,9 0.232	20,0 0.787	66,0 2.598	30,0 1.181	36,0 1.417	28,0 1.102	6,0 0.236	140°	TiAIN	IT9
SD1103A-0595-020-06R1 SD_DRILL_15/64_3XD_A	02898285	5,953 0.234	20,0 0.787	66,0 2.598	30,0 1.181	36,0 1.417	28,0 1.102	6,0 0.236	140°	TiAIN	IT9
SD1103A-0600-020-06R1 SD_DRILL_6.0MM_3XD_A	02898286	6,0 0.236	20,0 0.787	66,0 2.598	30,0 1.181	36,0 1.417	28,0 1.102	6,0 0.236	140°	TiAIN	IT9
SD1103A-0610-024-08R1 SD_DRILL_6.1MM_3XD_A	02898287	6,1 0.240	24,0 0.945	79,0 3.110	43,0 1.693	36,0 1.417	34,0 1.339	8,0 0.315	140°	TiAIN	IT9
SD1103A-0620-024-08R1 SD_DRILL_6.2MM_3XD_A	02898288	6,2 0.244	24,0 0.945	79,0 3.110	43,0 1.693	36,0 1.417	34,0 1.339	8,0 0.315	140°	TiAIN	IT9
SD1103A-0630-024-08R1 SD_DRILL_6.3MM_3XD_A	02898289	6,3 0.248	24,0 0.945	79,0 3.110	43,0 1.693	36,0 1.417	34,0 1.339	8,0 0.315	140°	TiAIN	IT9
SD1103A-0635-024-08R1 SD_DRILL_1/4_3XD_A	02898290	6,35 0.250	24,0 0.945	79,0 3.110	43,0 1.693	36,0 1.417	34,0 1.339	8,0 0.315	140°	TiAIN	IT9
SD1103A-0640-024-08R1 SD_DRILL_6.4MM_3XD_A	02898291	6,4 0.252	24,0 0.945	79,0 3.110	43,0 1.693	36,0 1.417	34,0 1.339	8,0 0.315	140°	TiAIN	IT9
SD1103A-0650-024-08R1 SD_DRILL_6.5MM_3XD_A	02898292	6,5 0.256	24,0 0.945	79,0 3.110	43,0 1.693	36,0 1.417	34,0 1.339	8,0 0.315	140°	TiAIN	IT9
SD1103A-0660-024-08R1 SD_DRILL_6.6MM_3XD_A	02898293	6,6 0.260	24,0 0.945	79,0 3.110	43,0 1.693	36,0 1.417	34,0 1.339	8,0 0.315	140°	TiAIN	IT9
SD1103A-0670-024-08R1 SD_DRILL_6.7MM_3XD_A	02898294	6,7 0.264	24,0 0.945	79,0 3.110	43,0 1.693	36,0 1.417	34,0 1.339	8,0 0.315	140°	TiAIN	IT9
SD1103A-0675-024-08R1 SD_DRILL_17/64_3XD_A	02898295	6,747 0.266	24,0 0.945	79,0 3.110	43,0 1.693	36,0 1.417	34,0 1.339	8,0 0.315	140°	TiAIN	IT9
SD1103A-0680-024-08R1 SD_DRILL_6.8MM_3XD_A	02898296	6,8 0.268	24,0 0.945	79,0 3.110	43,0 1.693	36,0 1.417	34,0 1.339	8,0 0.315	140°	TiAIN	IT9

Wstęp

Wiercenie

Rozwierzanie

Wylaczanie

Załącznik

Oznaczenie	Numer produktu	DC	LU	OAL	LFS	LS	LCF	DMM	Kąt wierzchołkowy	Pokrycie	Tolerancja otworu
		mm Cal.	mm Cal.	mm Cal.	mm Cal.	mm Cal.	mm Cal.	mm Cal.			
SD1103A-0690-024-08R1 SD_DRILL_6.9MM_3XD_A	02898297	6,9 0.272	24,0 0.945	79,0 3.110	43,0 1.693	36,0 1.417	34,0 1.339	8,0 0.315	140°	TiAIN	IT9
SD1103A-0700-024-08R1 SD_DRILL_7.0MM_3XD_A	02898298	7,0 0.276	24,0 0.945	79,0 3.110	43,0 1.693	36,0 1.417	34,0 1.339	8,0 0.315	140°	TiAIN	IT9
SD1103A-0710-029-08R1 SD_DRILL_7.1MM_3XD_A	02898299	7,1 0.280	29,0 1.142	79,0 3.110	43,0 1.693	36,0 1.417	41,0 1.614	8,0 0.315	140°	TiAIN	IT9
SD1103A-0714-029-08R1 SD_DRILL_9/32_3XD_A	02898300	7,144 0.281	29,0 1.142	79,0 3.110	43,0 1.693	36,0 1.417	41,0 1.614	8,0 0.315	140°	TiAIN	IT9
SD1103A-0720-029-08R1 SD_DRILL_7.2MM_3XD_A	02898301	7,2 0.283	29,0 1.142	79,0 3.110	43,0 1.693	36,0 1.417	41,0 1.614	8,0 0.315	140°	TiAIN	IT9
SD1103A-0730-029-08R1 SD_DRILL_7.3MM_3XD_A	02898302	7,3 0.287	29,0 1.142	79,0 3.110	43,0 1.693	36,0 1.417	41,0 1.614	8,0 0.315	140°	TiAIN	IT9
SD1103A-0740-029-08R1 SD_DRILL_7.4MM_3XD_A	02898303	7,4 0.291	29,0 1.142	79,0 3.110	43,0 1.693	36,0 1.417	41,0 1.614	8,0 0.315	140°	TiAIN	IT9
SD1103A-0750-029-08R1 SD_DRILL_7.5MM_3XD_A	02898304	7,5 0.295	29,0 1.142	79,0 3.110	43,0 1.693	36,0 1.417	41,0 1.614	8,0 0.315	140°	TiAIN	IT9
SD1103A-0754-029-08R1 SD_DRILL_19/64_3XD_A	02898305	7,541 0.297	29,0 1.142	79,0 3.110	43,0 1.693	36,0 1.417	41,0 1.614	8,0 0.315	140°	TiAIN	IT9
SD1103A-0755-029-08R1 SD_DRILL_7.55MM_3XD_A	02898306	7,55 0.297	29,0 1.142	79,0 3.110	43,0 1.693	36,0 1.417	41,0 1.614	8,0 0.315	140°	TiAIN	IT9
SD1103A-0760-029-08R1 SD_DRILL_7.6MM_3XD_A	02898307	7,6 0.299	29,0 1.142	79,0 3.110	43,0 1.693	36,0 1.417	41,0 1.614	8,0 0.315	140°	TiAIN	IT9
SD1103A-0770-029-08R1 SD_DRILL_7.7MM_3XD_A	02898308	7,7 0.303	29,0 1.142	79,0 3.110	43,0 1.693	36,0 1.417	41,0 1.614	8,0 0.315	140°	TiAIN	IT9
SD1103A-0780-029-08R1 SD_DRILL_7.8MM_3XD_A	02898309	7,8 0.307	29,0 1.142	79,0 3.110	43,0 1.693	36,0 1.417	41,0 1.614	8,0 0.315	140°	TiAIN	IT9
SD1103A-0790-029-08R1 SD_DRILL_7.9MM_3XD_A	02898310	7,9 0.311	29,0 1.142	79,0 3.110	43,0 1.693	36,0 1.417	41,0 1.614	8,0 0.315	140°	TiAIN	IT9
SD1103A-0794-029-08R1 SD_DRILL_5/16_3XD_A	02898311	7,938 0.313	29,0 1.142	79,0 3.110	43,0 1.693	36,0 1.417	41,0 1.614	8,0 0.315	140°	TiAIN	IT9
SD1103A-0800-029-08R1 SD_DRILL_8.0MM_3XD_A	02898312	8,0 0.315	29,0 1.142	79,0 3.110	43,0 1.693	36,0 1.417	41,0 1.614	8,0 0.315	140°	TiAIN	IT9
SD1103A-0810-035-10R1 SD_DRILL_8.1MM_3XD_A	02898313	8,1 0.319	35,0 1.378	89,0 3.504	49,0 1.929	40,0 1.575	47,0 1.850	10,0 0.394	140°	TiAIN	IT9
SD1103A-0820-035-10R1 SD_DRILL_8.2MM_3XD_A	02898314	8,2 0.323	35,0 1.378	89,0 3.504	49,0 1.929	40,0 1.575	47,0 1.850	10,0 0.394	140°	TiAIN	IT9
SD1103A-0830-035-10R1 SD_DRILL_8.3MM_3XD_A	02898315	8,3 0.327	35,0 1.378	89,0 3.504	49,0 1.929	40,0 1.575	47,0 1.850	10,0 0.394	140°	TiAIN	IT9
SD1103A-0833-035-10R1 SD_DRILL_21/64_3XD_A	02898316	8,334 0.328	35,0 1.378	89,0 3.504	49,0 1.929	40,0 1.575	47,0 1.850	10,0 0.394	140°	TiAIN	IT9
SD1103A-0840-035-10R1 SD_DRILL_8.4MM_3XD_A	02898317	8,4 0.331	35,0 1.378	89,0 3.504	49,0 1.929	40,0 1.575	47,0 1.850	10,0 0.394	140°	TiAIN	IT9
SD1103A-0850-035-10R1 SD_DRILL_8.5MM_3XD_A	02898318	8,5 0.335	35,0 1.378	89,0 3.504	49,0 1.929	40,0 1.575	47,0 1.850	10,0 0.394	140°	TiAIN	IT9
SD1103A-0860-035-10R1 SD_DRILL_8.6MM_3XD_A	02898319	8,6 0.339	35,0 1.378	89,0 3.504	49,0 1.929	40,0 1.575	47,0 1.850	10,0 0.394	140°	TiAIN	IT9
SD1103A-0870-035-10R1 SD_DRILL_8.7MM_3XD_A	02898320	8,7 0.343	35,0 1.378	89,0 3.504	49,0 1.929	40,0 1.575	47,0 1.850	10,0 0.394	140°	TiAIN	IT9
SD1103A-0873-035-10R1 SD_DRILL_11/32_3XD_A	02898321	8,731 0.344	35,0 1.378	89,0 3.504	49,0 1.929	40,0 1.575	47,0 1.850	10,0 0.394	140°	TiAIN	IT9
SD1103A-0880-035-10R1 SD_DRILL_8.8MM_3XD_A	02898322	8,8 0.346	35,0 1.378	89,0 3.504	49,0 1.929	40,0 1.575	47,0 1.850	10,0 0.394	140°	TiAIN	IT9
SD1103A-0890-035-10R1 SD_DRILL_8.9MM_3XD_A	02898323	8,9 0.350	35,0 1.378	89,0 3.504	49,0 1.929	40,0 1.575	47,0 1.850	10,0 0.394	140°	TiAIN	IT9
SD1103A-0900-035-10R1 SD_DRILL_9.0MM_3XD_A	02898324	9,0 0.354	35,0 1.378	89,0 3.504	49,0 1.929	40,0 1.575	47,0 1.850	10,0 0.394	140°	TiAIN	IT9
SD1103A-0910-035-10R1 SD_DRILL_9.1MM_3XD_A	02898325	9,1 0.358	35,0 1.378	89,0 3.504	49,0 1.929	40,0 1.575	47,0 1.850	10,0 0.394	140°	TiAIN	IT9
SD1103A-0913-035-10R1 SD_DRILL_23/64_3XD_A	02898326	9,128 0.359	35,0 1.378	89,0 3.504	49,0 1.929	40,0 1.575	47,0 1.850	10,0 0.394	140°	TiAIN	IT9
SD1103A-0920-035-10R1 SD_DRILL_9.2MM_3XD_A	02898327	9,2 0.362	35,0 1.378	89,0 3.504	49,0 1.929	40,0 1.575	47,0 1.850	10,0 0.394	140°	TiAIN	IT9

Wstęp

Wiercenie

Rozwiercanie

Wytaczanie

Załącznik

Oznaczenie	Numer produktu	DC	LU	OAL	LFS	LS	LCF	DMM	Kąt wierzchołkowy	Pokrycie	Tolerancja otworu
		mm Cal.	mm Cal.	mm Cal.	mm Cal.	mm Cal.	mm Cal.	mm Cal.			
SD1103A-0930-035-10R1 SD_DRILL_9.3MM_3XD_A	02898328	9,3 0.366	35,0 1.378	89,0 3.504	49,0 1.929	40,0 1.575	47,0 1.850	10,0 0.394	140°	TiAIN	IT9
SD1103A-0940-035-10R1 SD_DRILL_9.4MM_3XD_A	02898329	9,4 0.370	35,0 1.378	89,0 3.504	49,0 1.929	40,0 1.575	47,0 1.850	10,0 0.394	140°	TiAIN	IT9
SD1103A-0950-035-10R1 SD_DRILL_9.5MM_3XD_A	02898330	9,5 0.374	35,0 1.378	89,0 3.504	49,0 1.929	40,0 1.575	47,0 1.850	10,0 0.394	140°	TiAIN	IT9
SD1103A-0953-035-10R1 SD_DRILL_3/8_3XD_A	02898331	9,525 0.375	35,0 1.378	89,0 3.504	49,0 1.929	40,0 1.575	47,0 1.850	10,0 0.394	140°	TiAIN	IT9
SD1103A-0955-035-10R1 SD_DRILL_9.55MM_3XD_A	02898332	9,55 0.376	35,0 1.378	89,0 3.504	49,0 1.929	40,0 1.575	47,0 1.850	10,0 0.394	140°	TiAIN	IT9
SD1103A-0960-035-10R1 SD_DRILL_9.6MM_3XD_A	02898333	9,6 0.378	35,0 1.378	89,0 3.504	49,0 1.929	40,0 1.575	47,0 1.850	10,0 0.394	140°	TiAIN	IT9
SD1103A-0970-035-10R1 SD_DRILL_9.7MM_3XD_A	02898334	9,7 0.382	35,0 1.378	89,0 3.504	49,0 1.929	40,0 1.575	47,0 1.850	10,0 0.394	140°	TiAIN	IT9
SD1103A-0980-035-10R1 SD_DRILL_9.8MM_3XD_A	02898335	9,8 0.386	35,0 1.378	89,0 3.504	49,0 1.929	40,0 1.575	47,0 1.850	10,0 0.394	140°	TiAIN	IT9
SD1103A-0990-035-10R1 SD_DRILL_9.9MM_3XD_A	02898336	9,9 0.390	35,0 1.378	89,0 3.504	49,0 1.929	40,0 1.575	47,0 1.850	10,0 0.394	140°	TiAIN	IT9
SD1103A-0992-035-10R1 SD_DRILL_25/64_3XD_A	02898337	9,922 0.391	35,0 1.378	89,0 3.504	49,0 1.929	40,0 1.575	47,0 1.850	10,0 0.394	140°	TiAIN	IT9
SD1103A-1000-035-10R1 SD_DRILL_10.0MM_3XD_A	02898338	10,0 0.394	35,0 1.378	89,0 3.504	49,0 1.929	40,0 1.575	47,0 1.850	10,0 0.394	140°	TiAIN	IT9
SD1103A-1020-040-12R1 SD_DRILL_10.2MM_3XD_A	02898339	10,2 0.402	40,0 1.575	102,0 4.016	57,0 2.244	45,0 1.772	55,0 2.165	12,0 0.472	140°	TiAIN	IT9
SD1103A-1032-040-12R1 SD_DRILL_13/32_3XD_A	02898340	10,319 0.406	40,0 1.575	102,0 4.016	57,0 2.244	45,0 1.772	55,0 2.165	12,0 0.472	140°	TiAIN	IT9
SD1103A-1040-040-12R1 SD_DRILL_10.4MM_3XD_A	02898341	10,4 0.409	40,0 1.575	102,0 4.016	57,0 2.244	45,0 1.772	55,0 2.165	12,0 0.472	140°	TiAIN	IT9
SD1103A-1050-040-12R1 SD_DRILL_10.5MM_3XD_A	02898342	10,5 0.413	40,0 1.575	102,0 4.016	57,0 2.244	45,0 1.772	55,0 2.165	12,0 0.472	140°	TiAIN	IT9
SD1103A-1060-040-12R1 SD_DRILL_10.6MM_3XD_A	02898343	10,6 0.417	40,0 1.575	102,0 4.016	57,0 2.244	45,0 1.772	55,0 2.165	12,0 0.472	140°	TiAIN	IT9
SD1103A-1072-040-12R1 SD_DRILL_27/64_3XD_A	02898344	10,716 0.422	40,0 1.575	102,0 4.016	57,0 2.244	45,0 1.772	55,0 2.165	12,0 0.472	140°	TiAIN	IT9
SD1103A-1080-040-12R1 SD_DRILL_10.8MM_3XD_A	02898345	10,8 0.425	40,0 1.575	102,0 4.016	57,0 2.244	45,0 1.772	55,0 2.165	12,0 0.472	140°	TiAIN	IT9
SD1103A-1090-040-12R1 SD_DRILL_10.9MM_3XD_A	02898346	10,9 0.429	40,0 1.575	102,0 4.016	57,0 2.244	45,0 1.772	55,0 2.165	12,0 0.472	140°	TiAIN	IT9
SD1103A-1100-040-12R1 SD_DRILL_11.0MM_3XD_A	02898347	11,0 0.433	40,0 1.575	102,0 4.016	57,0 2.244	45,0 1.772	55,0 2.165	12,0 0.472	140°	TiAIN	IT9
SD1103A-1110-040-12R1 SD_DRILL_11.1MM_3XD_A	02898348	11,1 0.437	40,0 1.575	102,0 4.016	57,0 2.244	45,0 1.772	55,0 2.165	12,0 0.472	140°	TiAIN	IT9
SD1103A-1111-040-12R1 SD_DRILL_7/16_3XD_A	02898349	11,113 0.438	40,0 1.575	102,0 4.016	57,0 2.244	45,0 1.772	55,0 2.165	12,0 0.472	140°	TiAIN	IT9
SD1103A-1120-040-12R1 SD_DRILL_11.2MM_3XD_A	02898350	11,2 0.441	40,0 1.575	102,0 4.016	57,0 2.244	45,0 1.772	55,0 2.165	12,0 0.472	140°	TiAIN	IT9
SD1103A-1130-040-12R1 SD_DRILL_11.3MM_3XD_A	02898351	11,3 0.445	40,0 1.575	102,0 4.016	57,0 2.244	45,0 1.772	55,0 2.165	12,0 0.472	140°	TiAIN	IT9
SD1103A-1140-040-12R1 SD_DRILL_11.4MM_3XD_A	02898352	11,4 0.449	40,0 1.575	102,0 4.016	57,0 2.244	45,0 1.772	55,0 2.165	12,0 0.472	140°	TiAIN	IT9
SD1103A-1150-040-12R1 SD_DRILL_11.5MM_3XD_A	02898353	11,5 0.453	40,0 1.575	102,0 4.016	57,0 2.244	45,0 1.772	55,0 2.165	12,0 0.472	140°	TiAIN	IT9
SD1103A-1151-040-12R1 SD_DRILL_29/64_3XD_A	02898354	11,509 0.453	40,0 1.575	102,0 4.016	57,0 2.244	45,0 1.772	55,0 2.165	12,0 0.472	140°	TiAIN	IT9
SD1103A-1155-040-12R1 SD_DRILL_11.55MM_3XD_A	02898355	11,55 0.455	40,0 1.575	102,0 4.016	57,0 2.244	45,0 1.772	55,0 2.165	12,0 0.472	140°	TiAIN	IT9
SD1103A-1160-040-12R1 SD_DRILL_11.6MM_3XD_A	02898356	11,6 0.457	40,0 1.575	102,0 4.016	57,0 2.244	45,0 1.772	55,0 2.165	12,0 0.472	140°	TiAIN	IT9
SD1103A-1170-040-12R1 SD_DRILL_11.7MM_3XD_A	02898357	11,7 0.461	40,0 1.575	102,0 4.016	57,0 2.244	45,0 1.772	55,0 2.165	12,0 0.472	140°	TiAIN	IT9
SD1103A-1180-040-12R1 SD_DRILL_11.8MM_3XD_A	02898358	11,8 0.465	40,0 1.575	102,0 4.016	57,0 2.244	45,0 1.772	55,0 2.165	12,0 0.472	140°	TiAIN	IT9

Oznaczenie	Numer produktu	DC	LU	OAL	LFS	LS	LCF	DMM	Kąt wierzchołkowy	Pokrycie	Tolerancja otworu
		mm Cal.	mm Cal.	mm Cal.	mm Cal.	mm Cal.	mm Cal.	mm Cal.			
SD1103A-1190-040-12R1 SD_DRILL_11.9MM_3XD_A	02898359	11,9 0.469	40,0 1.575	102,0 4.016	57,0 2.244	45,0 1.772	55,0 2.165	12,0 0.472	140°	TiAIN	IT9
SD1103A-1191-040-12R1 SD_DRILL_15/32_3XD_A	02898360	11,906 0.469	40,0 1.575	102,0 4.016	57,0 2.244	45,0 1.772	55,0 2.165	12,0 0.472	140°	TiAIN	IT9
SD1103A-1200-040-12R1 SD_DRILL_12.0MM_3XD_A	02898361	12,0 0.472	40,0 1.575	102,0 4.016	57,0 2.244	45,0 1.772	55,0 2.165	12,0 0.472	140°	TiAIN	IT9
SD1103A-1210-043-14R1 SD_DRILL_12.1MM_3XD_A	02898362	12,1 0.476	43,0 1.693	107,0 4.213	62,0 2.441	45,0 1.772	60,0 2.362	14,0 0.551	140°	TiAIN	IT9
SD1103A-1220-043-14R1 SD_DRILL_12.2MM_3XD_A	02898363	12,2 0.480	43,0 1.693	107,0 4.213	62,0 2.441	45,0 1.772	60,0 2.362	14,0 0.551	140°	TiAIN	IT9
SD1103A-1230-043-14R1 SD_DRILL_31/64_3XD_A	02898364	12,303 0.484	43,0 1.693	107,0 4.213	62,0 2.441	45,0 1.772	60,0 2.362	14,0 0.551	140°	TiAIN	IT9
SD1103A-1240-043-14R1 SD_DRILL_12.4MM_3XD_A	02898365	12,4 0.488	43,0 1.693	107,0 4.213	62,0 2.441	45,0 1.772	60,0 2.362	14,0 0.551	140°	TiAIN	IT9
SD1103A-1250-043-14R1 SD_DRILL_12.5MM_3XD_A	02898366	12,5 0.492	43,0 1.693	107,0 4.213	62,0 2.441	45,0 1.772	60,0 2.362	14,0 0.551	140°	TiAIN	IT9
SD1103A-1260-043-14R1 SD_DRILL_12.6MM_3XD_A	02898367	12,6 0.496	43,0 1.693	107,0 4.213	62,0 2.441	45,0 1.772	60,0 2.362	14,0 0.551	140°	TiAIN	IT9
SD1103A-1270-043-14R1 SD_DRILL_1/2_3XD_A	02898368	12,7 0.500	43,0 1.693	107,0 4.213	62,0 2.441	45,0 1.772	60,0 2.362	14,0 0.551	140°	TiAIN	IT9
SD1103A-1275-043-14R1 SD_DRILL_12.75MM_3XD_A	02898369	12,75 0.502	43,0 1.693	107,0 4.213	62,0 2.441	45,0 1.772	60,0 2.362	14,0 0.551	140°	TiAIN	IT9
SD1103A-1280-043-14R1 SD_DRILL_12.8MM_3XD_A	02898370	12,8 0.504	43,0 1.693	107,0 4.213	62,0 2.441	45,0 1.772	60,0 2.362	14,0 0.551	140°	TiAIN	IT9
SD1103A-1290-043-14R1 SD_DRILL_12.9MM_3XD_A	02898371	12,9 0.508	43,0 1.693	107,0 4.213	62,0 2.441	45,0 1.772	60,0 2.362	14,0 0.551	140°	TiAIN	IT9
SD1103A-1300-043-14R1 SD_DRILL_13.0MM_3XD_A	02898372	13,0 0.512	43,0 1.693	107,0 4.213	62,0 2.441	45,0 1.772	60,0 2.362	14,0 0.551	140°	TiAIN	IT9
SD1103A-1310-043-14R1 SD_DRILL_33/64_3XD_A	02898373	13,1 0.516	43,0 1.693	107,0 4.213	62,0 2.441	45,0 1.772	60,0 2.362	14,0 0.551	140°	TiAIN	IT9
SD1103A-1320-043-14R1 SD_DRILL_13.2MM_3XD_A	02898374	13,2 0.520	43,0 1.693	107,0 4.213	62,0 2.441	45,0 1.772	60,0 2.362	14,0 0.551	140°	TiAIN	IT9
SD1103A-1330-043-14R1 SD_DRILL_13.3MM_3XD_A	02898375	13,3 0.524	43,0 1.693	107,0 4.213	62,0 2.441	45,0 1.772	60,0 2.362	14,0 0.551	140°	TiAIN	IT9
SD1103A-1340-043-14R1 SD_DRILL_13.4MM_3XD_A	02898376	13,4 0.528	43,0 1.693	107,0 4.213	62,0 2.441	45,0 1.772	60,0 2.362	14,0 0.551	140°	TiAIN	IT9
SD1103A-1349-043-14R1 SD_DRILL_17/32_3XD_A	02898377	13,494 0.531	43,0 1.693	107,0 4.213	62,0 2.441	45,0 1.772	60,0 2.362	14,0 0.551	140°	TiAIN	IT9
SD1103A-1350-043-14R1 SD_DRILL_13.5MM_3XD_A	02898378	13,5 0.531	43,0 1.693	107,0 4.213	62,0 2.441	45,0 1.772	60,0 2.362	14,0 0.551	140°	TiAIN	IT9
SD1103A-1360-043-14R1 SD_DRILL_13.6MM_3XD_A	02898379	13,6 0.535	43,0 1.693	107,0 4.213	62,0 2.441	45,0 1.772	60,0 2.362	14,0 0.551	140°	TiAIN	IT9
SD1103A-1370-043-14R1 SD_DRILL_13.7MM_3XD_A	02898380	13,7 0.539	43,0 1.693	107,0 4.213	62,0 2.441	45,0 1.772	60,0 2.362	14,0 0.551	140°	TiAIN	IT9
SD1103A-1380-043-14R1 SD_DRILL_13.8MM_3XD_A	02898381	13,8 0.543	43,0 1.693	107,0 4.213	62,0 2.441	45,0 1.772	60,0 2.362	14,0 0.551	140°	TiAIN	IT9
SD1103A-1390-043-14R1 SD_DRILL_13.9MM_3XD_A	02898382	13,9 0.547	43,0 1.693	107,0 4.213	62,0 2.441	45,0 1.772	60,0 2.362	14,0 0.551	140°	TiAIN	IT9
SD1103A-1400-043-14R1 SD_DRILL_14.0MM_3XD_A	02898383	14,0 0.551	43,0 1.693	107,0 4.213	62,0 2.441	45,0 1.772	60,0 2.362	14,0 0.551	140°	TiAIN	IT9
SD1103A-1420-045-16R1 SD_DRILL_14.2MM_3XD_A	02898384	14,2 0.559	45,0 1.772	115,0 4.528	67,0 2.638	48,0 1.890	65,0 2.559	16,0 0.630	140°	TiAIN	IT9
SD1103A-1429-045-16R1 SD_DRILL_9/16_3XD_A	02898385	14,288 0.563	45,0 1.772	115,0 4.528	67,0 2.638	48,0 1.890	65,0 2.559	16,0 0.630	140°	TiAIN	IT9
SD1103A-1450-045-16R1 SD_DRILL_14.5MM_3XD_A	02898386	14,5 0.571	45,0 1.772	115,0 4.528	67,0 2.638	48,0 1.890	65,0 2.559	16,0 0.630	140°	TiAIN	IT9
SD1103A-1470-045-16R1 SD_DRILL_14.7MM_3XD_A	02898387	14,7 0.579	45,0 1.772	115,0 4.528	67,0 2.638	48,0 1.890	65,0 2.559	16,0 0.630	140°	TiAIN	IT9
SD1103A-1475-045-16R1 SD_DRILL_14.75MM_3XD_A	02898388	14,75 0.581	45,0 1.772	115,0 4.528	67,0 2.638	48,0 1.890	65,0 2.559	16,0 0.630	140°	TiAIN	IT9
SD1103A-1480-045-16R1 SD_DRILL_14.8MM_3XD_A	02898389	14,8 0.583	45,0 1.772	115,0 4.528	67,0 2.638	48,0 1.890	65,0 2.559	16,0 0.630	140°	TiAIN	IT9

Oznaczenie	Numer produktu	DC	LU	OAL	LFS	LS	LCF	DMM	Kąt wierzchołkowy	Pokrycie	Tolerancja otworu
		mm Cal.	mm Cal.	mm Cal.	mm Cal.	mm Cal.	mm Cal.	mm Cal.	mm Cal.		
SD1103A-1500-045-16R1 SD_DRILL_15.0MM_3XD_A	02898390	15,0 0.591	45,0 1.772	115,0 4.528	67,0 2.638	48,0 1.890	65,0 2.559	16,0 0.630	140°	TiAIN	IT9
SD1103A-1510-045-16R1 SD_DRILL_15.1MM_3XD_A	02898391	15,1 0.594	45,0 1.772	115,0 4.528	67,0 2.638	48,0 1.890	65,0 2.559	16,0 0.630	140°	TiAIN	IT9
SD1103A-1530-045-16R1 SD_DRILL_15.3MM_3XD_A	02898392	15,3 0.602	45,0 1.772	115,0 4.528	67,0 2.638	48,0 1.890	65,0 2.559	16,0 0.630	140°	TiAIN	IT9
SD1103A-1550-045-16R1 SD_DRILL_15.5MM_3XD_A	02898393	15,5 0.610	45,0 1.772	115,0 4.528	67,0 2.638	48,0 1.890	65,0 2.559	16,0 0.630	140°	TiAIN	IT9
SD1103A-1570-045-16R1 SD_DRILL_15.7MM_3XD_A	02898394	15,7 0.618	45,0 1.772	115,0 4.528	67,0 2.638	48,0 1.890	65,0 2.559	16,0 0.630	140°	TiAIN	IT9
SD1103A-1580-045-16R1 SD_DRILL_15.8MM_3XD_A	02898395	15,8 0.622	45,0 1.772	115,0 4.528	67,0 2.638	48,0 1.890	65,0 2.559	16,0 0.630	140°	TiAIN	IT9
SD1103A-1588-045-16R1 SD_DRILL_5/8_3XD_A	02898396	15,875 0.625	45,0 1.772	115,0 4.528	67,0 2.638	48,0 1.890	65,0 2.559	16,0 0.630	140°	TiAIN	IT9
SD1103A-1600-045-16R1 SD_DRILL_16.0MM_3XD_A	02898397	16,0 0.630	45,0 1.772	115,0 4.528	67,0 2.638	48,0 1.890	65,0 2.559	16,0 0.630	140°	TiAIN	IT9
SD1103A-1650-051-18R1 SD_DRILL_16.5MM_3XD_A	02898398	16,5 0.650	51,0 2.008	123,0 4.843	75,0 2.953	48,0 1.890	73,0 2.874	18,0 0.709	140°	TiAIN	IT9
SD1103A-1700-051-18R1 SD_DRILL_17.0MM_3XD_A	02898399	17,0 0.669	51,0 2.008	123,0 4.843	75,0 2.953	48,0 1.890	73,0 2.874	18,0 0.709	140°	TiAIN	IT9
SD1103A-1750-051-18R1 SD_DRILL_17.5MM_3XD_A	02898400	17,5 0.689	51,0 2.008	123,0 4.843	75,0 2.953	48,0 1.890	73,0 2.874	18,0 0.709	140°	TiAIN	IT9
SD1103A-1800-051-18R1 SD_DRILL_18.0MM_3XD_A	02898401	18,0 0.709	51,0 2.008	123,0 4.843	75,0 2.953	48,0 1.890	73,0 2.874	18,0 0.709	140°	TiAIN	IT9
SD1103A-1850-055-20R1 SD_DRILL_18.5MM_3XD_A	02898402	18,5 0.728	55,0 2.165	131,0 5.157	81,0 3.189	50,0 1.969	79,0 3.110	20,0 0.787	140°	TiAIN	IT9
SD1103A-1900-055-20R1 SD_DRILL_19.0MM_3XD_A	02898403	19,0 0.748	55,0 2.165	131,0 5.157	81,0 3.189	50,0 1.969	79,0 3.110	20,0 0.787	140°	TiAIN	IT9
SD1103A-1905-055-20R1 SD_DRILL_3/4_3XD_A	02898404	19,05 0.750	55,0 2.165	131,0 5.157	81,0 3.189	50,0 1.969	79,0 3.110	20,0 0.787	140°	TiAIN	IT9
SD1103A-1950-055-20R1 SD_DRILL_19.5MM_3XD_A	02898405	19,5 0.768	55,0 2.165	131,0 5.157	81,0 3.189	50,0 1.969	79,0 3.110	20,0 0.787	140°	TiAIN	IT9
SD1103A-2000-055-20R1 SD_DRILL_20.0MM_3XD_A	02898406	20,0 0.787	55,0 2.165	131,0 5.157	81,0 3.189	50,0 1.969	79,0 3.110	20,0 0.787	140°	TiAIN	IT9

Wstęp

Wiercenie

Rozwiercanie

Wyłaczanie

Załącznik

SD1105A

Głębokość wiercenia ~ 5 x D – Metryczne/Calowe

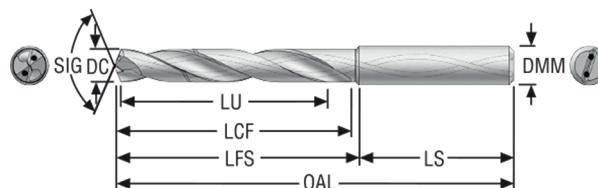
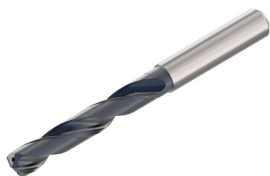

- Chwyt cylindryczny DIN 6537A
- Chłodzenie wewnętrzne
- Parametry skrawania, patrz strona (strony) 141
- Średnice pośrednie patrz aplikacja MyDesign.

Oznaczenie	Numer produktu	DC	LU	OAL	LFS	LS	LCF	DMM	Kąt wierzchołkowy	Pokrycie	Tolerancja otworu
		mm Cal.	mm Cal.	mm Cal.	mm Cal.	mm Cal.	mm Cal.	mm Cal.			
SD1105A-0300-023-06R1 SD_DRILL_3.0MM_5XD_A	02897845	3,0 0.118	23,0 0.906	66,0 2.598	30,0 1.181	36,0 1.417	28,0 1.102	6,0 0.236	140°	TiAIN	IT9
SD1105A-0310-023-06R1 SD_DRILL_3.1MM_5XD_A	02897846	3,1 0.122	23,0 0.906	66,0 2.598	30,0 1.181	36,0 1.417	28,0 1.102	6,0 0.236	140°	TiAIN	IT9
SD1105A-0318-023-06R1 SD_DRILL_1/8_5XD_A	02897847	3,175 0.125	23,0 0.906	66,0 2.598	30,0 1.181	36,0 1.417	28,0 1.102	6,0 0.236	140°	TiAIN	IT9
SD1105A-0320-023-06R1 SD_DRILL_3.2MM_5XD_A	02897848	3,2 0.126	23,0 0.906	66,0 2.598	30,0 1.181	36,0 1.417	28,0 1.102	6,0 0.236	140°	TiAIN	IT9
SD1105A-0325-023-06R1 SD_DRILL_3.25MM_5XD_A	02897849	3,25 0.128	23,0 0.906	66,0 2.598	30,0 1.181	36,0 1.417	28,0 1.102	6,0 0.236	140°	TiAIN	IT9
SD1105A-0330-023-06R1 SD_DRILL_3.3MM_5XD_A	02897850	3,3 0.130	23,0 0.906	66,0 2.598	30,0 1.181	36,0 1.417	28,0 1.102	6,0 0.236	140°	TiAIN	IT9
SD1105A-0340-023-06R1 SD_DRILL_3.4MM_5XD_A	02897851	3,4 0.134	23,0 0.906	66,0 2.598	30,0 1.181	36,0 1.417	28,0 1.102	6,0 0.236	140°	TiAIN	IT9
SD1105A-0350-023-06R1 SD_DRILL_3.5MM_5XD_A	02897852	3,5 0.138	23,0 0.906	66,0 2.598	30,0 1.181	36,0 1.417	28,0 1.102	6,0 0.236	140°	TiAIN	IT9
SD1105A-0357-023-06R1 SD_DRILL_9/64_5XD_A	02897853	3,572 0.141	23,0 0.906	66,0 2.598	30,0 1.181	36,0 1.417	28,0 1.102	6,0 0.236	140°	TiAIN	IT9
SD1105A-0360-023-06R1 SD_DRILL_3.6MM_5XD_A	02897854	3,6 0.142	23,0 0.906	66,0 2.598	30,0 1.181	36,0 1.417	28,0 1.102	6,0 0.236	140°	TiAIN	IT9
SD1105A-0365-023-06R1 SD_DRILL_3.65MM_5XD_A	02897855	3,65 0.144	23,0 0.906	66,0 2.598	30,0 1.181	36,0 1.417	28,0 1.102	6,0 0.236	140°	TiAIN	IT9
SD1105A-0370-023-06R1 SD_DRILL_3.7MM_5XD_A	02897856	3,7 0.146	23,0 0.906	66,0 2.598	30,0 1.181	36,0 1.417	28,0 1.102	6,0 0.236	140°	TiAIN	IT9
SD1105A-0380-029-06R1 SD_DRILL_3.8MM_5XD_A	02897857	3,8 0.150	29,0 1.142	74,0 2.913	38,0 1.496	36,0 1.417	36,0 1.417	6,0 0.236	140°	TiAIN	IT9
SD1105A-0390-029-06R1 SD_DRILL_3.9MM_5XD_A	02897858	3,9 0.154	29,0 1.142	74,0 2.913	38,0 1.496	36,0 1.417	36,0 1.417	6,0 0.236	140°	TiAIN	IT9
SD1105A-0397-029-06R1 SD_DRILL_5/32_5XD_A	02897859	3,969 0.156	29,0 1.142	74,0 2.913	38,0 1.496	36,0 1.417	36,0 1.417	6,0 0.236	140°	TiAIN	IT9
SD1105A-0400-029-06R1 SD_DRILL_4.0MM_5XD_A	02897860	4,0 0.157	29,0 1.142	74,0 2.913	38,0 1.496	36,0 1.417	36,0 1.417	6,0 0.236	140°	TiAIN	IT9
SD1105A-0410-029-06R1 SD_DRILL_4.1MM_5XD_A	02897861	4,1 0.161	29,0 1.142	74,0 2.913	38,0 1.496	36,0 1.417	36,0 1.417	6,0 0.236	140°	TiAIN	IT9
SD1105A-0420-029-06R1 SD_DRILL_4.2MM_5XD_A	02897862	4,2 0.165	29,0 1.142	74,0 2.913	38,0 1.496	36,0 1.417	36,0 1.417	6,0 0.236	140°	TiAIN	IT9
SD1105A-0430-029-06R1 SD_DRILL_4.3MM_5XD_A	02897863	4,3 0.169	29,0 1.142	74,0 2.913	38,0 1.496	36,0 1.417	36,0 1.417	6,0 0.236	140°	TiAIN	IT9
SD1105A-0437-029-06R1 SD_DRILL_11/64_5XD_A	02897864	4,366 0.172	29,0 1.142	74,0 2.913	38,0 1.496	36,0 1.417	36,0 1.417	6,0 0.236	140°	TiAIN	IT9
SD1105A-0440-029-06R1 SD_DRILL_4.4MM_5XD_A	02897865	4,4 0.173	29,0 1.142	74,0 2.913	38,0 1.496	36,0 1.417	36,0 1.417	6,0 0.236	140°	TiAIN	IT9
SD1105A-0450-029-06R1 SD_DRILL_4.5MM_5XD_A	02897866	4,5 0.177	29,0 1.142	74,0 2.913	38,0 1.496	36,0 1.417	36,0 1.417	6,0 0.236	140°	TiAIN	IT9

Wstęp

Wiercenie

Rozwiercanie

Wyłaczanie

Załącznik

Oznaczenie	Numer produktu	DC	LU	OAL	LFS	LS	LCF	DMM	Kąt wierzchołkowy	Pokrycie	Tolerancja otworu
		mm Cal.	mm Cal.	mm Cal.	mm Cal.	mm Cal.	mm Cal.	mm Cal.	°		
SD1105A-0460-029-06R1 SD_DRILL_4.6MM_5XD_A	02897867	4,6 0.181	29,0 1.142	74,0 2.913	38,0 1.496	36,0 1.417	36,0 1.417	6,0 0.236	140°	TiAIN	IT9
SD1105A-0465-029-06R1 SD_DRILL_4.65MM_5XD_A	02897868	4,65 0.183	29,0 1.142	74,0 2.913	38,0 1.496	36,0 1.417	36,0 1.417	6,0 0.236	140°	TiAIN	IT9
SD1105A-0470-029-06R1 SD_DRILL_4.7MM_5XD_A	02897869	4,7 0.185	29,0 1.142	74,0 2.913	38,0 1.496	36,0 1.417	36,0 1.417	6,0 0.236	140°	TiAIN	IT9
SD1105A-0476-035-06R1 SD_DRILL_3/16_5XD_A	02897870	4,763 0.188	35,0 1.378	82,0 3.228	46,0 1.811	36,0 1.417	44,0 1.732	6,0 0.236	140°	TiAIN	IT9
SD1105A-0480-035-06R1 SD_DRILL_4.8MM_5XD_A	02897871	4,8 0.189	35,0 1.378	82,0 3.228	46,0 1.811	36,0 1.417	44,0 1.732	6,0 0.236	140°	TiAIN	IT9
SD1105A-0490-035-06R1 SD_DRILL_4.9MM_5XD_A	02897872	4,9 0.193	35,0 1.378	82,0 3.228	46,0 1.811	36,0 1.417	44,0 1.732	6,0 0.236	140°	TiAIN	IT9
SD1105A-0500-035-06R1 SD_DRILL_5.0MM_5XD_A	02897873	5,0 0.197	35,0 1.378	82,0 3.228	46,0 1.811	36,0 1.417	44,0 1.732	6,0 0.236	140°	TiAIN	IT9
SD1105A-0510-035-06R1 SD_DRILL_5.1MM_5XD_A	02897874	5,1 0.201	35,0 1.378	82,0 3.228	46,0 1.811	36,0 1.417	44,0 1.732	6,0 0.236	140°	TiAIN	IT9
SD1105A-0516-035-06R1 SD_DRILL_13/64_5XD_A	02897875	5,159 0.203	35,0 1.378	82,0 3.228	46,0 1.811	36,0 1.417	44,0 1.732	6,0 0.236	140°	TiAIN	IT9
SD1105A-0520-035-06R1 SD_DRILL_5.2MM_5XD_A	02897876	5,2 0.205	35,0 1.378	82,0 3.228	46,0 1.811	36,0 1.417	44,0 1.732	6,0 0.236	140°	TiAIN	IT9
SD1105A-0530-035-06R1 SD_DRILL_5.3MM_5XD_A	02897877	5,3 0.209	35,0 1.378	82,0 3.228	46,0 1.811	36,0 1.417	44,0 1.732	6,0 0.236	140°	TiAIN	IT9
SD1105A-0540-035-06R1 SD_DRILL_5.4MM_5XD_A	02897878	5,4 0.213	35,0 1.378	82,0 3.228	46,0 1.811	36,0 1.417	44,0 1.732	6,0 0.236	140°	TiAIN	IT9
SD1105A-0550-035-06R1 SD_DRILL_5.5MM_5XD_A	02897879	5,5 0.217	35,0 1.378	82,0 3.228	46,0 1.811	36,0 1.417	44,0 1.732	6,0 0.236	140°	TiAIN	IT9
SD1105A-0555-035-06R1 SD_DRILL_5.55MM_5XD_A	02897880	5,55 0.219	35,0 1.378	82,0 3.228	46,0 1.811	36,0 1.417	44,0 1.732	6,0 0.236	140°	TiAIN	IT9
SD1105A-0556-035-06R1 SD_DRILL_7/32_5XD_A	02897881	5,56 0.219	35,0 1.378	82,0 3.228	46,0 1.811	36,0 1.417	44,0 1.732	6,0 0.236	140°	TiAIN	IT9
SD1105A-0560-035-06R1 SD_DRILL_5.6MM_5XD_A	02897882	5,6 0.220	35,0 1.378	82,0 3.228	46,0 1.811	36,0 1.417	44,0 1.732	6,0 0.236	140°	TiAIN	IT9
SD1105A-0570-035-06R1 SD_DRILL_5.7MM_5XD_A	02897883	5,7 0.224	35,0 1.378	82,0 3.228	46,0 1.811	36,0 1.417	44,0 1.732	6,0 0.236	140°	TiAIN	IT9
SD1105A-0580-035-06R1 SD_DRILL_5.8MM_5XD_A	02897884	5,8 0.228	35,0 1.378	82,0 3.228	46,0 1.811	36,0 1.417	44,0 1.732	6,0 0.236	140°	TiAIN	IT9
SD1105A-0590-035-06R1 SD_DRILL_5.9MM_5XD_A	02897885	5,9 0.232	35,0 1.378	82,0 3.228	46,0 1.811	36,0 1.417	44,0 1.732	6,0 0.236	140°	TiAIN	IT9
SD1105A-0595-035-06R1 SD_DRILL_15/64_5XD_A	02897886	5,953 0.234	35,0 1.378	82,0 3.228	46,0 1.811	36,0 1.417	44,0 1.732	6,0 0.236	140°	TiAIN	IT9
SD1105A-0600-035-06R1 SD_DRILL_6.0MM_5XD_A	02897887	6,0 0.236	35,0 1.378	82,0 3.228	46,0 1.811	36,0 1.417	44,0 1.732	6,0 0.236	140°	TiAIN	IT9
SD1105A-0610-043-08R1 SD_DRILL_6.1MM_5XD_A	02897888	6,1 0.240	43,0 1.693	91,0 3.583	55,0 2.165	36,0 1.417	53,0 2.087	8,0 0.315	140°	TiAIN	IT9
SD1105A-0620-043-08R1 SD_DRILL_6.2MM_5XD_A	02897889	6,2 0.244	43,0 1.693	91,0 3.583	55,0 2.165	36,0 1.417	53,0 2.087	8,0 0.315	140°	TiAIN	IT9
SD1105A-0630-043-08R1 SD_DRILL_6.3MM_5XD_A	02897890	6,3 0.248	43,0 1.693	91,0 3.583	55,0 2.165	36,0 1.417	53,0 2.087	8,0 0.315	140°	TiAIN	IT9
SD1105A-0635-043-08R1 SD_DRILL_1/4_5XD_A	02897891	6,35 0.250	43,0 1.693	91,0 3.583	55,0 2.165	36,0 1.417	53,0 2.087	8,0 0.315	140°	TiAIN	IT9
SD1105A-0640-043-08R1 SD_DRILL_6.4MM_5XD_A	02897892	6,4 0.252	43,0 1.693	91,0 3.583	55,0 2.165	36,0 1.417	53,0 2.087	8,0 0.315	140°	TiAIN	IT9
SD1105A-0650-043-08R1 SD_DRILL_6.5MM_5XD_A	02897893	6,5 0.256	43,0 1.693	91,0 3.583	55,0 2.165	36,0 1.417	53,0 2.087	8,0 0.315	140°	TiAIN	IT9
SD1105A-0660-043-08R1 SD_DRILL_6.6MM_5XD_A	02897894	6,6 0.260	43,0 1.693	91,0 3.583	55,0 2.165	36,0 1.417	53,0 2.087	8,0 0.315	140°	TiAIN	IT9
SD1105A-0670-043-08R1 SD_DRILL_6.7MM_5XD_A	02897895	6,7 0.264	43,0 1.693	91,0 3.583	55,0 2.165	36,0 1.417	53,0 2.087	8,0 0.315	140°	TiAIN	IT9
SD1105A-0675-043-08R1 SD_DRILL_17/64_5XD_A	02897896	6,747 0.266	43,0 1.693	91,0 3.583	55,0 2.165	36,0 1.417	53,0 2.087	8,0 0.315	140°	TiAIN	IT9
SD1105A-0680-043-08R1 SD_DRILL_6.8MM_5XD_A	02897897	6,8 0.268	43,0 1.693	91,0 3.583	55,0 2.165	36,0 1.417	53,0 2.087	8,0 0.315	140°	TiAIN	IT9

Wstęp

Wiercenie

Rozwiercanie

Wylaczanie

Zalacznik

Oznaczenie	Numer produktu	DC	LU	OAL	LFS	LS	LCF	DMM	Kąt wierzchołkowy	Pokrycie	Tolerancja otworu
		mm Cal.	mm Cal.	mm Cal.	mm Cal.	mm Cal.	mm Cal.	mm Cal.			
SD1105A-0690-043-08R1 SD_DRILL_6.9MM_5XD_A	02897898	6,9 0.272	43,0 1.693	91,0 3.583	55,0 2.165	36,0 1.417	53,0 2.087	8,0 0.315	140°	TiAIN	IT9
SD1105A-0700-043-08R1 SD_DRILL_7.0MM_5XD_A	02897899	7,0 0.276	43,0 1.693	91,0 3.583	55,0 2.165	36,0 1.417	53,0 2.087	8,0 0.315	140°	TiAIN	IT9
SD1105A-0710-043-08R1 SD_DRILL_7.1MM_5XD_A	02897900	7,1 0.280	43,0 1.693	91,0 3.583	55,0 2.165	36,0 1.417	53,0 2.087	8,0 0.315	140°	TiAIN	IT9
SD1105A-0714-043-08R1 SD_DRILL_9/32_5XD_A	02897901	7,144 0.281	43,0 1.693	91,0 3.583	55,0 2.165	36,0 1.417	53,0 2.087	8,0 0.315	140°	TiAIN	IT9
SD1105A-0720-043-08R1 SD_DRILL_7.2MM_5XD_A	02897902	7,2 0.283	43,0 1.693	91,0 3.583	55,0 2.165	36,0 1.417	53,0 2.087	8,0 0.315	140°	TiAIN	IT9
SD1105A-0730-043-08R1 SD_DRILL_7.3MM_5XD_A	02897903	7,3 0.287	43,0 1.693	91,0 3.583	55,0 2.165	36,0 1.417	53,0 2.087	8,0 0.315	140°	TiAIN	IT9
SD1105A-0740-043-08R1 SD_DRILL_7.4MM_5XD_A	02897904	7,4 0.291	43,0 1.693	91,0 3.583	55,0 2.165	36,0 1.417	53,0 2.087	8,0 0.315	140°	TiAIN	IT9
SD1105A-0750-043-08R1 SD_DRILL_7.5MM_5XD_A	02897905	7,5 0.295	43,0 1.693	91,0 3.583	55,0 2.165	36,0 1.417	53,0 2.087	8,0 0.315	140°	TiAIN	IT9
SD1105A-0754-043-08R1 SD_DRILL_19/64_5XD_A	02897906	7,541 0.297	43,0 1.693	91,0 3.583	55,0 2.165	36,0 1.417	53,0 2.087	8,0 0.315	140°	TiAIN	IT9
SD1105A-0755-043-08R1 SD_DRILL_7.55MM_5XD_A	02897907	7,55 0.297	43,0 1.693	91,0 3.583	55,0 2.165	36,0 1.417	53,0 2.087	8,0 0.315	140°	TiAIN	IT9
SD1105A-0760-043-08R1 SD_DRILL_7.6MM_5XD_A	02897908	7,6 0.299	43,0 1.693	91,0 3.583	55,0 2.165	36,0 1.417	53,0 2.087	8,0 0.315	140°	TiAIN	IT9
SD1105A-0770-043-08R1 SD_DRILL_7.7MM_5XD_A	02897909	7,7 0.303	43,0 1.693	91,0 3.583	55,0 2.165	36,0 1.417	53,0 2.087	8,0 0.315	140°	TiAIN	IT9
SD1105A-0780-043-08R1 SD_DRILL_7.8MM_5XD_A	02897910	7,8 0.307	43,0 1.693	91,0 3.583	55,0 2.165	36,0 1.417	53,0 2.087	8,0 0.315	140°	TiAIN	IT9
SD1105A-0790-043-08R1 SD_DRILL_7.9MM_5XD_A	02897911	7,9 0.311	43,0 1.693	91,0 3.583	55,0 2.165	36,0 1.417	53,0 2.087	8,0 0.315	140°	TiAIN	IT9
SD1105A-0794-043-08R1 SD_DRILL_5/16_5XD_A	02897912	7,938 0.313	43,0 1.693	91,0 3.583	55,0 2.165	36,0 1.417	53,0 2.087	8,0 0.315	140°	TiAIN	IT9
SD1105A-0800-043-08R1 SD_DRILL_8.0MM_5XD_A	02897913	8,0 0.315	43,0 1.693	91,0 3.583	55,0 2.165	36,0 1.417	53,0 2.087	8,0 0.315	140°	TiAIN	IT9
SD1105A-0810-049-10R1 SD_DRILL_8.1MM_5XD_A	02897914	8,1 0.319	49,0 1.929	103,0 4.055	63,0 2.480	40,0 1.575	61,0 2.402	10,0 0.394	140°	TiAIN	IT9
SD1105A-0820-049-10R1 SD_DRILL_8.2MM_5XD_A	02897915	8,2 0.323	49,0 1.929	103,0 4.055	63,0 2.480	40,0 1.575	61,0 2.402	10,0 0.394	140°	TiAIN	IT9
SD1105A-0830-049-10R1 SD_DRILL_8.3MM_5XD_A	02897916	8,3 0.327	49,0 1.929	103,0 4.055	63,0 2.480	40,0 1.575	61,0 2.402	10,0 0.394	140°	TiAIN	IT9
SD1105A-0833-049-10R1 SD_DRILL_21/64_5XD_A	02897917	8,334 0.328	49,0 1.929	103,0 4.055	63,0 2.480	40,0 1.575	61,0 2.402	10,0 0.394	140°	TiAIN	IT9
SD1105A-0840-049-10R1 SD_DRILL_8.4MM_5XD_A	02897918	8,4 0.331	49,0 1.929	103,0 4.055	63,0 2.480	40,0 1.575	61,0 2.402	10,0 0.394	140°	TiAIN	IT9
SD1105A-0850-049-10R1 SD_DRILL_8.5MM_5XD_A	02897919	8,5 0.335	49,0 1.929	103,0 4.055	63,0 2.480	40,0 1.575	61,0 2.402	10,0 0.394	140°	TiAIN	IT9
SD1105A-0860-049-10R1 SD_DRILL_8.6MM_5XD_A	02897920	8,6 0.339	49,0 1.929	103,0 4.055	63,0 2.480	40,0 1.575	61,0 2.402	10,0 0.394	140°	TiAIN	IT9
SD1105A-0870-049-10R1 SD_DRILL_8.7MM_5XD_A	02897921	8,7 0.343	49,0 1.929	103,0 4.055	63,0 2.480	40,0 1.575	61,0 2.402	10,0 0.394	140°	TiAIN	IT9
SD1105A-0873-049-10R1 SD_DRILL_11/32_5XD_A	02897922	8,731 0.344	49,0 1.929	103,0 4.055	63,0 2.480	40,0 1.575	61,0 2.402	10,0 0.394	140°	TiAIN	IT9
SD1105A-0880-049-10R1 SD_DRILL_8.8MM_5XD_A	02897923	8,8 0.346	49,0 1.929	103,0 4.055	63,0 2.480	40,0 1.575	61,0 2.402	10,0 0.394	140°	TiAIN	IT9
SD1105A-0890-049-10R1 SD_DRILL_8.9MM_5XD_A	02897924	8,9 0.350	49,0 1.929	103,0 4.055	63,0 2.480	40,0 1.575	61,0 2.402	10,0 0.394	140°	TiAIN	IT9
SD1105A-0900-049-10R1 SD_DRILL_9.0MM_5XD_A	02897925	9,0 0.354	49,0 1.929	103,0 4.055	63,0 2.480	40,0 1.575	61,0 2.402	10,0 0.394	140°	TiAIN	IT9
SD1105A-0910-049-10R1 SD_DRILL_9.1MM_5XD_A	02897926	9,1 0.358	49,0 1.929	103,0 4.055	63,0 2.480	40,0 1.575	61,0 2.402	10,0 0.394	140°	TiAIN	IT9
SD1105A-0913-049-10R1 SD_DRILL_23/64_5XD_A	02897927	9,128 0.359	49,0 1.929	103,0 4.055	63,0 2.480	40,0 1.575	61,0 2.402	10,0 0.394	140°	TiAIN	IT9
SD1105A-0920-049-10R1 SD_DRILL_9.2MM_5XD_A	02897928	9,2 0.362	49,0 1.929	103,0 4.055	63,0 2.480	40,0 1.575	61,0 2.402	10,0 0.394	140°	TiAIN	IT9

Wstęp

Wiercenie

Rozwiercanie

Wyłaczanie

Załącznik

Oznaczenie	Numer produktu	DC	LU	OAL	LFS	LS	LCF	DMM	Kąt wierzchołkowy	Pokrycie	Tolerancja otworu
		mm Cal.	mm Cal.	mm Cal.	mm Cal.	mm Cal.	mm Cal.	mm Cal.	mm Cal.		
SD1105A-0930-049-10R1 SD_DRILL_9.3MM_5XD_A	02897929	9,3 0.366	49,0 1.929	103,0 4.055	63,0 2.480	40,0 1.575	61,0 2.402	10,0 0.394	140°	TiAIN	IT9
SD1105A-0940-049-10R1 SD_DRILL_9.4MM_5XD_A	02897930	9,4 0.370	49,0 1.929	103,0 4.055	63,0 2.480	40,0 1.575	61,0 2.402	10,0 0.394	140°	TiAIN	IT9
SD1105A-0950-049-10R1 SD_DRILL_9.5MM_5XD_A	02897931	9,5 0.374	49,0 1.929	103,0 4.055	63,0 2.480	40,0 1.575	61,0 2.402	10,0 0.394	140°	TiAIN	IT9
SD1105A-0953-049-10R1 SD_DRILL_3/8_5XD_A	02897932	9,525 0.375	49,0 1.929	103,0 4.055	63,0 2.480	40,0 1.575	61,0 2.402	10,0 0.394	140°	TiAIN	IT9
SD1105A-0955-049-10R1 SD_DRILL_9.55MM_5XD_A	02897933	9,55 0.376	49,0 1.929	103,0 4.055	63,0 2.480	40,0 1.575	61,0 2.402	10,0 0.394	140°	TiAIN	IT9
SD1105A-0960-049-10R1 SD_DRILL_9.6MM_5XD_A	02897934	9,6 0.378	49,0 1.929	103,0 4.055	63,0 2.480	40,0 1.575	61,0 2.402	10,0 0.394	140°	TiAIN	IT9
SD1105A-0970-049-10R1 SD_DRILL_9.7MM_5XD_A	02897935	9,7 0.382	49,0 1.929	103,0 4.055	63,0 2.480	40,0 1.575	61,0 2.402	10,0 0.394	140°	TiAIN	IT9
SD1105A-0980-049-10R1 SD_DRILL_9.8MM_5XD_A	02897936	9,8 0.386	49,0 1.929	103,0 4.055	63,0 2.480	40,0 1.575	61,0 2.402	10,0 0.394	140°	TiAIN	IT9
SD1105A-0990-049-10R1 SD_DRILL_9.9MM_5XD_A	02897937	9,9 0.390	49,0 1.929	103,0 4.055	63,0 2.480	40,0 1.575	61,0 2.402	10,0 0.394	140°	TiAIN	IT9
SD1105A-0992-049-10R1 SD_DRILL_25/64_5XD_A	02897938	9,922 0.391	49,0 1.929	103,0 4.055	63,0 2.480	40,0 1.575	61,0 2.402	10,0 0.394	140°	TiAIN	IT9
SD1105A-1000-049-10R1 SD_DRILL_10.0MM_5XD_A	02897939	10,0 0.394	49,0 1.929	103,0 4.055	63,0 2.480	40,0 1.575	61,0 2.402	10,0 0.394	140°	TiAIN	IT9
SD1105A-1010-056-12R1 SD_DRILL_10.1MM_5XD_A	02897940	10,1 0.398	56,0 2.205	118,0 4.646	73,0 2.874	45,0 1.772	71,0 2.795	12,0 0.472	140°	TiAIN	IT9
SD1105A-1020-056-12R1 SD_DRILL_10.2MM_5XD_A	02897941	10,2 0.402	56,0 2.205	118,0 4.646	73,0 2.874	45,0 1.772	71,0 2.795	12,0 0.472	140°	TiAIN	IT9
SD1105A-1030-056-12R1 SD_DRILL_10.3MM_5XD_A	02897942	10,3 0.406	56,0 2.205	118,0 4.646	73,0 2.874	45,0 1.772	71,0 2.795	12,0 0.472	140°	TiAIN	IT9
SD1105A-1032-056-12R1 SD_DRILL_13/32_5XD_A	02897943	10,319 0.406	56,0 2.205	118,0 4.646	73,0 2.874	45,0 1.772	71,0 2.795	12,0 0.472	140°	TiAIN	IT9
SD1105A-1040-056-12R1 SD_DRILL_10.4MM_5XD_A	02897944	10,4 0.409	56,0 2.205	118,0 4.646	73,0 2.874	45,0 1.772	71,0 2.795	12,0 0.472	140°	TiAIN	IT9
SD1105A-1050-056-12R1 SD_DRILL_10.5MM_5XD_A	02897945	10,5 0.413	56,0 2.205	118,0 4.646	73,0 2.874	45,0 1.772	71,0 2.795	12,0 0.472	140°	TiAIN	IT9
SD1105A-1060-056-12R1 SD_DRILL_10.6MM_5XD_A	02897946	10,6 0.417	56,0 2.205	118,0 4.646	73,0 2.874	45,0 1.772	71,0 2.795	12,0 0.472	140°	TiAIN	IT9
SD1105A-1070-056-12R1 SD_DRILL_10.7MM_5XD_A	02897947	10,7 0.421	56,0 2.205	118,0 4.646	73,0 2.874	45,0 1.772	71,0 2.795	12,0 0.472	140°	TiAIN	IT9
SD1105A-1072-056-12R1 SD_DRILL_27/64_5XD_A	02897948	10,716 0.422	56,0 2.205	118,0 4.646	73,0 2.874	45,0 1.772	71,0 2.795	12,0 0.472	140°	TiAIN	IT9
SD1105A-1080-056-12R1 SD_DRILL_10.8MM_5XD_A	02897949	10,8 0.425	56,0 2.205	118,0 4.646	73,0 2.874	45,0 1.772	71,0 2.795	12,0 0.472	140°	TiAIN	IT9
SD1105A-1090-056-12R1 SD_DRILL_10.9MM_5XD_A	02897951	10,9 0.429	56,0 2.205	118,0 4.646	73,0 2.874	45,0 1.772	71,0 2.795	12,0 0.472	140°	TiAIN	IT9
SD1105A-1100-056-12R1 SD_DRILL_11.0MM_5XD_A	02897952	11,0 0.433	56,0 2.205	118,0 4.646	73,0 2.874	45,0 1.772	71,0 2.795	12,0 0.472	140°	TiAIN	IT9
SD1105A-1110-056-12R1 SD_DRILL_11.1MM_5XD_A	02897953	11,1 0.437	56,0 2.205	118,0 4.646	73,0 2.874	45,0 1.772	71,0 2.795	12,0 0.472	140°	TiAIN	IT9
SD1105A-1111-056-12R1 SD_DRILL_7/16_5XD_A	02897954	11,113 0.438	56,0 2.205	118,0 4.646	73,0 2.874	45,0 1.772	71,0 2.795	12,0 0.472	140°	TiAIN	IT9
SD1105A-1120-056-12R1 SD_DRILL_11.2MM_5XD_A	02897955	11,2 0.441	56,0 2.205	118,0 4.646	73,0 2.874	45,0 1.772	71,0 2.795	12,0 0.472	140°	TiAIN	IT9
SD1105A-1130-056-12R1 SD_DRILL_11.3MM_5XD_A	02897956	11,3 0.445	56,0 2.205	118,0 4.646	73,0 2.874	45,0 1.772	71,0 2.795	12,0 0.472	140°	TiAIN	IT9
SD1105A-1140-056-12R1 SD_DRILL_11.4MM_5XD_A	02897957	11,4 0.449	56,0 2.205	118,0 4.646	73,0 2.874	45,0 1.772	71,0 2.795	12,0 0.472	140°	TiAIN	IT9
SD1105A-1150-056-12R1 SD_DRILL_11.5MM_5XD_A	02897958	11,5 0.453	56,0 2.205	118,0 4.646	73,0 2.874	45,0 1.772	71,0 2.795	12,0 0.472	140°	TiAIN	IT9
SD1105A-1151-056-12R1 SD_DRILL_29/64_5XD_A	02897959	11,509 0.453	56,0 2.205	118,0 4.646	73,0 2.874	45,0 1.772	71,0 2.795	12,0 0.472	140°	TiAIN	IT9
SD1105A-1155-056-12R1 SD_DRILL_11.55MM_5XD_A	02897960	11,55 0.455	56,0 2.205	118,0 4.646	73,0 2.874	45,0 1.772	71,0 2.795	12,0 0.472	140°	TiAIN	IT9

Oznaczenie	Numer produktu	DC	LU	OAL	LFS	LS	LCF	DMM	Kąt wierzchołkowy	Pokrycie	Tolerancja otworu
		mm <i>Cal.</i>	mm <i>Cal.</i>	mm <i>Cal.</i>	mm <i>Cal.</i>	mm <i>Cal.</i>	mm <i>Cal.</i>	mm <i>Cal.</i>			
SD1105A-1160-056-12R1 SD_DRILL_11.6MM_5XD_A	02897961	11,6 0.457	56,0 2.205	118,0 4.646	73,0 2.874	45,0 1.772	71,0 2.795	12,0 0.472	140°	TiAIN	IT9
SD1105A-1170-056-12R1 SD_DRILL_11.7MM_5XD_A	02897962	11,7 0.461	56,0 2.205	118,0 4.646	73,0 2.874	45,0 1.772	71,0 2.795	12,0 0.472	140°	TiAIN	IT9
SD1105A-1180-056-12R1 SD_DRILL_11.8MM_5XD_A	02897963	11,8 0.465	56,0 2.205	118,0 4.646	73,0 2.874	45,0 1.772	71,0 2.795	12,0 0.472	140°	TiAIN	IT9
SD1105A-1190-056-12R1 SD_DRILL_11.9MM_5XD_A	02897964	11,9 0.469	56,0 2.205	118,0 4.646	73,0 2.874	45,0 1.772	71,0 2.795	12,0 0.472	140°	TiAIN	IT9
SD1105A-1191-056-12R1 SD_DRILL_15/32_5XD_A	02897965	11,906 0.469	56,0 2.205	118,0 4.646	73,0 2.874	45,0 1.772	71,0 2.795	12,0 0.472	140°	TiAIN	IT9
SD1105A-1200-056-12R1 SD_DRILL_12.0MM_5XD_A	02897966	12,0 0.472	56,0 2.205	118,0 4.646	73,0 2.874	45,0 1.772	71,0 2.795	12,0 0.472	140°	TiAIN	IT9
SD1105A-1210-060-14R1 SD_DRILL_12.1MM_5XD_A	02897967	12,1 0.476	60,0 2.362	124,0 4.882	79,0 3.110	45,0 1.772	77,0 3.031	14,0 0.551	140°	TiAIN	IT9
SD1105A-1220-060-14R1 SD_DRILL_12.2MM_5XD_A	02897968	12,2 0.480	60,0 2.362	124,0 4.882	79,0 3.110	45,0 1.772	77,0 3.031	14,0 0.551	140°	TiAIN	IT9
SD1105A-1225-060-14R1 SD_DRILL_12.25MM_5XD_A	02897969	12,25 0.482	60,0 2.362	124,0 4.882	79,0 3.110	45,0 1.772	77,0 3.031	14,0 0.551	140°	TiAIN	IT9
SD1105A-1230-060-14R1 SD_DRILL_31/64_5XD_A	02897970	12,303 0.484	60,0 2.362	124,0 4.882	79,0 3.110	45,0 1.772	77,0 3.031	14,0 0.551	140°	TiAIN	IT9
SD1105A-1240-060-14R1 SD_DRILL_12.4MM_5XD_A	02897972	12,4 0.488	60,0 2.362	124,0 4.882	79,0 3.110	45,0 1.772	77,0 3.031	14,0 0.551	140°	TiAIN	IT9
SD1105A-1250-060-14R1 SD_DRILL_12.5MM_5XD_A	02897973	12,5 0.492	60,0 2.362	124,0 4.882	79,0 3.110	45,0 1.772	77,0 3.031	14,0 0.551	140°	TiAIN	IT9
SD1105A-1260-060-14R1 SD_DRILL_12.6MM_5XD_A	02897974	12,6 0.496	60,0 2.362	124,0 4.882	79,0 3.110	45,0 1.772	77,0 3.031	14,0 0.551	140°	TiAIN	IT9
SD1105A-1270-060-14R1 SD_DRILL_1/2_5XD_A	02897950	12,7 0.500	60,0 2.362	124,0 4.882	79,0 3.110	45,0 1.772	77,0 3.031	14,0 0.551	140°	TiAIN	IT9
SD1105A-1275-060-14R1 SD_DRILL_12.75MM_5XD_A	02897976	12,75 0.502	60,0 2.362	124,0 4.882	79,0 3.110	45,0 1.772	77,0 3.031	14,0 0.551	140°	TiAIN	IT9
SD1105A-1280-060-14R1 SD_DRILL_12.8MM_5XD_A	02897977	12,8 0.504	60,0 2.362	124,0 4.882	79,0 3.110	45,0 1.772	77,0 3.031	14,0 0.551	140°	TiAIN	IT9
SD1105A-1290-060-14R1 SD_DRILL_12.9MM_5XD_A	02897978	12,9 0.508	60,0 2.362	124,0 4.882	79,0 3.110	45,0 1.772	77,0 3.031	14,0 0.551	140°	TiAIN	IT9
SD1105A-1300-060-14R1 SD_DRILL_13.0MM_5XD_A	02897979	13,0 0.512	60,0 2.362	124,0 4.882	79,0 3.110	45,0 1.772	77,0 3.031	14,0 0.551	140°	TiAIN	IT9
SD1105A-1310-060-14R1 SD_DRILL_33/64_5XD_A	02897980	13,1 0.516	60,0 2.362	124,0 4.882	79,0 3.110	45,0 1.772	77,0 3.031	14,0 0.551	140°	TiAIN	IT9
SD1105A-1320-060-14R1 SD_DRILL_13.2MM_5XD_A	02897981	13,2 0.520	60,0 2.362	124,0 4.882	79,0 3.110	45,0 1.772	77,0 3.031	14,0 0.551	140°	TiAIN	IT9
SD1105A-1330-060-14R1 SD_DRILL_13.3MM_5XD_A	02897982	13,3 0.524	60,0 2.362	124,0 4.882	79,0 3.110	45,0 1.772	77,0 3.031	14,0 0.551	140°	TiAIN	IT9
SD1105A-1340-060-14R1 SD_DRILL_13.4MM_5XD_A	02897983	13,4 0.528	60,0 2.362	124,0 4.882	79,0 3.110	45,0 1.772	77,0 3.031	14,0 0.551	140°	TiAIN	IT9
SD1105A-1349-060-14R1 SD_DRILL_17/32_5XD_A	02897984	13,494 0.531	60,0 2.362	124,0 4.882	79,0 3.110	45,0 1.772	77,0 3.031	14,0 0.551	140°	TiAIN	IT9
SD1105A-1350-060-14R1 SD_DRILL_13.5MM_5XD_A	02897985	13,5 0.531	60,0 2.362	124,0 4.882	79,0 3.110	45,0 1.772	77,0 3.031	14,0 0.551	140°	TiAIN	IT9
SD1105A-1360-060-14R1 SD_DRILL_13.6MM_5XD_A	02897986	13,6 0.535	60,0 2.362	124,0 4.882	79,0 3.110	45,0 1.772	77,0 3.031	14,0 0.551	140°	TiAIN	IT9
SD1105A-1370-060-14R1 SD_DRILL_13.7MM_5XD_A	02897987	13,7 0.539	60,0 2.362	124,0 4.882	79,0 3.110	45,0 1.772	77,0 3.031	14,0 0.551	140°	TiAIN	IT9
SD1105A-1380-060-14R1 SD_DRILL_13.8MM_5XD_A	02897988	13,8 0.543	60,0 2.362	124,0 4.882	79,0 3.110	45,0 1.772	77,0 3.031	14,0 0.551	140°	TiAIN	IT9
SD1105A-1390-060-14R1 SD_DRILL_35/64_5XD_A	02897989	13,9 0.547	60,0 2.362	124,0 4.882	79,0 3.110	45,0 1.772	77,0 3.031	14,0 0.551	140°	TiAIN	IT9
SD1105A-1400-060-14R1 SD_DRILL_14.0MM_5XD_A	02897990	14,0 0.551	60,0 2.362	124,0 4.882	79,0 3.110	45,0 1.772	77,0 3.031	14,0 0.551	140°	TiAIN	IT9
SD1105A-1410-063-16R1 SD_DRILL_14.1MM_5XD_A	02897991	14,1 0.555	63,0 2.480	133,0 5.236	85,0 3.346	48,0 1.890	83,0 3.268	16,0 0.630	140°	TiAIN	IT9
SD1105A-1420-063-16R1 SD_DRILL_14.2MM_5XD_A	02897992	14,2 0.559	63,0 2.480	133,0 5.236	85,0 3.346	48,0 1.890	83,0 3.268	16,0 0.630	140°	TiAIN	IT9

Wstęp

Wiercenie

Rozwiercanie

Wyłaczanie

Załącznik

Oznaczenie	Numer produktu	DC	LU	OAL	LFS	LS	LCF	DMM	Kąt wierzchołkowy	Pokrycie	Tolerancja otworu
		mm Cal.	mm Cal.	mm Cal.	mm Cal.	mm Cal.	mm Cal.	mm Cal.			
SD1105A-1429-063-16R1 SD_DRILL_9/16_5XD_A	02897993	14,288 0.563	63,0 2.480	133,0 5.236	85,0 3.346	48,0 1.890	83,0 3.268	16,0 0.630	140°	TiAIN	IT9
SD1105A-1430-063-16R1 SD_DRILL_14.3MM_5XD_A	02897994	14,3 0.563	63,0 2.480	133,0 5.236	85,0 3.346	48,0 1.890	83,0 3.268	16,0 0.630	140°	TiAIN	IT9
SD1105A-1440-063-16R1 SD_DRILL_14.4MM_5XD_A	02897995	14,4 0.567	63,0 2.480	133,0 5.236	85,0 3.346	48,0 1.890	83,0 3.268	16,0 0.630	140°	TiAIN	IT9
SD1105A-1450-063-16R1 SD_DRILL_14.5MM_5XD_A	02897996	14,5 0.571	63,0 2.480	133,0 5.236	85,0 3.346	48,0 1.890	83,0 3.268	16,0 0.630	140°	TiAIN	IT9
SD1105A-1460-063-16R1 SD_DRILL_14.6MM_5XD_A	02897997	14,6 0.575	63,0 2.480	133,0 5.236	85,0 3.346	48,0 1.890	83,0 3.268	16,0 0.630	140°	TiAIN	IT9
SD1105A-1470-063-16R1 SD_DRILL_14.7MM_5XD_A	02897998	14,7 0.579	63,0 2.480	133,0 5.236	85,0 3.346	48,0 1.890	83,0 3.268	16,0 0.630	140°	TiAIN	IT9
SD1105A-1475-063-16R1 SD_DRILL_14.75MM_5XD_A	02897999	14,75 0.581	63,0 2.480	133,0 5.236	85,0 3.346	48,0 1.890	83,0 3.268	16,0 0.630	140°	TiAIN	IT9
SD1105A-1480-063-16R1 SD_DRILL_14.8MM_5XD_A	02898000	14,8 0.583	63,0 2.480	133,0 5.236	85,0 3.346	48,0 1.890	83,0 3.268	16,0 0.630	140°	TiAIN	IT9
SD1105A-1490-063-16R1 SD_DRILL_14.9MM_5XD_A	02898001	14,9 0.587	63,0 2.480	133,0 5.236	85,0 3.346	48,0 1.890	83,0 3.268	16,0 0.630	140°	TiAIN	IT9
SD1105A-1500-063-16R1 SD_DRILL_15.0MM_5XD_A	02898002	15,0 0.591	63,0 2.480	133,0 5.236	85,0 3.346	48,0 1.890	83,0 3.268	16,0 0.630	140°	TiAIN	IT9
SD1105A-1510-063-16R1 SD_DRILL_15.1MM_5XD_A	02898003	15,1 0.594	63,0 2.480	133,0 5.236	85,0 3.346	48,0 1.890	83,0 3.268	16,0 0.630	140°	TiAIN	IT9
SD1105A-1520-063-16R1 SD_DRILL_15.2MM_5XD_A	02898004	15,2 0.598	63,0 2.480	133,0 5.236	85,0 3.346	48,0 1.890	83,0 3.268	16,0 0.630	140°	TiAIN	IT9
SD1105A-1530-063-16R1 SD_DRILL_15.3MM_5XD_A	02898005	15,3 0.602	63,0 2.480	133,0 5.236	85,0 3.346	48,0 1.890	83,0 3.268	16,0 0.630	140°	TiAIN	IT9
SD1105A-1540-063-16R1 SD_DRILL_15.4MM_5XD_A	02898006	15,4 0.606	63,0 2.480	133,0 5.236	85,0 3.346	48,0 1.890	83,0 3.268	16,0 0.630	140°	TiAIN	IT9
SD1105A-1550-063-16R1 SD_DRILL_15.5MM_5XD_A	02898007	15,5 0.610	63,0 2.480	133,0 5.236	85,0 3.346	48,0 1.890	83,0 3.268	16,0 0.630	140°	TiAIN	IT9
SD1105A-1560-063-16R1 SD_DRILL_15.6MM_5XD_A	02898008	15,6 0.614	63,0 2.480	133,0 5.236	85,0 3.346	48,0 1.890	83,0 3.268	16,0 0.630	140°	TiAIN	IT9
SD1105A-1570-063-16R1 SD_DRILL_15.7MM_5XD_A	02898009	15,7 0.618	63,0 2.480	133,0 5.236	85,0 3.346	48,0 1.890	83,0 3.268	16,0 0.630	140°	TiAIN	IT9
SD1105A-1580-063-16R1 SD_DRILL_15.8MM_5XD_A	02898010	15,8 0.622	63,0 2.480	133,0 5.236	85,0 3.346	48,0 1.890	83,0 3.268	16,0 0.630	140°	TiAIN	IT9
SD1105A-1588-063-16R1 SD_DRILL_5/8_5XD_A	02898011	15,875 0.625	63,0 2.480	133,0 5.236	85,0 3.346	48,0 1.890	83,0 3.268	16,0 0.630	140°	TiAIN	IT9
SD1105A-1590-063-16R1 SD_DRILL_15.9MM_5XD_A	02898012	15,9 0.626	63,0 2.480	133,0 5.236	85,0 3.346	48,0 1.890	83,0 3.268	16,0 0.630	140°	TiAIN	IT9
SD1105A-1600-063-16R1 SD_DRILL_16.0MM_5XD_A	02898013	16,0 0.630	63,0 2.480	133,0 5.236	85,0 3.346	48,0 1.890	83,0 3.268	16,0 0.630	140°	TiAIN	IT9
SD1105A-1610-071-18R1 SD_DRILL_16.1MM_5XD_A	02898014	16,1 0.634	71,0 2.795	143,0 5.630	95,0 3.740	48,0 1.890	93,0 3.661	18,0 0.709	140°	TiAIN	IT9
SD1105A-1620-071-18R1 SD_DRILL_16.2MM_5XD_A	02898015	16,2 0.638	71,0 2.795	143,0 5.630	95,0 3.740	48,0 1.890	93,0 3.661	18,0 0.709	140°	TiAIN	IT9
SD1105A-1630-071-18R1 SD_DRILL_16.3MM_5XD_A	02898016	16,3 0.642	71,0 2.795	143,0 5.630	95,0 3.740	48,0 1.890	93,0 3.661	18,0 0.709	140°	TiAIN	IT9
SD1105A-1640-071-18R1 SD_DRILL_16.4MM_5XD_A	02898017	16,4 0.646	71,0 2.795	143,0 5.630	95,0 3.740	48,0 1.890	93,0 3.661	18,0 0.709	140°	TiAIN	IT9
SD1105A-1650-071-18R1 SD_DRILL_16.5MM_5XD_A	02898018	16,5 0.650	71,0 2.795	143,0 5.630	95,0 3.740	48,0 1.890	93,0 3.661	18,0 0.709	140°	TiAIN	IT9
SD1105A-1660-071-18R1 SD_DRILL_16.6MM_5XD_A	02898019	16,6 0.654	71,0 2.795	143,0 5.630	95,0 3.740	48,0 1.890	93,0 3.661	18,0 0.709	140°	TiAIN	IT9
SD1105A-1670-071-18R1 SD_DRILL_16.7MM_5XD_A	02898020	16,7 0.657	71,0 2.795	143,0 5.630	95,0 3.740	48,0 1.890	93,0 3.661	18,0 0.709	140°	TiAIN	IT9
SD1105A-1675-071-18R1 SD_DRILL_16.75MM_5XD_A	02898021	16,75 0.659	71,0 2.795	143,0 5.630	95,0 3.740	48,0 1.890	93,0 3.661	18,0 0.709	140°	TiAIN	IT9
SD1105A-1680-071-18R1 SD_DRILL_16.8MM_5XD_A	02898022	16,8 0.661	71,0 2.795	143,0 5.630	95,0 3.740	48,0 1.890	93,0 3.661	18,0 0.709	140°	TiAIN	IT9
SD1105A-1690-071-18R1 SD_DRILL_16.9MM_5XD_A	02898023	16,9 0.665	71,0 2.795	143,0 5.630	95,0 3.740	48,0 1.890	93,0 3.661	18,0 0.709	140°	TiAIN	IT9

Oznaczenie	Numer produktu	DC	LU	OAL	LFS	LS	LCF	DMM	Kąt wierzchołkowy	Pokrycie	Tolerancja otworu
		mm Cal.	mm Cal.	mm Cal.	mm Cal.	mm Cal.	mm Cal.	mm Cal.			
SD1105A-1700-071-18R1 SD_DRILL_17.0MM_5XD_A	02898024	17,0 0.669	71,0 2.795	143,0 5.630	95,0 3.740	48,0 1.890	93,0 3.661	18,0 0.709	140°	TiAIN	IT9
SD1105A-1710-071-18R1 SD_DRILL_17.1MM_5XD_A	02898025	17,1 0.673	71,0 2.795	143,0 5.630	95,0 3.740	48,0 1.890	93,0 3.661	18,0 0.709	140°	TiAIN	IT9
SD1105A-1720-071-18R1 SD_DRILL_17.2MM_5XD_A	02898026	17,2 0.677	71,0 2.795	143,0 5.630	95,0 3.740	48,0 1.890	93,0 3.661	18,0 0.709	140°	TiAIN	IT9
SD1105A-1730-071-18R1 SD_DRILL_17.3MM_5XD_A	02898027	17,3 0.681	71,0 2.795	143,0 5.630	95,0 3.740	48,0 1.890	93,0 3.661	18,0 0.709	140°	TiAIN	IT9
SD1105A-1740-071-18R1 SD_DRILL_17.4MM_5XD_A	02898028	17,4 0.685	71,0 2.795	143,0 5.630	95,0 3.740	48,0 1.890	93,0 3.661	18,0 0.709	140°	TiAIN	IT9
SD1105A-1750-071-18R1 SD_DRILL_17.5MM_5XD_A	02898029	17,5 0.689	71,0 2.795	143,0 5.630	95,0 3.740	48,0 1.890	93,0 3.661	18,0 0.709	140°	TiAIN	IT9
SD1105A-1760-071-18R1 SD_DRILL_17.6MM_5XD_A	02898030	17,6 0.693	71,0 2.795	143,0 5.630	95,0 3.740	48,0 1.890	93,0 3.661	18,0 0.709	140°	TiAIN	IT9
SD1105A-1770-071-18R1 SD_DRILL_17.7MM_5XD_A	02898031	17,7 0.697	71,0 2.795	143,0 5.630	95,0 3.740	48,0 1.890	93,0 3.661	18,0 0.709	140°	TiAIN	IT9
SD1105A-1780-071-18R1 SD_DRILL_17.8MM_5XD_A	02898032	17,8 0.701	71,0 2.795	143,0 5.630	95,0 3.740	48,0 1.890	93,0 3.661	18,0 0.709	140°	TiAIN	IT9
SD1105A-1790-071-18R1 SD_DRILL_17.9MM_5XD_A	02898033	17,9 0.705	71,0 2.795	143,0 5.630	95,0 3.740	48,0 1.890	93,0 3.661	18,0 0.709	140°	TiAIN	IT9
SD1105A-1800-071-18R1 SD_DRILL_18.0MM_5XD_A	02898034	18,0 0.709	71,0 2.795	143,0 5.630	95,0 3.740	48,0 1.890	93,0 3.661	18,0 0.709	140°	TiAIN	IT9
SD1105A-1810-077-20R1 SD_DRILL_18.1MM_5XD_A	02898035	18,1 0.713	77,0 3.031	153,0 6.024	103,0 4.055	50,0 1.969	101,0 3.976	20,0 0.787	140°	TiAIN	IT9
SD1105A-1820-077-20R1 SD_DRILL_18.2MM_5XD_A	02898036	18,2 0.717	77,0 3.031	153,0 6.024	103,0 4.055	50,0 1.969	101,0 3.976	20,0 0.787	140°	TiAIN	IT9
SD1105A-1830-077-20R1 SD_DRILL_18.3MM_5XD_A	02898037	18,3 0.720	77,0 3.031	153,0 6.024	103,0 4.055	50,0 1.969	101,0 3.976	20,0 0.787	140°	TiAIN	IT9
SD1105A-1840-077-20R1 SD_DRILL_18.4MM_5XD_A	02898038	18,4 0.724	77,0 3.031	153,0 6.024	103,0 4.055	50,0 1.969	101,0 3.976	20,0 0.787	140°	TiAIN	IT9
SD1105A-1850-077-20R1 SD_DRILL_18.5MM_5XD_A	02898039	18,5 0.728	77,0 3.031	153,0 6.024	103,0 4.055	50,0 1.969	101,0 3.976	20,0 0.787	140°	TiAIN	IT9
SD1105A-1860-077-20R1 SD_DRILL_18.6MM_5XD_A	02898040	18,6 0.732	77,0 3.031	153,0 6.024	103,0 4.055	50,0 1.969	101,0 3.976	20,0 0.787	140°	TiAIN	IT9
SD1105A-1870-077-20R1 SD_DRILL_18.7MM_5XD_A	02898041	18,7 0.736	77,0 3.031	153,0 6.024	103,0 4.055	50,0 1.969	101,0 3.976	20,0 0.787	140°	TiAIN	IT9
SD1105A-1880-077-20R1 SD_DRILL_18.8MM_5XD_A	02898042	18,8 0.740	77,0 3.031	153,0 6.024	103,0 4.055	50,0 1.969	101,0 3.976	20,0 0.787	140°	TiAIN	IT9
SD1105A-1890-077-20R1 SD_DRILL_18.9MM_5XD_A	02898043	18,9 0.744	77,0 3.031	153,0 6.024	103,0 4.055	50,0 1.969	101,0 3.976	20,0 0.787	140°	TiAIN	IT9
SD1105A-1900-077-20R1 SD_DRILL_19.0MM_5XD_A	02898044	19,0 0.748	77,0 3.031	153,0 6.024	103,0 4.055	50,0 1.969	101,0 3.976	20,0 0.787	140°	TiAIN	IT9
SD1105A-1905-077-20R1 SD_DRILL_3/4_5XD_A	02898045	19,05 0.750	77,0 3.031	153,0 6.024	103,0 4.055	50,0 1.969	101,0 3.976	20,0 0.787	140°	TiAIN	IT9
SD1105A-1910-077-20R1 SD_DRILL_19.1MM_5XD_A	02898046	19,1 0.752	77,0 3.031	153,0 6.024	103,0 4.055	50,0 1.969	101,0 3.976	20,0 0.787	140°	TiAIN	IT9
SD1105A-1920-077-20R1 SD_DRILL_19.2MM_5XD_A	02898047	19,2 0.756	77,0 3.031	153,0 6.024	103,0 4.055	50,0 1.969	101,0 3.976	20,0 0.787	140°	TiAIN	IT9
SD1105A-1930-077-20R1 SD_DRILL_19.3MM_5XD_A	02898048	19,3 0.760	77,0 3.031	153,0 6.024	103,0 4.055	50,0 1.969	101,0 3.976	20,0 0.787	140°	TiAIN	IT9
SD1105A-1940-077-20R1 SD_DRILL_19.4MM_5XD_A	02898049	19,4 0.764	77,0 3.031	153,0 6.024	103,0 4.055	50,0 1.969	101,0 3.976	20,0 0.787	140°	TiAIN	IT9
SD1105A-1950-077-20R1 SD_DRILL_19.5MM_5XD_A	02898050	19,5 0.768	77,0 3.031	153,0 6.024	103,0 4.055	50,0 1.969	101,0 3.976	20,0 0.787	140°	TiAIN	IT9
SD1105A-1960-077-20R1 SD_DRILL_19.6MM_5XD_A	02898051	19,6 0.772	77,0 3.031	153,0 6.024	103,0 4.055	50,0 1.969	101,0 3.976	20,0 0.787	140°	TiAIN	IT9
SD1105A-1970-077-20R1 SD_DRILL_19.7MM_5XD_A	02898052	19,7 0.776	77,0 3.031	153,0 6.024	103,0 4.055	50,0 1.969	101,0 3.976	20,0 0.787	140°	TiAIN	IT9
SD1105A-1980-077-20R1 SD_DRILL_19.8MM_5XD_A	02898053	19,8 0.780	77,0 3.031	153,0 6.024	103,0 4.055	50,0 1.969	101,0 3.976	20,0 0.787	140°	TiAIN	IT9

Oznaczenie	Numer produktu	DC	LU	OAL	LFS	LS	LCF	DMM	Kąt wierzchołkowy	Pokrycie	Tolerancja otworu
		mm <i>Cal.</i>	mm <i>Cal.</i>	mm <i>Cal.</i>	mm <i>Cal.</i>	mm <i>Cal.</i>	mm <i>Cal.</i>	mm <i>Cal.</i>			
SD1105A-1990-077-20R1 SD_DRILL_19.9MM_5XD_A	02898054	19,9 0.783	77,0 3.031	153,0 6.024	103,0 4.055	50,0 1.969	101,0 3.976	20,0 0.787	140°	TiAlN	IT9
SD1105A-2000-077-20R1 SD_DRILL_20.0MM_5XD_A	02898055	20,0 0.787	77,0 3.031	153,0 6.024	103,0 4.055	50,0 1.969	101,0 3.976	20,0 0.787	140°	TiAlN	IT9

Wstęp

Wiercenie

Rozwiercanie

Wyłaczanie

Załącznik

SD1108A

Głębokość wiercenia ~ 8 x D – Metryczne/Calowe

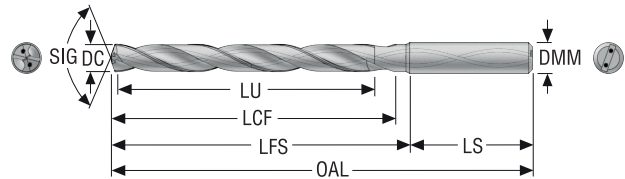

- Chwył cylindryczny DIN 6537A
- Tolerancja DC m7
- Chłodzenie wewnętrzne
- Parametry skrawania, patrz strona (strony) 142
- Średnice pośrednie patrz aplikacja MyDesign.

Oznaczenie	Numer produktu	DC	LU	OAL	LFS	LS	LCF	DMM	Kąt wierzchołkowy	Pokrycie	Tolerancja otworu
		mm Cal.	mm Cal.	mm Cal.	mm Cal.	mm Cal.	mm Cal.	mm Cal.			
SD1108A-0300-028-06R1 SD_DRILL_3.0MM_8XD_A	03295178	3,0 0.118	28,0 1.102	74,0 2.913	38,0 1.496	36,0 1.417	34,0 1.339	6,0 0.236	140°	TiAIN	IT9
SD1108A-0310-028-06R1 SD_DRILL_3.1MM_8XD_A	03295179	3,1 0.122	28,0 1.102	74,0 2.913	38,0 1.496	36,0 1.417	34,0 1.339	6,0 0.236	140°	TiAIN	IT9
SD1108A-0318-028-06R1 SD_DRILL_1/8_8XD_A	03323680	3,175 0.125	28,0 1.102	74,0 2.913	38,0 1.496	36,0 1.417	34,0 1.339	6,0 0.236	140°	TiAIN	IT9
SD1108A-0320-028-06R1 SD_DRILL_3.2MM_8XD_A	03295180	3,2 0.126	28,0 1.102	74,0 2.913	38,0 1.496	36,0 1.417	34,0 1.339	6,0 0.236	140°	TiAIN	IT9
SD1108A-0330-028-06R1 SD_DRILL_3.3MM_8XD_A	03295181	3,3 0.130	28,0 1.102	74,0 2.913	38,0 1.496	36,0 1.417	34,0 1.339	6,0 0.236	140°	TiAIN	IT9
SD1108A-0340-028-06R1 SD_DRILL_3.4MM_8XD_A	03295182	3,4 0.134	28,0 1.102	74,0 2.913	38,0 1.496	36,0 1.417	34,0 1.339	6,0 0.236	140°	TiAIN	IT9
SD1108A-0350-028-06R1 SD_DRILL_3.5MM_8XD_A	03295183	3,5 0.138	28,0 1.102	74,0 2.913	38,0 1.496	36,0 1.417	34,0 1.339	6,0 0.236	140°	TiAIN	IT9
SD1108A-0357-028-06R1 SD_DRILL_9/64_8XD_A	03323681	3,572 0.141	28,0 1.102	74,0 2.913	38,0 1.496	36,0 1.417	34,0 1.339	6,0 0.236	140°	TiAIN	IT9
SD1108A-0360-028-06R1 SD_DRILL_3.6MM_8XD_A	03295184	3,6 0.142	28,0 1.102	74,0 2.913	38,0 1.496	36,0 1.417	34,0 1.339	6,0 0.236	140°	TiAIN	IT9
SD1108A-0370-028-06R1 SD_DRILL_3.7MM_8XD_A	03295185	3,7 0.146	28,0 1.102	74,0 2.913	38,0 1.496	36,0 1.417	34,0 1.339	6,0 0.236	140°	TiAIN	IT9
SD1108A-0380-037-06R1 SD_DRILL_3.8MM_8XD_A	03295186	3,8 0.150	37,0 1.457	85,0 3.346	49,0 1.929	36,0 1.417	45,0 1.772	6,0 0.236	140°	TiAIN	IT9
SD1108A-0390-037-06R1 SD_DRILL_3.9MM_8XD_A	03295187	3,9 0.154	37,0 1.457	85,0 3.346	49,0 1.929	36,0 1.417	45,0 1.772	6,0 0.236	140°	TiAIN	IT9
SD1108A-0397-037-06R1 SD_DRILL_5/32_8XD_A	03323682	3,969 0.156	37,0 1.457	85,0 3.346	49,0 1.929	36,0 1.417	45,0 1.772	6,0 0.236	140°	TiAIN	IT9
SD1108A-0400-037-06R1 SD_DRILL_4.0MM_8XD_A	03295188	4,0 0.157	37,0 1.457	85,0 3.346	49,0 1.929	36,0 1.417	45,0 1.772	6,0 0.236	140°	TiAIN	IT9
SD1108A-0410-037-06R1 SD_DRILL_4.1MM_8XD_A	03295189	4,1 0.161	37,0 1.457	85,0 3.346	49,0 1.929	36,0 1.417	45,0 1.772	6,0 0.236	140°	TiAIN	IT9
SD1108A-0420-037-06R1 SD_DRILL_4.2MM_8XD_A	03295190	4,2 0.165	37,0 1.457	85,0 3.346	49,0 1.929	36,0 1.417	45,0 1.772	6,0 0.236	140°	TiAIN	IT9
SD1108A-0430-037-06R1 SD_DRILL_4.3MM_8XD_A	03295191	4,3 0.169	37,0 1.457	85,0 3.346	49,0 1.929	36,0 1.417	45,0 1.772	6,0 0.236	140°	TiAIN	IT9
SD1108A-0437-037-06R1 SD_DRILL_11/64_8XD_A	03323683	4,366 0.172	37,0 1.457	85,0 3.346	49,0 1.929	36,0 1.417	45,0 1.772	6,0 0.236	140°	TiAIN	IT9
SD1108A-0440-037-06R1 SD_DRILL_4.4MM_8XD_A	03295192	4,4 0.173	37,0 1.457	85,0 3.346	49,0 1.929	36,0 1.417	45,0 1.772	6,0 0.236	140°	TiAIN	IT9
SD1108A-0450-037-06R1 SD_DRILL_4.5MM_8XD_A	03295193	4,5 0.177	37,0 1.457	85,0 3.346	49,0 1.929	36,0 1.417	45,0 1.772	6,0 0.236	140°	TiAIN	IT9
SD1108A-0460-037-06R1 SD_DRILL_4.6MM_8XD_A	03295194	4,6 0.181	37,0 1.457	85,0 3.346	49,0 1.929	36,0 1.417	45,0 1.772	6,0 0.236	140°	TiAIN	IT9

Wstęp

Wiercenie

Rozwiercanie

Wyłaczanie

Załącznik

Oznaczenie	Numer produktu	DC	LU	OAL	LFS	LS	LCF	DMM	Kąt wierzchołkowy	Pokrycie	Tolerancja otworu
		mm Cal.	mm Cal.	mm Cal.	mm Cal.	mm Cal.	mm Cal.	mm Cal.			
SD1108A-0470-037-06R1 SD_DRILL_4.7MM_8XD_A	03295195	4,7 0.185	37,0 1.457	85,0 3.346	49,0 1.929	36,0 1.417	45,0 1.772	6,0 0.236	140°	TiAlN	IT9
SD1108A-0476-048-06R1 SD_DRILL_3/16_8XD_A	03323684	4,763 0.188	48,0 1.890	97,0 3.819	61,0 2.402	36,0 1.417	57,0 2.244	6,0 0.236	140°	TiAlN	IT9
SD1108A-0480-048-06R1 SD_DRILL_4.8MM_8XD_A	03295197	4,8 0.189	48,0 1.890	97,0 3.819	61,0 2.402	36,0 1.417	57,0 2.244	6,0 0.236	140°	TiAlN	IT9
SD1108A-0490-048-06R1 SD_DRILL_4.9MM_8XD_A	03295198	4,9 0.193	48,0 1.890	97,0 3.819	61,0 2.402	36,0 1.417	57,0 2.244	6,0 0.236	140°	TiAlN	IT9
SD1108A-0500-048-06R1 SD_DRILL_5.0MM_8XD_A	03295199	5,0 0.197	48,0 1.890	97,0 3.819	61,0 2.402	36,0 1.417	57,0 2.244	6,0 0.236	140°	TiAlN	IT9
SD1108A-0510-048-06R1 SD_DRILL_5.1MM_8XD_A	03295200	5,1 0.201	48,0 1.890	97,0 3.819	61,0 2.402	36,0 1.417	57,0 2.244	6,0 0.236	140°	TiAlN	IT9
SD1108A-0516-048-06R1 SD_DRILL_13/64_8XD_A	03323685	5,159 0.203	48,0 1.890	97,0 3.819	61,0 2.402	36,0 1.417	57,0 2.244	6,0 0.236	140°	TiAlN	IT9
SD1108A-0520-048-06R1 SD_DRILL_5.2MM_8XD_A	03295201	5,2 0.205	48,0 1.890	97,0 3.819	61,0 2.402	36,0 1.417	57,0 2.244	6,0 0.236	140°	TiAlN	IT9
SD1108A-0530-048-06R1 SD_DRILL_5.3MM_8XD_A	03295202	5,3 0.209	48,0 1.890	97,0 3.819	61,0 2.402	36,0 1.417	57,0 2.244	6,0 0.236	140°	TiAlN	IT9
SD1108A-0540-048-06R1 SD_DRILL_5.4MM_8XD_A	03295203	5,4 0.213	48,0 1.890	97,0 3.819	61,0 2.402	36,0 1.417	57,0 2.244	6,0 0.236	140°	TiAlN	IT9
SD1108A-0550-048-06R1 SD_DRILL_5.5MM_8XD_A	03295204	5,5 0.217	48,0 1.890	97,0 3.819	61,0 2.402	36,0 1.417	57,0 2.244	6,0 0.236	140°	TiAlN	IT9
SD1108A-0556-048-06R1 SD_DRILL_7/32_8XD_A	03295206	5,556 0.219	48,0 1.890	97,0 3.819	61,0 2.402	36,0 1.417	57,0 2.244	6,0 0.236	140°	TiAlN	IT9
SD1108A-0560-048-06R1 SD_DRILL_5.6MM_8XD_A	03295207	5,6 0.220	48,0 1.890	97,0 3.819	61,0 2.402	36,0 1.417	57,0 2.244	6,0 0.236	140°	TiAlN	IT9
SD1108A-0570-048-06R1 SD_DRILL_5.7MM_8XD_A	03295208	5,7 0.224	48,0 1.890	97,0 3.819	61,0 2.402	36,0 1.417	57,0 2.244	6,0 0.236	140°	TiAlN	IT9
SD1108A-0580-048-06R1 SD_DRILL_5.8MM_8XD_A	03295012	5,8 0.228	48,0 1.890	97,0 3.819	61,0 2.402	36,0 1.417	57,0 2.244	6,0 0.236	140°	TiAlN	IT9
SD1108A-0590-048-06R1 SD_DRILL_5.9MM_8XD_A	03295013	5,9 0.232	48,0 1.890	97,0 3.819	61,0 2.402	36,0 1.417	57,0 2.244	6,0 0.236	140°	TiAlN	IT9
SD1108A-0595-048-06R1 SD_DRILL_15/64_8XD_A	03323686	5,953 0.234	48,0 1.890	97,0 3.819	61,0 2.402	36,0 1.417	57,0 2.244	6,0 0.236	140°	TiAlN	IT9
SD1108A-0600-048-06R1 SD_DRILL_6.0MM_8XD_A	03295014	6,0 0.236	48,0 1.890	97,0 3.819	61,0 2.402	36,0 1.417	57,0 2.244	6,0 0.236	140°	TiAlN	IT9
SD1108A-0610-055-08R1 SD_DRILL_6.1MM_8XD_A	03295015	6,1 0.240	55,0 2.165	106,0 4.173	70,0 2.756	36,0 1.417	66,0 2.598	8,0 0.315	140°	TiAlN	IT9
SD1108A-0620-055-08R1 SD_DRILL_6.2MM_8XD_A	03295016	6,2 0.244	55,0 2.165	106,0 4.173	70,0 2.756	36,0 1.417	66,0 2.598	8,0 0.315	140°	TiAlN	IT9
SD1108A-0630-055-08R1 SD_DRILL_6.3MM_8XD_A	03295017	6,3 0.248	55,0 2.165	106,0 4.173	70,0 2.756	36,0 1.417	66,0 2.598	8,0 0.315	140°	TiAlN	IT9
SD1108A-0635-055-08R1 SD_DRILL_1/4_8XD_A	03295018	6,35 0.250	55,0 2.165	106,0 4.173	70,0 2.756	36,0 1.417	66,0 2.598	8,0 0.315	140°	TiAlN	IT9
SD1108A-0640-055-08R1 SD_DRILL_6.4MM_8XD_A	03295019	6,4 0.252	55,0 2.165	106,0 4.173	70,0 2.756	36,0 1.417	66,0 2.598	8,0 0.315	140°	TiAlN	IT9
SD1108A-0650-055-08R1 SD_DRILL_6.5MM_8XD_A	03295020	6,5 0.256	55,0 2.165	106,0 4.173	70,0 2.756	36,0 1.417	66,0 2.598	8,0 0.315	140°	TiAlN	IT9
SD1108A-0660-055-08R1 SD_DRILL_6.6MM_8XD_A	03295021	6,6 0.260	55,0 2.165	106,0 4.173	70,0 2.756	36,0 1.417	66,0 2.598	8,0 0.315	140°	TiAlN	IT9
SD1108A-0670-055-08R1 SD_DRILL_6.7MM_8XD_A	03295022	6,7 0.264	55,0 2.165	106,0 4.173	70,0 2.756	36,0 1.417	66,0 2.598	8,0 0.315	140°	TiAlN	IT9
SD1108A-0675-055-08R1 SD_DRILL_17/64_8XD_A	03323687	6,747 0.266	55,0 2.165	106,0 4.173	70,0 2.756	36,0 1.417	66,0 2.598	8,0 0.315	140°	TiAlN	IT9
SD1108A-0680-055-08R1 SD_DRILL_6.8MM_8XD_A	03295023	6,8 0.268	55,0 2.165	106,0 4.173	70,0 2.756	36,0 1.417	66,0 2.598	8,0 0.315	140°	TiAlN	IT9
SD1108A-0690-055-08R1 SD_DRILL_6.9MM_8XD_A	03295024	6,9 0.272	55,0 2.165	106,0 4.173	70,0 2.756	36,0 1.417	66,0 2.598	8,0 0.315	140°	TiAlN	IT9
SD1108A-0700-055-08R1 SD_DRILL_7.0MM_8XD_A	03295025	7,0 0.276	55,0 2.165	106,0 4.173	70,0 2.756	36,0 1.417	66,0 2.598	8,0 0.315	140°	TiAlN	IT9
SD1108A-0710-064-08R1 SD_DRILL_7.1MM_8XD_A	03295026	7,1 0.280	64,0 2.520	116,0 4.567	80,0 3.150	36,0 1.417	76,0 2.992	8,0 0.315	140°	TiAlN	IT9

Oznaczenie	Numer produktu	DC	LU	OAL	LFS	LS	LCF	DMM	Kąt wierzchołkowy	Pokrycie	Tolerancja otworu
		mm Cal.	mm Cal.	mm Cal.	mm Cal.	mm Cal.	mm Cal.	mm Cal.			
SD1108A-0714-064-08R1 SD_DRILL_9/32_8XD_A	03323688	7,144 0.281	64,0 2.520	116,0 4.567	80,0 3.150	36,0 1.417	76,0 2.992	8,0 0.315	140°	TiAIN	IT9
SD1108A-0730-064-08R1 SD_DRILL_7.3MM_8XD_A	03323689	7,3 0.287	64,0 2.520	116,0 4.567	80,0 3.150	36,0 1.417	76,0 2.992	8,0 0.315	140°	TiAIN	IT9
SD1108A-0740-064-08R1 SD_DRILL_7.4MM_8XD_A	03295027	7,4 0.291	64,0 2.520	116,0 4.567	80,0 3.150	36,0 1.417	76,0 2.992	8,0 0.315	140°	TiAIN	IT9
SD1108A-0750-064-08R1 SD_DRILL_7.5MM_8XD_A	03295028	7,5 0.295	64,0 2.520	116,0 4.567	80,0 3.150	36,0 1.417	76,0 2.992	8,0 0.315	140°	TiAIN	IT9
SD1108A-0754-064-08R1 SD_DRILL_19/64_8XD_A	03323690	7,541 0.297	64,0 2.520	116,0 4.567	80,0 3.150	36,0 1.417	76,0 2.992	8,0 0.315	140°	TiAIN	IT9
SD1108A-0760-064-08R1 SD_DRILL_7.6MM_8XD_A	03323691	7,6 0.299	64,0 2.520	116,0 4.567	80,0 3.150	36,0 1.417	76,0 2.992	8,0 0.315	140°	TiAIN	IT9
SD1108A-0770-064-08R1 SD_DRILL_7.7MM_8XD_A	03295029	7,7 0.303	64,0 2.520	116,0 4.567	80,0 3.150	36,0 1.417	76,0 2.992	8,0 0.315	140°	TiAIN	IT9
SD1108A-0780-064-08R1 SD_DRILL_7.8MM_8XD_A	03295030	7,8 0.307	64,0 2.520	116,0 4.567	80,0 3.150	36,0 1.417	76,0 2.992	8,0 0.315	140°	TiAIN	IT9
SD1108A-0790-064-08R1 SD_DRILL_7.9MM_8XD_A	03295031	7,9 0.311	64,0 2.520	116,0 4.567	80,0 3.150	36,0 1.417	76,0 2.992	8,0 0.315	140°	TiAIN	IT9
SD1108A-0794-064-08R1 SD_DRILL_5/16_8XD_A	03323692	7,938 0.313	64,0 2.520	116,0 4.567	80,0 3.150	36,0 1.417	76,0 2.992	8,0 0.315	140°	TiAIN	IT9
SD1108A-0800-064-08R1 SD_DRILL_8.0MM_8XD_A	03295032	8,0 0.315	64,0 2.520	116,0 4.567	80,0 3.150	36,0 1.417	76,0 2.992	8,0 0.315	140°	TiAIN	IT9
SD1108A-0810-080-10R1 SD_DRILL_8.1MM_8XD_A	03295033	8,1 0.319	80,0 3.150	139,0 5.472	99,0 3.898	40,0 1.575	95,0 3.740	10,0 0.394	140°	TiAIN	IT9
SD1108A-0820-080-10R1 SD_DRILL_8.2MM_8XD_A	03295034	8,2 0.323	80,0 3.150	139,0 5.472	99,0 3.898	40,0 1.575	95,0 3.740	10,0 0.394	140°	TiAIN	IT9
SD1108A-0830-080-10R1 SD_DRILL_8.3MM_8XD_A	03295035	8,3 0.327	80,0 3.150	139,0 5.472	99,0 3.898	40,0 1.575	95,0 3.740	10,0 0.394	140°	TiAIN	IT9
SD1108A-0833-080-10R1 SD_DRILL_21/64_8XD_A	03323693	8,334 0.328	80,0 3.150	139,0 5.472	99,0 3.898	40,0 1.575	95,0 3.740	10,0 0.394	140°	TiAIN	IT9
SD1108A-0840-080-10R1 SD_DRILL_8.4MM_8XD_A	03295036	8,4 0.331	80,0 3.150	139,0 5.472	99,0 3.898	40,0 1.575	95,0 3.740	10,0 0.394	140°	TiAIN	IT9
SD1108A-0850-080-10R1 SD_DRILL_8.5MM_8XD_A	03295037	8,5 0.335	80,0 3.150	139,0 5.472	99,0 3.898	40,0 1.575	95,0 3.740	10,0 0.394	140°	TiAIN	IT9
SD1108A-0860-080-10R1 SD_DRILL_8.6MM_8XD_A	03295038	8,6 0.339	80,0 3.150	139,0 5.472	99,0 3.898	40,0 1.575	95,0 3.740	10,0 0.394	140°	TiAIN	IT9
SD1108A-0870-080-10R1 SD_DRILL_8.7MM_8XD_A	03295039	8,7 0.343	80,0 3.150	139,0 5.472	99,0 3.898	40,0 1.575	95,0 3.740	10,0 0.394	140°	TiAIN	IT9
SD1108A-0873-080-10R1 SD_DRILL_11/32_8XD_A	03323694	8,731 0.344	80,0 3.150	139,0 5.472	99,0 3.898	40,0 1.575	95,0 3.740	10,0 0.394	140°	TiAIN	IT9
SD1108A-0880-080-10R1 SD_DRILL_8.8MM_8XD_A	03295040	8,8 0.346	80,0 3.150	139,0 5.472	99,0 3.898	40,0 1.575	95,0 3.740	10,0 0.394	140°	TiAIN	IT9
SD1108A-0900-080-10R1 SD_DRILL_9.0MM_8XD_A	03295041	9,0 0.354	80,0 3.150	139,0 5.472	99,0 3.898	40,0 1.575	95,0 3.740	10,0 0.394	140°	TiAIN	IT9
SD1108A-0910-080-10R1 SD_DRILL_9.1MM_8XD_A	03295042	9,1 0.358	80,0 3.150	139,0 5.472	99,0 3.898	40,0 1.575	95,0 3.740	10,0 0.394	140°	TiAIN	IT9
SD1108A-0913-080-10R1 SD_DRILL_23/64_8XD_A	03323695	9,128 0.359	80,0 3.150	139,0 5.472	99,0 3.898	40,0 1.575	95,0 3.740	10,0 0.394	140°	TiAIN	IT9
SD1108A-0930-080-10R1 SD_DRILL_9.3MM_8XD_A	03295043	9,3 0.366	80,0 3.150	139,0 5.472	99,0 3.898	40,0 1.575	95,0 3.740	10,0 0.394	140°	TiAIN	IT9
SD1108A-0940-080-10R1 SD_DRILL_9.4MM_8XD_A	03295044	9,4 0.370	80,0 3.150	139,0 5.472	99,0 3.898	40,0 1.575	95,0 3.740	10,0 0.394	140°	TiAIN	IT9
SD1108A-0950-080-10R1 SD_DRILL_9.5MM_8XD_A	03295045	9,5 0.374	80,0 3.150	139,0 5.472	99,0 3.898	40,0 1.575	95,0 3.740	10,0 0.394	140°	TiAIN	IT9
SD1108A-0953-080-10R1 SD_DRILL_3/8_8XD_A	03323696	9,525 0.375	80,0 3.150	139,0 5.472	99,0 3.898	40,0 1.575	95,0 3.740	10,0 0.394	140°	TiAIN	IT9
SD1108A-0970-080-10R1 SD_DRILL_9.7MM_8XD_A	03295046	9,7 0.382	80,0 3.150	139,0 5.472	99,0 3.898	40,0 1.575	95,0 3.740	10,0 0.394	140°	TiAIN	IT9
SD1108A-0980-080-10R1 SD_DRILL_9.8MM_8XD_A	03295047	9,8 0.386	80,0 3.150	139,0 5.472	99,0 3.898	40,0 1.575	95,0 3.740	10,0 0.394	140°	TiAIN	IT9
SD1108A-0990-080-10R1 SD_DRILL_9.9MM_8XD_A	03295048	9,9 0.390	80,0 3.150	139,0 5.472	99,0 3.898	40,0 1.575	95,0 3.740	10,0 0.394	140°	TiAIN	IT9

Wstęp

Wiercenie

Rozwiercanie

Wytaczanie

Załącznik

Oznaczenie	Numer produktu	DC	LU	OAL	LFS	LS	LCF	DMM	Kąt wierzchołkowy	Pokrycie	Tolerancja otworu
		mm Cal.	mm Cal.	mm Cal.	mm Cal.	mm Cal.	mm Cal.	mm Cal.			
SD1108A-0992-080-10R1 SD_DRILL_25/64_8XD_A	03323697	9,922 0.391	80,0 3.150	139,0 5.472	99,0 3.898	40,0 1.575	95,0 3.740	10,0 0.394	140°	TiAIN	IT9
SD1108A-1000-080-10R1 SD_DRILL_10.0MM_8XD_A	03295049	10,0 0.394	80,0 3.150	139,0 5.472	99,0 3.898	40,0 1.575	95,0 3.740	10,0 0.394	140°	TiAIN	IT9
SD1108A-1020-096-12R1 SD_DRILL_10.2MM_8XD_A	03295050	10,2 0.402	96,0 3.780	163,0 6.417	118,0 4.646	45,0 1.772	114,0 4.488	12,0 0.472	140°	TiAIN	IT9
SD1108A-1030-096-12R1 SD_DRILL_10.3MM_8XD_A	03295051	10,3 0.406	96,0 3.780	163,0 6.417	118,0 4.646	45,0 1.772	114,0 4.488	12,0 0.472	140°	TiAIN	IT9
SD1108A-1032-096-12R1 SD_DRILL_13/32_8XD_A	03323698	10,319 0.406	96,0 3.780	163,0 6.417	118,0 4.646	45,0 1.772	114,0 4.488	12,0 0.472	140°	TiAIN	IT9
SD1108A-1040-096-12R1 SD_DRILL_10.4MM_8XD_A	03295053	10,4 0.409	96,0 3.780	163,0 6.417	118,0 4.646	45,0 1.772	114,0 4.488	12,0 0.472	140°	TiAIN	IT9
SD1108A-1050-096-12R1 SD_DRILL_10.5MM_8XD_A	03295054	10,5 0.413	96,0 3.780	163,0 6.417	118,0 4.646	45,0 1.772	114,0 4.488	12,0 0.472	140°	TiAIN	IT9
SD1108A-1070-096-12R1 SD_DRILL_10.7MM_8XD_A	03295055	10,7 0.421	96,0 3.780	163,0 6.417	118,0 4.646	45,0 1.772	114,0 4.488	12,0 0.472	140°	TiAIN	IT9
SD1108A-1072-096-12R1 SD_DRILL_27/64_8XD_A	03323699	10,716 0.422	96,0 3.780	163,0 6.417	118,0 4.646	45,0 1.772	114,0 4.488	12,0 0.472	140°	TiAIN	IT9
SD1108A-1080-096-12R1 SD_DRILL_10.8MM_8XD_A	03295056	10,8 0.425	96,0 3.780	163,0 6.417	118,0 4.646	45,0 1.772	114,0 4.488	12,0 0.472	140°	TiAIN	IT9
SD1108A-1100-096-12R1 SD_DRILL_11.0MM_8XD_A	03295057	11,0 0.433	96,0 3.780	163,0 6.417	118,0 4.646	45,0 1.772	114,0 4.488	12,0 0.472	140°	TiAIN	IT9
SD1108A-1111-096-12R1 SD_DRILL_7/16_8XD_A	03323700	11,113 0.438	96,0 3.780	163,0 6.417	118,0 4.646	45,0 1.772	114,0 4.488	12,0 0.472	140°	TiAIN	IT9
SD1108A-1120-096-12R1 SD_DRILL_11.2MM_8XD_A	03295058	11,2 0.441	96,0 3.780	163,0 6.417	118,0 4.646	45,0 1.772	114,0 4.488	12,0 0.472	140°	TiAIN	IT9
SD1108A-1130-096-12R1 SD_DRILL_11.3MM_8XD_A	03295059	11,3 0.445	96,0 3.780	163,0 6.417	118,0 4.646	45,0 1.772	114,0 4.488	12,0 0.472	140°	TiAIN	IT9
SD1108A-1150-096-12R1 SD_DRILL_11.5MM_8XD_A	03295060	11,5 0.453	96,0 3.780	163,0 6.417	118,0 4.646	45,0 1.772	114,0 4.488	12,0 0.472	140°	TiAIN	IT9
SD1108A-1170-096-12R1 SD_DRILL_11.7MM_8XD_A	03295061	11,7 0.461	96,0 3.780	163,0 6.417	118,0 4.646	45,0 1.772	114,0 4.488	12,0 0.472	140°	TiAIN	IT9
SD1108A-1180-096-12R1 SD_DRILL_11.8MM_8XD_A	03295062	11,8 0.465	96,0 3.780	163,0 6.417	118,0 4.646	45,0 1.772	114,0 4.488	12,0 0.472	140°	TiAIN	IT9
SD1108A-1190-096-12R1 SD_DRILL_11.9MM_8XD_A	03295063	11,9 0.469	96,0 3.780	163,0 6.417	118,0 4.646	45,0 1.772	114,0 4.488	12,0 0.472	140°	TiAIN	IT9
SD1108A-1191-096-12R1 SD_DRILL_15/32_8XD_A	03323701	11,906 0.469	96,0 3.780	163,0 6.417	118,0 4.646	45,0 1.772	114,0 4.488	12,0 0.472	140°	TiAIN	IT9
SD1108A-1200-096-12R1 SD_DRILL_12.0MM_8XD_A	03295064	12,0 0.472	96,0 3.780	163,0 6.417	118,0 4.646	45,0 1.772	114,0 4.488	12,0 0.472	140°	TiAIN	IT9
SD1108A-1230-119-14R1 SD_DRILL_31/64_8XD_A	03295065	12,3 0.484	119,0 4.685	182,0 7.165	137,0 5.394	45,0 1.772	133,0 5.236	14,0 0.551	140°	TiAIN	IT9
SD1108A-1250-119-14R1 SD_DRILL_12.5MM_8XD_A	03295066	12,5 0.492	119,0 4.685	182,0 7.165	137,0 5.394	45,0 1.772	133,0 5.236	14,0 0.551	140°	TiAIN	IT9
SD1108A-1270-119-14R1 SD_DRILL_1/2_8XD_A	03295067	12,7 0.500	119,0 4.685	182,0 7.165	137,0 5.394	45,0 1.772	133,0 5.236	14,0 0.551	140°	TiAIN	IT9
SD1108A-1300-119-14R1 SD_DRILL_13.0MM_8XD_A	03295068	13,0 0.512	119,0 4.685	182,0 7.165	137,0 5.394	45,0 1.772	133,0 5.236	14,0 0.551	140°	TiAIN	IT9
SD1108A-1349-119-14R1 SD_DRILL_17/32_8XD_A	03323702	13,494 0.531	119,0 4.685	182,0 7.165	137,0 5.394	45,0 1.772	133,0 5.236	14,0 0.551	140°	TiAIN	IT9
SD1108A-1350-119-14R1 SD_DRILL_13.5MM_8XD_A	03295069	13,5 0.531	119,0 4.685	182,0 7.165	137,0 5.394	45,0 1.772	133,0 5.236	14,0 0.551	140°	TiAIN	IT9
SD1108A-1400-119-14R1 SD_DRILL_14.0MM_8XD_A	03295070	14,0 0.551	119,0 4.685	182,0 7.165	137,0 5.394	45,0 1.772	133,0 5.236	14,0 0.551	140°	TiAIN	IT9
SD1108A-1429-136-16R1 SD_DRILL_9/16_8XD_A	03295071	14,288 0.563	136,0 5.354	204,0 8.031	156,0 6.142	48,0 1.890	152,0 5.984	16,0 0.630	140°	TiAIN	IT9
SD1108A-1450-136-16R1 SD_DRILL_14.5MM_8XD_A	03295072	14,5 0.571	136,0 5.354	204,0 8.031	156,0 6.142	48,0 1.890	152,0 5.984	16,0 0.630	140°	TiAIN	IT9
SD1108A-1500-136-16R1 SD_DRILL_15.0MM_8XD_A	03295073	15,0 0.591	136,0 5.354	204,0 8.031	156,0 6.142	48,0 1.890	152,0 5.984	16,0 0.630	140°	TiAIN	IT9
SD1108A-1550-136-16R1 SD_DRILL_15.5MM_8XD_A	03295074	15,5 0.610	136,0 5.354	204,0 8.031	156,0 6.142	48,0 1.890	152,0 5.984	16,0 0.630	140°	TiAIN	IT9

Wstęp

Wiercenie

Rozwiercanie

Wyłaczanie

Załącznik

Oznaczenie	Numer produktu	DC	LU	OAL	LFS	LS	LCF	DMM	Kąt wierzchołkowy	Pokrycie	Tolerancja otworu
		mm <i>Cal.</i>	mm <i>Cal.</i>	mm <i>Cal.</i>	mm <i>Cal.</i>	mm <i>Cal.</i>	mm <i>Cal.</i>	mm <i>Cal.</i>			
SD1108A-1588-136-16R1 <i>SD_DRILL_5/8_8XD_A</i>	03295075	15,875 <i>0.625</i>	136,0 <i>5.354</i>	204,0 <i>8.031</i>	156,0 <i>6.142</i>	48,0 <i>1.890</i>	152,0 <i>5.984</i>	16,0 <i>0.630</i>	140°	TiAIN	IT9
SD1108A-1600-136-16R1 <i>SD_DRILL_16.0MM_8XD_A</i>	03295076	16,0 <i>0.630</i>	136,0 <i>5.354</i>	204,0 <i>8.031</i>	156,0 <i>6.142</i>	48,0 <i>1.890</i>	152,0 <i>5.984</i>	16,0 <i>0.630</i>	140°	TiAIN	IT9
SD1108A-1650-153-18R1 <i>SD_DRILL_16.5MM_8XD_A</i>	03295077	16,5 <i>0.650</i>	153,0 <i>6.024</i>	223,0 <i>8.780</i>	175,0 <i>6.890</i>	48,0 <i>1.890</i>	171,0 <i>6.732</i>	18,0 <i>0.709</i>	140°	TiAIN	IT9
SD1108A-1700-153-18R1 <i>SD_DRILL_17.0MM_8XD_A</i>	03295078	17,0 <i>0.669</i>	153,0 <i>6.024</i>	223,0 <i>8.780</i>	175,0 <i>6.890</i>	48,0 <i>1.890</i>	171,0 <i>6.732</i>	18,0 <i>0.709</i>	140°	TiAIN	IT9
SD1108A-1750-153-18R1 <i>SD_DRILL_17.5MM_8XD_A</i>	03295079	17,5 <i>0.689</i>	153,0 <i>6.024</i>	223,0 <i>8.780</i>	175,0 <i>6.890</i>	48,0 <i>1.890</i>	171,0 <i>6.732</i>	18,0 <i>0.709</i>	140°	TiAIN	IT9
SD1108A-1800-153-18R1 <i>SD_DRILL_18.0MM_8XD_A</i>	03295080	18,0 <i>0.709</i>	153,0 <i>6.024</i>	223,0 <i>8.780</i>	175,0 <i>6.890</i>	48,0 <i>1.890</i>	171,0 <i>6.732</i>	18,0 <i>0.709</i>	140°	TiAIN	IT9
SD1108A-1850-170-20R1 <i>SD_DRILL_18.5MM_8XD_A</i>	03295081	18,5 <i>0.728</i>	170,0 <i>6.693</i>	244,0 <i>9.606</i>	194,0 <i>7.638</i>	50,0 <i>1.969</i>	190,0 <i>7.480</i>	20,0 <i>0.787</i>	140°	TiAIN	IT9
SD1108A-1900-170-20R1 <i>SD_DRILL_19.0MM_8XD_A</i>	03295082	19,0 <i>0.748</i>	170,0 <i>6.693</i>	244,0 <i>9.606</i>	194,0 <i>7.638</i>	50,0 <i>1.969</i>	190,0 <i>7.480</i>	20,0 <i>0.787</i>	140°	TiAIN	IT9
SD1108A-1905-170-20R1 <i>SD_DRILL_3/4_8XD_A</i>	03323703	19,05 <i>0.750</i>	170,0 <i>6.693</i>	244,0 <i>9.606</i>	194,0 <i>7.638</i>	50,0 <i>1.969</i>	190,0 <i>7.480</i>	20,0 <i>0.787</i>	140°	TiAIN	IT9
SD1108A-1950-170-20R1 <i>SD_DRILL_19.5MM_8XD_A</i>	03295083	19,5 <i>0.768</i>	170,0 <i>6.693</i>	244,0 <i>9.606</i>	194,0 <i>7.638</i>	50,0 <i>1.969</i>	190,0 <i>7.480</i>	20,0 <i>0.787</i>	140°	TiAIN	IT9
SD1108A-2000-170-20R1 <i>SD_DRILL_20.0MM_8XD_A</i>	03295084	20,0 <i>0.787</i>	170,0 <i>6.693</i>	244,0 <i>9.606</i>	194,0 <i>7.638</i>	50,0 <i>1.969</i>	190,0 <i>7.480</i>	20,0 <i>0.787</i>	140°	TiAIN	IT9

Wstęp

Wiercenie

Rozwiercanie

Wytaczanie

Załącznik

SD1112A

Głębokość wiercenia ~ 12 x D – Metryczne/Calowe

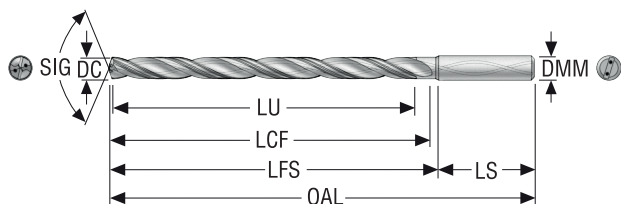

- Chwył cylindryczny DIN 6537A
- Tolerancja DC m7
- Chłodzenie wewnętrzne
- Parametry skrawania, patrz strona (strony) 143
- Średnice pośrednie patrz aplikacja MyDesign.

Oznaczenie	Numer produktu	DC	LU	OAL	LFS	LS	LCF	DMM	Kąt wierzchołkowy	Pokrycie	Tolerancja otworu
		mm Cal.	mm Cal.	mm Cal.	mm Cal.	mm Cal.	mm Cal.	mm Cal.			
SD1112A-0300-048-06R1 SD_DRILL_3.0MM_12XD_A	03295085	3,0 0.118	48,0 1.890	92,0 3.622	56,0 2.205	36,0 1.417	54,0 2.126	6,0 0.236	140°	TiAIN	IT9
SD1112A-0310-048-06R1 SD_DRILL_3.1MM_12XD_A	03295086	3,1 0.122	48,0 1.890	92,0 3.622	56,0 2.205	36,0 1.417	54,0 2.126	6,0 0.236	140°	TiAIN	IT9
SD1112A-0318-048-06R1 SD_DRILL_1/8_12XD_A	03323704	3,175 0.125	48,0 1.890	92,0 3.622	56,0 2.205	36,0 1.417	54,0 2.126	6,0 0.236	140°	TiAIN	IT9
SD1112A-0320-048-06R1 SD_DRILL_3.2MM_12XD_A	03295087	3,2 0.126	48,0 1.890	92,0 3.622	56,0 2.205	36,0 1.417	54,0 2.126	6,0 0.236	140°	TiAIN	IT9
SD1112A-0330-048-06R1 SD_DRILL_3.3MM_12XD_A	03295088	3,3 0.130	48,0 1.890	92,0 3.622	56,0 2.205	36,0 1.417	54,0 2.126	6,0 0.236	140°	TiAIN	IT9
SD1112A-0340-048-06R1 SD_DRILL_3.4MM_12XD_A	03295089	3,4 0.134	48,0 1.890	92,0 3.622	56,0 2.205	36,0 1.417	54,0 2.126	6,0 0.236	140°	TiAIN	IT9
SD1112A-0350-048-06R1 SD_DRILL_3.5MM_12XD_A	03295090	3,5 0.138	48,0 1.890	92,0 3.622	56,0 2.205	36,0 1.417	54,0 2.126	6,0 0.236	140°	TiAIN	IT9
SD1112A-0357-048-06R1 SD_DRILL_9/64_12XD_A	03323705	3,572 0.141	48,0 1.890	92,0 3.622	56,0 2.205	36,0 1.417	54,0 2.126	6,0 0.236	140°	TiAIN	IT9
SD1112A-0360-048-06R1 SD_DRILL_3.6MM_12XD_A	03295091	3,6 0.142	48,0 1.890	92,0 3.622	56,0 2.205	36,0 1.417	54,0 2.126	6,0 0.236	140°	TiAIN	IT9
SD1112A-0370-048-06R1 SD_DRILL_3.7MM_12XD_A	03295092	3,7 0.146	48,0 1.890	92,0 3.622	56,0 2.205	36,0 1.417	54,0 2.126	6,0 0.236	140°	TiAIN	IT9
SD1112A-0380-056-06R1 SD_DRILL_3.8MM_12XD_A	03295093	3,8 0.150	56,0 2.205	102,0 4.016	66,0 2.598	36,0 1.417	64,0 2.520	6,0 0.236	140°	TiAIN	IT9
SD1112A-0390-056-06R1 SD_DRILL_3.9MM_12XD_A	03295094	3,9 0.154	56,0 2.205	102,0 4.016	66,0 2.598	36,0 1.417	64,0 2.520	6,0 0.236	140°	TiAIN	IT9
SD1112A-0397-056-06R1 SD_DRILL_5/32_12XD_A	03323706	3,969 0.156	56,0 2.205	102,0 4.016	66,0 2.598	36,0 1.417	64,0 2.520	6,0 0.236	140°	TiAIN	IT9
SD1112A-0400-056-06R1 SD_DRILL_4.0MM_12XD_A	03295095	4,0 0.157	56,0 2.205	102,0 4.016	66,0 2.598	36,0 1.417	64,0 2.520	6,0 0.236	140°	TiAIN	IT9
SD1112A-0410-056-06R1 SD_DRILL_4.1MM_12XD_A	03295096	4,1 0.161	56,0 2.205	102,0 4.016	66,0 2.598	36,0 1.417	64,0 2.520	6,0 0.236	140°	TiAIN	IT9
SD1112A-0420-056-06R1 SD_DRILL_4.2MM_12XD_A	03295097	4,2 0.165	56,0 2.205	102,0 4.016	66,0 2.598	36,0 1.417	64,0 2.520	6,0 0.236	140°	TiAIN	IT9
SD1112A-0430-056-06R1 SD_DRILL_4.3MM_12XD_A	03295098	4,3 0.169	56,0 2.205	102,0 4.016	66,0 2.598	36,0 1.417	64,0 2.520	6,0 0.236	140°	TiAIN	IT9
SD1112A-0437-056-06R1 SD_DRILL_11/64_12XD_A	03323707	4,366 0.172	56,0 2.205	102,0 4.016	66,0 2.598	36,0 1.417	64,0 2.520	6,0 0.236	140°	TiAIN	IT9
SD1112A-0440-056-06R1 SD_DRILL_4.4MM_12XD_A	03295099	4,4 0.173	56,0 2.205	102,0 4.016	66,0 2.598	36,0 1.417	64,0 2.520	6,0 0.236	140°	TiAIN	IT9
SD1112A-0450-056-06R1 SD_DRILL_4.5MM_12XD_A	03295100	4,5 0.177	56,0 2.205	102,0 4.016	66,0 2.598	36,0 1.417	64,0 2.520	6,0 0.236	140°	TiAIN	IT9
SD1112A-0460-056-06R1 SD_DRILL_4.6MM_12XD_A	03295101	4,6 0.181	56,0 2.205	102,0 4.016	66,0 2.598	36,0 1.417	64,0 2.520	6,0 0.236	140°	TiAIN	IT9

Oznaczenie	Numer produktu	DC	LU	OAL	LFS	LS	LCF	DMM	Kąt wierzchołkowy	Pokrycie	Tolerancja otworu
		mm Cal.	mm Cal.	mm Cal.	mm Cal.	mm Cal.	mm Cal.	mm Cal.			
SD1112A-0470-056-06R1 SD_DRILL_4.7MM_12XD_A	03295102	4,7 0.185	56,0 2.205	102,0 4.016	66,0 2.598	36,0 1.417	64,0 2.520	6,0 0.236	140°	TiAIN	IT9
SD1112A-0476-074-06R1 SD_DRILL_3/16_12XD_A	03323708	4,763 0.188	74,0 2.913	121,0 4.764	85,0 3.346	36,0 1.417	83,0 3.268	6,0 0.236	140°	TiAIN	IT9
SD1112A-0480-074-06R1 SD_DRILL_4.8MM_12XD_A	03295103	4,8 0.189	74,0 2.913	121,0 4.764	85,0 3.346	36,0 1.417	83,0 3.268	6,0 0.236	140°	TiAIN	IT9
SD1112A-0490-074-06R1 SD_DRILL_4.9MM_12XD_A	03295104	4,9 0.193	74,0 2.913	121,0 4.764	85,0 3.346	36,0 1.417	83,0 3.268	6,0 0.236	140°	TiAIN	IT9
SD1112A-0500-074-06R1 SD_DRILL_5.0MM_12XD_A	03295105	5,0 0.197	74,0 2.913	121,0 4.764	85,0 3.346	36,0 1.417	83,0 3.268	6,0 0.236	140°	TiAIN	IT9
SD1112A-0510-074-06R1 SD_DRILL_5.1MM_12XD_A	03295106	5,1 0.201	74,0 2.913	121,0 4.764	85,0 3.346	36,0 1.417	83,0 3.268	6,0 0.236	140°	TiAIN	IT9
SD1112A-0516-074-06R1 SD_DRILL_13/64_12XD_A	03323709	5,159 0.203	74,0 2.913	121,0 4.764	85,0 3.346	36,0 1.417	83,0 3.268	6,0 0.236	140°	TiAIN	IT9
SD1112A-0520-074-06R1 SD_DRILL_5.2MM_12XD_A	03295107	5,2 0.205	74,0 2.913	121,0 4.764	85,0 3.346	36,0 1.417	83,0 3.268	6,0 0.236	140°	TiAIN	IT9
SD1112A-0530-074-06R1 SD_DRILL_5.3MM_12XD_A	03295108	5,3 0.209	74,0 2.913	121,0 4.764	85,0 3.346	36,0 1.417	83,0 3.268	6,0 0.236	140°	TiAIN	IT9
SD1112A-0540-074-06R1 SD_DRILL_5.4MM_12XD_A	03295109	5,4 0.213	74,0 2.913	121,0 4.764	85,0 3.346	36,0 1.417	83,0 3.268	6,0 0.236	140°	TiAIN	IT9
SD1112A-0550-074-06R1 SD_DRILL_5.5MM_12XD_A	03295110	5,5 0.217	74,0 2.913	121,0 4.764	85,0 3.346	36,0 1.417	83,0 3.268	6,0 0.236	140°	TiAIN	IT9
SD1112A-0556-074-06R1 SD_DRILL_7/32_12XD_A	03295111	5,556 0.219	74,0 2.913	121,0 4.764	85,0 3.346	36,0 1.417	83,0 3.268	6,0 0.236	140°	TiAIN	IT9
SD1112A-0560-074-06R1 SD_DRILL_5.6MM_12XD_A	03295112	5,6 0.220	74,0 2.913	121,0 4.764	85,0 3.346	36,0 1.417	83,0 3.268	6,0 0.236	140°	TiAIN	IT9
SD1112A-0570-074-06R1 SD_DRILL_5.7MM_12XD_A	03295113	5,7 0.224	74,0 2.913	121,0 4.764	85,0 3.346	36,0 1.417	83,0 3.268	6,0 0.236	140°	TiAIN	IT9
SD1112A-0580-074-06R1 SD_DRILL_5.8MM_12XD_A	03295114	5,8 0.228	74,0 2.913	121,0 4.764	85,0 3.346	36,0 1.417	83,0 3.268	6,0 0.236	140°	TiAIN	IT9
SD1112A-0590-074-06R1 SD_DRILL_5.9MM_12XD_A	03295115	5,9 0.232	74,0 2.913	121,0 4.764	85,0 3.346	36,0 1.417	83,0 3.268	6,0 0.236	140°	TiAIN	IT9
SD1112A-0600-074-06R1 SD_DRILL_6.0MM_12XD_A	03295116	6,0 0.236	74,0 2.913	121,0 4.764	85,0 3.346	36,0 1.417	83,0 3.268	6,0 0.236	140°	TiAIN	IT9
SD1112A-0610-098-08R1 SD_DRILL_6.1MM_12XD_A	03295117	6,1 0.240	98,0 3.858	148,0 5.827	112,0 4.409	36,0 1.417	110,0 4.331	8,0 0.315	140°	TiAIN	IT9
SD1112A-0620-098-08R1 SD_DRILL_6.2MM_12XD_A	03295118	6,2 0.244	98,0 3.858	148,0 5.827	112,0 4.409	36,0 1.417	110,0 4.331	8,0 0.315	140°	TiAIN	IT9
SD1112A-0630-098-08R1 SD_DRILL_6.3MM_12XD_A	03295119	6,3 0.248	98,0 3.858	148,0 5.827	112,0 4.409	36,0 1.417	110,0 4.331	8,0 0.315	140°	TiAIN	IT9
SD1112A-0635-098-08R1 SD_DRILL_1/4_12XD_A	03295120	6,35 0.250	98,0 3.858	148,0 5.827	112,0 4.409	36,0 1.417	110,0 4.331	8,0 0.315	140°	TiAIN	IT9
SD1112A-0640-098-08R1 SD_DRILL_6.4MM_12XD_A	03295121	6,4 0.252	98,0 3.858	148,0 5.827	112,0 4.409	36,0 1.417	110,0 4.331	8,0 0.315	140°	TiAIN	IT9
SD1112A-0650-098-08R1 SD_DRILL_6.5MM_12XD_A	03295122	6,5 0.256	98,0 3.858	148,0 5.827	112,0 4.409	36,0 1.417	110,0 4.331	8,0 0.315	140°	TiAIN	IT9
SD1112A-0660-098-08R1 SD_DRILL_6.6MM_12XD_A	03295123	6,6 0.260	98,0 3.858	148,0 5.827	112,0 4.409	36,0 1.417	110,0 4.331	8,0 0.315	140°	TiAIN	IT9
SD1112A-0670-098-08R1 SD_DRILL_6.7MM_12XD_A	03295124	6,7 0.264	98,0 3.858	148,0 5.827	112,0 4.409	36,0 1.417	110,0 4.331	8,0 0.315	140°	TiAIN	IT9
SD1112A-0675-098-08R1 SD_DRILL_17/64_12XD_A	03323710	6,747 0.266	98,0 3.858	148,0 5.827	128,0 5.039	36,0 1.417	110,0 4.331	8,0 0.315	140°	TiAIN	IT9
SD1112A-0680-098-08R1 SD_DRILL_6.8MM_12XD_A	03295125	6,8 0.268	98,0 3.858	148,0 5.827	112,0 4.409	36,0 1.417	110,0 4.331	8,0 0.315	140°	TiAIN	IT9
SD1112A-0690-098-08R1 SD_DRILL_6.9MM_12XD_A	03295126	6,9 0.272	98,0 3.858	148,0 5.827	112,0 4.409	36,0 1.417	110,0 4.331	8,0 0.315	140°	TiAIN	IT9
SD1112A-0700-098-08R1 SD_DRILL_7.0MM_12XD_A	03295127	7,0 0.276	98,0 3.858	148,0 5.827	112,0 4.409	36,0 1.417	110,0 4.331	8,0 0.315	140°	TiAIN	IT9
SD1112A-0710-098-08R1 SD_DRILL_7.1MM_12XD_A	03295128	7,1 0.280	98,0 3.858	148,0 5.827	112,0 4.409	36,0 1.417	110,0 4.331	8,0 0.315	140°	TiAIN	IT9
SD1112A-0714-098-08R1 SD_DRILL_9/32_12XD_A	03323711	7,144 0.281	98,0 3.858	148,0 5.827	128,0 5.039	36,0 1.417	110,0 4.331	8,0 0.315	140°	TiAIN	IT9

Wstęp

Wiercenie

Rozwiercanie

Wytaczanie

Załącznik

Oznaczenie	Numer produktu	DC	LU	OAL	LFS	LS	LCF	DMM	Kąt wierzchołkowy	Pokrycie	Tolerancja otworu
		mm Cal.	mm Cal.	mm Cal.	mm Cal.	mm Cal.	mm Cal.	mm Cal.	mm Cal.		
SD1112A-0730-098-08R1 SD_DRILL_7.3MM_12XD_A	03323712	7,3 0.287	98,0 3.858	148,0 5.827	128,0 5.039	36,0 1.417	110,0 4.331	8,0 0.315	140°	TiAIN	IT9
SD1112A-0740-098-08R1 SD_DRILL_7.4MM_12XD_A	03295129	7,4 0.291	98,0 3.858	148,0 5.827	112,0 4.409	36,0 1.417	110,0 4.331	8,0 0.315	140°	TiAIN	IT9
SD1112A-0750-098-08R1 SD_DRILL_7.5MM_12XD_A	03295130	7,5 0.295	98,0 3.858	148,0 5.827	112,0 4.409	36,0 1.417	110,0 4.331	8,0 0.315	140°	TiAIN	IT9
SD1112A-0754-098-08R1 SD_DRILL_19/64_12XD_A	03323713	7,541 0.297	98,0 3.858	148,0 5.827	128,0 5.039	36,0 1.417	110,0 4.331	8,0 0.315	140°	TiAIN	IT9
SD1112A-0780-098-08R1 SD_DRILL_7.8MM_12XD_A	03295131	7,8 0.307	98,0 3.858	148,0 5.827	112,0 4.409	36,0 1.417	110,0 4.331	8,0 0.315	140°	TiAIN	IT9
SD1112A-0790-098-08R1 SD_DRILL_7.9MM_12XD_A	03295132	7,9 0.311	98,0 3.858	148,0 5.827	112,0 4.409	36,0 1.417	110,0 4.331	8,0 0.315	140°	TiAIN	IT9
SD1112A-0794-098-08R1 SD_DRILL_5/16_12XD_A	03323714	7,938 0.313	98,0 3.858	148,0 5.827	128,0 5.039	36,0 1.417	110,0 4.331	8,0 0.315	140°	TiAIN	IT9
SD1112A-0800-098-08R1 SD_DRILL_8.0MM_12XD_A	03295133	8,0 0.315	98,0 3.858	148,0 5.827	112,0 4.409	36,0 1.417	110,0 4.331	8,0 0.315	140°	TiAIN	IT9
SD1112A-0810-123-10R1 SD_DRILL_8.1MM_12XD_A	03295135	8,1 0.319	123,0 4.843	180,0 7.087	140,0 5.512	40,0 1.575	138,0 5.433	10,0 0.394	140°	TiAIN	IT9
SD1112A-0820-123-10R1 SD_DRILL_8.2MM_12XD_A	03295136	8,2 0.323	123,0 4.843	180,0 7.087	140,0 5.512	40,0 1.575	138,0 5.433	10,0 0.394	140°	TiAIN	IT9
SD1112A-0830-123-10R1 SD_DRILL_8.3MM_12XD_A	03295137	8,3 0.327	123,0 4.843	180,0 7.087	140,0 5.512	40,0 1.575	138,0 5.433	10,0 0.394	140°	TiAIN	IT9
SD1112A-0840-123-10R1 SD_DRILL_8.4MM_12XD_A	03295138	8,4 0.331	123,0 4.843	180,0 7.087	140,0 5.512	40,0 1.575	138,0 5.433	10,0 0.394	140°	TiAIN	IT9
SD1112A-0850-123-10R1 SD_DRILL_8.5MM_12XD_A	03295139	8,5 0.335	123,0 4.843	180,0 7.087	140,0 5.512	40,0 1.575	138,0 5.433	10,0 0.394	140°	TiAIN	IT9
SD1112A-0860-123-10R1 SD_DRILL_8.6MM_12XD_A	03295140	8,6 0.339	123,0 4.843	180,0 7.087	140,0 5.512	40,0 1.575	138,0 5.433	10,0 0.394	140°	TiAIN	IT9
SD1112A-0870-123-10R1 SD_DRILL_8.7MM_12XD_A	03295141	8,7 0.343	123,0 4.843	180,0 7.087	140,0 5.512	40,0 1.575	138,0 5.433	10,0 0.394	140°	TiAIN	IT9
SD1112A-0873-123-10R1 SD_DRILL_11/32_12XD_A	03323715	8,731 0.344	123,0 4.843	180,0 7.087	140,0 5.512	40,0 1.575	138,0 5.433	10,0 0.394	140°	TiAIN	IT9
SD1112A-0880-123-10R1 SD_DRILL_8.8MM_12XD_A	03295142	8,8 0.346	123,0 4.843	180,0 7.087	140,0 5.512	40,0 1.575	138,0 5.433	10,0 0.394	140°	TiAIN	IT9
SD1112A-0900-123-10R1 SD_DRILL_9.0MM_12XD_A	03295143	9,0 0.354	123,0 4.843	180,0 7.087	140,0 5.512	40,0 1.575	138,0 5.433	10,0 0.394	140°	TiAIN	IT9
SD1112A-0913-123-10R1 SD_DRILL_23/64_12XD_A	03323716	9,128 0.359	123,0 4.843	180,0 7.087	140,0 5.512	40,0 1.575	138,0 5.433	10,0 0.394	140°	TiAIN	IT9
SD1112A-0930-123-10R1 SD_DRILL_9.3MM_12XD_A	03295144	9,3 0.366	123,0 4.843	180,0 7.087	140,0 5.512	40,0 1.575	138,0 5.433	10,0 0.394	140°	TiAIN	IT9
SD1112A-0950-123-10R1 SD_DRILL_9.5MM_12XD_A	03295145	9,5 0.374	123,0 4.843	180,0 7.087	140,0 5.512	40,0 1.575	138,0 5.433	10,0 0.394	140°	TiAIN	IT9
SD1112A-0953-123-10R1 SD_DRILL_3/8_12XD_A	03323717	9,525 0.375	123,0 4.843	180,0 7.087	140,0 5.512	40,0 1.575	138,0 5.433	10,0 0.394	140°	TiAIN	IT9
SD1112A-0970-123-10R1 SD_DRILL_9.7MM_12XD_A	03295146	9,7 0.382	123,0 4.843	180,0 7.087	140,0 5.512	40,0 1.575	138,0 5.433	10,0 0.394	140°	TiAIN	IT9
SD1112A-0980-123-10R1 SD_DRILL_9.8MM_12XD_A	03295147	9,8 0.386	123,0 4.843	180,0 7.087	140,0 5.512	40,0 1.575	138,0 5.433	10,0 0.394	140°	TiAIN	IT9
SD1112A-0992-123-10R1 SD_DRILL_25/64_12XD_A	03323718	9,922 0.391	123,0 4.843	180,0 7.087	140,0 5.512	40,0 1.575	138,0 5.433	10,0 0.394	140°	TiAIN	IT9
SD1112A-1000-123-10R1 SD_DRILL_10.0MM_12XD_A	03295148	10,0 0.394	123,0 4.843	180,0 7.087	140,0 5.512	40,0 1.575	138,0 5.433	10,0 0.394	140°	TiAIN	IT9
SD1112A-1020-140-12R1 SD_DRILL_10.2MM_12XD_A	03295149	10,2 0.402	140,0 5.512	206,0 8.110	161,0 6.339	45,0 1.772	158,0 6.220	12,0 0.472	140°	TiAIN	IT9
SD1112A-1030-140-12R1 SD_DRILL_10.3MM_12XD_A	03295150	10,3 0.406	140,0 5.512	206,0 8.110	161,0 6.339	45,0 1.772	158,0 6.220	12,0 0.472	140°	TiAIN	IT9
SD1112A-1032-140-12R1 SD_DRILL_13/32_12XD_A	03323719	10,319 0.406	140,0 5.512	206,0 8.110	161,0 6.339	45,0 1.772	158,0 6.220	12,0 0.472	140°	TiAIN	IT9
SD1112A-1050-140-12R1 SD_DRILL_10.5MM_12XD_A	03295151	10,5 0.413	140,0 5.512	206,0 8.110	161,0 6.339	45,0 1.772	158,0 6.220	12,0 0.472	140°	TiAIN	IT9
SD1112A-1072-140-12R1 SD_DRILL_27/64_12XD_A	03323720	10,716 0.422	140,0 5.512	206,0 8.110	161,0 6.339	45,0 1.772	158,0 6.220	12,0 0.472	140°	TiAIN	IT9

Oznaczenie	Numer produktu	DC	LU	OAL	LFS	LS	LCF	DMM	Kąt wierzchołkowy	Pokrycie	Tolerancja otworu
		mm Cal.	mm Cal.	mm Cal.	mm Cal.	mm Cal.	mm Cal.	mm Cal.			
SD1112A-1080-140-12R1 SD_DRILL_10.8MM_12XD_A	03295152	10,8 0.425	140,0 5.512	206,0 8.110	161,0 6.339	45,0 1.772	158,0 6.220	12,0 0.472	140°	TiAIN	IT9
SD1112A-1100-140-12R1 SD_DRILL_11.0MM_12XD_A	03295153	11,0 0.433	140,0 5.512	206,0 8.110	161,0 6.339	45,0 1.772	158,0 6.220	12,0 0.472	140°	TiAIN	IT9
SD1112A-1111-140-12R1 SD_DRILL_7/16_12XD_A	03323722	11,113 0.438	140,0 5.512	206,0 8.110	161,0 6.339	45,0 1.772	158,0 6.220	12,0 0.472	140°	TiAIN	IT9
SD1112A-1120-140-12R1 SD_DRILL_11.2MM_12XD_A	03295154	11,2 0.441	140,0 5.512	206,0 8.110	161,0 6.339	45,0 1.772	158,0 6.220	12,0 0.472	140°	TiAIN	IT9
SD1112A-1150-140-12R1 SD_DRILL_11.5MM_12XD_A	03295155	11,5 0.453	140,0 5.512	206,0 8.110	161,0 6.339	45,0 1.772	158,0 6.220	12,0 0.472	140°	TiAIN	IT9
SD1112A-1170-140-12R1 SD_DRILL_11.7MM_12XD_A	03295156	11,7 0.461	140,0 5.512	206,0 8.110	161,0 6.339	45,0 1.772	158,0 6.220	12,0 0.472	140°	TiAIN	IT9
SD1112A-1180-140-12R1 SD_DRILL_11.8MM_12XD_A	03295157	11,8 0.465	140,0 5.512	206,0 8.110	161,0 6.339	45,0 1.772	158,0 6.220	12,0 0.472	140°	TiAIN	IT9
SD1112A-1191-140-12R1 SD_DRILL_15/32_12XD_A	03323723	11,906 0.469	140,0 5.512	206,0 8.110	161,0 6.339	45,0 1.772	158,0 6.220	12,0 0.472	140°	TiAIN	IT9
SD1112A-1200-140-12R1 SD_DRILL_12.0MM_12XD_A	03295158	12,0 0.472	140,0 5.512	206,0 8.110	161,0 6.339	45,0 1.772	158,0 6.220	12,0 0.472	140°	TiAIN	IT9
SD1112A-1220-168-14R1 SD_DRILL_12.2MM_12XD_A	03295159	12,2 0.480	168,0 6.614	230,0 9.055	185,0 7.283	45,0 1.772	182,0 7.165	14,0 0.551	140°	TiAIN	IT9
SD1112A-1230-168-14R1 SD_DRILL_31/64_12XD_A	03295160	12,3 0.484	168,0 6.614	230,0 9.055	185,0 7.283	45,0 1.772	182,0 7.165	14,0 0.551	140°	TiAIN	IT9
SD1112A-1250-168-14R1 SD_DRILL_12.5MM_12XD_A	03295161	12,5 0.492	168,0 6.614	230,0 9.055	185,0 7.283	45,0 1.772	182,0 7.165	14,0 0.551	140°	TiAIN	IT9
SD1112A-1270-168-14R1 SD_DRILL_1/2_12XD_A	03295162	12,7 0.500	168,0 6.614	230,0 9.055	185,0 7.283	45,0 1.772	182,0 7.165	14,0 0.551	140°	TiAIN	IT9
SD1112A-1300-168-14R1 SD_DRILL_13.0MM_12XD_A	03295163	13,0 0.512	168,0 6.614	230,0 9.055	185,0 7.283	45,0 1.772	182,0 7.165	14,0 0.551	140°	TiAIN	IT9
SD1112A-1349-168-14R1 SD_DRILL_17/32_12XD_A	03323724	13,494 0.531	168,0 6.614	230,0 9.055	185,0 7.283	45,0 1.772	182,0 7.165	14,0 0.551	140°	TiAIN	IT9
SD1112A-1350-168-14R1 SD_DRILL_13.5MM_12XD_A	03295164	13,5 0.531	168,0 6.614	230,0 9.055	185,0 7.283	45,0 1.772	182,0 7.165	14,0 0.551	140°	TiAIN	IT9
SD1112A-1400-168-14R1 SD_DRILL_14.0MM_12XD_A	03295165	14,0 0.551	168,0 6.614	230,0 9.055	185,0 7.283	45,0 1.772	182,0 7.165	14,0 0.551	140°	TiAIN	IT9
SD1112A-1429-192-16R1 SD_DRILL_9/16_12XD_A	03295166	14,288 0.563	192,0 7.559	260,0 10.236	212,0 8.346	48,0 1.890	208,0 8.189	16,0 0.630	140°	TiAIN	IT9
SD1112A-1450-192-16R1 SD_DRILL_14.5MM_12XD_A	03295167	14,5 0.571	192,0 7.559	260,0 10.236	212,0 8.346	48,0 1.890	208,0 8.189	16,0 0.630	140°	TiAIN	IT9
SD1112A-1500-192-16R1 SD_DRILL_15.0MM_12XD_A	03295168	15,0 0.591	192,0 7.559	260,0 10.236	212,0 8.346	48,0 1.890	208,0 8.189	16,0 0.630	140°	TiAIN	IT9
SD1112A-1550-192-16R1 SD_DRILL_15.5MM_12XD_A	03295169	15,5 0.610	192,0 7.559	260,0 10.236	212,0 8.346	48,0 1.890	208,0 8.189	16,0 0.630	140°	TiAIN	IT9
SD1112A-1588-192-16R1 SD_DRILL_5/8_12XD_A	03295170	15,875 0.625	192,0 7.559	260,0 10.236	212,0 8.346	48,0 1.890	208,0 8.189	16,0 0.630	140°	TiAIN	IT9
SD1112A-1600-192-16R1 SD_DRILL_16.0MM_12XD_A	03295171	16,0 0.630	192,0 7.559	260,0 10.236	212,0 8.346	48,0 1.890	208,0 8.189	16,0 0.630	140°	TiAIN	IT9
SD1112A-1650-216-18R1 SD_DRILL_16.5MM_12XD_A	03295172	16,5 0.650	216,0 8.504	285,0 11.220	237,0 9.331	48,0 1.890	234,0 9.213	18,0 0.709	140°	TiAIN	IT9
SD1112A-1700-216-18R1 SD_DRILL_17.0MM_12XD_A	03295173	17,0 0.669	216,0 8.504	285,0 11.220	237,0 9.331	48,0 1.890	234,0 9.213	18,0 0.709	140°	TiAIN	IT9
SD1112A-1750-216-18R1 SD_DRILL_17.5MM_12XD_A	03295174	17,5 0.689	216,0 8.504	285,0 11.220	237,0 9.331	48,0 1.890	234,0 9.213	18,0 0.709	140°	TiAIN	IT9
SD1112A-1800-216-18R1 SD_DRILL_18.0MM_12XD_A	03295175	18,0 0.709	216,0 8.504	285,0 11.220	237,0 9.331	48,0 1.890	234,0 9.213	18,0 0.709	140°	TiAIN	IT9
SD1112A-1900-238-20R1 SD_DRILL_19.0MM_12XD_A	03295176	19,0 0.748	238,0 9.370	310,0 12.205	260,0 10.236	50,0 1.969	258,0 10.157	20,0 0.787	140°	TiAIN	IT9
SD1112A-2000-238-20R1 SD_DRILL_20.0MM_12XD_A	03295177	20,0 0.787	238,0 9.370	310,0 12.205	260,0 10.236	50,0 1.969	258,0 10.157	20,0 0.787	140°	TiAIN	IT9

Wstęp

Wiercenie

Rozwiercanie

Wyłaczanie

Załącznik



Feedmax -P — wiertła o pojedynczej średnicy

Produkty opracowane z myślą o wysokiej wydajności i niskim koszcie na otwór, stanowiące wyjątkowe połączenie nowoczesnych gatunków węgla, powłok oraz geometrii.

- Samocentryczna geometria pozwala uzyskać wysoką jakość otworów bez potrzeby nawiercania.
- Specjalne pokrycie TiAlN zapewnia wiertłom Seco Feedmax wysoką twardość na gorąco, co w połączeniu z mocną krawędzią skrawającą przekłada się na długą i przewidywalną trwałość

SD203A-P

Głębokość wiercenia ~ 3 x D – Metryczne/Calowe

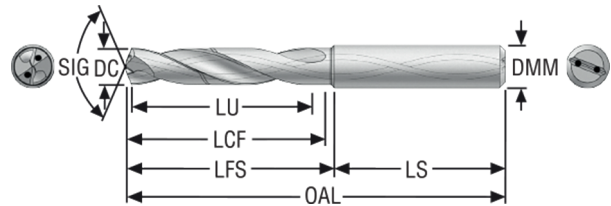

- Chwył cylindryczny DIN 6537A
- Tolerancja DC m7
- Chłodzenie wewnętrzne
- Parametry skrawania, patrz strona (strony) 144-145
- Średnice pośrednie patrz aplikacja MyDesign.

Oznaczenie	Numer produktu	DC	LU	OAL	LFS	LS	LCF	DMM	Kąt wierzchołkowy	Pokrycie	Tolerancja otworu
		mm Cal.	mm Cal.	mm Cal.	mm Cal.	mm Cal.	mm Cal.	mm Cal.			
SD203A-0200-007-04R1-P	03045918	2,0 0.079	7,0 0.276	41,0 1.614	14,0 0.551	27,0 1.063	11,0 0.433	4,0 0.157	140°	TiAIN	IT8-9
SD203A-0210-007-04R1-P	03045919	2,1 0.083	7,0 0.276	41,0 1.614	14,0 0.551	27,0 1.063	11,0 0.433	4,0 0.157	140°	TiAIN	IT8-9
SD203A-0220-007-04R1-P	03045920	2,2 0.087	7,0 0.276	41,0 1.614	14,0 0.551	27,0 1.063	11,0 0.433	4,0 0.157	140°	TiAIN	IT8-9
SD203A-0230-008-04R1-P	03045921	2,3 0.091	8,0 0.315	44,0 1.732	17,0 0.669	27,0 1.063	12,5 0.492	4,0 0.157	140°	TiAIN	IT8-9
SD203A-0235-008-04R1-P	03138154	2,35 0.093	8,0 0.315	44,0 1.732	17,0 0.669	27,0 1.063	12,5 0.492	4,0 0.157	140°	TiAIN	IT8-9
SD203A-0238-008-04R1-P	03120476	2,381 0.094	8,0 0.315	44,0 1.732	17,0 0.669	27,0 1.063	12,5 0.492	4,0 0.157	140°	TiAIN	IT8-9
SD203A-0240-008-04R1-P	03045922	2,4 0.094	8,0 0.315	44,0 1.732	17,0 0.669	27,0 1.063	12,5 0.492	4,0 0.157	140°	TiAIN	IT8-9
SD203A-0250-008-04R1-P	03045923	2,5 0.098	8,0 0.315	44,0 1.732	17,0 0.669	27,0 1.063	12,5 0.492	4,0 0.157	140°	TiAIN	IT8-9
SD203A-0260-008-04R1-P	03045924	2,6 0.102	8,0 0.315	44,0 1.732	17,0 0.669	27,0 1.063	12,5 0.492	4,0 0.157	140°	TiAIN	IT8-9
SD203A-0270-009-04R1-P	03045925	2,7 0.106	9,0 0.354	44,0 1.732	17,0 0.669	27,0 1.063	14,5 0.571	4,0 0.157	140°	TiAIN	IT8-9
SD203A-0278-009-04R1-P	03120495	2,778 0.109	9,0 0.354	44,0 1.732	17,0 0.669	27,0 1.063	14,5 0.571	4,0 0.157	140°	TiAIN	IT8-9
SD203A-0280-009-04R1-P	03045926	2,8 0.110	9,0 0.354	44,0 1.732	17,0 0.669	27,0 1.063	14,5 0.571	4,0 0.157	140°	TiAIN	IT8-9
SD203A-0290-009-04R1-P	03045927	2,9 0.114	9,0 0.354	44,0 1.732	17,0 0.669	27,0 1.063	14,5 0.571	4,0 0.157	140°	TiAIN	IT8-9
SD203A-0300-014-06R1-P	03045928	3,0 0.118	14,0 0.551	62,0 2.441	26,0 1.024	36,0 1.417	20,0 0.787	6,0 0.236	140°	TiAIN	IT8-9
SD203A-0310-014-06R1-P	03045929	3,1 0.122	14,0 0.551	62,0 2.441	26,0 1.024	36,0 1.417	20,0 0.787	6,0 0.236	140°	TiAIN	IT8-9
SD203A-0318-014-06R1-P	03046061	3,175 0.125	14,0 0.551	62,0 2.441	26,0 1.024	36,0 1.417	20,0 0.787	6,0 0.236	140°	TiAIN	IT8-9
SD203A-0320-014-06R1-P	03045930	3,2 0.126	14,0 0.551	62,0 2.441	26,0 1.024	36,0 1.417	20,0 0.787	6,0 0.236	140°	TiAIN	IT8-9
SD203A-0325-014-06R1-P	03045931	3,25 0.128	14,0 0.551	62,0 2.441	26,0 1.024	36,0 1.417	20,0 0.787	6,0 0.236	140°	TiAIN	IT8-9
SD203A-0330-014-06R1-P	03045932	3,3 0.130	14,0 0.551	62,0 2.441	26,0 1.024	36,0 1.417	20,0 0.787	6,0 0.236	140°	TiAIN	IT8-9
SD203A-0340-014-06R1-P	03045933	3,4 0.134	14,0 0.551	62,0 2.441	26,0 1.024	36,0 1.417	20,0 0.787	6,0 0.236	140°	TiAIN	IT8-9
SD203A-0350-014-06R1-P	03045934	3,5 0.138	14,0 0.551	62,0 2.441	26,0 1.024	36,0 1.417	20,0 0.787	6,0 0.236	140°	TiAIN	IT8-9
SD203A-0357-014-06R1-P	03046062	3,572 0.141	14,0 0.551	62,0 2.441	26,0 1.024	36,0 1.417	20,0 0.787	6,0 0.236	140°	TiAIN	IT8-9

Oznaczenie	Numer produktu	DC	LU	OAL	LFS	LS	LCF	DMM	Kąt wierzchołkowy	Pokrycie	Tolerancja otworu
		mm Cal.	mm Cal.	mm Cal.	mm Cal.	mm Cal.	mm Cal.	mm Cal.			
SD203A-0360-014-06R1-P	03045935	3,6 0.142	14,0 0.551	62,0 2.441	26,0 1.024	36,0 1.417	20,0 0.787	6,0 0.236	140°	TiAlN	IT8-9
SD203A-0365-014-06R1-P	03045936	3,65 0.144	14,0 0.551	62,0 2.441	26,0 1.024	36,0 1.417	20,0 0.787	6,0 0.236	140°	TiAlN	IT8-9
SD203A-0370-014-06R1-P	03045937	3,7 0.146	14,0 0.551	62,0 2.441	26,0 1.024	36,0 1.417	20,0 0.787	6,0 0.236	140°	TiAlN	IT8-9
SD203A-0380-017-06R1-P	03045938	3,8 0.150	17,0 0.669	66,0 2.598	30,0 1.181	36,0 1.417	24,0 0.945	6,0 0.236	140°	TiAlN	IT8-9
SD203A-0390-017-06R1-P	03045939	3,9 0.154	17,0 0.669	66,0 2.598	30,0 1.181	36,0 1.417	24,0 0.945	6,0 0.236	140°	TiAlN	IT8-9
SD203A-0397-017-06R1-P	03046063	3,97 0.156	17,0 0.669	66,0 2.598	30,0 1.181	36,0 1.417	24,0 0.945	6,0 0.236	140°	TiAlN	IT8-9
SD203A-0400-017-06R1-P	03045940	4,0 0.157	17,0 0.669	66,0 2.598	30,0 1.181	36,0 1.417	24,0 0.945	6,0 0.236	140°	TiAlN	IT8-9
SD203A-0410-017-06R1-P	03045941	4,1 0.161	17,0 0.669	66,0 2.598	30,0 1.181	36,0 1.417	24,0 0.945	6,0 0.236	140°	TiAlN	IT8-9
SD203A-0420-017-06R1-P	03045942	4,2 0.165	17,0 0.669	66,0 2.598	30,0 1.181	36,0 1.417	24,0 0.945	6,0 0.236	140°	TiAlN	IT8-9
SD203A-0430-017-06R1-P	03045943	4,3 0.169	17,0 0.669	66,0 2.598	30,0 1.181	36,0 1.417	24,0 0.945	6,0 0.236	140°	TiAlN	IT8-9
SD203A-0437-017-06R1-P	03046064	4,366 0.172	17,0 0.669	66,0 2.598	30,0 1.181	36,0 1.417	24,0 0.945	6,0 0.236	140°	TiAlN	IT8-9
SD203A-0450-017-06R1-P	03045944	4,5 0.177	17,0 0.669	66,0 2.598	30,0 1.181	36,0 1.417	24,0 0.945	6,0 0.236	140°	TiAlN	IT8-9
SD203A-0460-017-06R1-P	03045945	4,6 0.181	17,0 0.669	66,0 2.598	30,0 1.181	36,0 1.417	24,0 0.945	6,0 0.236	140°	TiAlN	IT8-9
SD203A-0465-017-06R1-P	03045946	4,65 0.183	17,0 0.669	66,0 2.598	30,0 1.181	36,0 1.417	24,0 0.945	6,0 0.236	140°	TiAlN	IT8-9
SD203A-0470-017-06R1-P	03045947	4,7 0.185	17,0 0.669	66,0 2.598	30,0 1.181	36,0 1.417	24,0 0.945	6,0 0.236	140°	TiAlN	IT8-9
SD203A-0476-020-06R1-P	03046065	4,763 0.188	20,0 0.787	66,0 2.598	30,0 1.181	36,0 1.417	28,0 1.102	6,0 0.236	140°	TiAlN	IT8-9
SD203A-0480-020-06R1-P	03045948	4,8 0.189	20,0 0.787	66,0 2.598	30,0 1.181	36,0 1.417	28,0 1.102	6,0 0.236	140°	TiAlN	IT8-9
SD203A-0490-020-06R1-P	03045949	4,9 0.193	20,0 0.787	66,0 2.598	30,0 1.181	36,0 1.417	28,0 1.102	6,0 0.236	140°	TiAlN	IT8-9
SD203A-0500-020-06R1-P	03045950	5,0 0.197	20,0 0.787	66,0 2.598	30,0 1.181	36,0 1.417	28,0 1.102	6,0 0.236	140°	TiAlN	IT8-9
SD203A-0510-020-06R1-P	03045951	5,1 0.201	20,0 0.787	66,0 2.598	30,0 1.181	36,0 1.417	28,0 1.102	6,0 0.236	140°	TiAlN	IT8-9
SD203A-0516-020-06R1-P	03046066	5,159 0.203	20,0 0.787	66,0 2.598	30,0 1.181	36,0 1.417	28,0 1.102	6,0 0.236	140°	TiAlN	IT8-9
SD203A-0520-020-06R1-P	03045952	5,2 0.205	20,0 0.787	66,0 2.598	30,0 1.181	36,0 1.417	28,0 1.102	6,0 0.236	140°	TiAlN	IT8-9
SD203A-0530-020-06R1-P	03045953	5,3 0.209	20,0 0.787	66,0 2.598	30,0 1.181	36,0 1.417	28,0 1.102	6,0 0.236	140°	TiAlN	IT8-9
SD203A-0540-020-06R1-P	03045954	5,4 0.213	20,0 0.787	66,0 2.598	30,0 1.181	36,0 1.417	28,0 1.102	6,0 0.236	140°	TiAlN	IT8-9
SD203A-0550-020-06R1-P	03045955	5,5 0.217	20,0 0.787	66,0 2.598	30,0 1.181	36,0 1.417	28,0 1.102	6,0 0.236	140°	TiAlN	IT8-9
SD203A-0555-020-06R1-P	03045956	5,55 0.219	20,0 0.787	66,0 2.598	30,0 1.181	36,0 1.417	28,0 1.102	6,0 0.236	140°	TiAlN	IT8-9
SD203A-0556-020-06R1-P	03046067	5,556 0.219	20,0 0.787	66,0 2.598	30,0 1.181	36,0 1.417	28,0 1.102	6,0 0.236	140°	TiAlN	IT8-9
SD203A-0560-020-06R1-P	03045957	5,6 0.220	20,0 0.787	66,0 2.598	30,0 1.181	36,0 1.417	28,0 1.102	6,0 0.236	140°	TiAlN	IT8-9
SD203A-0570-020-06R1-P	03045958	5,7 0.224	20,0 0.787	66,0 2.598	30,0 1.181	36,0 1.417	28,0 1.102	6,0 0.236	140°	TiAlN	IT8-9
SD203A-0580-020-06R1-P	03045959	5,8 0.228	20,0 0.787	66,0 2.598	30,0 1.181	36,0 1.417	28,0 1.102	6,0 0.236	140°	TiAlN	IT8-9
SD203A-0590-020-06R1-P	03045960	5,9 0.232	20,0 0.787	66,0 2.598	30,0 1.181	36,0 1.417	28,0 1.102	6,0 0.236	140°	TiAlN	IT8-9

Wstęp

Wiercenie

Rozwiercanie

Wylaczanie

Zalacznik

Oznaczenie	Numer produktu	DC	LU	OAL	LFS	LS	LCF	DMM	Kąt wierzchołkowy	Pokrycie	Tolerancja otworu
		mm Cal.	mm Cal.	mm Cal.	mm Cal.	mm Cal.	mm Cal.	mm Cal.			
SD203A-0595-020-06R1-P	03046068	5,953 0.234	20,0 0.787	66,0 2.598	30,0 1.181	36,0 1.417	28,0 1.102	6,0 0.236	140°	TiAIN	IT8-9
SD203A-0600-020-06R1-P	03045961	6,0 0.236	20,0 0.787	66,0 2.598	30,0 1.181	36,0 1.417	28,0 1.102	6,0 0.236	140°	TiAIN	IT8-9
SD203A-0610-024-08R1-P	03045962	6,1 0.240	24,0 0.945	79,0 3.110	43,0 1.693	36,0 1.417	34,0 1.339	8,0 0.315	140°	TiAIN	IT8-9
SD203A-0620-024-08R1-P	03045963	6,2 0.244	24,0 0.945	79,0 3.110	43,0 1.693	36,0 1.417	34,0 1.339	8,0 0.315	140°	TiAIN	IT8-9
SD203A-0630-024-08R1-P	03045964	6,3 0.248	24,0 0.945	79,0 3.110	43,0 1.693	36,0 1.417	34,0 1.339	8,0 0.315	140°	TiAIN	IT8-9
SD203A-0635-024-08R1-P	03046069	6,35 0.250	24,0 0.945	79,0 3.110	43,0 1.693	36,0 1.417	34,0 1.339	8,0 0.315	140°	TiAIN	IT8-9
SD203A-0640-024-08R1-P	03045965	6,4 0.252	24,0 0.945	79,0 3.110	43,0 1.693	36,0 1.417	34,0 1.339	8,0 0.315	140°	TiAIN	IT8-9
SD203A-0650-024-08R1-P	03045966	6,5 0.256	24,0 0.945	79,0 3.110	43,0 1.693	36,0 1.417	34,0 1.339	8,0 0.315	140°	TiAIN	IT8-9
SD203A-0660-024-08R1-P	03045967	6,6 0.260	24,0 0.945	79,0 3.110	43,0 1.693	36,0 1.417	34,0 1.339	8,0 0.315	140°	TiAIN	IT8-9
SD203A-0670-024-08R1-P	03045968	6,7 0.264	24,0 0.945	79,0 3.110	43,0 1.693	36,0 1.417	34,0 1.339	8,0 0.315	140°	TiAIN	IT8-9
SD203A-0675-024-08R1-P	03046070	6,747 0.266	24,0 0.945	79,0 3.110	43,0 1.693	36,0 1.417	34,0 1.339	8,0 0.315	140°	TiAIN	IT8-9
SD203A-0680-024-08R1-P	03045969	6,8 0.268	24,0 0.945	79,0 3.110	43,0 1.693	36,0 1.417	34,0 1.339	8,0 0.315	140°	TiAIN	IT8-9
SD203A-0690-024-08R1-P	03045970	6,9 0.272	24,0 0.945	79,0 3.110	43,0 1.693	36,0 1.417	34,0 1.339	8,0 0.315	140°	TiAIN	IT8-9
SD203A-0700-024-08R1-P	03045971	7,0 0.276	24,0 0.945	79,0 3.110	43,0 1.693	36,0 1.417	34,0 1.339	8,0 0.315	140°	TiAIN	IT8-9
SD203A-0710-029-08R1-P	03045972	7,1 0.280	29,0 1.142	79,0 3.110	43,0 1.693	36,0 1.417	41,0 1.614	8,0 0.315	140°	TiAIN	IT8-9
SD203A-0714-029-08R1-P	03046071	7,144 0.281	29,0 1.142	79,0 3.110	43,0 1.693	36,0 1.417	41,0 1.614	8,0 0.315	140°	TiAIN	IT8-9
SD203A-0720-029-08R1-P	03045973	7,2 0.283	29,0 1.142	79,0 3.110	43,0 1.693	36,0 1.417	41,0 1.614	8,0 0.315	140°	TiAIN	IT8-9
SD203A-0730-029-08R1-P	03045974	7,3 0.287	29,0 1.142	79,0 3.110	43,0 1.693	36,0 1.417	41,0 1.614	8,0 0.315	140°	TiAIN	IT8-9
SD203A-0740-029-08R1-P	03045975	7,4 0.291	29,0 1.142	79,0 3.110	43,0 1.693	36,0 1.417	41,0 1.614	8,0 0.315	140°	TiAIN	IT8-9
SD203A-0750-029-08R1-P	03045976	7,5 0.295	29,0 1.142	79,0 3.110	43,0 1.693	36,0 1.417	41,0 1.614	8,0 0.315	140°	TiAIN	IT8-9
SD203A-0754-029-08R1-P	03046072	7,541 0.297	29,0 1.142	79,0 3.110	43,0 1.693	36,0 1.417	41,0 1.614	8,0 0.315	140°	TiAIN	IT8-9
SD203A-0755-029-08R1-P	03045977	7,55 0.297	29,0 1.142	79,0 3.110	43,0 1.693	36,0 1.417	41,0 1.614	8,0 0.315	140°	TiAIN	IT8-9
SD203A-0760-029-08R1-P	03045978	7,6 0.299	29,0 1.142	79,0 3.110	43,0 1.693	36,0 1.417	41,0 1.614	8,0 0.315	140°	TiAIN	IT8-9
SD203A-0770-029-08R1-P	03045979	7,7 0.303	29,0 1.142	79,0 3.110	43,0 1.693	36,0 1.417	41,0 1.614	8,0 0.315	140°	TiAIN	IT8-9
SD203A-0780-029-08R1-P	03045980	7,8 0.307	29,0 1.142	79,0 3.110	43,0 1.693	36,0 1.417	41,0 1.614	8,0 0.315	140°	TiAIN	IT8-9
SD203A-0790-029-08R1-P	03045981	7,9 0.311	29,0 1.142	79,0 3.110	43,0 1.693	36,0 1.417	41,0 1.614	8,0 0.315	140°	TiAIN	IT8-9
SD203A-0794-029-08R1-P	03046073	7,938 0.313	29,0 1.142	79,0 3.110	43,0 1.693	36,0 1.417	41,0 1.614	8,0 0.315	140°	TiAIN	IT8-9
SD203A-0800-029-08R1-P	03045982	8,0 0.315	29,0 1.142	79,0 3.110	43,0 1.693	36,0 1.417	41,0 1.614	8,0 0.315	140°	TiAIN	IT8-9
SD203A-0810-035-10R1-P	03045983	8,1 0.319	35,0 1.378	89,0 3.504	49,0 1.929	40,0 1.575	47,0 1.850	10,0 0.394	140°	TiAIN	IT8-9
SD203A-0820-035-10R1-P	03045984	8,2 0.323	35,0 1.378	89,0 3.504	49,0 1.929	40,0 1.575	47,0 1.850	10,0 0.394	140°	TiAIN	IT8-9
SD203A-0830-035-10R1-P	03045985	8,3 0.327	35,0 1.378	89,0 3.504	49,0 1.929	40,0 1.575	47,0 1.850	10,0 0.394	140°	TiAIN	IT8-9

Oznaczenie	Numer produktu	DC	LU	OAL	LFS	LS	LCF	DMM	Kąt wierzchołkowy	Pokrycie	Tolerancja otworu
		mm Cal.	mm Cal.	mm Cal.	mm Cal.	mm Cal.	mm Cal.	mm Cal.			
SD203A-0833-035-10R1-P	03046074	8,334 0.328	35,0 1.378	89,0 3.504	49,0 1.929	40,0 1.575	47,0 1.850	10,0 0.394	140°	TiAlN	IT8-9
SD203A-0840-035-10R1-P	03045986	8,4 0.331	35,0 1.378	89,0 3.504	49,0 1.929	40,0 1.575	47,0 1.850	10,0 0.394	140°	TiAlN	IT8-9
SD203A-0850-035-10R1-P	03045987	8,5 0.335	35,0 1.378	89,0 3.504	49,0 1.929	40,0 1.575	47,0 1.850	10,0 0.394	140°	TiAlN	IT8-9
SD203A-0860-035-10R1-P	03045988	8,6 0.339	35,0 1.378	89,0 3.504	49,0 1.929	40,0 1.575	47,0 1.850	10,0 0.394	140°	TiAlN	IT8-9
SD203A-0870-035-10R1-P	03045989	8,7 0.343	35,0 1.378	89,0 3.504	49,0 1.929	40,0 1.575	47,0 1.850	10,0 0.394	140°	TiAlN	IT8-9
SD203A-0873-035-10R1-P	03046075	8,731 0.344	35,0 1.378	89,0 3.504	49,0 1.929	40,0 1.575	47,0 1.850	10,0 0.394	140°	TiAlN	IT8-9
SD203A-0880-035-10R1-P	03045990	8,8 0.346	35,0 1.378	89,0 3.504	49,0 1.929	40,0 1.575	47,0 1.850	10,0 0.394	140°	TiAlN	IT8-9
SD203A-0890-035-10R1-P	03045991	8,9 0.350	35,0 1.378	89,0 3.504	49,0 1.929	40,0 1.575	47,0 1.850	10,0 0.394	140°	TiAlN	IT8-9
SD203A-0900-035-10R1-P	03045992	9,0 0.354	35,0 1.378	89,0 3.504	49,0 1.929	40,0 1.575	47,0 1.850	10,0 0.394	140°	TiAlN	IT8-9
SD203A-0910-035-10R1-P	03045993	9,1 0.358	35,0 1.378	89,0 3.504	49,0 1.929	40,0 1.575	47,0 1.850	10,0 0.394	140°	TiAlN	IT8-9
SD203A-0913-035-10R1-P	03046076	9,128 0.359	35,0 1.378	89,0 3.504	49,0 1.929	40,0 1.575	47,0 1.850	10,0 0.394	140°	TiAlN	IT8-9
SD203A-0920-035-10R1-P	03045994	9,2 0.362	35,0 1.378	89,0 3.504	49,0 1.929	40,0 1.575	47,0 1.850	10,0 0.394	140°	TiAlN	IT8-9
SD203A-0930-035-10R1-P	03045995	9,3 0.366	35,0 1.378	89,0 3.504	49,0 1.929	40,0 1.575	47,0 1.850	10,0 0.394	140°	TiAlN	IT8-9
SD203A-0940-035-10R1-P	03045996	9,4 0.370	35,0 1.378	89,0 3.504	49,0 1.929	40,0 1.575	47,0 1.850	10,0 0.394	140°	TiAlN	IT8-9
SD203A-0950-035-10R1-P	03045997	9,5 0.374	35,0 1.378	89,0 3.504	49,0 1.929	40,0 1.575	47,0 1.850	10,0 0.394	140°	TiAlN	IT8-9
SD203A-0953-035-10R1-P	03046077	9,525 0.375	35,0 1.378	89,0 3.504	49,0 1.929	40,0 1.575	47,0 1.850	10,0 0.394	140°	TiAlN	IT8-9
SD203A-0955-035-10R1-P	03045998	9,55 0.376	35,0 1.378	89,0 3.504	49,0 1.929	40,0 1.575	47,0 1.850	10,0 0.394	140°	TiAlN	IT8-9
SD203A-0960-035-10R1-P	03045999	9,6 0.378	35,0 1.378	89,0 3.504	49,0 1.929	40,0 1.575	47,0 1.850	10,0 0.394	140°	TiAlN	IT8-9
SD203A-0970-035-10R1-P	03046000	9,7 0.382	35,0 1.378	89,0 3.504	49,0 1.929	40,0 1.575	47,0 1.850	10,0 0.394	140°	TiAlN	IT8-9
SD203A-0980-035-10R1-P	03046001	9,8 0.386	35,0 1.378	89,0 3.504	49,0 1.929	40,0 1.575	47,0 1.850	10,0 0.394	140°	TiAlN	IT8-9
SD203A-0990-035-10R1-P	03046002	9,9 0.390	35,0 1.378	89,0 3.504	49,0 1.929	40,0 1.575	47,0 1.850	10,0 0.394	140°	TiAlN	IT8-9
SD203A-0992-035-10R1-P	03046078	9,922 0.391	35,0 1.378	89,0 3.504	49,0 1.929	40,0 1.575	47,0 1.850	10,0 0.394	140°	TiAlN	IT8-9
SD203A-1000-035-10R1-P	03046003	10,0 0.394	35,0 1.378	89,0 3.504	49,0 1.929	40,0 1.575	47,0 1.850	10,0 0.394	140°	TiAlN	IT8-9
SD203A-1020-040-12R1-P	03046004	10,2 0.402	40,0 1.575	102,0 4.016	57,0 2.244	45,0 1.772	55,0 2.165	12,0 0.472	140°	TiAlN	IT8-9
SD203A-1032-040-12R1-P	03046079	10,319 0.406	40,0 1.575	102,0 4.016	57,0 2.244	45,0 1.772	55,0 2.165	12,0 0.472	140°	TiAlN	IT8-9
SD203A-1040-040-12R1-P	03046005	10,4 0.409	40,0 1.575	102,0 4.016	57,0 2.244	45,0 1.772	55,0 2.165	12,0 0.472	140°	TiAlN	IT8-9
SD203A-1050-040-12R1-P	03046006	10,5 0.413	40,0 1.575	102,0 4.016	57,0 2.244	45,0 1.772	55,0 2.165	12,0 0.472	140°	TiAlN	IT8-9
SD203A-1060-040-12R1-P	03046007	10,6 0.417	40,0 1.575	102,0 4.016	57,0 2.244	45,0 1.772	55,0 2.165	12,0 0.472	140°	TiAlN	IT8-9
SD203A-1072-040-12R1-P	03046080	10,716 0.422	40,0 1.575	102,0 4.016	57,0 2.244	45,0 1.772	55,0 2.165	12,0 0.472	140°	TiAlN	IT8-9
SD203A-1080-040-12R1-P	03046008	10,8 0.425	40,0 1.575	102,0 4.016	57,0 2.244	45,0 1.772	55,0 2.165	12,0 0.472	140°	TiAlN	IT8-9
SD203A-1090-040-12R1-P	03046009	10,9 0.429	40,0 1.575	102,0 4.016	57,0 2.244	45,0 1.772	55,0 2.165	12,0 0.472	140°	TiAlN	IT8-9

Wstęp

Wiercenie

Rozwiercanie

Wyłaczanie

Załącznik

Oznaczenie	Numer produktu	DC	LU	OAL	LFS	LS	LCF	DMM	Kąt wierzchołkowy	Pokrycie	Tolerancja otworu
		mm Cal.	mm Cal.	mm Cal.	mm Cal.	mm Cal.	mm Cal.	mm Cal.			
SD203A-1100-040-12R1-P	03046010	11,0 0.433	40,0 1.575	102,0 4.016	57,0 2.244	45,0 1.772	55,0 2.165	12,0 0.472	140°	TiAlN	IT8-9
SD203A-1110-040-12R1-P	03046011	11,1 0.437	40,0 1.575	102,0 4.016	57,0 2.244	45,0 1.772	55,0 2.165	12,0 0.472	140°	TiAlN	IT8-9
SD203A-1111-040-12R1-P	03046081	11,113 0.438	40,0 1.575	102,0 4.016	57,0 2.244	45,0 1.772	55,0 2.165	12,0 0.472	140°	TiAlN	IT8-9
SD203A-1120-040-12R1-P	03046012	11,2 0.441	40,0 1.575	102,0 4.016	57,0 2.244	45,0 1.772	55,0 2.165	12,0 0.472	140°	TiAlN	IT8-9
SD203A-1130-040-12R1-P	03046013	11,3 0.445	40,0 1.575	102,0 4.016	57,0 2.244	45,0 1.772	55,0 2.165	12,0 0.472	140°	TiAlN	IT8-9
SD203A-1140-040-12R1-P	03046014	11,4 0.449	40,0 1.575	102,0 4.016	57,0 2.244	45,0 1.772	55,0 2.165	12,0 0.472	140°	TiAlN	IT8-9
SD203A-1150-040-12R1-P	03046015	11,5 0.453	40,0 1.575	102,0 4.016	57,0 2.244	45,0 1.772	55,0 2.165	12,0 0.472	140°	TiAlN	IT8-9
SD203A-1151-040-12R1-P	03046082	11,509 0.453	40,0 1.575	102,0 4.016	57,0 2.244	45,0 1.772	55,0 2.165	12,0 0.472	140°	TiAlN	IT8-9
SD203A-1155-040-12R1-P	03046016	11,55 0.455	40,0 1.575	102,0 4.016	57,0 2.244	45,0 1.772	55,0 2.165	12,0 0.472	140°	TiAlN	IT8-9
SD203A-1160-040-12R1-P	03046017	11,6 0.457	40,0 1.575	102,0 4.016	57,0 2.244	45,0 1.772	55,0 2.165	12,0 0.472	140°	TiAlN	IT8-9
SD203A-1170-040-12R1-P	03046018	11,7 0.461	40,0 1.575	102,0 4.016	57,0 2.244	45,0 1.772	55,0 2.165	12,0 0.472	140°	TiAlN	IT8-9
SD203A-1180-040-12R1-P	03046019	11,8 0.465	40,0 1.575	102,0 4.016	57,0 2.244	45,0 1.772	55,0 2.165	12,0 0.472	140°	TiAlN	IT8-9
SD203A-1190-040-12R1-P	03046020	11,9 0.469	40,0 1.575	102,0 4.016	57,0 2.244	45,0 1.772	55,0 2.165	12,0 0.472	140°	TiAlN	IT8-9
SD203A-1191-040-12R1-P	03046083	11,906 0.469	40,0 1.575	102,0 4.016	57,0 2.244	45,0 1.772	55,0 2.165	12,0 0.472	140°	TiAlN	IT8-9
SD203A-1200-040-12R1-P	03046021	12,0 0.472	40,0 1.575	102,0 4.016	57,0 2.244	45,0 1.772	55,0 2.165	12,0 0.472	140°	TiAlN	IT8-9
SD203A-1210-043-14R1-P	03046022	12,1 0.476	43,0 1.693	107,0 4.213	62,0 2.441	45,0 1.772	60,0 2.362	14,0 0.551	140°	TiAlN	IT8-9
SD203A-1220-043-14R1-P	03046023	12,2 0.480	43,0 1.693	107,0 4.213	62,0 2.441	45,0 1.772	60,0 2.362	14,0 0.551	140°	TiAlN	IT8-9
SD203A-1230-043-14R1-P	03046084	12,303 0.484	43,0 1.693	107,0 4.213	62,0 2.441	45,0 1.772	60,0 2.362	14,0 0.551	140°	TiAlN	IT8-9
SD203A-1240-043-14R1-P	03046024	12,4 0.488	43,0 1.693	107,0 4.213	62,0 2.441	45,0 1.772	60,0 2.362	14,0 0.551	140°	TiAlN	IT8-9
SD203A-1250-043-14R1-P	03046025	12,5 0.492	43,0 1.693	107,0 4.213	62,0 2.441	45,0 1.772	60,0 2.362	14,0 0.551	140°	TiAlN	IT8-9
SD203A-1260-043-14R1-P	03046026	12,6 0.496	43,0 1.693	107,0 4.213	62,0 2.441	45,0 1.772	60,0 2.362	14,0 0.551	140°	TiAlN	IT8-9
SD203A-1270-043-14R1-P	03046085	12,7 0.500	43,0 1.693	107,0 4.213	62,0 2.441	45,0 1.772	60,0 2.362	14,0 0.551	140°	TiAlN	IT8-9
SD203A-1275-043-14R1-P	03046027	12,75 0.502	43,0 1.693	107,0 4.213	62,0 2.441	45,0 1.772	60,0 2.362	14,0 0.551	140°	TiAlN	IT8-9
SD203A-1280-043-14R1-P	03046028	12,8 0.504	43,0 1.693	107,0 4.213	62,0 2.441	45,0 1.772	60,0 2.362	14,0 0.551	140°	TiAlN	IT8-9
SD203A-1290-043-14R1-P	03046029	12,9 0.508	43,0 1.693	107,0 4.213	62,0 2.441	45,0 1.772	60,0 2.362	14,0 0.551	140°	TiAlN	IT8-9
SD203A-1300-043-14R1-P	03046030	13,0 0.512	43,0 1.693	107,0 4.213	62,0 2.441	45,0 1.772	60,0 2.362	14,0 0.551	140°	TiAlN	IT8-9
SD203A-1310-043-14R1-P	03046031	13,1 0.516	43,0 1.693	107,0 4.213	62,0 2.441	45,0 1.772	60,0 2.362	14,0 0.551	140°	TiAlN	IT8-9
SD203A-1320-043-14R1-P	03046032	13,2 0.520	43,0 1.693	107,0 4.213	62,0 2.441	45,0 1.772	60,0 2.362	14,0 0.551	140°	TiAlN	IT8-9
SD203A-1330-043-14R1-P	03046033	13,3 0.524	43,0 1.693	107,0 4.213	62,0 2.441	45,0 1.772	60,0 2.362	14,0 0.551	140°	TiAlN	IT8-9
SD203A-1340-043-14R1-P	03046034	13,4 0.528	43,0 1.693	107,0 4.213	62,0 2.441	45,0 1.772	60,0 2.362	14,0 0.551	140°	TiAlN	IT8-9
SD203A-1349-043-14R1-P	03046086	13,494 0.531	43,0 1.693	107,0 4.213	62,0 2.441	45,0 1.772	60,0 2.362	14,0 0.551	140°	TiAlN	IT8-9

Wstęp

Wiercenie

Rozwiercanie

Wytaczanie

Załącznik

Oznaczenie	Numer produktu	DC	LU	OAL	LFS	LS	LCF	DMM	Kąt wierzchołkowy	Pokrycie	Tolerancja otworu
		mm Cal.	mm Cal.	mm Cal.	mm Cal.	mm Cal.	mm Cal.	mm Cal.			
SD203A-1350-043-14R1-P	03046035	13,5 0.531	43,0 1.693	107,0 4.213	62,0 2.441	45,0 1.772	60,0 2.362	14,0 0.551	140°	TiAlN	IT8-9
SD203A-1360-043-14R1-P	03046036	13,6 0.535	43,0 1.693	107,0 4.213	62,0 2.441	45,0 1.772	60,0 2.362	14,0 0.551	140°	TiAlN	IT8-9
SD203A-1370-043-14R1-P	03046037	13,7 0.539	43,0 1.693	107,0 4.213	62,0 2.441	45,0 1.772	60,0 2.362	14,0 0.551	140°	TiAlN	IT8-9
SD203A-1380-043-14R1-P	03046038	13,8 0.543	43,0 1.693	107,0 4.213	62,0 2.441	45,0 1.772	60,0 2.362	14,0 0.551	140°	TiAlN	IT8-9
SD203A-1390-043-14R1-P	03046039	13,9 0.547	43,0 1.693	107,0 4.213	62,0 2.441	45,0 1.772	60,0 2.362	14,0 0.551	140°	TiAlN	IT8-9
SD203A-1400-043-14R1-P	03046040	14,0 0.551	43,0 1.693	107,0 4.213	62,0 2.441	45,0 1.772	60,0 2.362	14,0 0.551	140°	TiAlN	IT8-9
SD203A-1420-045-16R1-P	03046041	14,2 0.559	45,0 1.772	115,0 4.528	67,0 2.638	48,0 1.890	65,0 2.559	16,0 0.630	140°	TiAlN	IT8-9
SD203A-1425-045-16R1-P	03138155	14,25 0.561	45,0 1.772	115,0 4.528	67,0 2.638	48,0 1.890	65,0 2.559	16,0 0.630	140°	TiAlN	IT8-9
SD203A-1429-045-16R1-P	03046087	14,288 0.563	45,0 1.772	115,0 4.528	67,0 2.638	48,0 1.890	65,0 2.559	16,0 0.630	140°	TiAlN	IT8-9
SD203A-1450-045-16R1-P	03046042	14,5 0.571	45,0 1.772	115,0 4.528	67,0 2.638	48,0 1.890	65,0 2.559	16,0 0.630	140°	TiAlN	IT8-9
SD203A-1470-045-16R1-P	03046043	14,7 0.579	45,0 1.772	115,0 4.528	67,0 2.638	48,0 1.890	65,0 2.559	16,0 0.630	140°	TiAlN	IT8-9
SD203A-1475-045-16R1-P	03046044	14,75 0.581	45,0 1.772	115,0 4.528	67,0 2.638	48,0 1.890	65,0 2.559	16,0 0.630	140°	TiAlN	IT8-9
SD203A-1480-045-16R1-P	03046045	14,8 0.583	45,0 1.772	115,0 4.528	67,0 2.638	48,0 1.890	65,0 2.559	16,0 0.630	140°	TiAlN	IT8-9
SD203A-1500-045-16R1-P	03046046	15,0 0.591	45,0 1.772	115,0 4.528	67,0 2.638	48,0 1.890	65,0 2.559	16,0 0.630	140°	TiAlN	IT8-9
SD203A-1510-045-16R1-P	03046047	15,1 0.594	45,0 1.772	115,0 4.528	67,0 2.638	48,0 1.890	65,0 2.559	16,0 0.630	140°	TiAlN	IT8-9
SD203A-1530-045-16R1-P	03046048	15,3 0.602	45,0 1.772	115,0 4.528	67,0 2.638	48,0 1.890	65,0 2.559	16,0 0.630	140°	TiAlN	IT8-9
SD203A-1550-045-16R1-P	03046049	15,5 0.610	45,0 1.772	115,0 4.528	67,0 2.638	48,0 1.890	65,0 2.559	16,0 0.630	140°	TiAlN	IT8-9
SD203A-1570-045-16R1-P	03046050	15,7 0.618	45,0 1.772	115,0 4.528	67,0 2.638	48,0 1.890	65,0 2.559	16,0 0.630	140°	TiAlN	IT8-9
SD203A-1580-045-16R1-P	03046051	15,8 0.622	45,0 1.772	115,0 4.528	67,0 2.638	48,0 1.890	65,0 2.559	16,0 0.630	140°	TiAlN	IT8-9
SD203A-1588-045-16R1-P	03046088	15,875 0.625	45,0 1.772	115,0 4.528	67,0 2.638	48,0 1.890	65,0 2.559	16,0 0.630	140°	TiAlN	IT8-9
SD203A-1600-045-16R1-P	03046052	16,0 0.630	45,0 1.772	115,0 4.528	67,0 2.638	48,0 1.890	65,0 2.559	16,0 0.630	140°	TiAlN	IT8-9
SD203A-1650-051-18R1-P	03046053	16,5 0.650	51,0 2.008	123,0 4.843	75,0 2.953	48,0 1.890	73,0 2.874	18,0 0.709	140°	TiAlN	IT8-9
SD203A-1700-051-18R1-P	03046054	17,0 0.669	51,0 2.008	123,0 4.843	75,0 2.953	48,0 1.890	73,0 2.874	18,0 0.709	140°	TiAlN	IT8-9
SD203A-1750-051-18R1-P	03046055	17,5 0.689	51,0 2.008	123,0 4.843	75,0 2.953	48,0 1.890	73,0 2.874	18,0 0.709	140°	TiAlN	IT8-9
SD203A-1800-051-18R1-P	03046056	18,0 0.709	51,0 2.008	123,0 4.843	75,0 2.953	48,0 1.890	73,0 2.874	18,0 0.709	140°	TiAlN	IT8-9
SD203A-1850-055-20R1-P	03046057	18,5 0.728	55,0 2.165	131,0 5.157	81,0 3.189	50,0 1.969	79,0 3.110	20,0 0.787	140°	TiAlN	IT8-9
SD203A-1900-055-20R1-P	03046058	19,0 0.748	55,0 2.165	131,0 5.157	81,0 3.189	50,0 1.969	79,0 3.110	20,0 0.787	140°	TiAlN	IT8-9
SD203A-1905-055-20R1-P	03046089	19,05 0.750	55,0 2.165	131,0 5.157	81,0 3.189	50,0 1.969	79,0 3.110	20,0 0.787	140°	TiAlN	IT8-9
SD203A-1950-055-20R1-P	03046059	19,5 0.768	55,0 2.165	131,0 5.157	81,0 3.189	50,0 1.969	79,0 3.110	20,0 0.787	140°	TiAlN	IT8-9
SD203A-1980-055-20R1-P	03138156	19,8 0.780	55,0 2.165	131,0 5.157	81,0 3.189	50,0 1.969	79,0 3.110	20,0 0.787	140°	TiAlN	IT8-9
SD203A-2000-055-20R1-P	03046060	20,0 0.787	55,0 2.165	131,0 5.157	81,0 3.189	50,0 1.969	79,0 3.110	20,0 0.787	140°	TiAlN	IT8-9

Wstęp

Wiercenie

Rozwiercanie

Wylaczanie

Zalacznik

SD205A-P

Głębokość wiercenia ~ 5 x D – Metryczne/Calowe

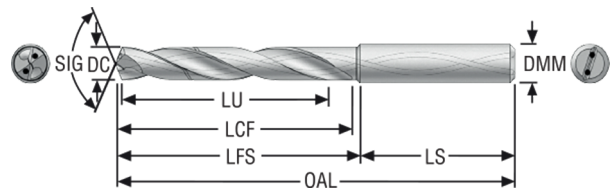

- Chwył cylindryczny DIN 6537A
- Tolerancja DC m7
- Chłodzenie wewnętrzne
- Parametry skrawania, patrz strona (strony) 146-147
- Średnice pośrednie patrz aplikacja MyDesign.

Oznaczenie	Numer produktu	DC	LU	OAL	LFS	LS	LCF	DMM	Kąt wierzchołkowy	Pokrycie	Tolerancja otworu
		mm Cal.	mm Cal.	mm Cal.	mm Cal.	mm Cal.	mm Cal.	mm Cal.			
SD205A-0200-012-04R1-P	03046131	2,0 0.079	12,0 0.472	46,0 1.811	19,0 mm 0.748	27,0 1.063	15,0 0.591	4,0 0.157	140°	TiAIN	IT8-9
SD205A-0210-012-04R1-P	03046132	2,1 0.083	12,0 0.472	46,0 1.811	19,0 mm 0.748	27,0 1.063	15,0 0.591	4,0 0.157	140°	TiAIN	IT8-9
SD205A-0220-012-04R1-P	03046133	2,2 0.087	12,0 0.472	46,0 1.811	19,0 mm 0.748	27,0 1.063	15,0 0.591	4,0 0.157	140°	TiAIN	IT8-9
SD205A-0230-012-04R1-P	03046134	2,3 0.091	12,0 0.472	46,0 1.811	19,0 mm 0.748	27,0 1.063	15,0 0.591	4,0 0.157	140°	TiAIN	IT8-9
SD205A-0238-013-04R1-P	03120477	2,381 0.094	13,0 0.512	50,0 1.969	23,0 mm 0.906	27,0 1.063	17,5 0.689	4,0 0.157	140°	TiAIN	IT8-9
SD205A-0240-013-04R1-P	03046135	2,4 0.094	13,0 0.512	50,0 1.969	23,0 mm 0.906	27,0 1.063	17,5 0.689	4,0 0.157	140°	TiAIN	IT8-9
SD205A-0250-013-04R1-P	03046136	2,5 0.098	13,0 0.512	50,0 1.969	23,0 mm 0.906	27,0 1.063	17,5 0.689	4,0 0.157	140°	TiAIN	IT8-9
SD205A-0260-013-04R1-P	03046137	2,6 0.102	13,0 0.512	50,0 1.969	23,0 mm 0.906	27,0 1.063	17,5 0.689	4,0 0.157	140°	TiAIN	IT8-9
SD205A-0270-015-04R1-P	03046138	2,7 0.106	15,0 0.591	50,0 1.969	23,0 mm 0.906	27,0 1.063	20,5 0.807	4,0 0.157	140°	TiAIN	IT8-9
SD205A-0278-015-04R1-P	03120496	2,778 0.109	15,0 0.591	50,0 1.969	23,0 mm 0.906	27,0 1.063	20,5 0.807	4,0 0.157	140°	TiAIN	IT8-9
SD205A-0280-015-04R1-P	03046139	2,8 0.110	15,0 0.591	50,0 1.969	23,0 mm 0.906	27,0 1.063	20,5 0.807	4,0 0.157	140°	TiAIN	IT8-9
SD205A-0290-015-04R1-P	03046141	2,9 0.114	15,0 0.591	50,0 1.969	23,0 mm 0.906	27,0 1.063	20,5 0.807	4,0 0.157	140°	TiAIN	IT8-9
SD205A-0300-023-06R1-P	03046142	3,0 0.118	23,0 0.906	66,0 2.598	30,0 mm 1.181	36,0 1.417	26,0 1.024	6,0 0.236	140°	TiAIN	IT8-9
SD205A-0310-023-06R1-P	03046143	3,1 0.122	23,0 0.906	66,0 2.598	30,0 mm 1.181	36,0 1.417	26,0 1.024	6,0 0.236	140°	TiAIN	IT8-9
SD205A-0318-023-06R1-P	03046327	3,175 0.125	23,0 0.906	66,0 2.598	30,0 mm 1.181	36,0 1.417	26,0 1.024	6,0 0.236	140°	TiAIN	IT8-9
SD205A-0320-023-06R1-P	03046144	3,2 0.126	23,0 0.906	66,0 2.598	30,0 mm 1.181	36,0 1.417	26,0 1.024	6,0 0.236	140°	TiAIN	IT8-9
SD205A-0325-023-06R1-P	03046145	3,25 0.128	23,0 0.906	66,0 2.598	30,0 mm 1.181	36,0 1.417	26,0 1.024	6,0 0.236	140°	TiAIN	IT8-9
SD205A-0330-023-06R1-P	03046146	3,3 0.130	23,0 0.906	66,0 2.598	30,0 mm 1.181	36,0 1.417	26,0 1.024	6,0 0.236	140°	TiAIN	IT8-9
SD205A-0340-023-06R1-P	03046147	3,4 0.134	23,0 0.906	66,0 2.598	30,0 mm 1.181	36,0 1.417	26,0 1.024	6,0 0.236	140°	TiAIN	IT8-9
SD205A-0350-023-06R1-P	03046148	3,5 0.138	23,0 0.906	66,0 2.598	30,0 mm 1.181	36,0 1.417	26,0 1.024	6,0 0.236	140°	TiAIN	IT8-9
SD205A-0357-023-06R1-P	03046328	3,572 0.141	23,0 0.906	66,0 2.598	30,0 mm 1.181	36,0 1.417	26,0 1.024	6,0 0.236	140°	TiAIN	IT8-9
SD205A-0360-023-06R1-P	03046149	3,6 0.142	23,0 0.906	66,0 2.598	30,0 mm 1.181	36,0 1.417	26,0 1.024	6,0 0.236	140°	TiAIN	IT8-9

Oznaczenie	Numer produktu	DC	LU	OAL	LFS	LS	LCF	DMM	Kąt wierzchołkowy	Pokrycie	Tolerancja otworu
		mm Cal.	mm Cal.	mm Cal.	mm Cal.	mm Cal.	mm Cal.	mm Cal.			
SD205A-0365-023-06R1-P	03046150	3,65 0.144	23,0 0.906	66,0 2.598	30,0 mm 1.181	36,0 1.417	26,0 1.024	6,0 0.236	140°	TiAlN	IT8-9
SD205A-0370-023-06R1-P	03046151	3,7 0.146	23,0 0.906	66,0 2.598	30,0 mm 1.181	36,0 1.417	26,0 1.024	6,0 0.236	140°	TiAlN	IT8-9
SD205A-0380-029-06R1-P	03046152	3,8 0.150	29,0 1.142	74,0 2.913	38,0 mm 1.496	36,0 1.417	34,0 1.339	6,0 0.236	140°	TiAlN	IT8-9
SD205A-0390-029-06R1-P	03046153	3,9 0.154	29,0 1.142	74,0 2.913	38,0 mm 1.496	36,0 1.417	34,0 1.339	6,0 0.236	140°	TiAlN	IT8-9
SD205A-0397-029-06R1-P	03046329	3,97 0.156	29,0 1.142	74,0 2.913	38,0 mm 1.496	36,0 1.417	34,0 1.339	6,0 0.236	140°	TiAlN	IT8-9
SD205A-0400-029-06R1-P	03046154	4,0 0.157	29,0 1.142	74,0 2.913	38,0 mm 1.496	36,0 1.417	34,0 1.339	6,0 0.236	140°	TiAlN	IT8-9
SD205A-0410-029-06R1-P	03046155	4,1 0.161	29,0 1.142	74,0 2.913	38,0 mm 1.496	36,0 1.417	34,0 1.339	6,0 0.236	140°	TiAlN	IT8-9
SD205A-0420-029-06R1-P	03046157	4,2 0.165	29,0 1.142	74,0 2.913	38,0 mm 1.496	36,0 1.417	34,0 1.339	6,0 0.236	140°	TiAlN	IT8-9
SD205A-0430-029-06R1-P	03046158	4,3 0.169	29,0 1.142	74,0 2.913	38,0 mm 1.496	36,0 1.417	34,0 1.339	6,0 0.236	140°	TiAlN	IT8-9
SD205A-0437-029-06R1-P	03046330	4,366 0.172	29,0 1.142	74,0 2.913	38,0 mm 1.496	36,0 1.417	34,0 1.339	6,0 0.236	140°	TiAlN	IT8-9
SD205A-0440-029-06R1-P	03046159	4,4 0.173	29,0 1.142	74,0 2.913	38,0 mm 1.496	36,0 1.417	34,0 1.339	6,0 0.236	140°	TiAlN	IT8-9
SD205A-0450-029-06R1-P	03046160	4,5 0.177	29,0 1.142	74,0 2.913	38,0 mm 1.496	36,0 1.417	34,0 1.339	6,0 0.236	140°	TiAlN	IT8-9
SD205A-0460-029-06R1-P	03046161	4,6 0.181	29,0 1.142	74,0 2.913	38,0 mm 1.496	36,0 1.417	34,0 1.339	6,0 0.236	140°	TiAlN	IT8-9
SD205A-0465-029-06R1-P	03046162	4,65 0.183	29,0 1.142	74,0 2.913	38,0 mm 1.496	36,0 1.417	34,0 1.339	6,0 0.236	140°	TiAlN	IT8-9
SD205A-0470-029-06R1-P	03046163	4,7 0.185	29,0 1.142	74,0 2.913	38,0 mm 1.496	36,0 1.417	34,0 1.339	6,0 0.236	140°	TiAlN	IT8-9
SD205A-0476-035-06R1-P	03046331	4,763 0.188	35,0 1.378	82,0 3.228	46,0 mm 1.811	36,0 1.417	44,0 1.732	6,0 0.236	140°	TiAlN	IT8-9
SD205A-0480-035-06R1-P	03046164	4,8 0.189	35,0 1.378	82,0 3.228	46,0 mm 1.811	36,0 1.417	44,0 1.732	6,0 0.236	140°	TiAlN	IT8-9
SD205A-0490-035-06R1-P	03046165	4,9 0.193	35,0 1.378	82,0 3.228	46,0 mm 1.811	36,0 1.417	44,0 1.732	6,0 0.236	140°	TiAlN	IT8-9
SD205A-0500-035-06R1-P	03046166	5,0 0.197	35,0 1.378	82,0 3.228	46,0 mm 1.811	36,0 1.417	44,0 1.732	6,0 0.236	140°	TiAlN	IT8-9
SD205A-0510-035-06R1-P	03046167	5,1 0.201	35,0 1.378	82,0 3.228	46,0 mm 1.811	36,0 1.417	44,0 1.732	6,0 0.236	140°	TiAlN	IT8-9
SD205A-0516-035-06R1-P	03046332	5,159 0.203	35,0 1.378	82,0 3.228	46,0 mm 1.811	36,0 1.417	44,0 1.732	6,0 0.236	140°	TiAlN	IT8-9
SD205A-0520-035-06R1-P	03046168	5,2 0.205	35,0 1.378	82,0 3.228	46,0 mm 1.811	36,0 1.417	44,0 1.732	6,0 0.236	140°	TiAlN	IT8-9
SD205A-0530-035-06R1-P	03046169	5,3 0.209	35,0 1.378	82,0 3.228	46,0 mm 1.811	36,0 1.417	44,0 1.732	6,0 0.236	140°	TiAlN	IT8-9
SD205A-0540-035-06R1-P	03046170	5,4 0.213	35,0 1.378	82,0 3.228	46,0 mm 1.811	36,0 1.417	44,0 1.732	6,0 0.236	140°	TiAlN	IT8-9
SD205A-0550-035-06R1-P	03046171	5,5 0.217	35,0 1.378	82,0 3.228	46,0 mm 1.811	36,0 1.417	44,0 1.732	6,0 0.236	140°	TiAlN	IT8-9
SD205A-0555-035-06R1-P	03046172	5,55 0.219	35,0 1.378	82,0 3.228	46,0 mm 1.811	36,0 1.417	44,0 1.732	6,0 0.236	140°	TiAlN	IT8-9
SD205A-0556-035-06R1-P	03046333	5,556 0.219	35,0 1.378	82,0 3.228	46,0 mm 1.811	36,0 1.417	44,0 1.732	6,0 0.236	140°	TiAlN	IT8-9
SD205A-0560-035-06R1-P	03046173	5,6 0.220	35,0 1.378	82,0 3.228	46,0 mm 1.811	36,0 1.417	44,0 1.732	6,0 0.236	140°	TiAlN	IT8-9
SD205A-0570-035-06R1-P	03046174	5,7 0.224	35,0 1.378	82,0 3.228	46,0 mm 1.811	36,0 1.417	44,0 1.732	6,0 0.236	140°	TiAlN	IT8-9
SD205A-0580-035-06R1-P	03046175	5,8 0.228	35,0 1.378	82,0 3.228	46,0 mm 1.811	36,0 1.417	44,0 1.732	6,0 0.236	140°	TiAlN	IT8-9
SD205A-0590-035-06R1-P	03046176	5,9 0.232	35,0 1.378	82,0 3.228	46,0 mm 1.811	36,0 1.417	44,0 1.732	6,0 0.236	140°	TiAlN	IT8-9

Wstęp

Wiercenie

Rozwiercanie

Wylaczanie

Załącznik

Oznaczenie	Numer produktu	DC	LU	OAL	LFS	LS	LCF	DMM	Kąt wierzchołkowy	Pokrycie	Tolerancja otworu
		mm Cal.	mm Cal.	mm Cal.	mm Cal.	mm Cal.	mm Cal.	mm Cal.			
SD205A-0595-035-06R1-P	03046334	5,953 0.234	35,0 1.378	82,0 3.228	46,0 mm 1.811	36,0 1.417	44,0 1.732	6,0 0.236	140°	TiAIN	IT8-9
SD205A-0600-035-06R1-P	03046177	6,0 0.236	35,0 1.378	82,0 3.228	46,0 mm 1.811	36,0 1.417	44,0 1.732	6,0 0.236	140°	TiAIN	IT8-9
SD205A-0610-043-08R1-P	03046179	6,1 0.240	43,0 1.693	91,0 3.583	55,0 mm 2.165	36,0 1.417	53,0 2.087	8,0 0.315	140°	TiAIN	IT8-9
SD205A-0620-043-08R1-P	03046180	6,2 0.244	43,0 1.693	91,0 3.583	55,0 mm 2.165	36,0 1.417	53,0 2.087	8,0 0.315	140°	TiAIN	IT8-9
SD205A-0630-043-08R1-P	03046181	6,3 0.248	43,0 1.693	91,0 3.583	55,0 mm 2.165	36,0 1.417	53,0 2.087	8,0 0.315	140°	TiAIN	IT8-9
SD205A-0635-043-08R1-P	03046335	6,35 0.250	43,0 1.693	91,0 3.583	55,0 mm 2.165	36,0 1.417	53,0 2.087	8,0 0.315	140°	TiAIN	IT8-9
SD205A-0640-043-08R1-P	03046182	6,4 0.252	43,0 1.693	91,0 3.583	55,0 mm 2.165	36,0 1.417	53,0 2.087	8,0 0.315	140°	TiAIN	IT8-9
SD205A-0650-043-08R1-P	03046183	6,5 0.256	43,0 1.693	91,0 3.583	55,0 mm 2.165	36,0 1.417	53,0 2.087	8,0 0.315	140°	TiAIN	IT8-9
SD205A-0660-043-08R1-P	03046184	6,6 0.260	43,0 1.693	91,0 3.583	55,0 mm 2.165	36,0 1.417	53,0 2.087	8,0 0.315	140°	TiAIN	IT8-9
SD205A-0670-043-08R1-P	03046185	6,7 0.264	43,0 1.693	91,0 3.583	55,0 mm 2.165	36,0 1.417	53,0 2.087	8,0 0.315	140°	TiAIN	IT8-9
SD205A-0675-043-08R1-P	03046336	6,747 0.266	43,0 1.693	91,0 3.583	55,0 mm 2.165	36,0 1.417	53,0 2.087	8,0 0.315	140°	TiAIN	IT8-9
SD205A-0680-043-08R1-P	03046186	6,8 0.268	43,0 1.693	91,0 3.583	55,0 mm 2.165	36,0 1.417	53,0 2.087	8,0 0.315	140°	TiAIN	IT8-9
SD205A-0690-043-08R1-P	03046187	6,9 0.272	43,0 1.693	91,0 3.583	55,0 mm 2.165	36,0 1.417	53,0 2.087	8,0 0.315	140°	TiAIN	IT8-9
SD205A-0700-043-08R1-P	03046188	7,0 0.276	43,0 1.693	91,0 3.583	55,0 mm 2.165	36,0 1.417	53,0 2.087	8,0 0.315	140°	TiAIN	IT8-9
SD205A-0710-043-08R1-P	03046190	7,1 0.280	43,0 1.693	91,0 3.583	55,0 mm 2.165	36,0 1.417	53,0 2.087	8,0 0.315	140°	TiAIN	IT8-9
SD205A-0714-043-08R1-P	03046337	7,144 0.281	43,0 1.693	91,0 3.583	55,0 mm 2.165	36,0 1.417	53,0 2.087	8,0 0.315	140°	TiAIN	IT8-9
SD205A-0720-043-08R1-P	03046191	7,2 0.283	43,0 1.693	91,0 3.583	55,0 mm 2.165	36,0 1.417	53,0 2.087	8,0 0.315	140°	TiAIN	IT8-9
SD205A-0730-043-08R1-P	03046192	7,3 0.287	43,0 1.693	91,0 3.583	55,0 mm 2.165	36,0 1.417	53,0 2.087	8,0 0.315	140°	TiAIN	IT8-9
SD205A-0740-043-08R1-P	03046193	7,4 0.291	43,0 1.693	91,0 3.583	55,0 mm 2.165	36,0 1.417	53,0 2.087	8,0 0.315	140°	TiAIN	IT8-9
SD205A-0750-043-08R1-P	03046194	7,5 0.295	43,0 1.693	91,0 3.583	55,0 mm 2.165	36,0 1.417	53,0 2.087	8,0 0.315	140°	TiAIN	IT8-9
SD205A-0754-043-08R1-P	03046338	7,541 0.297	43,0 1.693	91,0 3.583	55,0 mm 2.165	36,0 1.417	53,0 2.087	8,0 0.315	140°	TiAIN	IT8-9
SD205A-0755-043-08R1-P	03046195	7,55 0.297	43,0 1.693	91,0 3.583	55,0 mm 2.165	36,0 1.417	53,0 2.087	8,0 0.315	140°	TiAIN	IT8-9
SD205A-0760-043-08R1-P	03046196	7,6 0.299	43,0 1.693	91,0 3.583	55,0 mm 2.165	36,0 1.417	53,0 2.087	8,0 0.315	140°	TiAIN	IT8-9
SD205A-0770-043-08R1-P	03046197	7,7 0.303	43,0 1.693	91,0 3.583	55,0 mm 2.165	36,0 1.417	53,0 2.087	8,0 0.315	140°	TiAIN	IT8-9
SD205A-0780-043-08R1-P	03046198	7,8 0.307	43,0 1.693	91,0 3.583	55,0 mm 2.165	36,0 1.417	53,0 2.087	8,0 0.315	140°	TiAIN	IT8-9
SD205A-0790-043-08R1-P	03046199	7,9 0.311	43,0 1.693	91,0 3.583	55,0 mm 2.165	36,0 1.417	53,0 2.087	8,0 0.315	140°	TiAIN	IT8-9
SD205A-0794-043-08R1-P	03046339	7,938 0.313	43,0 1.693	91,0 3.583	55,0 mm 2.165	36,0 1.417	53,0 2.087	8,0 0.315	140°	TiAIN	IT8-9
SD205A-0800-043-08R1-P	03046200	8,0 0.315	43,0 1.693	91,0 3.583	55,0 mm 2.165	36,0 1.417	53,0 2.087	8,0 0.315	140°	TiAIN	IT8-9
SD205A-0810-049-10R1-P	03046201	8,1 0.319	49,0 1.929	103,0 4.055	63,0 mm 2.480	40,0 1.575	61,0 2.402	10,0 0.394	140°	TiAIN	IT8-9
SD205A-0820-049-10R1-P	03046202	8,2 0.323	49,0 1.929	103,0 4.055	63,0 mm 2.480	40,0 1.575	61,0 2.402	10,0 0.394	140°	TiAIN	IT8-9
SD205A-0830-049-10R1-P	03046203	8,3 0.327	49,0 1.929	103,0 4.055	63,0 mm 2.480	40,0 1.575	61,0 2.402	10,0 0.394	140°	TiAIN	IT8-9

Wstęp

Wiercenie

Rozwiercanie

Wyłaczanie

Załącznik

Oznaczenie	Numer produktu	DC	LU	OAL	LFS	LS	LCF	DMM	Kąt wierzchołkowy	Pokrycie	Tolerancja otworu
		mm Cal.	mm Cal.	mm Cal.	mm Cal.	mm Cal.	mm Cal.	mm Cal.			
SD205A-0833-049-10R1-P	03046340	8,334 0.328	49,0 1.929	103,0 4.055	63,0 mm 2.480	40,0 1.575	61,0 2.402	10,0 0.394	140°	TiAlN	IT8-9
SD205A-0840-049-10R1-P	03046204	8,4 0.331	49,0 1.929	103,0 4.055	63,0 mm 2.480	40,0 1.575	61,0 2.402	10,0 0.394	140°	TiAlN	IT8-9
SD205A-0850-049-10R1-P	03046205	8,5 0.335	49,0 1.929	103,0 4.055	63,0 mm 2.480	40,0 1.575	61,0 2.402	10,0 0.394	140°	TiAlN	IT8-9
SD205A-0860-049-10R1-P	03046206	8,6 0.339	49,0 1.929	103,0 4.055	63,0 mm 2.480	40,0 1.575	61,0 2.402	10,0 0.394	140°	TiAlN	IT8-9
SD205A-0870-049-10R1-P	03046207	8,7 0.343	49,0 1.929	103,0 4.055	63,0 mm 2.480	40,0 1.575	61,0 2.402	10,0 0.394	140°	TiAlN	IT8-9
SD205A-0873-049-10R1-P	03046341	8,731 0.344	49,0 1.929	103,0 4.055	63,0 mm 2.480	40,0 1.575	61,0 2.402	10,0 0.394	140°	TiAlN	IT8-9
SD205A-0880-049-10R1-P	03046208	8,8 0.346	49,0 1.929	103,0 4.055	63,0 mm 2.480	40,0 1.575	61,0 2.402	10,0 0.394	140°	TiAlN	IT8-9
SD205A-0890-049-10R1-P	03046209	8,9 0.350	49,0 1.929	103,0 4.055	63,0 mm 2.480	40,0 1.575	61,0 2.402	10,0 0.394	140°	TiAlN	IT8-9
SD205A-0900-049-10R1-P	03046210	9,0 0.354	49,0 1.929	103,0 4.055	63,0 mm 2.480	40,0 1.575	61,0 2.402	10,0 0.394	140°	TiAlN	IT8-9
SD205A-0910-049-10R1-P	03046211	9,1 0.358	49,0 1.929	103,0 4.055	63,0 mm 2.480	40,0 1.575	61,0 2.402	10,0 0.394	140°	TiAlN	IT8-9
SD205A-0913-049-10R1-P	03046342	9,128 0.359	49,0 1.929	103,0 4.055	63,0 mm 2.480	40,0 1.575	61,0 2.402	10,0 0.394	140°	TiAlN	IT8-9
SD205A-0920-049-10R1-P	03046212	9,2 0.362	49,0 1.929	103,0 4.055	63,0 mm 2.480	40,0 1.575	61,0 2.402	10,0 0.394	140°	TiAlN	IT8-9
SD205A-0930-049-10R1-P	03046213	9,3 0.366	49,0 1.929	103,0 4.055	63,0 mm 2.480	40,0 1.575	61,0 2.402	10,0 0.394	140°	TiAlN	IT8-9
SD205A-0940-049-10R1-P	03046214	9,4 0.370	49,0 1.929	103,0 4.055	63,0 mm 2.480	40,0 1.575	61,0 2.402	10,0 0.394	140°	TiAlN	IT8-9
SD205A-0950-049-10R1-P	03046215	9,5 0.374	49,0 1.929	103,0 4.055	63,0 mm 2.480	40,0 1.575	61,0 2.402	10,0 0.394	140°	TiAlN	IT8-9
SD205A-0953-049-10R1-P	03046343	9,525 0.375	49,0 1.929	103,0 4.055	63,0 mm 2.480	40,0 1.575	61,0 2.402	10,0 0.394	140°	TiAlN	IT8-9
SD205A-0955-049-10R1-P	03046216	9,55 0.376	49,0 1.929	103,0 4.055	63,0 mm 2.480	40,0 1.575	61,0 2.402	10,0 0.394	140°	TiAlN	IT8-9
SD205A-0960-049-10R1-P	03046217	9,6 0.378	49,0 1.929	103,0 4.055	63,0 mm 2.480	40,0 1.575	61,0 2.402	10,0 0.394	140°	TiAlN	IT8-9
SD205A-0970-049-10R1-P	03046218	9,7 0.382	49,0 1.929	103,0 4.055	63,0 mm 2.480	40,0 1.575	61,0 2.402	10,0 0.394	140°	TiAlN	IT8-9
SD205A-0980-049-10R1-P	03046219	9,8 0.386	49,0 1.929	103,0 4.055	63,0 mm 2.480	40,0 1.575	61,0 2.402	10,0 0.394	140°	TiAlN	IT8-9
SD205A-0990-049-10R1-P	03046220	9,9 0.390	49,0 1.929	103,0 4.055	63,0 mm 2.480	40,0 1.575	61,0 2.402	10,0 0.394	140°	TiAlN	IT8-9
SD205A-0992-049-10R1-P	03046344	9,922 0.391	49,0 1.929	103,0 4.055	63,0 mm 2.480	40,0 1.575	61,0 2.402	10,0 0.394	140°	TiAlN	IT8-9
SD205A-1000-049-10R1-P	03046221	10,0 0.394	49,0 1.929	103,0 4.055	63,0 mm 2.480	40,0 1.575	61,0 2.402	10,0 0.394	140°	TiAlN	IT8-9
SD205A-1010-056-12R1-P	03046222	10,1 0.398	56,0 2.205	118,0 4.646	73,0 mm 2.874	45,0 1.772	71,0 2.795	12,0 0.472	140°	TiAlN	IT8-9
SD205A-1020-056-12R1-P	03046223	10,2 0.402	56,0 2.205	118,0 4.646	73,0 mm 2.874	45,0 1.772	71,0 2.795	12,0 0.472	140°	TiAlN	IT8-9
SD205A-1030-056-12R1-P	03046224	10,3 0.406	56,0 2.205	118,0 4.646	73,0 mm 2.874	45,0 1.772	71,0 2.795	12,0 0.472	140°	TiAlN	IT8-9
SD205A-1032-056-12R1-P	03046345	10,319 0.406	56,0 2.205	118,0 4.646	73,0 mm 2.874	45,0 1.772	71,0 2.795	12,0 0.472	140°	TiAlN	IT8-9
SD205A-1040-056-12R1-P	03046225	10,4 0.409	56,0 2.205	118,0 4.646	73,0 mm 2.874	45,0 1.772	71,0 2.795	12,0 0.472	140°	TiAlN	IT8-9
SD205A-1050-056-12R1-P	03046226	10,5 0.413	56,0 2.205	118,0 4.646	73,0 mm 2.874	45,0 1.772	71,0 2.795	12,0 0.472	140°	TiAlN	IT8-9
SD205A-1060-056-12R1-P	03046227	10,6 0.417	56,0 2.205	118,0 4.646	73,0 mm 2.874	45,0 1.772	71,0 2.795	12,0 0.472	140°	TiAlN	IT8-9
SD205A-1070-056-12R1-P	03046228	10,7 0.421	56,0 2.205	118,0 4.646	73,0 mm 2.874	45,0 1.772	71,0 2.795	12,0 0.472	140°	TiAlN	IT8-9

Wstęp

Wiercenie

Rozwiercanie

Wyłaczanie

Załącznik

Oznaczenie	Numer produktu	DC	LU	OAL	LFS	LS	LCF	DMM	Kąt wierzchołkowy	Pokrycie	Tolerancja otworu
		mm Cal.	mm Cal.	mm Cal.	mm Cal.	mm Cal.	mm Cal.	mm Cal.			
SD205A-1072-056-12R1-P	03046346	10,716 0.422	56,0 2.205	118,0 4.646	73,0 mm 2.874	45,0 1.772	71,0 2.795	12,0 0.472	140°	TiAIN	IT8-9
SD205A-1080-056-12R1-P	03046229	10,8 0.425	56,0 2.205	118,0 4.646	73,0 mm 2.874	45,0 1.772	71,0 2.795	12,0 0.472	140°	TiAIN	IT8-9
SD205A-1090-056-12R1-P	03046230	10,9 0.429	56,0 2.205	118,0 4.646	73,0 mm 2.874	45,0 1.772	71,0 2.795	12,0 0.472	140°	TiAIN	IT8-9
SD205A-1100-056-12R1-P	03046231	11,0 0.433	56,0 2.205	118,0 4.646	73,0 mm 2.874	45,0 1.772	71,0 2.795	12,0 0.472	140°	TiAIN	IT8-9
SD205A-1110-056-12R1-P	03046232	11,1 0.437	56,0 2.205	118,0 4.646	73,0 mm 2.874	45,0 1.772	71,0 2.795	12,0 0.472	140°	TiAIN	IT8-9
SD205A-1111-056-12R1-P	03046347	11,113 0.438	56,0 2.205	118,0 4.646	73,0 mm 2.874	45,0 1.772	71,0 2.795	12,0 0.472	140°	TiAIN	IT8-9
SD205A-1120-056-12R1-P	03046233	11,2 0.441	56,0 2.205	118,0 4.646	73,0 mm 2.874	45,0 1.772	71,0 2.795	12,0 0.472	140°	TiAIN	IT8-9
SD205A-1130-056-12R1-P	03046234	11,3 0.445	56,0 2.205	118,0 4.646	73,0 mm 2.874	45,0 1.772	71,0 2.795	12,0 0.472	140°	TiAIN	IT8-9
SD205A-1140-056-12R1-P	03046235	11,4 0.449	56,0 2.205	118,0 4.646	73,0 mm 2.874	45,0 1.772	71,0 2.795	12,0 0.472	140°	TiAIN	IT8-9
SD205A-1150-056-12R1-P	03046236	11,5 0.453	56,0 2.205	118,0 4.646	73,0 mm 2.874	45,0 1.772	71,0 2.795	12,0 0.472	140°	TiAIN	IT8-9
SD205A-1151-056-12R1-P	03046348	11,509 0.453	56,0 2.205	118,0 4.646	73,0 mm 2.874	45,0 1.772	71,0 2.795	12,0 0.472	140°	TiAIN	IT8-9
SD205A-1155-056-12R1-P	03046237	11,55 0.455	56,0 2.205	118,0 4.646	73,0 mm 2.874	45,0 1.772	71,0 2.795	12,0 0.472	140°	TiAIN	IT8-9
SD205A-1160-056-12R1-P	03046238	11,6 0.457	56,0 2.205	118,0 4.646	73,0 mm 2.874	45,0 1.772	71,0 2.795	12,0 0.472	140°	TiAIN	IT8-9
SD205A-1170-056-12R1-P	03046239	11,7 0.461	56,0 2.205	118,0 4.646	73,0 mm 2.874	45,0 1.772	71,0 2.795	12,0 0.472	140°	TiAIN	IT8-9
SD205A-1180-056-12R1-P	03046240	11,8 0.465	56,0 2.205	118,0 4.646	73,0 mm 2.874	45,0 1.772	71,0 2.795	12,0 0.472	140°	TiAIN	IT8-9
SD205A-1190-056-12R1-P	03046241	11,9 0.469	56,0 2.205	118,0 4.646	73,0 mm 2.874	45,0 1.772	71,0 2.795	12,0 0.472	140°	TiAIN	IT8-9
SD205A-1191-056-12R1-P	03046349	11,906 0.469	56,0 2.205	118,0 4.646	73,0 mm 2.874	45,0 1.772	71,0 2.795	12,0 0.472	140°	TiAIN	IT8-9
SD205A-1200-056-12R1-P	03046242	12,0 0.472	56,0 2.205	118,0 4.646	73,0 mm 2.874	45,0 1.772	71,0 2.795	12,0 0.472	140°	TiAIN	IT8-9
SD205A-1210-060-14R1-P	03046243	12,1 0.476	60,0 2.362	124,0 4.882	79,0 mm 3.110	45,0 1.772	77,0 3.031	14,0 0.551	140°	TiAIN	IT8-9
SD205A-1220-060-14R1-P	03046244	12,2 0.480	60,0 2.362	124,0 4.882	79,0 mm 3.110	45,0 1.772	77,0 3.031	14,0 0.551	140°	TiAIN	IT8-9
SD205A-1225-060-14R1-P	03046245	12,25 0.482	60,0 2.362	124,0 4.882	79,0 mm 3.110	45,0 1.772	77,0 3.031	14,0 0.551	140°	TiAIN	IT8-9
SD205A-1230-060-14R1-P	03138157	12,3 0.484	60,0 2.362	124,0 4.882	79,0 mm 3.110	45,0 1.772	77,0 3.031	14,0 0.551	140°	TiAIN	IT8-9
SD205A-1240-060-14R1-P	03046246	12,4 0.488	60,0 2.362	124,0 4.882	79,0 mm 3.110	45,0 1.772	77,0 3.031	14,0 0.551	140°	TiAIN	IT8-9
SD205A-1250-060-14R1-P	03046247	12,5 0.492	60,0 2.362	124,0 4.882	79,0 mm 3.110	45,0 1.772	77,0 3.031	14,0 0.551	140°	TiAIN	IT8-9
SD205A-1260-060-14R1-P	03046248	12,6 0.496	60,0 2.362	124,0 4.882	79,0 mm 3.110	45,0 1.772	77,0 3.031	14,0 0.551	140°	TiAIN	IT8-9
SD205A-1270-060-14R1-P	03120497	12,7 0.500	60,0 2.362	124,0 4.882	79,0 mm 3.110	45,0 1.772	77,0 3.031	14,0 0.551	140°	TiAIN	IT8-9
SD205A-1275-060-14R1-P	03046249	12,75 0.502	60,0 2.362	124,0 4.882	79,0 mm 3.110	45,0 1.772	77,0 3.031	14,0 0.551	140°	TiAIN	IT8-9
SD205A-1280-060-14R1-P	03046250	12,8 0.504	60,0 2.362	124,0 4.882	79,0 mm 3.110	45,0 1.772	77,0 3.031	14,0 0.551	140°	TiAIN	IT8-9
SD205A-1290-060-14R1-P	03046251	12,9 0.508	60,0 2.362	124,0 4.882	79,0 mm 3.110	45,0 1.772	77,0 3.031	14,0 0.551	140°	TiAIN	IT8-9
SD205A-1300-060-14R1-P	03046252	13,0 0.512	60,0 2.362	124,0 4.882	79,0 mm 3.110	45,0 1.772	77,0 3.031	14,0 0.551	140°	TiAIN	IT8-9
SD205A-1310-060-14R1-P	03046253	13,1 0.516	60,0 2.362	124,0 4.882	79,0 mm 3.110	45,0 1.772	77,0 3.031	14,0 0.551	140°	TiAIN	IT8-9

Oznaczenie	Numer produktu	DC	LU	OAL	LFS	LS	LCF	DMM	Kąt wierzchołkowy	Pokrycie	Tolerancja otworu
		mm Cal.	mm Cal.	mm Cal.	mm Cal.	mm Cal.	mm Cal.	mm Cal.			
SD205A-1320-060-14R1-P	03046254	13,2 0.520	60,0 2.362	124,0 4.882	79,0 mm 3.110	45,0 1.772	77,0 3.031	14,0 0.551	140°	TiAlN	IT8-9
SD205A-1330-060-14R1-P	03046255	13,3 0.524	60,0 2.362	124,0 4.882	79,0 mm 3.110	45,0 1.772	77,0 3.031	14,0 0.551	140°	TiAlN	IT8-9
SD205A-1340-060-14R1-P	03046256	13,4 0.528	60,0 2.362	124,0 4.882	79,0 mm 3.110	45,0 1.772	77,0 3.031	14,0 0.551	140°	TiAlN	IT8-9
SD205A-1349-060-14R1-P	03046350	13,494 0.531	60,0 2.362	124,0 4.882	79,0 mm 3.110	45,0 1.772	77,0 3.031	14,0 0.551	140°	TiAlN	IT8-9
SD205A-1350-060-14R1-P	03046257	13,5 0.531	60,0 2.362	124,0 4.882	79,0 mm 3.110	45,0 1.772	77,0 3.031	14,0 0.551	140°	TiAlN	IT8-9
SD205A-1355-060-14R1-P	03138158	13,55 0.533	60,0 2.362	124,0 4.882	79,0 mm 3.110	45,0 1.772	77,0 3.031	14,0 0.551	140°	TiAlN	IT8-9
SD205A-1360-060-14R1-P	03046258	13,6 0.535	60,0 2.362	124,0 4.882	79,0 mm 3.110	45,0 1.772	77,0 3.031	14,0 0.551	140°	TiAlN	IT8-9
SD205A-1370-060-14R1-P	03046259	13,7 0.539	60,0 2.362	124,0 4.882	79,0 mm 3.110	45,0 1.772	77,0 3.031	14,0 0.551	140°	TiAlN	IT8-9
SD205A-1380-060-14R1-P	03046260	13,8 0.543	60,0 2.362	124,0 4.882	79,0 mm 3.110	45,0 1.772	77,0 3.031	14,0 0.551	140°	TiAlN	IT8-9
SD205A-1389-060-14R1-P	03120498	13,891 0.547	60,0 2.362	124,0 4.882	79,0 mm 3.110	45,0 1.772	77,0 3.031	14,0 0.551	140°	TiAlN	IT8-9
SD205A-1390-060-14R1-P	03046261	13,9 0.547	60,0 2.362	124,0 4.882	79,0 mm 3.110	45,0 1.772	77,0 3.031	14,0 0.551	140°	TiAlN	IT8-9
SD205A-1400-060-14R1-P	03046262	14,0 0.551	60,0 2.362	124,0 4.882	79,0 mm 3.110	45,0 1.772	77,0 3.031	14,0 0.551	140°	TiAlN	IT8-9
SD205A-1410-063-16R1-P	03046263	14,1 0.555	63,0 2.480	133,0 5.236	85,0 mm 3.346	48,0 1.890	83,0 3.268	16,0 0.630	140°	TiAlN	IT8-9
SD205A-1420-063-16R1-P	03046264	14,2 0.559	63,0 2.480	133,0 5.236	85,0 mm 3.346	48,0 1.890	83,0 3.268	16,0 0.630	140°	TiAlN	IT8-9
SD205A-1425-063-16R1-P	03138159	14,25 0.561	63,0 2.480	133,0 5.236	85,0 mm 3.346	48,0 1.890	83,0 3.268	16,0 0.630	140°	TiAlN	IT8-9
SD205A-1429-063-16R1-P	03046351	14,288 0.563	63,0 2.480	133,0 5.236	85,0 mm 3.346	48,0 1.890	83,0 3.268	16,0 0.630	140°	TiAlN	IT8-9
SD205A-1430-063-16R1-P	03046265	14,3 0.563	63,0 2.480	133,0 5.236	85,0 mm 3.346	48,0 1.890	83,0 3.268	16,0 0.630	140°	TiAlN	IT8-9
SD205A-1440-063-16R1-P	03046266	14,4 0.567	63,0 2.480	133,0 5.236	85,0 mm 3.346	48,0 1.890	83,0 3.268	16,0 0.630	140°	TiAlN	IT8-9
SD205A-1450-063-16R1-P	03046267	14,5 0.571	63,0 2.480	133,0 5.236	85,0 mm 3.346	48,0 1.890	83,0 3.268	16,0 0.630	140°	TiAlN	IT8-9
SD205A-1460-063-16R1-P	03046268	14,6 0.575	63,0 2.480	133,0 5.236	85,0 mm 3.346	48,0 1.890	83,0 3.268	16,0 0.630	140°	TiAlN	IT8-9
SD205A-1470-063-16R1-P	03046269	14,7 0.579	63,0 2.480	133,0 5.236	85,0 mm 3.346	48,0 1.890	83,0 3.268	16,0 0.630	140°	TiAlN	IT8-9
SD205A-1475-063-16R1-P	03046270	14,75 0.581	63,0 2.480	133,0 5.236	85,0 mm 3.346	48,0 1.890	83,0 3.268	16,0 0.630	140°	TiAlN	IT8-9
SD205A-1480-063-16R1-P	03046271	14,8 0.583	63,0 2.480	133,0 5.236	85,0 mm 3.346	48,0 1.890	83,0 3.268	16,0 0.630	140°	TiAlN	IT8-9
SD205A-1490-063-16R1-P	03046272	14,9 0.587	63,0 2.480	133,0 5.236	85,0 mm 3.346	48,0 1.890	83,0 3.268	16,0 0.630	140°	TiAlN	IT8-9
SD205A-1500-063-16R1-P	03046273	15,0 0.591	63,0 2.480	133,0 5.236	85,0 mm 3.346	48,0 1.890	83,0 3.268	16,0 0.630	140°	TiAlN	IT8-9
SD205A-1510-063-16R1-P	03046274	15,1 0.594	63,0 2.480	133,0 5.236	85,0 mm 3.346	48,0 1.890	83,0 3.268	16,0 0.630	140°	TiAlN	IT8-9
SD205A-1520-063-16R1-P	03046275	15,2 0.598	63,0 2.480	133,0 5.236	85,0 mm 3.346	48,0 1.890	83,0 3.268	16,0 0.630	140°	TiAlN	IT8-9
SD205A-1525-063-16R1-P	03138160	15,25 0.600	63,0 2.480	133,0 5.236	85,0 mm 3.346	48,0 1.890	83,0 3.268	16,0 0.630	140°	TiAlN	IT8-9
SD205A-1530-063-16R1-P	03046276	15,3 0.602	63,0 2.480	133,0 5.236	85,0 mm 3.346	48,0 1.890	83,0 3.268	16,0 0.630	140°	TiAlN	IT8-9
SD205A-1540-063-16R1-P	03046277	15,4 0.606	63,0 2.480	133,0 5.236	85,0 mm 3.346	48,0 1.890	83,0 3.268	16,0 0.630	140°	TiAlN	IT8-9
SD205A-1550-063-16R1-P	03046278	15,5 0.610	63,0 2.480	133,0 5.236	85,0 mm 3.346	48,0 1.890	83,0 3.268	16,0 0.630	140°	TiAlN	IT8-9

Wstęp

Wiercenie

Rozwiercanie

Wyłaczanie

Załącznik

Oznaczenie	Numer produktu	DC	LU	OAL	LFS	LS	LCF	DMM	Kąt wierzchołkowy	Pokrycie	Tolerancja otworu
		mm Cal.	mm Cal.	mm Cal.	mm Cal.	mm Cal.	mm Cal.	mm Cal.			
SD205A-1560-063-16R1-P	03046280	15,6 0.614	63,0 2.480	133,0 5.236	85,0 mm 3.346	48,0 1.890	83,0 3.268	16,0 0.630	140°	TiAIN	IT8-9
SD205A-1570-063-16R1-P	03046281	15,7 0.618	63,0 2.480	133,0 5.236	85,0 mm 3.346	48,0 1.890	83,0 3.268	16,0 0.630	140°	TiAIN	IT8-9
SD205A-1580-063-16R1-P	03046282	15,8 0.622	63,0 2.480	133,0 5.236	85,0 mm 3.346	48,0 1.890	83,0 3.268	16,0 0.630	140°	TiAIN	IT8-9
SD205A-1588-063-16R1-P	03046352	15,875 0.625	63,0 2.480	133,0 5.236	85,0 mm 3.346	48,0 1.890	83,0 3.268	16,0 0.630	140°	TiAIN	IT8-9
SD205A-1590-063-16R1-P	03046283	15,9 0.626	63,0 2.480	133,0 5.236	85,0 mm 3.346	48,0 1.890	83,0 3.268	16,0 0.630	140°	TiAIN	IT8-9
SD205A-1600-063-16R1-P	03046284	16,0 0.630	63,0 2.480	133,0 5.236	85,0 mm 3.346	48,0 1.890	83,0 3.268	16,0 0.630	140°	TiAIN	IT8-9
SD205A-1610-071-18R1-P	03046285	16,1 0.634	71,0 2.795	143,0 5.630	95,0 mm 3.740	48,0 1.890	93,0 3.661	18,0 0.709	140°	TiAIN	IT8-9
SD205A-1620-071-18R1-P	03046286	16,2 0.638	71,0 2.795	143,0 5.630	95,0 mm 3.740	48,0 1.890	93,0 3.661	18,0 0.709	140°	TiAIN	IT8-9
SD205A-1625-071-18R1-P	03138161	16,25 0.640	71,0 2.795	143,0 5.630	95,0 mm 3.740	48,0 1.890	93,0 3.661	18,0 0.709	140°	TiAIN	IT8-9
SD205A-1630-071-18R1-P	03046287	16,3 0.642	71,0 2.795	143,0 5.630	95,0 mm 3.740	48,0 1.890	93,0 3.661	18,0 0.709	140°	TiAIN	IT8-9
SD205A-1640-071-18R1-P	03046288	16,4 0.646	71,0 2.795	143,0 5.630	95,0 mm 3.740	48,0 1.890	93,0 3.661	18,0 0.709	140°	TiAIN	IT8-9
SD205A-1650-071-18R1-P	03046289	16,5 0.650	71,0 2.795	143,0 5.630	95,0 mm 3.740	48,0 1.890	93,0 3.661	18,0 0.709	140°	TiAIN	IT8-9
SD205A-1660-071-18R1-P	03046290	16,6 0.654	71,0 2.795	143,0 5.630	95,0 mm 3.740	48,0 1.890	93,0 3.661	18,0 0.709	140°	TiAIN	IT8-9
SD205A-1667-071-18R1-P	03120499	16,669 0.656	71,0 2.795	143,0 5.630	95,0 mm 3.740	48,0 1.890	93,0 3.661	18,0 0.709	140°	TiAIN	IT8-9
SD205A-1670-071-18R1-P	03046291	16,7 0.657	71,0 2.795	143,0 5.630	95,0 mm 3.740	48,0 1.890	93,0 3.661	18,0 0.709	140°	TiAIN	IT8-9
SD205A-1675-071-18R1-P	03046292	16,75 0.659	71,0 2.795	143,0 5.630	95,0 mm 3.740	48,0 1.890	93,0 3.661	18,0 0.709	140°	TiAIN	IT8-9
SD205A-1680-071-18R1-P	03046293	16,8 0.661	71,0 2.795	143,0 5.630	95,0 mm 3.740	48,0 1.890	93,0 3.661	18,0 0.709	140°	TiAIN	IT8-9
SD205A-1690-071-18R1-P	03046294	16,9 0.665	71,0 2.795	143,0 5.630	95,0 mm 3.740	48,0 1.890	93,0 3.661	18,0 0.709	140°	TiAIN	IT8-9
SD205A-1700-071-18R1-P	03046296	17,0 0.669	71,0 2.795	143,0 5.630	95,0 mm 3.740	48,0 1.890	93,0 3.661	18,0 0.709	140°	TiAIN	IT8-9
SD205A-1710-071-18R1-P	03046297	17,1 0.673	71,0 2.795	143,0 5.630	95,0 mm 3.740	48,0 1.890	93,0 3.661	18,0 0.709	140°	TiAIN	IT8-9
SD205A-1720-071-18R1-P	03046298	17,2 0.677	71,0 2.795	143,0 5.630	95,0 mm 3.740	48,0 1.890	93,0 3.661	18,0 0.709	140°	TiAIN	IT8-9
SD205A-1730-071-18R1-P	03046299	17,3 0.681	71,0 2.795	143,0 5.630	95,0 mm 3.740	48,0 1.890	93,0 3.661	18,0 0.709	140°	TiAIN	IT8-9
SD205A-1740-071-18R1-P	03046300	17,4 0.685	71,0 2.795	143,0 5.630	95,0 mm 3.740	48,0 1.890	93,0 3.661	18,0 0.709	140°	TiAIN	IT8-9
SD205A-1746-071-18R1-P	03120500	17,463 0.688	71,0 2.795	143,0 5.630	95,0 mm 3.740	48,0 1.890	93,0 3.661	18,0 0.709	140°	TiAIN	IT8-9
SD205A-1750-071-18R1-P	03046301	17,5 0.689	71,0 2.795	143,0 5.630	95,0 mm 3.740	48,0 1.890	93,0 3.661	18,0 0.709	140°	TiAIN	IT8-9
SD205A-1760-071-18R1-P	03046302	17,6 0.693	71,0 2.795	143,0 5.630	95,0 mm 3.740	48,0 1.890	93,0 3.661	18,0 0.709	140°	TiAIN	IT8-9
SD205A-1770-071-18R1-P	03046303	17,7 0.697	71,0 2.795	143,0 5.630	95,0 mm 3.740	48,0 1.890	93,0 3.661	18,0 0.709	140°	TiAIN	IT8-9
SD205A-1780-071-18R1-P	03046304	17,8 0.701	71,0 2.795	143,0 5.630	95,0 mm 3.740	48,0 1.890	93,0 3.661	18,0 0.709	140°	TiAIN	IT8-9
SD205A-1790-071-18R1-P	03046305	17,9 0.705	71,0 2.795	143,0 5.630	95,0 mm 3.740	48,0 1.890	93,0 3.661	18,0 0.709	140°	TiAIN	IT8-9
SD205A-1800-071-18R1-P	03046306	18,0 0.709	71,0 2.795	143,0 5.630	95,0 mm 3.740	48,0 1.890	93,0 3.661	18,0 0.709	140°	TiAIN	IT8-9
SD205A-1810-077-20R1-P	03046307	18,1 0.713	77,0 3.031	153,0 6.024	103,0 mm 4.055	50,0 1.969	101,0 3.976	20,0 0.787	140°	TiAIN	IT8-9

Wstęp

Wiercenie

Rozwiercanie

Wyłaczanie

Załącznik

Oznaczenie	Numer produktu	DC	LU	OAL	LFS	LS	LCF	DMM	Kąt wierzchołkowy	Pokrycie	Tolerancja otworu
		mm Cal.	mm Cal.	mm Cal.	mm Cal.	mm Cal.	mm Cal.	mm Cal.	mm Cal.		
SD205A-1820-077-20R1-P	03046308	18,2 0.717	77,0 3.031	153,0 6.024	103,0 mm 4.055	50,0 1.969	101,0 3.976	20,0 0.787	140°	TiAIN	IT8-9
SD205A-1830-077-20R1-P	03046309	18,3 0.720	77,0 3.031	153,0 6.024	103,0 mm 4.055	50,0 1.969	101,0 3.976	20,0 0.787	140°	TiAIN	IT8-9
SD205A-1840-077-20R1-P	03046310	18,4 0.724	77,0 3.031	153,0 6.024	103,0 mm 4.055	50,0 1.969	101,0 3.976	20,0 0.787	140°	TiAIN	IT8-9
SD205A-1850-077-20R1-P	03046311	18,5 0.728	77,0 3.031	153,0 6.024	103,0 mm 4.055	50,0 1.969	101,0 3.976	20,0 0.787	140°	TiAIN	IT8-9
SD205A-1860-077-20R1-P	03046312	18,6 0.732	77,0 3.031	153,0 6.024	103,0 mm 4.055	50,0 1.969	101,0 3.976	20,0 0.787	140°	TiAIN	IT8-9
SD205A-1870-077-20R1-P	03046313	18,7 0.736	77,0 3.031	153,0 6.024	103,0 mm 4.055	50,0 1.969	101,0 3.976	20,0 0.787	140°	TiAIN	IT8-9
SD205A-1880-077-20R1-P	03046314	18,8 0.740	77,0 3.031	153,0 6.024	103,0 mm 4.055	50,0 1.969	101,0 3.976	20,0 0.787	140°	TiAIN	IT8-9
SD205A-1890-077-20R1-P	03046315	18,9 0.744	77,0 3.031	153,0 6.024	103,0 mm 4.055	50,0 1.969	101,0 3.976	20,0 0.787	140°	TiAIN	IT8-9
SD205A-1900-077-20R1-P	03046316	19,0 0.748	77,0 3.031	153,0 6.024	103,0 mm 4.055	50,0 1.969	101,0 3.976	20,0 0.787	140°	TiAIN	IT8-9
SD205A-1905-077-20R1-P	03046353	19,05 0.750	77,0 3.031	153,0 6.024	103,0 mm 4.055	50,0 1.969	101,0 3.976	20,0 0.787	140°	TiAIN	IT8-9
SD205A-1910-077-20R1-P	03046317	19,1 0.752	77,0 3.031	153,0 6.024	103,0 mm 4.055	50,0 1.969	101,0 3.976	20,0 0.787	140°	TiAIN	IT8-9
SD205A-1920-077-20R1-P	03046318	19,2 0.756	77,0 3.031	153,0 6.024	103,0 mm 4.055	50,0 1.969	101,0 3.976	20,0 0.787	140°	TiAIN	IT8-9
SD205A-1930-077-20R1-P	03046319	19,3 0.760	77,0 3.031	153,0 6.024	103,0 mm 4.055	50,0 1.969	101,0 3.976	20,0 0.787	140°	TiAIN	IT8-9
SD205A-1940-077-20R1-P	03046320	19,4 0.764	77,0 3.031	153,0 6.024	103,0 mm 4.055	50,0 1.969	101,0 3.976	20,0 0.787	140°	TiAIN	IT8-9
SD205A-1950-077-20R1-P	03046321	19,5 0.768	77,0 3.031	153,0 6.024	103,0 mm 4.055	50,0 1.969	101,0 3.976	20,0 0.787	140°	TiAIN	IT8-9
SD205A-1960-077-20R1-P	03046322	19,6 0.772	77,0 3.031	153,0 6.024	103,0 mm 4.055	50,0 1.969	101,0 3.976	20,0 0.787	140°	TiAIN	IT8-9
SD205A-1970-077-20R1-P	03046323	19,7 0.776	77,0 3.031	153,0 6.024	103,0 mm 4.055	50,0 1.969	101,0 3.976	20,0 0.787	140°	TiAIN	IT8-9
SD205A-1980-077-20R1-P	03046324	19,8 0.780	77,0 3.031	153,0 6.024	103,0 mm 4.055	50,0 1.969	101,0 3.976	20,0 0.787	140°	TiAIN	IT8-9
SD205A-1990-077-20R1-P	03046325	19,9 0.783	77,0 3.031	153,0 6.024	103,0 mm 4.055	50,0 1.969	101,0 3.976	20,0 0.787	140°	TiAIN	IT8-9
SD205A-2000-077-20R1-P	03046326	20,0 0.787	77,0 3.031	153,0 6.024	103,0 mm 4.055	50,0 1.969	101,0 3.976	20,0 0.787	140°	TiAIN	IT8-9

SD206

Głębokość wiercenia ~ 6 x D – Metryczne/Calowe

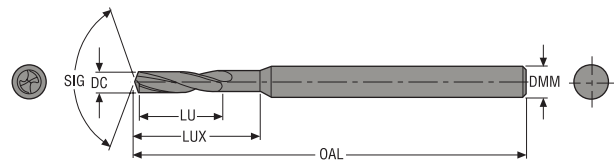

- Chwył cylindryczny
- Zewnętrzne kanały doprowadzające chłodziwo
- Parametry skrawania, patrz strona (strony) 148

Oznaczenie	Numer produktu	DC	LU	OAL	LUX	DMM	Kąt wierzchołkowy	Pokrycie	Tolerancja otworu
		mm Cal.	mm Cal.	mm Cal.	mm Cal.	mm Cal.			
SD206-0.70-4.2-3R1	02731644	0,7 0.028	4,2 0.165	38,0 1.496	6,0 0.236	3,0 0.118	140°	TiAIN	IT9
SD206-0.80-4.8-3R1	02731645	0,8 0.031	4,8 0.189	38,0 1.496	6,7 0.264	3,0 0.118	140°	TiAIN	IT9
SD206-0.90-5.4-3R1	02731646	0,9 0.035	5,4 0.213	38,0 1.496	7,8 0.307	3,0 0.118	140°	TiAIN	IT9
SD206-1.00-6.0-3R1	02731647	1,0 0.039	6,0 0.236	38,0 1.496	8,0 0.315	3,0 0.118	140°	TiAIN	IT9
SD206-1.10-6.6-3R1	02731648	1,1 0.043	6,6 0.260	38,0 1.496	8,6 0.339	3,0 0.118	140°	TiAIN	IT9
SD206-1.20-7.2-3R1	02731649	1,2 0.047	7,2 0.283	38,0 1.496	9,2 0.362	3,0 0.118	140°	TiAIN	IT9
SD206-1.30-7.8-3R1	02731650	1,3 0.051	7,8 0.307	38,0 1.496	9,8 0.386	3,0 0.118	140°	TiAIN	IT9
SD206-1.40-8.4-3R1	02731651	1,4 0.055	8,4 0.331	38,0 1.496	10,4 0.409	3,0 0.118	140°	TiAIN	IT9
SD206-1.50-9.0-3R1	02731652	1,5 0.059	9,0 0.354	38,0 1.496	11,0 0.433	3,0 0.118	140°	TiAIN	IT9
SD206-1.60-9.6-3R1	02731653	1,6 0.063	9,6 0.378	38,0 1.496	11,6 0.457	3,0 0.118	140°	TiAIN	IT9
SD206-1.70-10.2-3R1	02731654	1,7 0.067	10,2 0.402	38,0 1.496	12,2 0.480	3,0 0.118	140°	TiAIN	IT9
SD206-1.80-10.8-3R1	02731655	1,8 0.071	10,8 0.425	38,0 1.496	12,8 0.504	3,0 0.118	140°	TiAIN	IT9
SD206-1.90-11.4-3R1	02731656	1,9 0.075	11,4 0.449	38,0 1.496	13,4 0.528	3,0 0.118	140°	TiAIN	IT9
SD206-2.00-12.0-3R1	02731657	2,0 0.079	12,0 0.472	50,0 1.969	14,0 0.551	3,0 0.118	140°	TiAIN	IT9

Wstęp

Wiercenie

Rozwiercanie

Wyłaczanie

Załącznik

SD206A

Głębokość wiercenia ~ 6 x D – Metryczne/Calowe

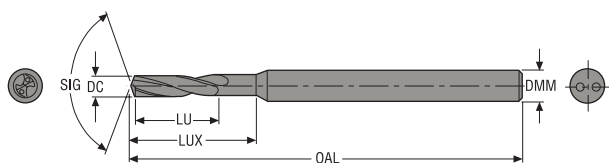

- Chwyt cylindryczny
- Chłodzenie wewnętrzne
- Parametry skrawania, patrz strona (strony) 149

Oznaczenie	Numer produktu	DC	LU	OAL	LUX	DMM	Kąt wierzchołkowy	Pokrycie	Tolerancja otworu
		mm Cal.	mm Cal.	mm Cal.	mm Cal.	mm Cal.			
SD206A-1.00-6.0-3R1	02731658	1,0 0.039	6,0 0.236	38,0 1.496	8,0 0.315	3,0 0.118	140°	TiAIN	IT9
SD206A-1.10-6.6-3R1	02731659	1,1 0.043	6,6 0.260	38,0 1.496	8,6 0.339	3,0 0.118	140°	TiAIN	IT9
SD206A-1.20-7.2-3R1	02731660	1,2 0.047	7,2 0.283	38,0 1.496	9,2 0.362	3,0 0.118	140°	TiAIN	IT9
SD206A-1.30-7.8-3R1	02731661	1,3 0.051	7,8 0.307	38,0 1.496	9,8 0.386	3,0 0.118	140°	TiAIN	IT9
SD206A-1.40-8.4-3R1	02731662	1,4 0.055	8,4 0.331	38,0 1.496	10,4 0.409	3,0 0.118	140°	TiAIN	IT9
SD206A-1.50-9.0-3R1	02731663	1,5 0.059	9,0 0.354	38,0 1.496	11,0 0.433	3,0 0.118	140°	TiAIN	IT9
SD206A-1.60-9.6-3R1	02731664	1,6 0.063	9,6 0.378	38,0 1.496	11,6 0.457	3,0 0.118	140°	TiAIN	IT9
SD206A-1.70-10.2-3R1	02731665	1,7 0.067	10,2 0.402	38,0 1.496	12,2 0.480	3,0 0.118	140°	TiAIN	IT9
SD206A-1.80-10.8-3R1	02731666	1,8 0.071	10,8 0.425	38,0 1.496	12,8 0.504	3,0 0.118	140°	TiAIN	IT9
SD206A-1.90-11.4-3R1	02731667	1,9 0.075	11,4 0.449	38,0 1.496	13,4 0.528	3,0 0.118	140°	TiAIN	IT9
SD206A-2.00-12.0-3R1	02731668	2,0 0.079	12,0 0.472	50,0 1.969	14,0 0.551	3,0 0.118	140°	TiAIN	IT9

SD207A-P

Głębokość wiercenia ~ 7 x D – Metryczne/Calowe

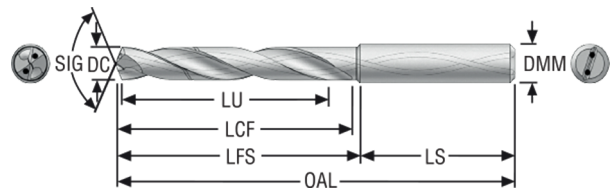

- Chwył cylindryczny DIN 6537A
- Chłodzenie wewnętrzne
- Parametry skrawania, patrz strona (strony) 150
- Średnice pośrednie patrz aplikacja MyDesign.

Oznaczenie	Numer produktu	DC	LU	OAL	LFS	LS	LCF	DMM	Kąt wierzchołkowy	Pokrycie	Tolerancja otworu
		mm Cal.	mm Cal.	mm Cal.	mm Cal.	mm Cal.	mm Cal.	mm Cal.			
SD207A-0300-030-06R1-P	03046358	3,0 0.118	30,0 1.181	74,0 2.913	38,0 1.496	36,0 1.417	36,0 1.417	6,0 0.236	140°	TiAlN	IT9
SD207A-0330-030-06R1-P	03046359	3,3 0.130	30,0 1.181	74,0 2.913	38,0 1.496	36,0 1.417	36,0 1.417	6,0 0.236	140°	TiAlN	IT9
SD207A-0350-030-06R1-P	03046360	3,5 0.138	30,0 1.181	74,0 2.913	38,0 1.496	36,0 1.417	36,0 1.417	6,0 0.236	140°	TiAlN	IT9
SD207A-0400-037-06R1-P	03046361	4,0 0.157	37,0 1.457	82,0 3.228	46,0 1.811	36,0 1.417	43,0 1.693	6,0 0.236	140°	TiAlN	IT9
SD207A-0450-037-06R1-P	03046412	4,5 0.177	37,0 1.457	82,0 3.228	46,0 1.811	36,0 1.417	43,0 1.693	6,0 0.236	140°	TiAlN	IT9
SD207A-0480-045-06R1-P	03046413	4,8 0.189	45,0 1.772	94,0 3.701	58,0 2.283	36,0 1.417	56,0 2.205	6,0 0.236	140°	TiAlN	IT9
SD207A-0500-045-06R1-P	03046414	5,0 0.197	45,0 1.772	94,0 3.701	58,0 2.283	36,0 1.417	56,0 2.205	6,0 0.236	140°	TiAlN	IT9
SD207A-0520-045-06R1-P	03046362	5,2 0.205	45,0 1.772	94,0 3.701	58,0 2.283	36,0 1.417	56,0 2.205	6,0 0.236	140°	TiAlN	IT9
SD207A-0550-045-06R1-P	03046363	5,5 0.217	45,0 1.772	94,0 3.701	58,0 2.283	36,0 1.417	56,0 2.205	6,0 0.236	140°	TiAlN	IT9
SD207A-0580-045-06R1-P	03046407	5,8 0.228	45,0 1.772	94,0 3.701	58,0 2.283	36,0 1.417	56,0 2.205	6,0 0.236	140°	TiAlN	IT9
SD207A-0600-045-06R1-P	03046364	6,0 0.236	45,0 1.772	94,0 3.701	58,0 2.283	36,0 1.417	56,0 2.205	6,0 0.236	140°	TiAlN	IT9
SD207A-0635-057-08R1-P	03046365	6,35 0.250	57,0 2.244	110,0 4.331	74,0 2.913	36,0 1.417	67,0 2.638	8,0 0.315	140°	TiAlN	IT9
SD207A-0650-057-08R1-P	03046366	6,5 0.256	57,0 2.244	110,0 4.331	74,0 2.913	36,0 1.417	67,0 2.638	8,0 0.315	140°	TiAlN	IT9
SD207A-0680-057-08R1-P	03046367	6,8 0.268	57,0 2.244	110,0 4.331	74,0 2.913	36,0 1.417	67,0 2.638	8,0 0.315	140°	TiAlN	IT9
SD207A-0690-057-08R1-P	03046368	6,9 0.272	57,0 2.244	110,0 4.331	74,0 2.913	36,0 1.417	67,0 2.638	8,0 0.315	140°	TiAlN	IT9
SD207A-0700-057-08R1-P	03046369	7,0 0.276	57,0 2.244	110,0 4.331	74,0 2.913	36,0 1.417	67,0 2.638	8,0 0.315	140°	TiAlN	IT9
SD207A-0750-057-08R1-P	03046370	7,5 0.295	57,0 2.244	110,0 4.331	74,0 2.913	36,0 1.417	72,0 2.835	8,0 0.315	140°	TiAlN	IT9
SD207A-0780-057-08R1-P	03046371	7,8 0.307	57,0 2.244	110,0 4.331	74,0 2.913	36,0 1.417	72,0 2.835	8,0 0.315	140°	TiAlN	IT9
SD207A-0800-057-08R1-P	03046372	8,0 0.315	57,0 2.244	110,0 4.331	74,0 2.913	36,0 1.417	72,0 2.835	8,0 0.315	140°	TiAlN	IT9
SD207A-0850-062-10R1-P	03046373	8,5 0.335	62,0 2.441	122,0 4.803	82,0 3.228	40,0 1.575	80,0 3.150	10,0 0.394	140°	TiAlN	IT9
SD207A-0860-062-10R1-P	03046374	8,6 0.339	62,0 2.441	122,0 4.803	82,0 3.228	40,0 1.575	80,0 3.150	10,0 0.394	140°	TiAlN	IT9
SD207A-0870-062-10R1-P	03046411	8,7 0.343	62,0 2.441	122,0 4.803	82,0 3.228	40,0 1.575	80,0 3.150	10,0 0.394	140°	TiAlN	IT9

Oznaczenie	Numer produktu	DC	LU	OAL	LFS	LS	LCF	DMM	Kąt wierzchołkowy	Pokrycie	Tolerancja otworu
		mm Cal.	mm Cal.	mm Cal.	mm Cal.	mm Cal.	mm Cal.	mm Cal.			
SD207A-0880-062-10R1-P	03046408	8,8 0.346	62,0 2.441	122,0 4.803	82,0 3.228	40,0 1.575	80,0 3.150	10,0 0.394	140°	TiAlN	IT9
SD207A-0900-062-10R1-P	03046375	9,0 0.354	62,0 2.441	122,0 4.803	82,0 3.228	40,0 1.575	80,0 3.150	10,0 0.394	140°	TiAlN	IT9
SD207A-0950-062-10R1-P	03046376	9,5 0.374	62,0 2.441	122,0 4.803	82,0 3.228	40,0 1.575	80,0 3.150	10,0 0.394	140°	TiAlN	IT9
SD207A-0953-062-10R1-P	03046377	9,525 0.375	62,0 2.441	122,0 4.803	82,0 3.228	40,0 1.575	80,0 3.150	10,0 0.394	140°	TiAlN	IT9
SD207A-0975-062-10R1-P	03046402	9,75 0.384	62,0 2.441	122,0 4.803	82,0 3.228	40,0 1.575	80,0 3.150	10,0 0.394	140°	TiAlN	IT9
SD207A-0980-062-10R1-P	03046403	9,8 0.386	62,0 2.441	122,0 4.803	82,0 3.228	40,0 1.575	80,0 3.150	10,0 0.394	140°	TiAlN	IT9
SD207A-1000-062-10R1-P	03046378	10,0 0.394	62,0 2.441	122,0 4.803	82,0 3.228	40,0 1.575	80,0 3.150	10,0 0.394	140°	TiAlN	IT9
SD207A-1020-072-12R1-P	03046379	10,2 0.402	72,0 2.835	141,0 5.551	96,0 3.780	45,0 1.772	94,0 3.701	12,0 0.472	140°	TiAlN	IT9
SD207A-1040-072-12R1-P	03046401	10,4 0.409	72,0 2.835	141,0 5.551	96,0 3.780	45,0 1.772	94,0 3.701	12,0 0.472	140°	TiAlN	IT9
SD207A-1050-072-12R1-P	03046380	10,5 0.413	72,0 2.835	141,0 5.551	96,0 3.780	45,0 1.772	94,0 3.701	12,0 0.472	140°	TiAlN	IT9
SD207A-1080-072-12R1-P	03046404	10,8 0.425	72,0 2.835	141,0 5.551	96,0 3.780	45,0 1.772	94,0 3.701	12,0 0.472	140°	TiAlN	IT9
SD207A-1100-072-12R1-P	03046381	11,0 0.433	72,0 2.835	141,0 5.551	96,0 3.780	45,0 1.772	94,0 3.701	12,0 0.472	140°	TiAlN	IT9
SD207A-1150-072-12R1-P	03046382	11,5 0.453	72,0 2.835	141,0 5.551	96,0 3.780	45,0 1.772	94,0 3.701	12,0 0.472	140°	TiAlN	IT9
SD207A-1180-072-12R1-P	03046405	11,8 0.465	72,0 2.835	141,0 5.551	96,0 3.780	45,0 1.772	94,0 3.701	12,0 0.472	140°	TiAlN	IT9
SD207A-1200-072-12R1-P	03046383	12,0 0.472	72,0 2.835	141,0 5.551	96,0 3.780	45,0 1.772	94,0 3.701	12,0 0.472	140°	TiAlN	IT9
SD207A-1225-083-14R1-P	03046415	12,25 0.482	83,0 3.268	155,0 6.102	110,0 4.331	45,0 1.772	108,0 4.252	14,0 0.551	140°	TiAlN	IT9
SD207A-1250-083-14R1-P	03046384	12,5 0.492	83,0 3.268	155,0 6.102	110,0 4.331	45,0 1.772	108,0 4.252	14,0 0.551	140°	TiAlN	IT9
SD207A-1270-083-14R1-P	03046385	12,7 0.500	83,0 3.268	155,0 6.102	110,0 4.331	45,0 1.772	108,0 4.252	14,0 0.551	140°	TiAlN	IT9
SD207A-1280-083-14R1-P	03046416	12,8 0.504	83,0 3.268	155,0 6.102	110,0 4.331	45,0 1.772	108,0 4.252	14,0 0.551	140°	TiAlN	IT9
SD207A-1300-083-14R1-P	03046386	13,0 0.512	83,0 3.268	155,0 6.102	110,0 4.331	45,0 1.772	108,0 4.252	14,0 0.551	140°	TiAlN	IT9
SD207A-1350-083-14R1-P	03046387	13,5 0.531	83,0 3.268	155,0 6.102	110,0 4.331	45,0 1.772	108,0 4.252	14,0 0.551	140°	TiAlN	IT9
SD207A-1380-083-14R1-P	03046409	13,8 0.543	83,0 3.268	155,0 6.102	110,0 4.331	45,0 1.772	108,0 4.252	14,0 0.551	140°	TiAlN	IT9
SD207A-1400-083-14R1-P	03046388	14,0 0.551	83,0 3.268	155,0 6.102	110,0 4.331	45,0 1.772	108,0 4.252	14,0 0.551	140°	TiAlN	IT9
SD207A-1425-092-16R1-P	03046417	14,25 0.561	92,0 3.622	171,0 6.732	123,0 4.843	48,0 1.890	121,0 4.764	16,0 0.630	140°	TiAlN	IT9
SD207A-1450-092-16R1-P	03046389	14,5 0.571	92,0 3.622	171,0 6.732	123,0 4.843	48,0 1.890	121,0 4.764	16,0 0.630	140°	TiAlN	IT9
SD207A-1480-092-16R1-P	03046418	14,8 0.583	92,0 3.622	171,0 6.732	123,0 4.843	48,0 1.890	121,0 4.764	16,0 0.630	140°	TiAlN	IT9
SD207A-1500-092-16R1-P	03046390	15,0 0.591	92,0 3.622	171,0 6.732	123,0 4.843	48,0 1.890	121,0 4.764	16,0 0.630	140°	TiAlN	IT9
SD207A-1550-092-16R1-P	03046391	15,5 0.610	92,0 3.622	171,0 6.732	123,0 4.843	48,0 1.890	121,0 4.764	16,0 0.630	140°	TiAlN	IT9
SD207A-1580-092-16R1-P	03046410	15,8 0.622	92,0 3.622	171,0 6.732	123,0 4.843	48,0 1.890	121,0 4.764	16,0 0.630	140°	TiAlN	IT9
SD207A-1600-092-16R1-P	03046392	16,0 0.630	92,0 3.622	171,0 6.732	123,0 4.843	48,0 1.890	121,0 4.764	16,0 0.630	140°	TiAlN	IT9
SD207A-1650-103-18R1-P	03046393	16,5 0.650	103,0 4.055	185,0 7.283	137,0 5.394	48,0 1.890	135,0 5.315	18,0 0.709	140°	TiAlN	IT9

Wstęp

Wiercenie

Rozwiercanie

Wytaczanie

Załącznik

Oznaczenie	Numer produktu	DC	LU	OAL	LFS	LS	LCF	DMM	Kąt wierzchołkowy	Pokrycie	Tolerancja otworu
		mm Cal.	mm Cal.	mm Cal.	mm Cal.	mm Cal.	mm Cal.	mm Cal.	mm Cal.		
SD207A-1680-103-18R1-P	03046419	16,8 0.661	103,0 4.055	185,0 7.283	137,0 5.394	48,0 1.890	135,0 5.315	18,0 0.709	140°	TiAIN	IT9
SD207A-1700-103-18R1-P	03046394	17,0 0.669	103,0 4.055	185,0 7.283	137,0 5.394	48,0 1.890	135,0 5.315	18,0 0.709	140°	TiAIN	IT9
SD207A-1750-103-18R1-P	03046395	17,5 0.689	103,0 4.055	185,0 7.283	137,0 5.394	48,0 1.890	135,0 5.315	18,0 0.709	140°	TiAIN	IT9
SD207A-1780-103-18R1-P	03046420	17,8 0.701	103,0 4.055	185,0 7.283	137,0 5.394	48,0 1.890	135,0 5.315	18,0 0.709	140°	TiAIN	IT9
SD207A-1800-103-18R1-P	03046396	18,0 0.709	103,0 4.055	185,0 7.283	137,0 5.394	48,0 1.890	135,0 5.315	18,0 0.709	140°	TiAIN	IT9
SD207A-1850-112-20R1-P	03046397	18,5 0.728	112,0 4.409	200,0 7.874	150,0 5.906	50,0 1.969	148,0 5.827	20,0 0.787	140°	TiAIN	IT9
SD207A-1880-112-20R1-P	03046421	18,8 0.740	112,0 4.409	200,0 7.874	150,0 5.906	50,0 1.969	148,0 5.827	20,0 0.787	140°	TiAIN	IT9
SD207A-1900-112-20R1-P	03046398	19,0 0.748	112,0 4.409	200,0 7.874	150,0 5.906	50,0 1.969	148,0 5.827	20,0 0.787	140°	TiAIN	IT9
SD207A-1905-112-20R1-P	03046399	19,05 0.750	112,0 4.409	200,0 7.874	150,0 5.906	50,0 1.969	148,0 5.827	20,0 0.787	140°	TiAIN	IT9
SD207A-1980-112-20R1-P	03046406	19,8 0.780	112,0 4.409	200,0 7.874	150,0 5.906	50,0 1.969	148,0 5.827	20,0 0.787	140°	TiAIN	IT9
SD207A-2000-112-20R1-P	03046400	20,0 0.787	112,0 4.409	200,0 7.874	150,0 5.906	50,0 1.969	148,0 5.827	20,0 0.787	140°	TiAIN	IT9

Wstęp

Wiercenie

Rozwiercanie

Wytaczanie

Załącznik

SD216A

Głębokość wiercenia ~ 16 x D – Metryczne/Calowe

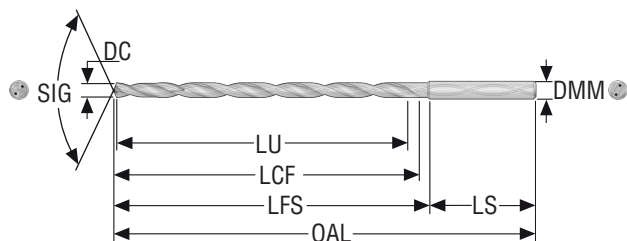

- Chwyt cylindryczny DIN 6537A
- Chłodzenie wewnętrzne
- Parametry skrawania, patrz strona (strony) 151
- Średnice pośrednie patrz aplikacja MyDesign.

Oznaczenie	Numer produktu	DC	LU	OAL	LFS	LS	LCF	DMM	Kąt wierzchołkowy	Pokrycie	Tolerancja otworu
		mm Cal.	mm Cal.	mm Cal.	mm Cal.	mm Cal.	mm Cal.	mm Cal.			
SD216A-3.0-50-4R1	02712383	3,0 0.118	50,0 1.969	88,0 3.465	61,0 2.402	27,0 1.063	56,0 2.205	4,0 0.157	136°	TiAIN + TiN	IT9
SD216A-3.5-60-4R1	02712384	3,5 0.138	60,0 2.362	99,0 3.898	72,0 2.835	27,0 1.063	67,0 2.638	4,0 0.157	136°	TiAIN + TiN	IT9
SD216A-4.0-60-4R1	02712385	4,0 0.157	60,0 2.362	99,0 3.898	72,0 2.835	27,0 1.063	67,0 2.638	4,0 0.157	136°	TiAIN + TiN	IT9
SD216A-4.5-70-6R1	02712386	4,5 0.177	70,0 2.756	117,0 4.606	81,0 3.189	36,0 1.417	79,0 3.110	6,0 0.236	136°	TiAIN + TiN	IT9
SD216A-5.0-90-6R1	02637529	5,0 0.197	90,0 3.543	142,0 5.591	106,0 4.173	36,0 1.417	103,0 4.055	6,0 0.236	136°	TiAIN + TiN	IT9
SD216A-5.5-90-6R1	02637530	5,5 0.217	90,0 3.543	142,0 5.591	106,0 4.173	36,0 1.417	103,0 4.055	6,0 0.236	136°	TiAIN + TiN	IT9
SD216A-6.0-90-6R1	02637531	6,0 0.236	90,0 3.543	142,0 5.591	106,0 4.173	36,0 1.417	103,0 4.055	6,0 0.236	136°	TiAIN + TiN	IT9
SD216A-6.35-120-8R1	02656536	6,35 0.250	120,0 4.724	177,0 6.969	141,0 5.551	36,0 1.417	137,0 5.394	8,0 0.315	136°	TiAIN + TiN	IT9
SD216A-6.5-120-8R1	02637532	6,5 0.256	120,0 4.724	177,0 6.969	141,0 5.551	36,0 1.417	137,0 5.394	8,0 0.315	136°	TiAIN + TiN	IT9
SD216A-7.0-120-8R1	02637533	7,0 0.276	120,0 4.724	177,0 6.969	141,0 5.551	36,0 1.417	137,0 5.394	8,0 0.315	136°	TiAIN + TiN	IT9
SD216A-7.5-120-8R1	02637534	7,5 0.295	120,0 4.724	177,0 6.969	141,0 5.551	36,0 1.417	137,0 5.394	8,0 0.315	136°	TiAIN + TiN	IT9
SD216A-8.0-120-8R1	02637536	8,0 0.315	120,0 4.724	177,0 6.969	141,0 5.551	36,0 1.417	137,0 5.394	8,0 0.315	136°	TiAIN + TiN	IT9
SD216A-8.5-150-10R1	02637539	8,5 0.335	150,0 5.906	216,0 8.504	176,0 6.929	40,0 1.575	172,0 6.772	10,0 0.394	136°	TiAIN + TiN	IT9
SD216A-9.0-150-10R1	02637540	9,0 0.354	150,0 5.906	216,0 8.504	176,0 6.929	40,0 1.575	172,0 6.772	10,0 0.394	136°	TiAIN + TiN	IT9
SD216A-9.5-150-10R1	02637541	9,5 0.374	150,0 5.906	216,0 8.504	176,0 6.929	40,0 1.575	172,0 6.772	10,0 0.394	136°	TiAIN + TiN	IT9
SD216A-9.52-150-10R1	02656537	9,52 0.375	150,0 5.906	216,0 8.504	176,0 6.929	40,0 1.575	172,0 6.772	10,0 0.394	136°	TiAIN + TiN	IT9
SD216A-10.0-150-10R1	02637542	10,0 0.394	150,0 5.906	216,0 8.504	176,0 6.929	40,0 1.575	172,0 6.772	10,0 0.394	136°	TiAIN + TiN	IT9
SD216A-10.5-180-12R1	02637543	10,5 0.413	180,0 7.087	256,0 10.079	211,0 8.307	45,0 1.772	207,0 8.150	12,0 0.472	136°	TiAIN + TiN	IT9
SD216A-11.0-180-12R1	02637544	11,0 0.433	180,0 7.087	256,0 10.079	211,0 8.307	45,0 1.772	207,0 8.150	12,0 0.472	136°	TiAIN + TiN	IT9
SD216A-11.5-180-12R1	02637545	11,5 0.453	180,0 7.087	256,0 10.079	211,0 8.307	45,0 1.772	207,0 8.150	12,0 0.472	136°	TiAIN + TiN	IT9
SD216A-12.0-180-12R1	02637546	12,0 0.472	180,0 7.087	256,0 10.079	211,0 8.307	45,0 1.772	207,0 8.150	12,0 0.472	136°	TiAIN + TiN	IT9

SD230A

Głębokość wiercenia ~ 30 x D – Metryczne/Calowe

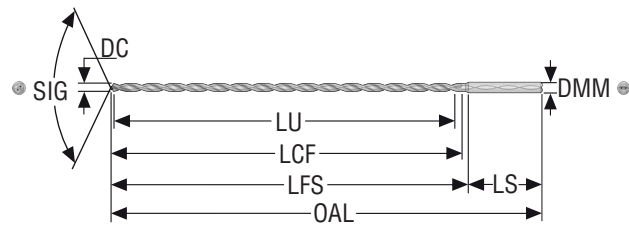

- Chwył cylindryczny DIN 6537A
- Chłodzenie wewnętrzne
- Parametry skrawania, patrz strona (strony) 152
- Średnice pośrednie patrz aplikacja MyDesign.

Oznaczenie	Numer produktu	DC	LU	OAL	LFS	LS	LCF	DMM	Kąt wierzchołkowy	Pokrycie	Tolerancja otworu
		mm Cal.	mm Cal.	mm Cal.	mm Cal.	mm Cal.	mm Cal.	mm Cal.			
SD230A-4.0-112-4R1	02712361	4,0 0.157	112,0 4.409	151,0 5.945	124,0 4.882	27,0 1.063	119,0 4.685	4,0 0.157	136°	TiAIN + TiN	IT9
SD230A-4.5-135-6R1	02712362	4,5 0.177	135,0 5.315	185,0 7.283	149,0 5.866	36,0 1.417	145,0 5.709	6,0 0.236	136°	TiAIN + TiN	IT9
SD230A-5.0-170-6R1	02712363	5,0 0.197	170,0 6.693	220,0 8.661	184,0 7.244	36,0 1.417	180,0 7.087	6,0 0.236	136°	TiAIN + TiN	IT9
SD230A-5.5-170-6R1	02712364	5,5 0.217	170,0 6.693	220,0 8.661	184,0 7.244	36,0 1.417	180,0 7.087	6,0 0.236	136°	TiAIN + TiN	IT9
SD230A-6.0-170-6R1	02712365	6,0 0.236	170,0 6.693	220,0 8.661	184,0 7.244	36,0 1.417	180,0 7.087	6,0 0.236	136°	TiAIN + TiN	IT9
SD230A-02500-886-0315R1	02712366	6,35 0.250	225,0 8.858	279,0 10.984	243,0 9.567	36,0 1.417	239,0 9.409	8,0 0.315	136°	TiAIN + TiN	IT9
SD230A-6.5-225-8R1	02712367	6,5 0.256	225,0 8.858	279,0 10.984	243,0 9.567	36,0 1.417	239,0 9.409	8,0 0.315	136°	TiAIN + TiN	IT9
SD230A-7.0-225-8R1	02712370	7,0 0.276	225,0 8.858	279,0 10.984	243,0 9.567	36,0 1.417	239,0 9.409	8,0 0.315	136°	TiAIN + TiN	IT9
SD230A-7.5-225-8R1	02712371	7,5 0.295	225,0 8.858	279,0 10.984	243,0 9.567	36,0 1.417	239,0 9.409	8,0 0.315	136°	TiAIN + TiN	IT9
SD230A-03125-886-0315R1	02712374	7,938 0.313	225,0 8.858	279,0 10.984	243,0 9.567	36,0 1.417	239,0 9.409	8,0 0.315	136°	TiAIN + TiN	IT9
SD230A-8.0-225-8R1	02712376	8,0 0.315	225,0 8.858	279,0 10.984	243,0 9.567	36,0 1.417	239,0 9.409	8,0 0.315	136°	TiAIN + TiN	IT9
SD230A-8.5-285-10R1	02712378	8,5 0.335	285,0 11.220	346,0 13.622	306,0 12.047	40,0 1.575	302,0 11.890	10,0 0.394	136°	TiAIN + TiN	IT9
SD230A-9.0-285-10R1	02712379	9,0 0.354	285,0 11.220	346,0 13.622	306,0 12.047	40,0 1.575	302,0 11.890	10,0 0.394	136°	TiAIN + TiN	IT9
SD230A-9.5-285-10R1	02712380	9,5 0.374	285,0 11.220	346,0 13.622	306,0 12.047	40,0 1.575	302,0 11.890	10,0 0.394	136°	TiAIN + TiN	IT9
SD230A-03750-1122-0394R1	02712381	9,525 0.375	285,0 11.220	346,0 13.622	306,0 12.047	40,0 1.575	302,0 11.890	10,0 0.394	136°	TiAIN + TiN	IT9
SD230A-10.0-285-10R1	02712382	10,0 0.394	285,0 11.220	346,0 13.622	306,0 12.047	40,0 1.575	302,0 11.890	10,0 0.394	136°	TiAIN + TiN	IT9



Feedmax™ SD245A

Wiertła Seco Feedmax SD245A z węglików spiekanych to gwarancja doskonałej stabilności i większej wydajności obróbki w operacjach wykonywania otworów o nieregularnym wylocie oraz otworów krzyżujących się. Następujące cechy pozwalają uzyskać dobrą geometrię otworu:

- Cztery łysinki
- Zoptymalizowany punkt samocentrujący
- Powłoka TiAlN+TiN o wysokiej odporności na ścieranie
- Lepsze zabezpieczenie krawędzi

SD245A

Głębokość wiercenia ~ 5 x D – Metryczne/Calowe

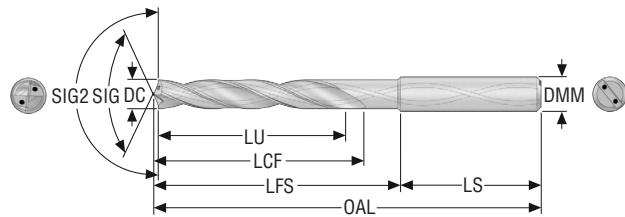

- Chwyt cylindryczny DIN 6537A
- Chłodzenie wewnętrzne
- Parametry skrawania, patrz strona (strony) 153
- Średnice pośrednie patrz aplikacja MyDesign.

Oznaczenie	Numer produktu	DC	LU	OAL	LFS	LS	LCF	DMM	Kąt wierzchołkowy	Pokrycie	Tolerancja otworu
		mm Cal.	mm Cal.	mm Cal.	mm Cal.	mm Cal.	mm Cal.	mm Cal.			
SD245A-5.0-32-6R1	02691683	5,0 0.197	32,0 1.260	82,0 3.228	46,0 1.811	36,0 1.417	44,0 1.732	6,0 0.236	140°/180°	TiAIN + TiN	IT8
SD245A-6.0-32-6R1	02691684	6,0 0.236	32,0 1.260	82,0 3.228	46,0 1.811	36,0 1.417	44,0 1.732	6,0 0.236	140°/180°	TiAIN + TiN	IT8
SD245A-02500-138-0315R1	02691686	6,35 0.2500	35,0 1.378	91,0 3.583	55,0 2.165	36,0 1.417	53,0 2.087	8,0 0.315	140°/180°	TiAIN + TiN	IT8
SD245A-6.5-35-8R1	02691687	6,5 0.256	35,0 1.378	91,0 3.583	55,0 2.165	36,0 1.417	53,0 2.087	8,0 0.315	140°/180°	TiAIN + TiN	IT8
SD245A-02656-157-0315R1	02691688	6,747 0.2656	40,0 1.575	91,0 3.583	55,0 2.165	36,0 1.417	53,0 2.087	8,0 0.315	140°/180°	TiAIN + TiN	IT8
SD245A-6.8-40-8R1	02691689	6,8 0.268	40,0 1.575	91,0 3.583	55,0 2.165	36,0 1.417	53,0 2.087	8,0 0.315	140°/180°	TiAIN + TiN	IT8
SD245A-7.0-40-8R1	02691690	7,0 0.276	40,0 1.575	91,0 3.583	55,0 2.165	36,0 1.417	53,0 2.087	8,0 0.315	140°/180°	TiAIN + TiN	IT8
SD245A-02813-157-0315R1	02691691	7,144 0.2813	40,0 1.575	91,0 3.583	55,0 2.165	36,0 1.417	53,0 2.087	8,0 0.315	140°/180°	TiAIN + TiN	IT8
SD245A-7.5-40-8R1	02691692	7,5 0.295	40,0 1.575	91,0 3.583	55,0 2.165	36,0 1.417	53,0 2.087	8,0 0.315	140°/180°	TiAIN + TiN	IT8
SD245A-03125-165-0315R1	02691693	7,938 0.3125	42,0 1.654	91,0 3.583	55,0 2.165	36,0 1.417	53,0 2.087	8,0 0.315	140°/180°	TiAIN + TiN	IT8
SD245A-8.0-42-8R1	02691694	8,0 0.315	42,0 1.654	91,0 3.583	55,0 2.165	36,0 1.417	53,0 2.087	8,0 0.315	140°/180°	TiAIN + TiN	IT8
SD245A-8.5-42-10R1	02691695	8,5 0.335	42,0 1.654	103,0 4.055	63,0 2.480	40,0 1.575	61,0 2.402	10,0 0.394	140°/180°	TiAIN + TiN	IT8
SD245A-9.0-45-10R1	02546059	9,0 0.354	45,0 1.772	103,0 4.055	63,0 2.480	40,0 1.575	61,0 2.402	10,0 0.394	140°/180°	TiAIN + TiN	IT8
SD245A-9.5-45-10R1	02691696	9,5 0.374	45,0 1.772	103,0 4.055	63,0 2.480	40,0 1.575	61,0 2.402	10,0 0.394	140°/180°	TiAIN + TiN	IT8
SD245A-03750-189-0394R1	02691697	9,525 0.3750	48,0 1.890	103,0 4.055	63,0 2.480	40,0 1.575	61,0 2.402	10,0 0.394	140°/180°	TiAIN + TiN	IT8
SD245A-10.0-48-10R1	02536888	10,0 0.394	48,0 1.890	103,0 4.055	63,0 2.480	40,0 1.575	61,0 2.402	10,0 0.394	140°/180°	TiAIN + TiN	IT8
SD245A-10.2-48-12R1	02691699	10,2 0.402	48,0 1.890	118,0 4.646	73,0 2.874	45,0 1.772	71,0 2.795	12,0 0.472	140°/180°	TiAIN + TiN	IT8
SD245A-04063-189-0472R1	02691700	10,319 0.4063	48,0 1.890	118,0 4.646	73,0 2.874	45,0 1.772	71,0 2.795	12,0 0.472	140°/180°	TiAIN + TiN	IT8
SD245A-10.5-48-12R1	02691701	10,5 0.413	48,0 1.890	118,0 4.646	73,0 2.874	45,0 1.772	71,0 2.795	12,0 0.472	140°/180°	TiAIN + TiN	IT8
SD245A-11.0-56-12R1	02561860	11,0 0.433	56,0 2.205	118,0 4.646	73,0 2.874	45,0 1.772	71,0 2.795	12,0 0.472	140°/180°	TiAIN + TiN	IT8
SD245A-04375-221-0472R1	02691702	11,113 0.4375	56,0 2.205	118,0 4.646	73,0 2.874	45,0 1.772	71,0 2.795	12,0 0.472	140°/180°	TiAIN + TiN	IT8
SD245A-11.5-56-12R1	02691704	11,5 0.453	56,0 2.205	118,0 4.646	73,0 2.874	45,0 1.772	71,0 2.795	12,0 0.472	140°/180°	TiAIN + TiN	IT8

Wstęp

Wiercenie

Rozwiercanie

Wyłaczanie

Załącznik

Oznaczenie	Numer produktu	DC	LU	OAL	LFS	LS	LCF	DMM	Kąt wierzchołkowy	Pokrycie	Tolerancja otworu
		mm Cal.	mm Cal.	mm Cal.	mm Cal.	mm Cal.	mm Cal.	mm Cal.			
SD245A-12.0-56-12R1	02691705	12,0 0.472	56,0 2.205	118,0 4.646	73,0 2.874	45,0 1.772	71,0 2.795	12,0 0.472	140°/180°	TiAIN + TiN	IT8
SD245A-12.5-56-14R1	02691706	12,5 0.492	56,0 2.205	124,0 4.882	79,0 3.110	45,0 1.772	77,0 3.031	14,0 0.551	140°/180°	TiAIN + TiN	IT8
SD245A-0500-221-0551R1	02691707	12,7 0.500	56,0 2.205	124,0 4.882	79,0 3.110	45,0 1.772	77,0 3.031	14,0 0.551	140°/180°	TiAIN + TiN	IT8
SD245A-13.0-56-14R1	02691708	13,0 0.512	56,0 2.205	124,0 4.882	79,0 3.110	45,0 1.772	77,0 3.031	14,0 0.551	140°/180°	TiAIN + TiN	IT8
SD245A-05312-232-0551R1	02691709	13,494 0.5312	59,0 2.323	124,0 4.882	79,0 3.110	45,0 1.772	77,0 3.031	14,0 0.551	140°/180°	TiAIN + TiN	IT8
SD245A-13.5-59-14R1	02691710	13,5 0.5312	59,0 2.323	124,0 4.882	79,0 3.110	45,0 1.772	77,0 3.031	14,0 0.551	140°/180°	TiAIN + TiN	IT8
SD245A-14.0-59-14R1	02691711	14,0 0.551	59,0 2.323	124,0 4.882	79,0 3.110	45,0 1.772	77,0 3.031	14,0 0.551	140°/180°	TiAIN + TiN	IT8



Feedmax™ SD265A

Wiertła o dużej dokładności Seco Feedmax SD265A IT 7 charakteryzują się niezrównaną precyzją. Ponadto jedno wiertło SD265A może zastąpić wiele narzędzi i uprościć zadania wiercenia. Następujące cechy pozwalają wywiercić otwór w jednym przejściu:

- Zoptymalizowana geometria wiertła i punkt samocentrowania
- Łącznie 6 łysinek
- Wąskie tolerancje produkcyjne ($\pm 3\mu$)
- Powłoka TiAlN zapewniająca niskie tarcie i wysoką odporność na ścieranie

SD265A

Głębokość wiercenia ~ 5 x D – Metryczne/Calowe

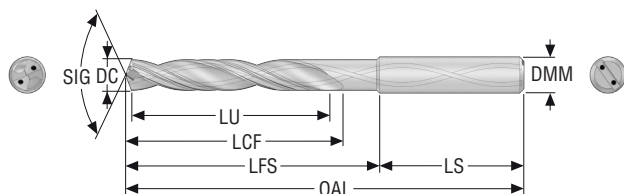

- Chwyt cylindryczny DIN 6537A
- Chłodzenie wewnętrzne
- Parametry skrawania, patrz strona (strony) 154
- Średnice pośrednie patrz aplikacja MyDesign.

Oznaczenie	Numer produktu	DC	LU	OAL	LFS	LS	LCF	DMM	Kąt wierzchołkowy	Pokrycie	Tolerancja otworu
		mm Cal.	mm Cal.	mm Cal.	mm Cal.	mm Cal.	mm Cal.	mm Cal.			
SD265A-6.006-32-6R1	02691714	6,006 0.236	32,0 1.260	82,0 3.228	46,0 1.811	36,0 1.417	44,0 1.732	6,0 0.236	140°	TiAIN + TiN	IT7
SD265A-02497-138-0315R1	02722876	6,35 0.250	35,0 1.378	91,0 3.583	55,0 2.165	36,0 1.417	53,0 2.087	8,0 0.315	140°	TiAIN + TiN	IT7
SD265A-03122-165-0315R1	02722877	7,938 0.313	42,0 1.654	91,0 3.583	55,0 2.165	36,0 1.417	53,0 2.087	8,0 0.315	140°	TiAIN + TiN	IT7
SD265A-8.008-42-8R1	02691715	8,008 0.315	42,0 1.654	91,0 3.583	55,0 2.165	36,0 1.417	53,0 2.087	8,0 0.315	140°	TiAIN + TiN	IT7
SD265A-03747-189-0394R1	02722878	9,525 0.375	48,0 1.890	103,0 4.055	63,0 2.480	40,0 1.575	61,0 2.402	10,0 0.394	140°	TiAIN + TiN	IT7
SD265A-10.008-48-10R1	02691716	10,008 0.394	48,0 1.890	103,0 4.055	63,0 2.480	40,0 1.575	61,0 2.402	10,0 0.394	140°	TiAIN + TiN	IT7
SD265A-12.009-56-12R1	02691717	12,009 0.473	56,0 2.205	118,0 4.646	73,0 2.874	45,0 1.772	71,0 2.795	12,0 0.472	140°	TiAIN + TiN	IT7
SD265A-04997-221-0551R1	02722879	12,7 0.500	56,0 2.205	124,0 4.882	79,0 3.110	45,0 1.772	77,0 3.031	14,0 0.551	140°	TiAIN + TiN	IT7
SD265A-14.009-59-14R1	02691718	14,009 0.552	59,0 2.323	124,0 4.882	79,0 3.110	45,0 1.772	77,0 3.031	14,0 0.551	140°	TiAIN + TiN	IT7
SD265A-16.009-62-16R1	02691719	16,009 0.630	62,0 2.441	133,0 5.236	85,0 3.346	48,0 1.890	83,0 3.268	16,0 0.630	140°	TiAIN + TiN	IT7



Feedmax™ — Wiertła fazujące

Wiertła Seco Feedmax™ fazujące pozwalają połączyć wiercenie i fazowanie w jeden proces celem zmaksymalizowania wydajności. Standardowy asortyment dostępnych w magazynie produktów obejmuje zastosowania do wiercenia dla standardowych gwintów metrycznych od M4 do M16.

- Specjalna konstrukcja zmniejsza koszty w przeliczeniu na otwór i zwiększa wydajność
- Specjalna powłoka o niskim tarciu zapewnia wysoką twardość na gorąco i doskonałe usuwanie wiórów
- Geometria samocentrująca zapewnia wysoką jakość otworów przy użyciu fazy 45 stopni (90 stopni pod kątem)

Wiertła z fazą – gwint M4 - M16

Metryczne/Calowe

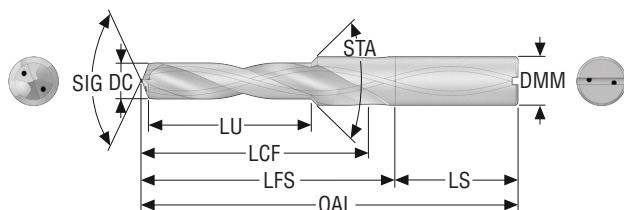

- Chwyt cylindryczny DIN 6537A
- Chłodzenie wewnętrzne
- Pokrycie: TiAlN + TiN
- Tolerancja otworu: IT8-9
- Uwzględniony kąt fazy = 90°
- Parametry skrawania, patrz strona (strony) 144, 145

Oznaczenie	Numer produktu	Typ skoku gwintu	Wielkość skoku gwintu	DC	LU	OAL	LFS	LS	LCF	DMM
				mm Cal.	mm Cal.	mm Cal.	mm Cal.	mm Cal.	mm Cal.	mm Cal.
SD203A-C45-3.3-11.4-6R1	02500320	Skok normalny Gwint metryczny	M4	3,3 0.130	11,4 0.449	66,0 2.598	26,0 1.024	36,0 1.417	20,0 0.787	6,0 0.236
SD203A-C45-3.4-11.4-6R1	02500323	Skok normalny Gwint metryczny	M4	3,4 0.134	11,4 0.449	66,0 2.598	26,0 1.024	36,0 1.417	20,0 0.787	6,0 0.236
SD203A-C45-4.2-13.6-6R1	02500324	Skok normalny Gwint metryczny	M5	4,2 0.165	13,6 0.535	66,0 2.598	30,0 1.181	36,0 1.417	24,0 0.945	6,0 0.236
SD203A-C45-4.3-13.6-6R1	02500325	Skok normalny Gwint metryczny	M5	4,3 0.169	13,6 0.535	66,0 2.598	30,0 1.181	36,0 1.417	24,0 0.945	6,0 0.236
SD203A-C45-5.0-16.5-8R1	02500326	Skok normalny Gwint metryczny	M6	5,0 0.197	16,5 0.650	79,0 3.110	43,0 1.693	36,0 1.417	28,0 1.102	8,0 0.315
SD203A-C45-5.1-16.5-8R1	02500327	Skok normalny Gwint metryczny	M6	5,1 0.201	16,5 0.650	79,0 3.110	43,0 1.693	36,0 1.417	28,0 1.102	8,0 0.315
SD203A-C45-6.8-21-10R1	02500328	Skok normalny Gwint metryczny	M8	6,8 0.268	21,0 0.827	89,0 3.504	49,0 1.929	40,0 1.575	34,0 1.339	10,0 0.394
SD203A-C45-6.9-21-10R1	02500330	Skok normalny Gwint metryczny	M8	6,9 0.272	21,0 0.827	89,0 3.504	49,0 1.929	40,0 1.575	34,0 1.339	10,0 0.394
SD203A-C45-7.0-21-10R1	02500331	Gwint metryczny drobnozwojny	M8x1.0	7,0 0.276	21,0 0.827	89,0 3.504	49,0 1.929	40,0 1.575	34,0 1.339	10,0 0.394
SD203A-C45-8.5-25.5-12R1	02500333	Skok normalny Gwint metryczny	M10	8,5 0.335	25,5 1.004	102,0 4.016	57,0 2.244	45,0 1.772	47,0 1.850	12,0 0.472
SD203A-C45-8.7-25.5-12R1	02500334	Skok normalny Gwint metryczny	M10	8,7 0.343	25,5 1.004	102,0 4.016	57,0 2.244	45,0 1.772	47,0 1.850	12,0 0.472
SD203A-C45-9.0-25.5-12R1	02500340	Gwint metryczny drobnozwojny	M10x1.0	9,0 0.354	25,5 1.004	102,0 4.016	57,0 2.244	45,0 1.772	47,0 1.850	12,0 0.472
SD203A-C45-10.2-30.0-14R1	02500342	Skok normalny Gwint metryczny	M12	10,2 0.402	30,0 1.181	107,0 4.213	62,0 2.441	45,0 1.772	55,0 2.165	14,0 0.551
SD203A-C45-10.4-30.0-14R1	02500343	Skok normalny Gwint metryczny	M12	10,4 0.409	30,0 1.181	107,0 4.213	62,0 2.441	45,0 1.772	55,0 2.165	14,0 0.551
SD203A-C45-10.5-30.0-14R1	02500344	Gwint metryczny drobnozwojny	M12x1.5	10,5 0.413	34,5 1.358	107,0 4.213	62,0 2.441	45,0 1.772	55,0 2.165	14,0 0.551
SD203A-C45-12.0-34.5-16R1	02500346	Skok normalny Gwint metryczny	M14	12,0 0.472	34,5 1.358	115,0 4.528	70,0 2.756	45,0 1.772	60,0 2.362	16,0 0.630
SD203A-C45-12.25-34.5-16R1	02500348	Skok normalny Gwint metryczny	M14	12,25 0.482	34,5 1.358	115,0 4.528	70,0 2.756	45,0 1.772	60,0 2.362	16,0 0.630
SD203A-C45-12.5-34.5-16R1	02500349	Gwint metryczny drobnozwojny	M14x1.5	12,5 0.492	34,5 1.358	115,0 4.528	70,0 2.756	45,0 1.772	60,0 2.362	16,0 0.630
SD203A-C45-14.0-38.5-18R1	02500350	Skok normalny Gwint metryczny	M16	14,0 0.551	38,5 1.516	123,0 4.843	75,0 2.953	48,0 1.890	65,0 2.559	18,0 0.709
SD203A-C45-14.25-38.5-18R1	02500354	Skok normalny Gwint metryczny	M16	14,25 0.561	38,5 1.516	123,0 4.843	75,0 2.953	48,0 1.890	65,0 2.559	18,0 0.709
SD203A-C45-14.5-38.5-18R1	02500356	Gwint metryczny drobnozwojny	M16x1.5	14,5 0.571	38,5 1.516	123,0 4.843	75,0 2.953	48,0 1.890	65,0 2.559	18,0 0.709

Wiertła z fazą – gwint M4 - M16

Metryczne/Calowe

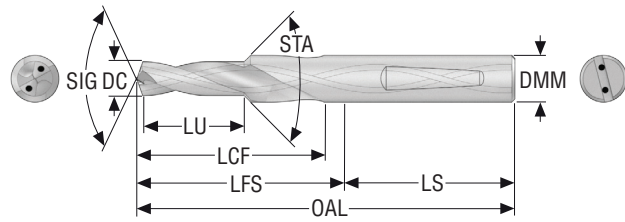

- Chwył Whistle Notch DIN6537B
- Chłodzenie wewnętrzne
- Pokrycie: TiAlN + TiN
- Tolerancja otworu: IT8-9
- Uwzględniony kąt fazy = 90°
- Parametry skrawania, patrz strona (strony) 144, 145

Oznaczenie	Numer produktu	Typ skoku gwintu	Wielkość skoku gwintu	DC	LU	OAL	LFS	LS	LCF	DMM
				mm Cal.	mm Cal.	mm Cal.	mm Cal.	mm Cal.	mm Cal.	mm Cal.
SD203A-C45-3.3-11.4-6R5	02500382	Skok normalny Gwint metryczny	M4	3,3 0.130	11,4 0.449	66,0 2.598	26,0 1.024	36,0 1.417	20,0 0.787	6,0 0.236
SD203A-C45-3.4-11.4-6R5	02500383	Skok normalny Gwint metryczny	M4	3,4 0.134	11,4 0.449	66,0 2.598	26,0 1.024	36,0 1.417	20,0 0.787	6,0 0.236
SD203A-C45-4.2-13.6-6R5	02500391	Skok normalny Gwint metryczny	M5	4,2 0.165	13,6 0.535	66,0 2.598	30,0 1.181	36,0 1.417	24,0 0.945	6,0 0.236
SD203A-C45-4.3-13.6-6R5	02500392	Skok normalny Gwint metryczny	M5	4,3 0.169	13,6 0.535	66,0 2.598	30,0 1.181	36,0 1.417	24,0 0.945	6,0 0.236
SD203A-C45-5.0-16.5-8R5	02500393	Skok normalny Gwint metryczny	M6	5,0 0.197	16,5 0.650	79,0 3.110	43,0 1.693	36,0 1.417	28,0 1.102	8,0 0.315
SD203A-C45-5.1-16.5-8R5	02500394	Skok normalny Gwint metryczny	M6	5,1 0.201	16,5 0.650	79,0 3.110	43,0 1.693	36,0 1.417	28,0 1.102	8,0 0.315
SD203A-C45-6.8-21.0-10R5	02500395	Skok normalny Gwint metryczny	M8	6,8 0.268	21,0 0.827	89,0 3.504	49,0 1.929	40,0 1.575	34,0 1.339	10,0 0.394
SD203A-C45-6.9-21.0-10R5	02500396	Skok normalny Gwint metryczny	M8	6,9 0.272	21,0 0.827	89,0 3.504	49,0 1.929	40,0 1.575	34,0 1.339	10,0 0.394
SD203A-C45-7.0-21.0-10R5	02500398	Gwint metryczny drobnozwojny	M8x1.0	7,0 0.276	21,0 0.827	89,0 3.504	49,0 1.929	40,0 1.575	34,0 1.339	10,0 0.394
SD203A-C45-8.5-25.5-12R5	02500401	Skok normalny Gwint metryczny	M10	8,5 0.335	25,5 1.004	102,0 4.016	57,0 2.244	45,0 1.772	47,0 1.850	12,0 0.472
SD203A-C45-8.7-25.5-12R5	02500403	Skok normalny Gwint metryczny	M10	8,7 0.343	25,5 1.004	102,0 4.016	57,0 2.244	45,0 1.772	47,0 1.850	12,0 0.472
SD203A-C45-9.0-25.5-12R5	02500410	Gwint metryczny drobnozwojny	M10x1.0	9,0 0.354	25,5 1.004	102,0 4.016	57,0 2.244	45,0 1.772	47,0 1.850	12,0 0.472
SD203A-C45-10.2-30.0-14R5	02500412	Skok normalny Gwint metryczny	M12	10,2 0.402	30,0 1.181	107,0 4.213	62,0 2.441	45,0 1.772	55,0 2.165	14,0 0.551
SD203A-C45-10.4-30.0-14R5	02500414	Skok normalny Gwint metryczny	M12	10,4 0.409	30,0 1.181	107,0 4.213	62,0 2.441	45,0 1.772	55,0 2.165	14,0 0.551
SD203A-C45-10.5-30.0-14R5	02500416	Gwint metryczny drobnozwojny	M12x1.5	10,5 0.413	34,5 1.358	107,0 4.213	62,0 2.441	45,0 1.772	55,0 2.165	14,0 0.551
SD203A-C45-12.0-34.5-16R5	02500417	Skok normalny Gwint metryczny	M14	12,0 0.472	34,5 1.358	115,0 4.528	70,0 2.756	45,0 1.772	60,0 2.362	16,0 0.630
SD203A-C45-12.25-34.5-16R5	02500418	Skok normalny Gwint metryczny	M14	12,25 0.482	34,5 1.358	115,0 4.528	70,0 2.756	45,0 1.772	60,0 2.362	16,0 0.630
SD203A-C45-12.5-34.5-16R5	02500420	Gwint metryczny drobnozwojny	M14x1.5	12,5 0.492	34,5 1.358	115,0 4.528	70,0 2.756	45,0 1.772	60,0 2.362	16,0 0.630
SD203A-C45-14.0-38.5-18R5	02500423	Skok normalny Gwint metryczny	M16	14,0 0.551	38,5 1.516	123,0 4.843	75,0 2.953	48,0 1.890	65,0 2.559	18,0 0.709
SD203A-C45-14.25-38.5-18R5	02500424	Skok normalny Gwint metryczny	M16	14,25 0.561	38,5 1.516	123,0 4.843	75,0 2.953	48,0 1.890	65,0 2.559	18,0 0.709
SD203A-C45-14.5-38.5-18R5	02500425	Gwint metryczny drobnozwojny	M16x1.5	14,5 0.571	38,5 1.516	123,0 4.843	75,0 2.953	48,0 1.890	65,0 2.559	18,0 0.709

Wstęp

Wiercenie

Rozwiercanie

Wyłaczanie

Załącznik

Moduł fazujący do wiertel Universal i Feedmax

Metryczne

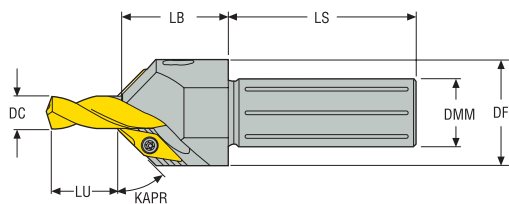

Oznaczenie	Numer produktu	Głębokość wiercenia LU				Maks. głębokość fazy (mm)	LB	DF	LS	DMM	KAPR°
		DC	3 x D LU (min-max)	5 x D LU (min-max)	7 x D LU (min-max)						
		mm	mm	mm	mm	mm	mm	mm	mm	mm	
SD200-C45-6R1	02510275	4,01-6,1	4,0-17,0	10,0-27,0	30,0-45,0	2,8	25,0	21,0	41,0	12,0	45,0
SD200-C45-8R1	02510278	6,01-8,0	15,0-27,0	24,0-35,0	42,0-57,0	2,8	25,0	25,0	44,5	16,0	45,0
SD200-C45-10R1	02510280	8,01-10,0	17,0-31,0	34,0-48,0	47,0-62,0	2,8	25,0	25,0	44,5	16,0	45,0
SD200-C45-12R1	02510281	10,01-12,0	21,0-36,0	40,0-56,0	57,0-72,0	2,8	25,0	28,0	46,5	20,0	45,0
SD200-C45-14R1	02510283	12,01-14,0	22,0-37,0	43,0-59,0	68,0-83,0	2,8	25,0	30,0	46,5	20,0	45,0
SD200-C45-16R1	02510285	14,01-16,0	23,0-39,0	44,0-60,0	76,0-92,0	2,8	34,0	32,0	53,0	25,0	45,0

Części zamienne, zawarte w dostawie

Dla śred. wiertła (mm)	Klucz do płytek	Śruba mocująca płytkę	Klucz mocujący	Śruba mocująca	Kaseta
	Płytki	Płytki	Moduł	Moduł	Moduł
4,00 - 16,00	T07P-2	C02205-T07P	H1.5-2D	SH3040	SD200-3x7.3

Płytki

Tolerancje: mm	Wielkość	L	EPSR	RE	IC	D1	AN	S
		mm		mm	mm	mm		mm
<p>IC = ±0,025 S = ±0,07 RE = ±0,10</p>	C45	9,000	45°	0,200	5,556	2,900	7°	2,500
	Gatunek: T400D							
	Oznaczenie: SD200-C45							
Numer produktu: 02510325								

Moduł fazujący do wiertel Universal i Feedmax

Całowe

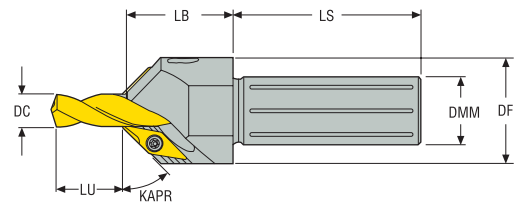

Oznaczenie	Numer produktu	DC	Głębokość wiercenia LU				Maks. głębokość fazy (mm)	DF	LB	LS	DMM	KAPR°
			3 x D LU (min-max)	5 x D LU (min-max)	7 x D LU (min-max)							
			Cal.	Cal.	Cal.	Cal.						
SD200-C45-6-500R1	02510287	0.158-0.240	0.157-0.669	0.394-1.063	1.181-1.772	0.110	0.827	0.984	1.614	0.500	45	
SD200-C45-8-625R1	02510289	0.237-0.315	0.591-1.063	0.945-1.378	1.654-2.244	0.110	0.984	0.984	1.752	0.625	45	
SD200-C45-10-625R1	02510291	0.315-0.394	0.669-1.220	1.339-1.890	1.850-2.441	0.110	0.984	0.984	1.752	0.625	45	
SD200-C45-12-750R1	02510292	0.394-0.472	0.827-1.417	1.575-2.205	2.244-2.835	0.110	1.102	0.984	1.831	0.750	45	
SD200-C45-14-750R1	02510293	0.473-0.551	0.866-1.457	1.693-2.323	2.677-3.268	0.110	1.181	0.984	1.831	0.750	45	
SD200-C45-16-1000R1	02510295	0.552-0.630	0.906-1.535	1.732-2.362	2.992-3.622	0.110	1.260	1.339	2.087	1.000	45	

Części zamienne, zawarte w dostawie

Dł. śred. wiertła (cale)	Klucz do płytek	Śruba mocująca płytkę	Klucz mocujący	Kaseta
	Płytki	Płytki	Moduł	Moduł
0.1574 - 0.6299	T07P-2	C02205-T07P	H1.5-2D	SD200-3x7.3

Płytki

Tolerancje: cal.	Wielkość	L cal.	EPSR	RE cal.	IC cal.	D1 cal.	AN	S cal.
	C45	0.3543	45°	0.0078	0.2187	0.1141	7°	0.0984
	Gatunek: T400D							
	Oznaczenie: SD200-C45							
	Numer produktu: 02510325							

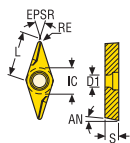

IC = ±0.001
S = ±0.0027
RE = ±0.004

Instrukcja montażu modułu fazującego

1.

2.

3.

4.

Maksymalna głębokość fazy

maks.
2.8 mm
(0.110")

Średnica wiertła DC		LU głębokość wiercenia (min-maks)					
		SD1103 / SD203A		SD1105 / SD205A		SD207A	
mm	cal.	mm	cal.	mm	cal.	mm	cal.
4,00-4,75	.157-.187	4-17	.157-.669	10-27	.394-1.063	30-45	1.181-1.772
4,76-6,00	.187-.236	6-20	.236-.787	18-32	.709-1.260	30-45	1.181-1.772
6,01-8,00	.241-.315	15-27	.590-1.063	28-42	1.102-1.653	42-57	1.653-2.244
8,01-10,00	.315-.394	17-31	.669-1.220	34-48	1.338-1.890	47-62	1.850-2.441
10,01-12,00	.394-.472	21-36	.826-1.417	40-56	1.575-2.205	57-72	2.244-2.835
12,01-14,00	.473-.551	22-37	.866-1.457	43-59	1.693-2.323	68-83	2.677-3.268
14,01-16,00	.552-.630	23-39	.906-1.535	44-60	1.732-2.362	76-92	2.992-3.622

Stosować tylko z chwytym cylindrycznym (R1).

SD203A, -MS

Głębokość wiercenia ~ 3 x D – Metryczne/Calowe

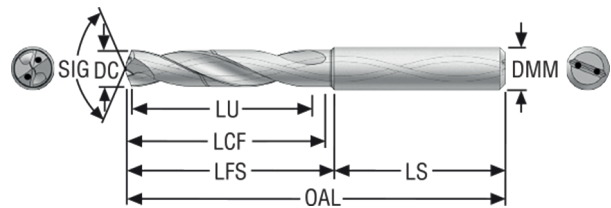

- Chwył cylindryczny DIN 6537A
- Tolerancja DC m7
- Chłodzenie wewnętrzne
- Parametry skrawania, patrz strona (strony) 155-156
- Średnice pośrednie patrz aplikacja MyDesign.

Oznaczenie	Numer produktu	DC	LU	OAL	LFS	LS	LCF	DMM	Kąt wierzchołkowy	Pokrycie	Tolerancja otworu
		mm Cal.	mm Cal.	mm Cal.	mm Cal.	mm Cal.	mm Cal.	mm Cal.			
SD203A-0200-007-04R1-MS	10004064	2,0 0.079	7,0 0.276	41,0 1.614	14,0 0.551	27,0 1.063	11,0 0.433	4,0 0.157	140°	TiAIN + NbN	IT8-9
SD203A-0210-007-04R1-MS	10004065	2,1 0.083	7,0 0.276	41,0 1.614	14,0 0.551	27,0 1.063	11,0 0.433	4,0 0.157	140°	TiAIN + NbN	IT8-9
SD203A-0220-007-04R1-MS	10004066	2,2 0.087	7,0 0.276	41,0 1.614	14,0 0.551	27,0 1.063	11,0 0.433	4,0 0.157	140°	TiAIN + NbN	IT8-9
SD203A-0230-008-04R1-MS	10004067	2,3 0.091	8,0 0.315	44,0 1.732	17,0 0.669	27,0 1.063	12,5 0.492	4,0 0.157	140°	TiAIN + NbN	IT8-9
SD203A-0240-008-04R1-MS	10004068	2,4 0.094	8,0 0.315	44,0 1.732	17,0 0.669	27,0 1.063	12,5 0.492	4,0 0.157	140°	TiAIN + NbN	IT8-9
SD203A-0250-008-04R1-MS	10004072	2,5 0.098	8,0 0.315	44,0 1.732	17,0 0.669	27,0 1.063	12,5 0.492	4,0 0.157	140°	TiAIN + NbN	IT8-9
SD203A-0260-008-04R1-MS	10004073	2,6 0.102	8,0 0.315	44,0 1.732	17,0 0.669	27,0 1.063	12,5 0.492	4,0 0.157	140°	TiAIN + NbN	IT8-9
SD203A-0270-009-04R1-MS	10004074	2,7 0.106	9,0 0.354	44,0 1.732	17,0 0.669	27,0 1.063	14,5 0.571	4,0 0.157	140°	TiAIN + NbN	IT8-9
SD203A-0278-009-04R1-MS	10004075	2,78 0.109	9,0 0.354	44,0 1.732	17,0 0.669	27,0 1.063	14,5 0.571	4,0 0.157	140°	TiAIN + NbN	IT8-9
SD203A-0290-009-04R1-MS	10004076	2,9 0.114	9,0 0.354	44,0 1.732	17,0 0.669	27,0 1.063	14,5 0.571	4,0 0.157	140°	TiAIN + NbN	IT8-9
SD203A-0300-014-06R1-MS	10004077	3,0 0.118	14,0 0.551	62,0 2.441	26,0 1.024	36,0 1.417	20,0 0.787	6,0 0.236	140°	TiAIN + NbN	IT8-9
SD203A-0310-014-06R1-MS	10004078	3,1 0.122	14,0 0.551	62,0 2.441	26,0 1.024	36,0 1.417	20,0 0.787	6,0 0.236	140°	TiAIN + NbN	IT8-9
SD203A-0320-014-06R1-MS	10004079	3,2 0.126	14,0 0.551	62,0 2.441	26,0 1.024	36,0 1.417	20,0 0.787	6,0 0.236	140°	TiAIN + NbN	IT8-9
SD203A-0330-014-06R1-MS	10004080	3,3 0.130	14,0 0.551	62,0 2.441	26,0 1.024	36,0 1.417	20,0 0.787	6,0 0.236	140°	TiAIN + NbN	IT8-9
SD203A-0340-014-06R1-MS	10004081	3,4 0.134	14,0 0.551	62,0 2.441	26,0 1.024	36,0 1.417	20,0 0.787	6,0 0.236	140°	TiAIN + NbN	IT8-9
SD203A-0350-015-06R1-MS	10004083	3,5 0.138	15,0 0.591	62,0 2.441	26,0 1.024	36,0 1.417	20,0 0.787	6,0 0.236	140°	TiAIN + NbN	IT8-9
SD203A-0357-015-06R1-MS	10004084	3,57 0.141	15,0 0.591	62,0 2.441	26,0 1.024	36,0 1.417	20,0 0.787	6,0 0.236	140°	TiAIN + NbN	IT8-9
SD203A-0370-015-06R1-MS	10004085	3,7 0.146	15,0 0.591	62,0 2.441	26,0 1.024	36,0 1.417	20,0 0.787	6,0 0.236	140°	TiAIN + NbN	IT8-9
SD203A-0380-017-06R1-MS	10004086	3,8 0.150	17,0 0.669	66,0 2.598	30,0 1.181	36,0 1.417	24,0 0.945	6,0 0.236	140°	TiAIN + NbN	IT8-9
SD203A-0390-017-06R1-MS	10004087	3,9 0.154	17,0 0.669	66,0 2.598	30,0 1.181	36,0 1.417	24,0 0.945	6,0 0.236	140°	TiAIN + NbN	IT8-9
SD203A-0397-017-06R1-MS	10004088	3,97 0.156	17,0 0.669	66,0 2.598	30,0 1.181	36,0 1.417	24,0 0.945	6,0 0.236	140°	TiAIN + NbN	IT8-9
SD203A-0400-017-06R1-MS	10004089	4,0 0.157	17,0 0.669	66,0 2.598	30,0 1.181	36,0 1.417	24,0 0.945	6,0 0.236	140°	TiAIN + NbN	IT8-9

Oznaczenie	Numer produktu	DC	LU	OAL	LFS	LS	LCF	DMM	Kąt wierzchołkowy	Pokrycie	Tolerancja otworu
		mm Cal.	mm Cal.	mm Cal.	mm Cal.	mm Cal.	mm Cal.	mm Cal.			
SD203A-0410-017-06R1-MS	10004090	4,1 0.161	17,0 0.669	66,0 2.598	30,0 1.181	36,0 1.417	24,0 0.945	6,0 0.236	140°	TiAIN + NbN	IT8-9
SD203A-0420-017-06R1-MS	10004091	4,2 0.165	17,0 0.669	66,0 2.598	30,0 1.181	36,0 1.417	24,0 0.945	6,0 0.236	140°	TiAIN + NbN	IT8-9
SD203A-0430-018-06R1-MS	10004092	4,3 0.169	18,0 0.709	66,0 2.598	30,0 1.181	36,0 1.417	24,0 0.945	6,0 0.236	140°	TiAIN + NbN	IT8-9
SD203A-0450-018-06R1-MS	10004093	4,5 0.177	18,0 0.709	66,0 2.598	30,0 1.181	36,0 1.417	24,0 0.945	6,0 0.236	140°	TiAIN + NbN	IT8-9
SD203A-0460-018-06R1-MS	10004094	4,6 0.181	18,0 0.709	66,0 2.598	30,0 1.181	36,0 1.417	26,0 1.024	6,0 0.236	140°	TiAIN + NbN	IT8-9
SD203A-0465-018-06R1-MS	10004095	4,65 0.183	18,0 0.709	66,0 2.598	30,0 1.181	36,0 1.417	26,0 1.024	6,0 0.236	140°	TiAIN + NbN	IT8-9
SD203A-0470-018-06R1-MS	10004096	4,7 0.185	18,0 0.709	66,0 2.598	30,0 1.181	36,0 1.417	26,0 1.024	6,0 0.236	140°	TiAIN + NbN	IT8-9
SD203A-0476-020-06R1-MS	10004097	4,76 0.187	20,0 0.787	66,0 2.598	30,0 1.181	36,0 1.417	28,0 1.102	6,0 0.236	140°	TiAIN + NbN	IT8-9
SD203A-0480-020-06R1-MS	10004098	4,8 0.189	20,0 0.787	66,0 2.598	30,0 1.181	36,0 1.417	28,0 1.102	6,0 0.236	140°	TiAIN + NbN	IT8-9
SD203A-0490-020-06R1-MS	10004099	4,9 0.193	20,0 0.787	66,0 2.598	30,0 1.181	36,0 1.417	28,0 1.102	6,0 0.236	140°	TiAIN + NbN	IT8-9
SD203A-0500-020-06R1-MS	10004101	5,0 0.197	20,0 0.787	66,0 2.598	30,0 1.181	36,0 1.417	28,0 1.102	6,0 0.236	140°	TiAIN + NbN	IT8-9
SD203A-0510-020-06R1-MS	10004102	5,1 0.201	20,0 0.787	66,0 2.598	30,0 1.181	36,0 1.417	28,0 1.102	6,0 0.236	140°	TiAIN + NbN	IT8-9
SD203A-0516-020-06R1-MS	10004103	5,16 0.203	20,0 0.787	66,0 2.598	30,0 1.181	36,0 1.417	28,0 1.102	6,0 0.236	140°	TiAIN + NbN	IT8-9
SD203A-0520-020-06R1-MS	10004104	5,2 0.205	20,0 0.787	66,0 2.598	30,0 1.181	36,0 1.417	28,0 1.102	6,0 0.236	140°	TiAIN + NbN	IT8-9
SD203A-0530-020-06R1-MS	10004105	5,3 0.209	20,0 0.787	66,0 2.598	30,0 1.181	36,0 1.417	28,0 1.102	6,0 0.236	140°	TiAIN + NbN	IT8-9
SD203A-0540-020-06R1-MS	10004106	5,4 0.213	20,0 0.787	66,0 2.598	30,0 1.181	36,0 1.417	28,0 1.102	6,0 0.236	140°	TiAIN + NbN	IT8-9
SD203A-0550-020-06R1-MS	10004107	5,5 0.217	20,0 0.787	66,0 2.598	30,0 1.181	36,0 1.417	28,0 1.102	6,0 0.236	140°	TiAIN + NbN	IT8-9
SD203A-0556-020-06R1-MS	10004108	5,56 0.219	20,0 0.787	66,0 2.598	30,0 1.181	36,0 1.417	28,0 1.102	6,0 0.236	140°	TiAIN + NbN	IT8-9
SD203A-0560-021-06R1-MS	10004109	5,6 0.220	21,0 0.827	66,0 2.598	30,0 1.181	36,0 1.417	28,0 1.102	6,0 0.236	140°	TiAIN + NbN	IT8-9
SD203A-0570-021-06R1-MS	10004110	5,7 0.224	21,0 0.827	66,0 2.598	30,0 1.181	36,0 1.417	28,0 1.102	6,0 0.236	140°	TiAIN + NbN	IT8-9
SD203A-0580-021-06R1-MS	10004111	5,8 0.228	21,0 0.827	66,0 2.598	30,0 1.181	36,0 1.417	28,0 1.102	6,0 0.236	140°	TiAIN + NbN	IT8-9
SD203A-0590-021-06R1-MS	10004112	5,9 0.232	21,0 0.827	66,0 2.598	30,0 1.181	36,0 1.417	28,0 1.102	6,0 0.236	140°	TiAIN + NbN	IT8-9
SD203A-0595-021-06R1-MS	10004113	5,95 0.234	21,0 0.827	66,0 2.598	30,0 1.181	36,0 1.417	28,0 1.102	6,0 0.236	140°	TiAIN + NbN	IT8-9
SD203A-0600-021-06R1-MS	10004114	6,0 0.236	21,0 0.827	66,0 2.598	30,0 1.181	36,0 1.417	28,0 1.102	6,0 0.236	140°	TiAIN + NbN	IT8-9
SD203A-0610-021-08R1-MS	10004115	6,1 0.240	21,0 0.827	79,0 3.110	43,0 1.693	36,0 1.417	34,0 1.339	8,0 0.315	140°	TiAIN + NbN	IT8-9
SD203A-0620-021-08R1-MS	10004116	6,2 0.244	21,0 0.827	79,0 3.110	43,0 1.693	36,0 1.417	34,0 1.339	8,0 0.315	140°	TiAIN + NbN	IT8-9
SD203A-0630-021-08R1-MS	10004117	6,3 0.248	21,0 0.827	79,0 3.110	43,0 1.693	36,0 1.417	34,0 1.339	8,0 0.315	140°	TiAIN + NbN	IT8-9
SD203A-0635-023-08R1-MS	10004121	6,35 0.250	23,0 0.906	79,0 3.110	43,0 1.693	36,0 1.417	34,0 1.339	8,0 0.315	140°	TiAIN + NbN	IT8-9
SD203A-0650-023-08R1-MS	10004122	6,5 0.256	23,0 0.906	79,0 3.110	43,0 1.693	36,0 1.417	34,0 1.339	8,0 0.315	140°	TiAIN + NbN	IT8-9
SD203A-0660-023-08R1-MS	10004123	6,6 0.260	23,0 0.906	79,0 3.110	43,0 1.693	36,0 1.417	34,0 1.339	8,0 0.315	140°	TiAIN + NbN	IT8-9
SD203A-0675-025-08R1-MS	10004124	6,75 0.266	25,0 0.984	79,0 3.110	43,0 1.693	36,0 1.417	34,0 1.339	8,0 0.315	140°	TiAIN + NbN	IT8-9

Oznaczenie	Numer produktu	DC	LU	OAL	LFS	LS	LCF	DMM	Kąt wierzchołkowy	Pokrycie	Tolerancja otworu
		mm Cal.	mm Cal.	mm Cal.	mm Cal.	mm Cal.	mm Cal.	mm Cal.			
SD203A-0680-025-08R1-MS	10004125	6,8 0.268	25,0 0.984	79,0 3.110	43,0 1.693	36,0 1.417	34,0 1.339	8,0 0.315	140°	TiAIN + NbN	IT8-9
SD203A-0690-025-08R1-MS	10004127	6,9 0.272	25,0 0.984	79,0 3.110	43,0 1.693	36,0 1.417	34,0 1.339	8,0 0.315	140°	TiAIN + NbN	IT8-9
SD203A-0700-025-08R1-MS	10004128	7,0 0.276	25,0 0.984	79,0 3.110	43,0 1.693	36,0 1.417	34,0 1.339	8,0 0.315	140°	TiAIN + NbN	IT8-9
SD203A-0710-025-08R1-MS	10004129	7,1 0.280	25,0 0.984	79,0 3.110	43,0 1.693	36,0 1.417	41,0 1.614	8,0 0.315	140°	TiAIN + NbN	IT8-9
SD203A-0714-025-08R1-MS	10004130	7,14 0.281	25,0 0.984	79,0 3.110	43,0 1.693	36,0 1.417	41,0 1.614	8,0 0.315	140°	TiAIN + NbN	IT8-9
SD203A-0720-025-08R1-MS	10004132	7,2 0.283	25,0 0.984	79,0 3.110	43,0 1.693	36,0 1.417	41,0 1.614	8,0 0.315	140°	TiAIN + NbN	IT8-9
SD203A-0730-025-08R1-MS	10004133	7,3 0.287	25,0 0.984	79,0 3.110	43,0 1.693	36,0 1.417	41,0 1.614	8,0 0.315	140°	TiAIN + NbN	IT8-9
SD203A-0740-025-08R1-MS	10004134	7,4 0.291	25,0 0.984	79,0 3.110	43,0 1.693	36,0 1.417	41,0 1.614	8,0 0.315	140°	TiAIN + NbN	IT8-9
SD203A-0750-025-08R1-MS	10004135	7,5 0.295	25,0 0.984	79,0 3.110	43,0 1.693	36,0 1.417	41,0 1.614	8,0 0.315	140°	TiAIN + NbN	IT8-9
SD203A-0760-027-08R1-MS	10004136	7,6 0.299	27,0 1.063	79,0 3.110	43,0 1.693	36,0 1.417	41,0 1.614	8,0 0.315	140°	TiAIN + NbN	IT8-9
SD203A-0780-027-08R1-MS	10004137	7,8 0.307	27,0 1.063	79,0 3.110	43,0 1.693	36,0 1.417	41,0 1.614	8,0 0.315	140°	TiAIN + NbN	IT8-9
SD203A-0794-027-08R1-MS	10004138	7,94 0.313	27,0 1.063	79,0 3.110	43,0 1.693	36,0 1.417	41,0 1.614	8,0 0.315	140°	TiAIN + NbN	IT8-9
SD203A-0800-027-08R1-MS	10004139	8,0 0.315	27,0 1.063	79,0 3.110	43,0 1.693	36,0 1.417	41,0 1.614	8,0 0.315	140°	TiAIN + NbN	IT8-9
SD203A-0810-027-10R1-MS	10004140	8,1 0.319	27,0 1.063	89,0 3.504	49,0 1.929	40,0 1.575	47,0 1.850	10,0 0.394	140°	TiAIN + NbN	IT8-9
SD203A-0820-027-10R1-MS	10004141	8,2 0.323	27,0 1.063	89,0 3.504	49,0 1.929	40,0 1.575	47,0 1.850	10,0 0.394	140°	TiAIN + NbN	IT8-9
SD203A-0830-027-10R1-MS	10004143	8,3 0.327	27,0 1.063	89,0 3.504	49,0 1.929	40,0 1.575	47,0 1.850	10,0 0.394	140°	TiAIN + NbN	IT8-9
SD203A-0840-027-10R1-MS	10004144	8,4 0.331	27,0 1.063	89,0 3.504	49,0 1.929	40,0 1.575	47,0 1.850	10,0 0.394	140°	TiAIN + NbN	IT8-9
SD203A-0850-027-10R1-MS	10004146	8,5 0.335	27,0 1.063	89,0 3.504	49,0 1.929	40,0 1.575	47,0 1.850	10,0 0.394	140°	TiAIN + NbN	IT8-9
SD203A-0860-029-10R1-MS	10004147	8,6 0.339	29,0 1.142	89,0 3.504	49,0 1.929	40,0 1.575	47,0 1.850	10,0 0.394	140°	TiAIN + NbN	IT8-9
SD203A-0870-029-10R1-MS	10004148	8,7 0.343	29,0 1.142	89,0 3.504	49,0 1.929	40,0 1.575	47,0 1.850	10,0 0.394	140°	TiAIN + NbN	IT8-9
SD203A-0873-029-10R1-MS	10004149	8,73 0.344	29,0 1.142	89,0 3.504	49,0 1.929	40,0 1.575	47,0 1.850	10,0 0.394	140°	TiAIN + NbN	IT8-9
SD203A-0880-029-10R1-MS	10004150	8,8 0.346	29,0 1.142	89,0 3.504	49,0 1.929	40,0 1.575	47,0 1.850	10,0 0.394	140°	TiAIN + NbN	IT8-9
SD203A-0900-029-10R1-MS	10004151	9,0 0.354	29,0 1.142	89,0 3.504	49,0 1.929	40,0 1.575	47,0 1.850	10,0 0.394	140°	TiAIN + NbN	IT8-9
SD203A-0910-029-10R1-MS	10004153	9,1 0.358	29,0 1.142	89,0 3.504	49,0 1.929	40,0 1.575	47,0 1.850	10,0 0.394	140°	TiAIN + NbN	IT8-9
SD203A-0913-029-10R1-MS	10004154	9,13 0.359	29,0 1.142	89,0 3.504	49,0 1.929	40,0 1.575	47,0 1.850	10,0 0.394	140°	TiAIN + NbN	IT8-9
SD203A-0920-029-10R1-MS	10004156	9,2 0.362	29,0 1.142	89,0 3.504	49,0 1.929	40,0 1.575	47,0 1.850	10,0 0.394	140°	TiAIN + NbN	IT8-9
SD203A-0930-029-10R1-MS	10004157	9,3 0.366	29,0 1.142	89,0 3.504	49,0 1.929	40,0 1.575	47,0 1.850	10,0 0.394	140°	TiAIN + NbN	IT8-9
SD203A-0950-029-10R1-MS	10004158	9,5 0.374	29,0 1.142	89,0 3.504	49,0 1.929	40,0 1.575	47,0 1.850	10,0 0.394	140°	TiAIN + NbN	IT8-9
SD203A-0953-031-10R1-MS	10004160	9,53 0.375	31,0 1.220	89,0 3.504	49,0 1.929	40,0 1.575	47,0 1.850	10,0 0.394	140°	TiAIN + NbN	IT8-9
SD203A-0970-031-10R1-MS	10004161	9,7 0.382	31,0 1.220	89,0 3.504	49,0 1.929	40,0 1.575	47,0 1.850	10,0 0.394	140°	TiAIN + NbN	IT8-9
SD203A-0980-031-10R1-MS	10004162	9,8 0.386	31,0 1.220	89,0 3.504	49,0 1.929	40,0 1.575	47,0 1.850	10,0 0.394	140°	TiAIN + NbN	IT8-9

Wstęp

Wiercenie

Rozwiercanie

Wyłaczanie

Załącznik

Oznaczenie	Numer produktu	DC	LU	OAL	LFS	LS	LCF	DMM	Kąt wierzchołkowy	Pokrycie	Tolerancja otworu
		mm Cal.	mm Cal.	mm Cal.	mm Cal.	mm Cal.	mm Cal.	mm Cal.			
SD203A-0990-031-10R1-MS	10004163	9,9 0.390	31,0 1.220	89,0 3.504	49,0 1.929	40,0 1.575	47,0 1.850	10,0 0.394	140°	TiAIN + NbN	IT8-9
SD203A-0992-031-10R1-MS	10004164	9,92 0.391	31,0 1.220	89,0 3.504	49,0 1.929	40,0 1.575	47,0 1.850	10,0 0.394	140°	TiAIN + NbN	IT8-9
SD203A-1000-031-10R1-MS	10004165	10,0 0.394	31,0 1.220	89,0 3.504	49,0 1.929	40,0 1.575	47,0 1.850	10,0 0.394	140°	TiAIN + NbN	IT8-9
SD203A-1010-031-12R1-MS	10004166	10,1 0.398	31,0 1.220	102,0 4.016	57,0 2.244	45,0 1.772	55,0 2.165	12,0 0.472	140°	TiAIN + NbN	IT8-9
SD203A-1020-031-12R1-MS	10004167	10,2 0.402	31,0 1.220	102,0 4.016	57,0 2.244	45,0 1.772	55,0 2.165	12,0 0.472	140°	TiAIN + NbN	IT8-9
SD203A-1032-031-12R1-MS	10004168	10,32 0.406	31,0 1.220	102,0 4.016	57,0 2.244	45,0 1.772	55,0 2.165	12,0 0.472	140°	TiAIN + NbN	IT8-9
SD203A-1040-031-12R1-MS	10004169	10,4 0.409	31,0 1.220	102,0 4.016	57,0 2.244	45,0 1.772	55,0 2.165	12,0 0.472	140°	TiAIN + NbN	IT8-9
SD203A-1050-031-12R1-MS	10004170	10,5 0.413	31,0 1.220	102,0 4.016	57,0 2.244	45,0 1.772	55,0 2.165	12,0 0.472	140°	TiAIN + NbN	IT8-9
SD203A-1072-033-12R1-MS	10004171	10,72 0.422	33,0 1.299	102,0 4.016	57,0 2.244	45,0 1.772	55,0 2.165	12,0 0.472	140°	TiAIN + NbN	IT8-9
SD203A-1080-033-12R1-MS	10004172	10,8 0.425	33,0 1.299	102,0 4.016	57,0 2.244	45,0 1.772	55,0 2.165	12,0 0.472	140°	TiAIN + NbN	IT8-9
SD203A-1100-033-12R1-MS	10004173	11,0 0.433	33,0 1.299	102,0 4.016	57,0 2.244	45,0 1.772	55,0 2.165	12,0 0.472	140°	TiAIN + NbN	IT8-9
SD203A-1111-033-12R1-MS	10004174	11,11 0.437	33,0 1.299	102,0 4.016	57,0 2.244	45,0 1.772	55,0 2.165	12,0 0.472	140°	TiAIN + NbN	IT8-9
SD203A-1120-033-12R1-MS	10004175	11,2 0.441	33,0 1.299	102,0 4.016	57,0 2.244	45,0 1.772	55,0 2.165	12,0 0.472	140°	TiAIN + NbN	IT8-9
SD203A-1150-033-12R1-MS	10004176	11,5 0.453	33,0 1.299	102,0 4.016	57,0 2.244	45,0 1.772	55,0 2.165	12,0 0.472	140°	TiAIN + NbN	IT8-9
SD203A-1180-033-12R1-MS	10004177	11,8 0.465	33,0 1.299	102,0 4.016	57,0 2.244	45,0 1.772	55,0 2.165	12,0 0.472	140°	TiAIN + NbN	IT8-9
SD203A-1191-036-12R1-MS	10004309	11,91 0.469	36,0 1.417	102,0 4.016	57,0 2.244	45,0 1.772	55,0 2.165	12,0 0.472	140°	TiAIN + NbN	IT8-9
SD203A-1200-036-12R1-MS	10004314	12,0 0.472	36,0 1.417	102,0 4.016	57,0 2.244	45,0 1.772	55,0 2.165	12,0 0.472	140°	TiAIN + NbN	IT8-9
SD203A-1210-036-14R1-MS	10004315	12,1 0.476	36,0 1.417	107,0 4.213	62,0 2.441	45,0 1.772	60,0 2.362	14,0 0.551	140°	TiAIN + NbN	IT8-9
SD203A-1250-036-14R1-MS	10004316	12,5 0.492	36,0 1.417	107,0 4.213	62,0 2.441	45,0 1.772	60,0 2.362	14,0 0.551	140°	TiAIN + NbN	IT8-9
SD203A-1270-036-14R1-MS	10004317	12,7 0.500	36,0 1.417	107,0 4.213	62,0 2.441	45,0 1.772	60,0 2.362	14,0 0.551	140°	TiAIN + NbN	IT8-9
SD203A-1300-036-14R1-MS	10004319	13,0 0.512	36,0 1.417	107,0 4.213	62,0 2.441	45,0 1.772	60,0 2.362	14,0 0.551	140°	TiAIN + NbN	IT8-9
SD203A-1310-036-14R1-MS	10004320	13,1 0.516	36,0 1.417	107,0 4.213	62,0 2.441	45,0 1.772	60,0 2.362	14,0 0.551	140°	TiAIN + NbN	IT8-9
SD203A-1350-037-14R1-MS	10004321	13,5 0.531	37,0 1.457	107,0 4.213	62,0 2.441	45,0 1.772	60,0 2.362	14,0 0.551	140°	TiAIN + NbN	IT8-9
SD203A-1400-037-14R1-MS	10004325	14,0 0.551	37,0 1.457	107,0 4.213	62,0 2.441	45,0 1.772	60,0 2.362	14,0 0.551	140°	TiAIN + NbN	IT8-9
SD203A-1420-037-16R1-MS	10004332	14,2 0.559	37,0 1.457	115,0 4.528	67,0 2.638	48,0 1.890	65,0 2.559	16,0 0.630	140°	TiAIN + NbN	IT8-9
SD203A-1425-038-16R1-MS	10004333	14,25 0.561	38,0 1.496	115,0 4.528	67,0 2.638	48,0 1.890	65,0 2.559	16,0 0.630	140°	TiAIN + NbN	IT8-9
SD203A-1470-038-16R1-MS	10004334	14,7 0.579	38,0 1.496	115,0 4.528	67,0 2.638	48,0 1.890	65,0 2.559	16,0 0.630	140°	TiAIN + NbN	IT8-9
SD203A-1500-040-16R1-MS	10004335	15,0 0.591	40,0 1.575	115,0 4.528	67,0 2.638	48,0 1.890	65,0 2.559	16,0 0.630	140°	TiAIN + NbN	IT8-9
SD203A-1525-040-16R1-MS	10004336	15,25 0.600	40,0 1.575	115,0 4.528	67,0 2.638	48,0 1.890	65,0 2.559	16,0 0.630	140°	TiAIN + NbN	IT8-9
SD203A-1550-040-16R1-MS	10004338	15,5 0.610	40,0 1.575	115,0 4.528	67,0 2.638	48,0 1.890	65,0 2.559	16,0 0.630	140°	TiAIN + NbN	IT8-9
SD203A-1588-040-16R1-MS	10004339	15,88 0.625	40,0 1.575	115,0 4.528	67,0 2.638	48,0 1.890	65,0 2.559	16,0 0.630	140°	TiAIN + NbN	IT8-9

Oznaczenie	Numer produktu	DC	LU	OAL	LFS	LS	LCF	DMM	Kąt wierzchołkowy	Pokrycie	Tolerancja otworu
		mm Cal.	mm Cal.	mm Cal.	mm Cal.	mm Cal.	mm Cal.	mm Cal.			
SD203A-1600-040-16R1-MS	10004340	16,0 0.630	40,0 1.575	115,0 4.528	67,0 2.638	48,0 1.890	65,0 2.559	16,0 0.630	140°	TiAIN + NbN	IT8-9
SD203A-1650-045-18R1-MS	10004341	16,5 0.650	45,0 1.772	123,0 4.843	75,0 2.953	48,0 1.890	73,0 2.874	18,0 0.709	140°	TiAIN + NbN	IT8-9
SD203A-1700-045-18R1-MS	10004342	17,0 0.669	45,0 1.772	123,0 4.843	75,0 2.953	48,0 1.890	73,0 2.874	18,0 0.709	140°	TiAIN + NbN	IT8-9
SD203A-1750-045-18R1-MS	10004343	17,5 0.689	45,0 1.772	123,0 4.843	75,0 2.953	48,0 1.890	73,0 2.874	18,0 0.709	140°	TiAIN + NbN	IT8-9
SD203A-1800-045-18R1-MS	10004344	18,0 0.709	45,0 1.772	123,0 4.843	75,0 2.953	48,0 1.890	73,0 2.874	18,0 0.709	140°	TiAIN + NbN	IT8-9
SD203A-1850-050-20R1-MS	10004345	18,5 0.728	50,0 1.969	131,0 5.157	81,0 3.189	50,0 1.969	79,0 3.110	20,0 0.787	140°	TiAIN + NbN	IT8-9
SD203A-1900-050-20R1-MS	10004346	19,0 0.748	50,0 1.969	131,0 5.157	81,0 3.189	50,0 1.969	79,0 3.110	20,0 0.787	140°	TiAIN + NbN	IT8-9
SD203A-1905-050-20R1-MS	10004347	19,05 0.750	50,0 1.969	131,0 5.157	81,0 3.189	50,0 1.969	79,0 3.110	20,0 0.787	140°	TiAIN + NbN	IT8-9
SD203A-1950-050-20R1-MS	10004348	19,5 0.768	50,0 1.969	131,0 5.157	81,0 3.189	50,0 1.969	79,0 3.110	20,0 0.787	140°	TiAIN + NbN	IT8-9
SD203A-2000-050-20R1-MS	10004349	20,0 0.787	50,0 1.969	131,0 5.157	81,0 3.189	50,0 1.969	79,0 3.110	20,0 0.787	140°	TiAIN + NbN	IT8-9

SD205A, -MS

Głębokość wiercenia ~ 5 x D – Metryczne/Calowe

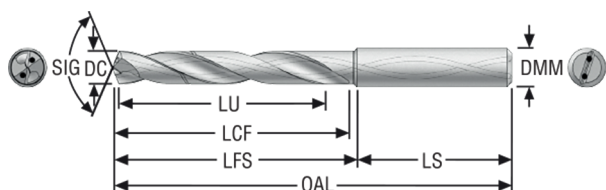

- Chwyt cylindryczny DIN 6537A
- Tolerancja DC m7
- Chłodzenie wewnętrzne
- Parametry skrawania, patrz strona (strony) 157-158
- Średnice pośrednie patrz aplikacja MyDesign.

Oznaczenie	Numer produktu	DC	LU	OAL	LFS	LS	LCF	DMM	Kąt wierzchołkowy	Pokrycie	Tolerancja otworu
		mm Cal.	mm Cal.	mm Cal.	mm Cal.	mm Cal.	mm Cal.	mm Cal.			
SD205A-0200-012-04R1-MS	10004179	2,0 0.079	12,0 0.472	46,0 1.811	19,0 0.748	27,0 1.063	15,0 0.591	4,0 0.157	140°	TiAlN + NbN	IT8-9
SD205A-0210-012-04R1-MS	10004180	2,1 0.083	12,0 0.472	46,0 1.811	19,0 0.748	27,0 1.063	15,0 0.591	4,0 0.157	140°	TiAlN + NbN	IT8-9
SD205A-0220-012-04R1-MS	10004181	2,2 0.087	12,0 0.472	46,0 1.811	19,0 0.748	27,0 1.063	15,0 0.591	4,0 0.157	140°	TiAlN + NbN	IT8-9
SD205A-0230-012-04R1-MS	10004182	2,3 0.091	12,0 0.472	46,0 1.811	19,0 0.748	27,0 1.063	15,0 0.591	4,0 0.157	140°	TiAlN + NbN	IT8-9
SD205A-0240-013-04R1-MS	10004183	2,4 0.094	13,0 0.512	50,0 1.969	23,0 0.906	27,0 1.063	17,5 0.689	4,0 0.157	140°	TiAlN + NbN	IT8-9
SD205A-0250-013-04R1-MS	10004184	2,5 0.098	13,0 0.512	50,0 1.969	23,0 0.906	27,0 1.063	17,5 0.689	4,0 0.157	140°	TiAlN + NbN	IT8-9
SD205A-0260-013-04R1-MS	10004185	2,6 0.102	13,0 0.512	50,0 1.969	23,0 0.906	27,0 1.063	17,5 0.689	4,0 0.157	140°	TiAlN + NbN	IT8-9
SD205A-0270-013-04R1-MS	10004186	2,7 0.106	15,0 0.591	50,0 1.969	23,0 0.906	27,0 1.063	20,5 0.807	4,0 0.157	140°	TiAlN + NbN	IT8-9
SD205A-0280-013-04R1-MS	10004187	2,8 0.110	15,0 0.591	50,0 1.969	23,0 0.906	27,0 1.063	20,5 0.807	4,0 0.157	140°	TiAlN + NbN	IT8-9
SD205A-0300-021-06R1-MS	10004188	3,0 0.118	21,0 0.827	66,0 2.598	30,0 1.181	36,0 1.417	26,0 1.024	6,0 0.236	140°	TiAlN + NbN	IT8-9
SD205A-0310-021-06R1-MS	10004189	3,1 0.122	21,0 0.827	66,0 2.598	30,0 1.181	36,0 1.417	26,0 1.024	6,0 0.236	140°	TiAlN + NbN	IT8-9
SD205A-0318-021-06R1-MS	10004191	3,18 0.125	21,0 0.827	66,0 2.598	30,0 1.181	36,0 1.417	26,0 1.024	6,0 0.236	140°	TiAlN + NbN	IT8-9
SD205A-0330-021-06R1-MS	10004192	3,3 0.130	21,0 0.827	66,0 2.598	30,0 1.181	36,0 1.417	26,0 1.024	6,0 0.236	140°	TiAlN + NbN	IT8-9
SD205A-0340-021-06R1-MS	10004193	3,4 0.134	21,0 0.827	66,0 2.598	30,0 1.181	36,0 1.417	26,0 1.024	6,0 0.236	140°	TiAlN + NbN	IT8-9
SD205A-0350-021-06R1-MS	10004194	3,5 0.138	21,0 0.827	66,0 2.598	30,0 1.181	36,0 1.417	26,0 1.024	6,0 0.236	140°	TiAlN + NbN	IT8-9
SD205A-0360-027-06R1-MS	10004195	3,6 0.142	21,0 0.827	66,0 2.598	30,0 1.181	36,0 1.417	26,0 1.024	6,0 0.236	140°	TiAlN + NbN	IT8-9
SD205A-0380-027-06R1-MS	10004196	3,8 0.150	27,0 1.063	74,0 2.913	38,0 1.496	36,0 1.417	34,0 1.339	6,0 0.236	140°	TiAlN + NbN	IT8-9
SD205A-0390-027-06R1-MS	10004197	3,9 0.154	27,0 1.063	74,0 2.913	38,0 1.496	36,0 1.417	34,0 1.339	6,0 0.236	140°	TiAlN + NbN	IT8-9
SD205A-0400-027-06R1-MS	10004198	4,0 0.157	27,0 1.063	74,0 2.913	38,0 1.496	36,0 1.417	34,0 1.339	6,0 0.236	140°	TiAlN + NbN	IT8-9
SD205A-0410-027-06R1-MS	10004199	4,1 0.161	27,0 1.063	74,0 2.913	38,0 1.496	36,0 1.417	34,0 1.339	6,0 0.236	140°	TiAlN + NbN	IT8-9
SD205A-0420-027-06R1-MS	10004200	4,2 0.165	27,0 1.063	74,0 2.913	38,0 1.496	36,0 1.417	34,0 1.339	6,0 0.236	140°	TiAlN + NbN	IT8-9

Oznaczenie	Numer produktu	DC	LU	OAL	LFS	LS	LCF	DMM	Kąt wierzchołkowy	Pokrycie	Tolerancja otworu
		mm Cal.	mm Cal.	mm Cal.	mm Cal.	mm Cal.	mm Cal.	mm Cal.			
SD205A-0430-027-06R1-MS	10004201	4,3 0.169	27,0 1.063	74,0 2.913	38,0 1.496	36,0 1.417	34,0 1.339	6,0 0.236	140°	TiAIN + NbN	IT8-9
SD205A-0450-027-06R1-MS	10004202	4,5 0.177	27,0 1.063	74,0 2.913	38,0 1.496	36,0 1.417	34,0 1.339	6,0 0.236	140°	TiAIN + NbN	IT8-9
SD205A-0460-027-06R1-MS	10004203	4,6 0.181	27,0 1.063	74,0 2.913	38,0 1.496	36,0 1.417	34,0 1.339	6,0 0.236	140°	TiAIN + NbN	IT8-9
SD205A-0465-027-06R1-MS	10004205	4,65 0.183	27,0 1.063	74,0 2.913	38,0 1.496	36,0 1.417	34,0 1.339	6,0 0.236	140°	TiAIN + NbN	IT8-9
SD205A-0470-027-06R1-MS	10004206	4,7 0.185	27,0 1.063	74,0 2.913	38,0 1.496	36,0 1.417	34,0 1.339	6,0 0.236	140°	TiAIN + NbN	IT8-9
SD205A-0476-027-06R1-MS	10004208	4,76 0.187	32,0 1.260	82,0 3.228	46,0 1.811	36,0 1.417	44,0 1.732	6,0 0.236	140°	TiAIN + NbN	IT8-9
SD205A-0490-032-06R1-MS	10004209	4,9 0.193	32,0 1.260	82,0 3.228	46,0 1.811	36,0 1.417	44,0 1.732	6,0 0.236	140°	TiAIN + NbN	IT8-9
SD205A-0500-032-06R1-MS	10004211	5,0 0.197	32,0 1.260	82,0 3.228	46,0 1.811	36,0 1.417	44,0 1.732	6,0 0.236	140°	TiAIN + NbN	IT8-9
SD205A-0510-032-06R1-MS	10004212	5,1 0.201	32,0 1.260	82,0 3.228	46,0 1.811	36,0 1.417	44,0 1.732	6,0 0.236	140°	TiAIN + NbN	IT8-9
SD205A-0516-032-06R1-MS	10004213	5,16 0.203	32,0 1.260	82,0 3.228	46,0 1.811	36,0 1.417	44,0 1.732	6,0 0.236	140°	TiAIN + NbN	IT8-9
SD205A-0520-032-06R1-MS	10004214	5,2 0.205	32,0 1.260	82,0 3.228	46,0 1.811	36,0 1.417	44,0 1.732	6,0 0.236	140°	TiAIN + NbN	IT8-9
SD205A-0550-032-06R1-MS	10004215	5,5 0.217	32,0 1.260	82,0 3.228	46,0 1.811	36,0 1.417	44,0 1.732	6,0 0.236	140°	TiAIN + NbN	IT8-9
SD205A-0556-032-06R1-MS	10004216	5,56 0.219	32,0 1.260	82,0 3.228	46,0 1.811	36,0 1.417	44,0 1.732	6,0 0.236	140°	TiAIN + NbN	IT8-9
SD205A-0560-032-06R1-MS	10004218	5,6 0.220	32,0 1.260	82,0 3.228	46,0 1.811	36,0 1.417	44,0 1.732	6,0 0.236	140°	TiAIN + NbN	IT8-9
SD205A-0580-032-06R1-MS	10004219	5,8 0.228	32,0 1.260	82,0 3.228	46,0 1.811	36,0 1.417	44,0 1.732	6,0 0.236	140°	TiAIN + NbN	IT8-9
SD205A-0590-032-06R1-MS	10004220	5,9 0.232	32,0 1.260	82,0 3.228	46,0 1.811	36,0 1.417	44,0 1.732	6,0 0.236	140°	TiAIN + NbN	IT8-9
SD205A-0595-032-06R1-MS	10004221	5,95 0.234	32,0 1.260	82,0 3.228	46,0 1.811	36,0 1.417	44,0 1.732	6,0 0.236	140°	TiAIN + NbN	IT8-9
SD205A-0600-032-06R1-MS	10004222	6,0 0.236	32,0 1.260	82,0 3.228	46,0 1.811	36,0 1.417	44,0 1.732	6,0 0.236	140°	TiAIN + NbN	IT8-9
SD205A-0620-035-08R1-MS	10004224	6,2 0.244	35,0 1.378	91,0 3.583	55,0 2.165	36,0 1.417	53,0 2.087	8,0 0.315	140°	TiAIN + NbN	IT8-9
SD205A-0630-035-08R1-MS	10004225	6,3 0.248	35,0 1.378	91,0 3.583	55,0 2.165	36,0 1.417	53,0 2.087	8,0 0.315	140°	TiAIN + NbN	IT8-9
SD205A-0635-035-08R1-MS	10004226	6,35 0.250	35,0 1.378	91,0 3.583	55,0 2.165	36,0 1.417	53,0 2.087	8,0 0.315	140°	TiAIN + NbN	IT8-9
SD205A-0640-035-08R1-MS	10004227	6,4 0.252	35,0 1.378	91,0 3.583	55,0 2.165	36,0 1.417	53,0 2.087	8,0 0.315	140°	TiAIN + NbN	IT8-9
SD205A-0650-035-08R1-MS	10004228	6,5 0.256	35,0 1.378	91,0 3.583	55,0 2.165	36,0 1.417	53,0 2.087	8,0 0.315	140°	TiAIN + NbN	IT8-9
SD205A-0660-035-08R1-MS	10004229	6,6 0.260	35,0 1.378	91,0 3.583	55,0 2.165	36,0 1.417	53,0 2.087	8,0 0.315	140°	TiAIN + NbN	IT8-9
SD205A-0670-035-08R1-MS	10004231	6,7 0.264	35,0 1.378	91,0 3.583	55,0 2.165	36,0 1.417	53,0 2.087	8,0 0.315	140°	TiAIN + NbN	IT8-9
SD205A-0680-040-08R1-MS	10004234	6,8 0.268	40,0 1.575	91,0 3.583	55,0 2.165	36,0 1.417	53,0 2.087	8,0 0.315	140°	TiAIN + NbN	IT8-9
SD205A-0690-040-08R1-MS	10004235	6,9 0.272	40,0 1.575	91,0 3.583	55,0 2.165	36,0 1.417	53,0 2.087	8,0 0.315	140°	TiAIN + NbN	IT8-9
SD205A-0700-040-08R1-MS	10004236	7,0 0.276	40,0 1.575	91,0 3.583	55,0 2.165	36,0 1.417	53,0 2.087	8,0 0.315	140°	TiAIN + NbN	IT8-9
SD205A-0710-040-08R1-MS	10004237	7,1 0.280	40,0 1.575	91,0 3.583	55,0 2.165	36,0 1.417	53,0 2.087	8,0 0.315	140°	TiAIN + NbN	IT8-9
SD205A-0714-040-08R1-MS	10004238	7,14 0.281	40,0 1.575	91,0 3.583	55,0 2.165	36,0 1.417	53,0 2.087	8,0 0.315	140°	TiAIN + NbN	IT8-9
SD205A-0720-040-08R1-MS	10004239	7,2 0.283	40,0 1.575	91,0 3.583	55,0 2.165	36,0 1.417	53,0 2.087	8,0 0.315	140°	TiAIN + NbN	IT8-9

Oznaczenie	Numer produktu	DC	LU	OAL	LFS	LS	LCF	DMM	Kąt wierzchołkowy	Pokrycie	Tolerancja otworu
		mm Cal.	mm Cal.	mm Cal.	mm Cal.	mm Cal.	mm Cal.	mm Cal.			
SD205A-0750-040-08R1-MS	10004240	7,5 0.295	40,0 1.575	91,0 3.583	55,0 2.165	36,0 1.417	53,0 2.087	8,0 0.315	140°	TiAIN + NbN	IT8-9
SD205A-0780-042-08R1-MS	10004241	7,8 0.307	42,0 1.654	91,0 3.583	55,0 2.165	36,0 1.417	53,0 2.087	8,0 0.315	140°	TiAIN + NbN	IT8-9
SD205A-0794-042-08R1-MS	10004243	7,94 0.313	42,0 1.654	91,0 3.583	55,0 2.165	36,0 1.417	53,0 2.087	8,0 0.315	140°	TiAIN + NbN	IT8-9
SD205A-0800-042-08R1-MS	10004245	8,0 0.315	42,0 1.654	91,0 3.583	55,0 2.165	36,0 1.417	53,0 2.087	8,0 0.315	140°	TiAIN + NbN	IT8-9
SD205A-0810-042-10R1-MS	10004246	8,1 0.319	42,0 1.654	103,0 4.055	63,0 2.480	40,0 1.575	61,0 2.402	10,0 0.394	140°	TiAIN + NbN	IT8-9
SD205A-0820-042-10R1-MS	10004247	8,2 0.323	42,0 1.654	103,0 4.055	63,0 2.480	40,0 1.575	61,0 2.402	10,0 0.394	140°	TiAIN + NbN	IT8-9
SD205A-0840-042-10R1-MS	10004250	8,4 0.331	42,0 1.654	103,0 4.055	63,0 2.480	40,0 1.575	61,0 2.402	10,0 0.394	140°	TiAIN + NbN	IT8-9
SD205A-0850-042-10R1-MS	10004251	8,5 0.335	42,0 1.654	103,0 4.055	63,0 2.480	40,0 1.575	61,0 2.402	10,0 0.394	140°	TiAIN + NbN	IT8-9
SD205A-0870-045-10R1-MS	10004252	8,7 0.343	45,0 1.772	103,0 4.055	63,0 2.480	40,0 1.575	61,0 2.402	10,0 0.394	140°	TiAIN + NbN	IT8-9
SD205A-0880-045-10R1-MS	10004255	8,8 0.346	45,0 1.772	103,0 4.055	63,0 2.480	40,0 1.575	61,0 2.402	10,0 0.394	140°	TiAIN + NbN	IT8-9
SD205A-0900-045-10R1-MS	10004256	9,0 0.354	45,0 1.772	103,0 4.055	63,0 2.480	40,0 1.575	61,0 2.402	10,0 0.394	140°	TiAIN + NbN	IT8-9
SD205A-0910-045-10R1-MS	10004257	9,1 0.358	45,0 1.772	103,0 4.055	63,0 2.480	40,0 1.575	61,0 2.402	10,0 0.394	140°	TiAIN + NbN	IT8-9
SD205A-0950-045-10R1-MS	10004258	9,5 0.374	45,0 1.772	103,0 4.055	63,0 2.480	40,0 1.575	61,0 2.402	10,0 0.394	140°	TiAIN + NbN	IT8-9
SD205A-0953-048-10R1-MS	10004259	9,53 0.375	48,0 1.890	103,0 4.055	63,0 2.480	40,0 1.575	61,0 2.402	10,0 0.394	140°	TiAIN + NbN	IT8-9
SD205A-0980-048-10R1-MS	10004266	9,8 0.386	48,0 1.890	103,0 4.055	63,0 2.480	40,0 1.575	61,0 2.402	10,0 0.394	140°	TiAIN + NbN	IT8-9
SD205A-0992-048-10R1-MS	10004269	9,92 0.391	48,0 1.890	103,0 4.055	63,0 2.480	40,0 1.575	61,0 2.402	10,0 0.394	140°	TiAIN + NbN	IT8-9
SD205A-1000-048-10R1-MS	10004270	10,0 0.394	48,0 1.890	103,0 4.055	63,0 2.480	40,0 1.575	61,0 2.402	10,0 0.394	140°	TiAIN + NbN	IT8-9
SD205A-1020-048-12R1-MS	10004272	10,2 0.402	48,0 1.890	118,0 4.646	73,0 2.874	45,0 1.772	71,0 2.795	12,0 0.472	140°	TiAIN + NbN	IT8-9
SD205A-1030-048-12R1-MS	10004273	10,3 0.406	48,0 1.890	118,0 4.646	73,0 2.874	45,0 1.772	71,0 2.795	12,0 0.472	140°	TiAIN + NbN	IT8-9
SD205A-1050-048-12R1-MS	10004274	10,5 0.413	48,0 1.890	118,0 4.646	73,0 2.874	45,0 1.772	71,0 2.795	12,0 0.472	140°	TiAIN + NbN	IT8-9
SD205A-1070-056-12R1-MS	10004275	10,7 0.421	56,0 2.205	118,0 4.646	73,0 2.874	45,0 1.772	71,0 2.795	12,0 0.472	140°	TiAIN + NbN	IT8-9
SD205A-1080-056-12R1-MS	10004276	10,8 0.425	56,0 2.205	118,0 4.646	73,0 2.874	45,0 1.772	71,0 2.795	12,0 0.472	140°	TiAIN + NbN	IT8-9
SD205A-1100-056-12R1-MS	10004277	11,0 0.433	56,0 2.205	118,0 4.646	73,0 2.874	45,0 1.772	71,0 2.795	12,0 0.472	140°	TiAIN + NbN	IT8-9
SD205A-1111-056-12R1-MS	10004278	11,11 0.437	56,0 2.205	118,0 4.646	73,0 2.874	45,0 1.772	71,0 2.795	12,0 0.472	140°	TiAIN + NbN	IT8-9
SD205A-1130-056-12R1-MS	10004279	11,3 0.445	56,0 2.205	118,0 4.646	73,0 2.874	45,0 1.772	71,0 2.795	12,0 0.472	140°	TiAIN + NbN	IT8-9
SD205A-1150-056-12R1-MS	10004280	11,5 0.453	56,0 2.205	118,0 4.646	73,0 2.874	45,0 1.772	71,0 2.795	12,0 0.472	140°	TiAIN + NbN	IT8-9
SD205A-1180-056-12R1-MS	10004281	11,8 0.465	56,0 2.205	118,0 4.646	73,0 2.874	45,0 1.772	71,0 2.795	12,0 0.472	140°	TiAIN + NbN	IT8-9
SD205A-1200-056-12R1-MS	10004282	12,0 0.472	56,0 2.205	118,0 4.646	73,0 2.874	45,0 1.772	71,0 2.795	12,0 0.472	140°	TiAIN + NbN	IT8-9
SD205A-1220-056-14R1-MS	10004283	12,2 0.480	56,0 2.205	124,0 4.882	79,0 3.110	45,0 1.772	77,0 3.031	14,0 0.551	140°	TiAIN + NbN	IT8-9
SD205A-1250-056-14R1-MS	10004284	12,5 0.492	56,0 2.205	124,0 4.882	79,0 3.110	45,0 1.772	77,0 3.031	14,0 0.551	140°	TiAIN + NbN	IT8-9
SD205A-1270-056-14R1-MS	10004285	12,7 0.500	56,0 2.205	124,0 4.882	79,0 3.110	45,0 1.772	77,0 3.031	14,0 0.551	140°	TiAIN + NbN	IT8-9

Wstęp

Wiercenie

Rozwiercanie

Wyłaczanie

Załącznik

Oznaczenie	Numer produktu	DC	LU	OAL	LFS	LS	LCF	DMM	Kąt wierzchołkowy	Pokrycie	Tolerancja otworu
		mm Cal.	mm Cal.	mm Cal.	mm Cal.	mm Cal.	mm Cal.	mm Cal.	mm Cal.		
SD205A-1300-056-14R1-MS	10004286	13,0 0.512	56,0 2.205	124,0 4.882	79,0 3.110	45,0 1.772	77,0 3.031	14,0 0.551	140°	TiAIN + NbN	IT8-9
SD205A-1310-056-14R1-MS	10004287	13,1 0.516	59,0 2.323	124,0 4.882	79,0 3.110	45,0 1.772	77,0 3.031	14,0 0.551	140°	TiAIN + NbN	IT8-9
SD205A-1350-059-14R1-MS	10004288	13,5 0.531	59,0 2.323	124,0 4.882	79,0 3.110	45,0 1.772	77,0 3.031	14,0 0.551	140°	TiAIN + NbN	IT8-9
SD205A-1400-059-14R1-MS	10004290	14,0 0.551	59,0 2.323	124,0 4.882	79,0 3.110	45,0 1.772	77,0 3.031	14,0 0.551	140°	TiAIN + NbN	IT8-9
SD205A-1420-060-16R1-MS	10004291	14,2 0.559	60,0 2.362	133,0 5.236	85,0 3.346	48,0 1.890	83,0 3.268	16,0 0.630	140°	TiAIN + NbN	IT8-9
SD205A-1425-060-16R1-MS	10004292	14,25 0.561	60,0 2.362	133,0 5.236	85,0 3.346	48,0 1.890	83,0 3.268	16,0 0.630	140°	TiAIN + NbN	IT8-9
SD205A-1450-060-16R1-MS	10004293	14,5 0.571	60,0 2.362	133,0 5.236	85,0 3.346	48,0 1.890	83,0 3.268	16,0 0.630	140°	TiAIN + NbN	IT8-9
SD205A-1500-060-16R1-MS	10004295	15,0 0.591	60,0 2.362	133,0 5.236	85,0 3.346	48,0 1.890	83,0 3.268	16,0 0.630	140°	TiAIN + NbN	IT8-9
SD205A-1550-062-16R1-MS	10004296	15,5 0.610	62,0 2.441	133,0 5.236	85,0 3.346	48,0 1.890	83,0 3.268	16,0 0.630	140°	TiAIN + NbN	IT8-9
SD205A-1580-062-16R1-MS	10004297	15,8 0.622	62,0 2.441	133,0 5.236	85,0 3.346	48,0 1.890	83,0 3.268	16,0 0.630	140°	TiAIN + NbN	IT8-9
SD205A-1600-062-16R1-MS	10004298	16,0 0.630	62,0 2.441	133,0 5.236	85,0 3.346	48,0 1.890	83,0 3.268	16,0 0.630	140°	TiAIN + NbN	IT8-9
SD205A-1650-071-18R1-MS	10004299	16,5 0.650	64,0 2.520	143,0 5.630	95,0 3.740	48,0 1.890	93,0 3.661	18,0 0.709	140°	TiAIN + NbN	IT8-9
SD205A-1700-071-18R1-MS	10004300	17,0 0.669	64,0 2.520	143,0 5.630	95,0 3.740	48,0 1.890	93,0 3.661	18,0 0.709	140°	TiAIN + NbN	IT8-9
SD205A-1750-071-18R1-MS	10004301	17,5 0.689	66,0 2.598	143,0 5.630	95,0 3.740	48,0 1.890	93,0 3.661	18,0 0.709	140°	TiAIN + NbN	IT8-9
SD205A-1800-071-18R1-MS	10004302	18,0 0.709	66,0 2.598	143,0 5.630	95,0 3.740	48,0 1.890	93,0 3.661	18,0 0.709	140°	TiAIN + NbN	IT8-9
SD205A-1850-077-20R1-MS	10004303	18,5 0.728	71,0 2.795	153,0 6.024	103,0 4.055	50,0 1.969	101,0 3.976	20,0 0.787	140°	TiAIN + NbN	IT8-9
SD205A-1900-077-20R1-MS	10004304	19,0 0.748	71,0 2.795	153,0 6.024	103,0 4.055	50,0 1.969	101,0 3.976	20,0 0.787	140°	TiAIN + NbN	IT8-9
SD205A-1930-077-20R1-MS	10004305	19,3 0.760	71,0 2.795	153,0 6.024	103,0 4.055	50,0 1.969	101,0 3.976	20,0 0.787	140°	TiAIN + NbN	IT8-9
SD205A-1950-077-20R1-MS	10004306	19,5 0.768	71,0 2.795	153,0 6.024	103,0 4.055	50,0 1.969	101,0 3.976	20,0 0.787	140°	TiAIN + NbN	IT8-9
SD205A-2000-077-20R1-MS	10004307	20,0 0.787	71,0 2.795	153,0 6.024	103,0 4.055	50,0 1.969	101,0 3.976	20,0 0.787	140°	TiAIN + NbN	IT8-9

SD203A, -M

Głębokość wiercenia ~ 3 x D – Metryczne/Calowe

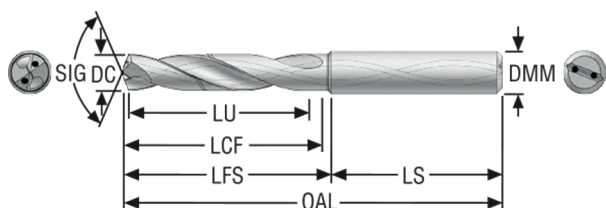

- Chwyt cylindryczny DIN 6537A
- Tolerancja DC m7
- Chłodzenie wewnętrzne
- Parametry skrawania, patrz strona (strony) 159-160
- Średnice pośrednie patrz aplikacja MyDesign.

Oznaczenie	Numer produktu	DC	LU	OAL	LFS	LS	LCF	DMM	Kąt wierzchołkowy	Pokrycie	Tolerancja otworu
		mm Cal.	mm Cal.	mm Cal.	mm Cal.	mm Cal.	mm Cal.	mm Cal.			
SD203A-3.0-14-6R1-M	02569995	3,0 0.118	14,0 0.551	62,0 2.441	26,0 1.024	36,0 1.417	20,0 0.787	6,0 0.236	140°	TiAIN + TiN	IT8-9
SD203A-3.1-14-6R1-M	02570998	3,1 0.122	14,0 0.551	62,0 2.441	26,0 1.024	36,0 1.417	20,0 0.787	6,0 0.236	140°	TiAIN + TiN	IT8-9
SD203A-3.3-14-6R1-M	02555958	3,3 0.130	14,0 0.551	62,0 2.441	26,0 1.024	36,0 1.417	20,0 0.787	6,0 0.236	140°	TiAIN + TiN	IT8-9
SD203A-3.4-14-6R1-M	02570984	3,4 0.134	14,0 0.551	62,0 2.441	26,0 1.024	36,0 1.417	20,0 0.787	6,0 0.236	140°	TiAIN + TiN	IT8-9
SD203A-3.5-15-6R1-M	02533784	3,5 0.138	15,0 0.591	62,0 2.441	26,0 1.024	36,0 1.417	20,0 0.787	6,0 0.236	140°	TiAIN + TiN	IT8-9
SD203A-3.9-17-6R1-M	02570988	3,9 0.154	17,0 0.669	66,0 2.598	30,0 1.181	36,0 1.417	24,0 0.945	6,0 0.236	140°	TiAIN + TiN	IT8-9
SD203A-4.0-17-6R1-M	02539902	4,0 0.157	17,0 0.669	66,0 2.598	30,0 1.181	36,0 1.417	24,0 0.945	6,0 0.236	140°	TiAIN + TiN	IT8-9
SD203A-4.2-17-6R1-M	02555959	4,2 0.165	17,0 0.669	66,0 2.598	30,0 1.181	36,0 1.417	24,0 0.945	6,0 0.236	140°	TiAIN + TiN	IT8-9
SD203A-4.3-18-6R1-M	02533700	4,3 0.169	18,0 0.709	66,0 2.598	30,0 1.181	36,0 1.417	24,0 0.945	6,0 0.236	140°	TiAIN + TiN	IT8-9
SD203A-4.5-18-6R1-M	02570993	4,5 0.177	18,0 0.709	66,0 2.598	30,0 1.181	36,0 1.417	24,0 0.945	6,0 0.236	140°	TiAIN + TiN	IT8-9
SD203A-01875-079-0236R1-M	02450103	4,763 0.188	20,0 0.787	66,0 2.598	30,0 1.181	36,0 1.417	28,0 1.102	6,0 0.236	140°	TiAIN + TiN	IT8-9
SD203A-4.8-20-6R1-M	02570982	4,8 0.189	20,0 0.787	66,0 2.598	30,0 1.181	36,0 1.417	28,0 1.102	6,0 0.236	140°	TiAIN + TiN	IT8-9
SD203A-4.9-20-6R1-M	02592709	4,9 0.193	20,0 0.787	66,0 2.598	30,0 1.181	36,0 1.417	28,0 1.102	6,0 0.236	140°	TiAIN + TiN	IT8-9
SD203A-5.0-20-6R1-M	02450075	5,0 0.197	20,0 0.787	66,0 2.598	30,0 1.181	36,0 1.417	28,0 1.102	6,0 0.236	140°	TiAIN + TiN	IT8-9
SD203A-5.5-21-6R1-M	02544249	5,5 0.217	20,0 0.787	66,0 2.598	30,0 1.181	36,0 1.417	28,0 1.102	6,0 0.236	140°	TiAIN + TiN	IT8-9
SD203A-02188-083-0236R1-M	02450104	5,558 0.219	20,0 0.787	66,0 2.598	30,0 1.181	36,0 1.417	28,0 1.102	6,0 0.236	140°	TiAIN + TiN	IT8-9
SD203A-5.6-21-6R1-M	02544028	5,6 0.220	21,0 0.827	66,0 2.598	30,0 1.181	36,0 1.417	28,0 1.102	6,0 0.236	140°	TiAIN + TiN	IT8-9
SD203A-5.9-21-6R1-M	02515290	5,9 0.232	21,0 0.827	66,0 2.598	30,0 1.181	36,0 1.417	28,0 1.102	6,0 0.236	140°	TiAIN + TiN	IT8-9
SD203A-6.0-21-6R1-M	02450076	6,0 0.236	21,0 0.827	66,0 2.598	30,0 1.181	36,0 1.417	28,0 1.102	6,0 0.236	140°	TiAIN + TiN	IT8-9
SD203A-02500-091-0315R1-M	02450105	6,35 0.250	23,0 0.906	79,0 3.110	43,0 1.693	36,0 1.417	34,0 1.339	8,0 0.315	140°	TiAIN + TiN	IT8-9
SD203A-6.5-23-8R1-M	02450077	6,5 0.256	23,0 0.906	79,0 3.110	43,0 1.693	36,0 1.417	34,0 1.339	8,0 0.315	140°	TiAIN + TiN	IT8-9

Oznaczenie	Numer produktu	DC	LU	OAL	LFS	LS	LCF	DMM	Kąt wierzchołkowy	Pokrycie	Tolerancja otworu
		mm Cal.	mm Cal.	mm Cal.	mm Cal.	mm Cal.	mm Cal.	mm Cal.			
SD203A-6.6-23-8R1-M	02450078	6,6 0.260	23,0 0.906	79,0 3.110	43,0 1.693	36,0 1.417	34,0 1.339	8,0 0.315	140°	TiAIN + TiN	IT8-9
SD203A-02656-098-0315R1-M	02450106	6,746 0.266	25,0 0.984	79,0 3.110	43,0 1.693	36,0 1.417	34,0 1.339	8,0 0.315	140°	TiAIN + TiN	IT8-9
SD203A-6.8-25-8R1-M	02450079	6,8 0.268	25,0 0.984	79,0 3.110	43,0 1.693	36,0 1.417	34,0 1.339	8,0 0.315	140°	TiAIN + TiN	IT8-9
SD203A-6.9-25-8R1-M	02450080	6,9 0.272	25,0 0.984	79,0 3.110	43,0 1.693	36,0 1.417	34,0 1.339	8,0 0.315	140°	TiAIN + TiN	IT8-9
SD203A-7.0-25-8R1-M	02450081	7,0 0.276	25,0 0.984	79,0 3.110	43,0 1.693	36,0 1.417	34,0 1.339	8,0 0.315	140°	TiAIN + TiN	IT8-9
SD203A-02813-098-0315R1-M	02450107	7,145 0.281	25,0 0.984	79,0 3.110	43,0 1.693	36,0 1.417	41,0 1.614	8,0 0.315	140°	TiAIN + TiN	IT8-9
SD203A-7.2-25-8R1-M	02537185	7,2 0.283	25,0 0.984	79,0 3.110	43,0 1.693	36,0 1.417	41,0 1.614	8,0 0.315	140°	TiAIN + TiN	IT8-9
SD203A-7.3-25-8R1-M	02530109	7,3 0.287	25,0 0.984	79,0 3.110	43,0 1.693	36,0 1.417	41,0 1.614	8,0 0.315	140°	TiAIN + TiN	IT8-9
SD203A-7.5-25-8R1-M	02450082	7,5 0.295	25,0 0.984	79,0 3.110	43,0 1.693	36,0 1.417	41,0 1.614	8,0 0.315	140°	TiAIN + TiN	IT8-9
SD203A-7.6-27-8R1-M	02545197	7,6 0.299	27,0 1.063	79,0 3.110	43,0 1.693	36,0 1.417	41,0 1.614	8,0 0.315	140°	TiAIN + TiN	IT8-9
SD203A-7.8-27-8R1-M	02450083	7,8 0.307	27,0 1.063	79,0 3.110	43,0 1.693	36,0 1.417	41,0 1.614	8,0 0.315	140°	TiAIN + TiN	IT8-9
SD203A-03125-106-0315R1-M	02450108	7,938 0.313	27,0 1.063	79,0 3.110	43,0 1.693	36,0 1.417	41,0 1.614	8,0 0.315	140°	TiAIN + TiN	IT8-9
SD203A-8.0-27-8R1-M	02450084	8,0 0.315	27,0 1.063	79,0 3.110	43,0 1.693	36,0 1.417	41,0 1.614	8,0 0.315	140°	TiAIN + TiN	IT8-9
SD203A-8.5-27-10R1-M	02450085	8,5 0.335	27,0 1.063	89,0 3.504	49,0 1.929	40,0 1.575	47,0 1.850	10,0 0.394	140°	TiAIN + TiN	IT8-9
SD203A-03438-114-0394R1-M	02450109	8,733 0.344	29,0 1.142	89,0 3.504	49,0 1.929	40,0 1.575	47,0 1.850	10,0 0.394	140°	TiAIN + TiN	IT8-9
SD203A-8.8-29-10R1-M	02450086	8,8 0.346	29,0 1.142	89,0 3.504	49,0 1.929	40,0 1.575	47,0 1.850	10,0 0.394	140°	TiAIN + TiN	IT8-9
SD203A-9.0-29-10R1-M	02450087	9,0 0.354	29,0 1.142	89,0 3.504	49,0 1.929	40,0 1.575	47,0 1.850	10,0 0.394	140°	TiAIN + TiN	IT8-9
SD203A-03594-114-0394R1-M	02450110	9,129 0.359	29,0 1.142	89,0 3.504	49,0 1.929	40,0 1.575	47,0 1.850	10,0 0.394	140°	TiAIN + TiN	IT8-9
SD203A-9.2-29-10R1-M	02546516	9,2 0.362	29,0 1.142	89,0 3.504	49,0 1.929	40,0 1.575	47,0 1.850	10,0 0.394	140°	TiAIN + TiN	IT8-9
SD203A-9.3-29-10R1-M	02582375	9,3 0.366	29,0 1.142	89,0 3.504	49,0 1.929	40,0 1.575	47,0 1.850	10,0 0.394	140°	TiAIN + TiN	IT8-9
SD203A-9.5-29-10R1-M	02450088	9,5 0.374	29,0 1.142	89,0 3.504	49,0 1.929	40,0 1.575	47,0 1.850	10,0 0.394	140°	TiAIN + TiN	IT8-9
SD203A-03750-122-0394R1-M	02450111	9,525 0.375	29,0 1.142	89,0 3.504	49,0 1.929	40,0 1.575	47,0 1.850	10,0 0.394	140°	TiAIN + TiN	IT8-9
SD203A-9.8-31-10R1-M	02450089	9,8 0.386	31,0 1.220	89,0 3.504	49,0 1.929	40,0 1.575	47,0 1.850	10,0 0.394	140°	TiAIN + TiN	IT8-9
SD203A-9.9-31-10R1-M	02515293	9,9 0.390	31,0 1.220	89,0 3.504	49,0 1.929	40,0 1.575	47,0 1.850	10,0 0.394	140°	TiAIN + TiN	IT8-9
SD203A-10.0-31-10R1-M	02450090	10,0 0.394	31,0 1.220	89,0 3.504	49,0 1.929	40,0 1.575	47,0 1.850	10,0 0.394	140°	TiAIN + TiN	IT8-9
SD203A-10.2-31-12R1-M	02450091	10,2 0.402	31,0 1.220	102,0 4.016	57,0 2.244	45,0 1.772	55,0 2.165	12,0 0.472	140°	TiAIN + TiN	IT8-9
SD203A-04063-122-0472R1-M	02450112	10,32 0.406	31,0 1.220	102,0 4.016	57,0 2.244	45,0 1.772	55,0 2.165	12,0 0.472	140°	TiAIN + TiN	IT8-9
SD203A-10.4-31-12R1-M	02535267	10,4 0.409	31,0 1.220	102,0 4.016	57,0 2.244	45,0 1.772	55,0 2.165	12,0 0.472	140°	TiAIN + TiN	IT8-9
SD203A-10.5-31-12R1-M	02450092	10,5 0.413	31,0 1.220	102,0 4.016	57,0 2.244	45,0 1.772	55,0 2.165	12,0 0.472	140°	TiAIN + TiN	IT8-9
SD203A-04219-130-0472R1-M	02450113	10,716 0.422	33,0 1.299	102,0 4.016	57,0 2.244	45,0 1.772	55,0 2.165	12,0 0.472	140°	TiAIN + TiN	IT8-9
SD203A-10.8-33-12R1-M	02450093	10,8 0.425	33,0 1.299	102,0 4.016	57,0 2.244	45,0 1.772	55,0 2.165	12,0 0.472	140°	TiAIN + TiN	IT8-9

Wstęp

Wiercenie

Rozwiercanie

Wyłaczanie

Załącznik

Oznaczenie	Numer produktu	DC	LU	OAL	LFS	LS	LCF	DMM	Kąt wierzchołkowy	Pokrycie	Tolerancja otworu
		mm Cal.	mm Cal.	mm Cal.	mm Cal.	mm Cal.	mm Cal.	mm Cal.			
SD203A-11.0-33-12R1-M	02450094	11,0 0.433	33,0 1.299	102,0 4.016	57,0 2.244	45,0 1.772	55,0 2.165	12,0 0.472	140°	TiAIN + TiN	IT8-9
SD203A-04375-130-0472R1-M	02450114	11,113 0.438	33,0 1.299	102,0 4.016	57,0 2.244	45,0 1.772	55,0 2.165	12,0 0.472	140°	TiAIN + TiN	IT8-9
SD203A-11.5-33-12R1-M	02450095	11,5 0.453	33,0 1.299	102,0 4.016	57,0 2.244	45,0 1.772	55,0 2.165	12,0 0.472	140°	TiAIN + TiN	IT8-9
SD203A-11.8-33-12R1-M	02450096	11,8 0.465	33,0 1.299	102,0 4.016	57,0 2.244	45,0 1.772	55,0 2.165	12,0 0.472	140°	TiAIN + TiN	IT8-9
SD203A-04688-142-0472R1-M	02592711	11,908 0.469	36,0 1.417	102,0 4.016	57,0 2.244	45,0 1.772	55,0 2.165	12,0 0.472	140°	TiAIN + TiN	IT8-9
SD203A-12.0-36-12R1-M	02450097	12,0 0.472	36,0 1.417	102,0 4.016	57,0 2.244	45,0 1.772	55,0 2.165	12,0 0.472	140°	TiAIN + TiN	IT8-9
SD203A-12.25-36-14R1-M	02592712	12,25 0.482	36,0 1.417	107,0 4.213	62,0 2.441	45,0 1.772	60,0 2.362	14,0 0.551	140°	TiAIN + TiN	IT8-9
SD203A-12.3-36-14R1-M	02450098	12,3 0.484	36,0 1.417	107,0 4.213	62,0 2.441	45,0 1.772	60,0 2.362	14,0 0.551	140°	TiAIN + TiN	IT8-9
SD203A-12.5-36-14R1-M	02450099	12,5 0.492	36,0 1.417	107,0 4.213	62,0 2.441	45,0 1.772	60,0 2.362	14,0 0.551	140°	TiAIN + TiN	IT8-9
SD203A-05000-142-0551R1-M	02450115	12,7 0.500	36,0 1.417	107,0 4.213	62,0 2.441	45,0 1.772	60,0 2.362	14,0 0.551	140°	TiAIN + TiN	IT8-9
SD203A-12.9-36-14R1-M	02538263	12,9 0.508	36,0 1.417	107,0 4.213	62,0 2.441	45,0 1.772	60,0 2.362	14,0 0.551	140°	TiAIN + TiN	IT8-9
SD203A-13.0-36-14R1-M	02450100	13,0 0.512	36,0 1.417	107,0 4.213	62,0 2.441	45,0 1.772	60,0 2.362	14,0 0.551	140°	TiAIN + TiN	IT8-9
SD203A-13.5-37-14R1-M	02450101	13,5 0.531	37,0 1.457	107,0 4.213	62,0 2.441	45,0 1.772	60,0 2.362	14,0 0.551	140°	TiAIN + TiN	IT8-9
SD203A-14.0-37-14R1-M	02450102	14,0 0.551	37,0 1.457	107,0 4.213	62,0 2.441	45,0 1.772	60,0 2.362	14,0 0.551	140°	TiAIN + TiN	IT8-9
SD203A-14.25-38-16R1-M	02592715	14,25 0.561	38,0 1.496	115,0 4.528	67,0 2.638	48,0 1.890	65,0 2.559	16,0 0.630	140°	TiAIN + TiN	IT8-9

SD205A, -M

Głębokość wiercenia ~ 5 x D – Metryczne/Calowe

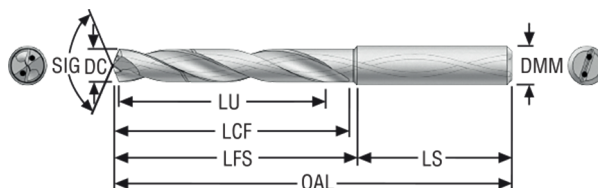

- Chwył cylindryczny DIN 6537A
- Tolerancja DC m7
- Chłodzenie wewnętrzne
- Parametry skrawania, patrz strona (strony) 161- 162
- Średnice pośrednie patrz aplikacja MyDesign.

Oznaczenie	Numer produktu	DC	LU	OAL	LFS	LS	LCF	DMM	Kąt wierzchołkowy	Pokrycie	Tolerancja otworu
		mm Cal.	mm Cal.	mm Cal.	mm Cal.	mm Cal.	mm Cal.	mm Cal.			
SD205A-2.5-13-4R1-M	02666989	2,5 0.098	13,0 0.512	46,0 1.811	19,0 0.748	27,0 1.063	17,5 0.689	4,0 0.157	140°	TiAIN + TiN	IT8-9
SD205A-3.0-21-6R1-M	02556426	3,0 0.118	21,0 0.827	66,0 2.598	30,0 1.181	36,0 1.417	26,0 1.024	6,0 0.236	140°	TiAIN + TiN	IT8-9
SD205A-3.1-21-6R1-M	02642448	3,1 0.122	21,0 0.827	66,0 2.598	30,0 1.181	36,0 1.417	26,0 1.024	6,0 0.236	140°	TiAIN + TiN	IT8-9
SD205A-3.18-21-6R1-M	02541863	3,18 0.125	21,0 0.827	66,0 2.598	30,0 1.181	36,0 1.417	26,0 1.024	6,0 0.236	140°	TiAIN + TiN	IT8-9
SD205A-3.3-21-6R1-M	02555960	3,3 0.130	21,0 0.827	66,0 2.598	30,0 1.181	36,0 1.417	26,0 1.024	6,0 0.236	140°	TiAIN + TiN	IT8-9
SD205A-3.4-21-6R1-M	02554264	3,4 0.134	21,0 0.827	66,0 2.598	30,0 1.181	36,0 1.417	26,0 1.024	6,0 0.236	140°	TiAIN + TiN	IT8-9
SD205A-3.5-21-6R1-M	02533780	3,5 0.138	21,0 0.827	66,0 2.598	30,0 1.181	36,0 1.417	26,0 1.024	6,0 0.236	140°	TiAIN + TiN	IT8-9
SD205A-4.0-27-6R1-M	02508340	4,0 0.157	27,0 1.063	74,0 2.913	38,0 1.496	36,0 1.417	34,0 1.339	6,0 0.236	140°	TiAIN + TiN	IT8-9
SD205A-4.2-27-6R1-M	02502549	4,2 0.165	27,0 1.063	74,0 2.913	40,0 1.575	36,0 1.417	34,0 1.339	6,0 0.236	140°	TiAIN + TiN	IT8-9
SD205A-4.3-27-6R1-M	02592718	4,3 0.169	27,0 1.063	74,0 2.913	38,0 1.496	36,0 1.417	34,0 1.339	6,0 0.236	140°	TiAIN + TiN	IT8-9
SD205A-4.5-27-6R1-M	02563659	4,5 0.177	27,0 1.063	74,0 2.913	38,0 1.496	36,0 1.417	34,0 1.339	6,0 0.236	140°	TiAIN + TiN	IT8-9
SD205A-4.7-27-6R1-M	02604031	4,7 0.185	27,0 1.063	74,0 2.913	40,0 1.575	36,0 1.417	34,0 1.339	6,0 0.236	140°	TiAIN + TiN	IT8-9
SD205A-01875-126-0236R1-M	02450062	4,763 0.188	32,0 1.260	82,0 3.228	46,0 1.811	36,0 1.417	44,0 1.732	6,0 0.236	140°	TiAIN + TiN	IT8-9
SD205A-4.9-32-6R1-M	02592720	4,9 0.193	32,0 1.260	82,0 3.228	46,0 1.811	36,0 1.417	44,0 1.732	6,0 0.236	140°	TiAIN + TiN	IT8-9
SD205A-5.0-32-6R1-M	02450034	5,0 0.197	32,0 1.260	82,0 3.228	46,0 1.811	36,0 1.417	44,0 1.732	6,0 0.236	140°	TiAIN + TiN	IT8-9
SD205A-5.1-32-6R1-M	02600034	5,1 0.201	32,0 1.260	82,0 3.228	46,0 1.811	36,0 1.417	44,0 1.732	6,0 0.236	140°	TiAIN + TiN	IT8-9
SD205A-5.2-32-6R1-M	02504408	5,2 0.205	32,0 1.260	82,0 3.228	46,0 1.811	36,0 1.417	44,0 1.732	6,0 0.236	140°	TiAIN + TiN	IT8-9
SD205A-5.5-32-6R1-M	02537341	5,5 0.217	32,0 1.260	82,0 3.228	46,0 1.811	36,0 1.417	44,0 1.732	6,0 0.236	140°	TiAIN + TiN	IT8-9
SD205A-02188-126-0236R1-M	02450063	5,558 0.219	32,0 1.260	82,0 3.228	46,0 1.811	36,0 1.417	44,0 1.732	6,0 0.236	140°	TiAIN + TiN	IT8-9
SD205A-5.6-32-6R1-M	02612445	5,6 0.220	32,0 1.260	82,0 3.228	46,0 1.811	36,0 1.417	44,0 1.732	6,0 0.236	140°	TiAIN + TiN	IT8-9
SD205A-5.9-32-6R1-M	02539334	5,9 0.232	32,0 1.260	82,0 3.228	46,0 1.811	36,0 1.417	44,0 1.732	6,0 0.236	140°	TiAIN + TiN	IT8-9
SD205A-6.0-32-6R1-M	02450035	6,0 0.236	32,0 1.260	82,0 3.228	46,0 1.811	36,0 1.417	44,0 1.732	6,0 0.236	140°	TiAIN + TiN	IT8-9

Oznaczenie	Numer produktu	DC	LU	OAL	LFS	LS	LCF	DMM	Kąt wierzchołkowy	Pokrycie	Tolerancja otworu
		mm Cal.	mm Cal.	mm Cal.	mm Cal.	mm Cal.	mm Cal.	mm Cal.	mm Cal.		
SD205A-6.2-35-8R1-M	02547543	6,2 0.244	35,0 1.378	91,0 3.583	55,0 2.165	36,0 1.417	53,0 2.087	8,0 0.315	140°	TiAIN + TiN	IT8-9
SD205A-02500-138-0315R1-M	02450064	6,35 0.250	35,0 1.378	91,0 3.583	55,0 2.165	36,0 1.417	53,0 2.087	8,0 0.315	140°	TiAIN + TiN	IT8-9
SD205A-6.4-35-8R1-M	02666488	6,4 0.252	35,0 1.378	91,0 3.583	55,0 2.165	36,0 1.417	53,0 2.087	8,0 0.315	140°	TiAIN + TiN	IT8-9
SD205A-6.5-35-8R1-M	02450036	6,5 0.256	35,0 1.378	91,0 3.583	55,0 2.165	36,0 1.417	53,0 2.087	8,0 0.315	140°	TiAIN + TiN	IT8-9
SD205A-6.6-35-8R1-M	02450037	6,6 0.260	35,0 1.378	91,0 3.583	55,0 2.165	36,0 1.417	53,0 2.087	8,0 0.315	140°	TiAIN + TiN	IT8-9
SD205A-6.8-40-8R1-M	02450038	6,8 0.268	40,0 1.575	91,0 3.583	55,0 2.165	36,0 1.417	53,0 2.087	8,0 0.315	140°	TiAIN + TiN	IT8-9
SD205A-6.9-40-8R1-M	02450039	6,9 0.272	40,0 1.575	91,0 3.583	55,0 2.165	36,0 1.417	53,0 2.087	8,0 0.315	140°	TiAIN + TiN	IT8-9
SD205A-02813-157-0315R1-M	02450066	7,145 0.281	40,0 1.575	91,0 3.583	55,0 2.165	36,0 1.417	53,0 2.087	8,0 0.315	140°	TiAIN + TiN	IT8-9
SD205A-7.2-40-8R1-M	02519059	7,2 0.283	40,0 1.575	91,0 3.583	55,0 2.165	36,0 1.417	53,0 2.087	8,0 0.315	140°	TiAIN + TiN	IT8-9
SD205A-7.5-40-8R1-M	02450041	7,5 0.295	40,0 1.575	91,0 3.583	55,0 2.165	36,0 1.417	53,0 2.087	8,0 0.315	140°	TiAIN + TiN	IT8-9
SD205A-7.8-42-8R1-M	02450042	7,8 0.307	42,0 1.654	91,0 3.583	55,0 2.165	36,0 1.417	53,0 2.087	8,0 0.315	140°	TiAIN + TiN	IT8-9
SD205A-03125-165-0315R1-M	02450067	7,938 0.313	42,0 1.654	91,0 3.583	55,0 2.165	36,0 1.417	53,0 2.087	8,0 0.315	140°	TiAIN + TiN	IT8-9
SD205A-8.0-42-8R1-M	02450043	8,0 0.315	42,0 1.654	91,0 3.583	55,0 2.165	36,0 1.417	53,0 2.087	8,0 0.315	140°	TiAIN + TiN	IT8-9
SD205A-8.1-42-10R1-M	02672327	8,1 0.319	42,0 1.654	103,0 4.055	63,0 2.480	40,0 1.575	61,0 2.402	10,0 0.394	140°	TiAIN + TiN	IT8-9
SD205A-8.4-42-10R1-M	02570977	8,4 0.331	42,0 1.654	103,0 4.055	63,0 2.480	40,0 1.575	61,0 2.402	10,0 0.394	140°	TiAIN + TiN	IT8-9
SD205A-8.5-42-10R1-M	02450044	8,5 0.335	42,0 1.654	103,0 4.055	63,0 2.480	40,0 1.575	61,0 2.402	10,0 0.394	140°	TiAIN + TiN	IT8-9
SD205A-8.8-45-10R1-M	02450045	8,8 0.346	45,0 1.772	103,0 4.055	63,0 2.480	40,0 1.575	61,0 2.402	10,0 0.394	140°	TiAIN + TiN	IT8-9
SD205A-9.0-45-10R1-M	02450046	9,0 0.354	45,0 1.772	103,0 4.055	63,0 2.480	40,0 1.575	61,0 2.402	10,0 0.394	140°	TiAIN + TiN	IT8-9
SD205A-9.2-45-10R1-M	02516406	9,2 0.362	45,0 1.772	103,0 4.055	63,0 2.480	40,0 1.575	61,0 2.402	10,0 0.394	140°	TiAIN + TiN	IT8-9
SD205A-9.5-45-10R1-M	02450047	9,5 0.374	45,0 1.772	103,0 4.055	63,0 2.480	40,0 1.575	61,0 2.402	10,0 0.394	140°	TiAIN + TiN	IT8-9
SD205A-03750-189-0394R1-M	02450070	9,525 0.375	48,0 1.890	103,0 4.055	63,0 2.480	40,0 1.575	61,0 2.402	10,0 0.394	140°	TiAIN + TiN	IT8-9
SD205A-9.8-48-10R1-M	02450048	9,8 0.386	48,0 1.890	103,0 4.055	63,0 2.480	40,0 1.575	61,0 2.402	10,0 0.394	140°	TiAIN + TiN	IT8-9
SD205A-10.0-48-10R1-M	02450049	10,0 0.394	48,0 1.890	103,0 4.055	63,0 2.480	40,0 1.575	61,0 2.402	10,0 0.394	140°	TiAIN + TiN	IT8-9
SD205A-10.2-48-12R1-M	02450050	10,2 0.402	48,0 1.890	118,0 4.646	73,0 2.874	45,0 1.772	71,0 2.795	12,0 0.472	140°	TiAIN + TiN	IT8-9
SD205A-10.5-48-12R1-M	02450051	10,5 0.413	48,0 1.890	118,0 4.646	73,0 2.874	45,0 1.772	71,0 2.795	12,0 0.472	140°	TiAIN + TiN	IT8-9
SD205A-10.8-56-12R1-M	02450052	10,8 0.425	56,0 2.205	118,0 4.646	73,0 2.874	45,0 1.772	71,0 2.795	12,0 0.472	140°	TiAIN + TiN	IT8-9
SD205A-10.9-56-12R1-M	02592725	10,9 0.429	56,0 2.205	118,0 4.646	73,0 2.874	45,0 1.772	71,0 2.795	12,0 0.472	140°	TiAIN + TiN	IT8-9
SD205A-11.0-56-12R1-M	02450053	11,0 0.433	56,0 2.205	118,0 4.646	73,0 2.874	45,0 1.772	71,0 2.795	12,0 0.472	140°	TiAIN + TiN	IT8-9
SD205A-04375-221-0472R1-M	02450073	11,113 0.438	56,0 2.205	118,0 4.646	73,0 2.874	45,0 1.772	71,0 2.795	12,0 0.472	140°	TiAIN + TiN	IT8-9
SD205A-11.5-56-12R1-M	02450054	11,5 0.453	56,0 2.205	118,0 4.646	73,0 2.874	45,0 1.772	71,0 2.795	12,0 0.472	140°	TiAIN + TiN	IT8-9
SD205A-11.8-56-12R1-M	02450055	11,8 0.465	56,0 2.205	118,0 4.646	73,0 2.874	45,0 1.772	71,0 2.795	12,0 0.472	140°	TiAIN + TiN	IT8-9

Oznaczenie	Numer produktu	DC	LU	OAL	LFS	LS	LCF	DMM	Kąt wierzchołkowy	Pokrycie	Tolerancja otworu
		mm Cal.	mm Cal.	mm Cal.	mm Cal.	mm Cal.	mm Cal.	mm Cal.			
SD205A-12.0-56-12R1-M	02450056	12,0 0.472	56,0 2.205	118,0 4.646	73,0 2.874	45,0 1.772	71,0 2.795	12,0 0.472	140°	TiAIN + TiN	IT8-9
SD205A-12.5-56-14R1-M	02450058	12,5 0.492	56,0 2.205	124,0 4.882	79,0 3.110	45,0 1.772	77,0 3.031	14,0 0.551	140°	TiAIN + TiN	IT8-9
SD205A-05000-221-0551R1-M	02450074	12,7 0.500	56,0 2.205	124,0 4.882	79,0 3.110	45,0 1.772	77,0 3.031	14,0 0.551	140°	TiAIN + TiN	IT8-9
SD205A-12.9-56-14R1-M	02592729	12,9 0.508	56,0 2.205	124,0 4.882	79,0 3.110	45,0 1.772	77,0 3.031	14,0 0.551	140°	TiAIN + TiN	IT8-9
SD205A-13.0-56-14R1-M	02450059	13,0 0.512	56,0 2.205	124,0 4.882	79,0 3.110	45,0 1.772	77,0 3.031	14,0 0.551	140°	TiAIN + TiN	IT8-9
SD205A-13.5-59-14R1-M	02450060	13,5 0.531	59,0 2.323	124,0 4.882	79,0 3.110	45,0 1.772	77,0 3.031	14,0 0.551	140°	TiAIN + TiN	IT8-9
SD205A-14.0-59-14R1-M	02450061	14,0 0.551	59,0 2.323	124,0 4.882	79,0 3.110	45,0 1.772	77,0 3.031	14,0 0.551	140°	TiAIN + TiN	IT8-9
SD205A-14.25-60-16R1-M	02592732	14,25 0.561	60,0 2.362	133,0 5.236	85,0 3.346	48,0 1.890	83,0 3.268	16,0 0.630	140°	TiAIN + TiN	IT8-9
SD205A-14.5-60-16R1-M	03117534	14,5 0.571	60,0 2.362	133,0 5.236	85,0 3.346	48,0 1.890	83,0 3.268	16,0 0.630	140°	TiAIN + TiN	IT8-9
SD205A-15.0-60-16R1-M	02570652	15,0 0.591	60,0 2.362	133,0 5.236	85,0 3.346	48,0 1.890	83,0 3.268	16,0 0.630	140°	TiAIN + TiN	IT8-9
SD205A-15.5-62-16R1-M	02543076	15,5 0.610	62,0 2.441	133,0 5.236	85,0 3.346	48,0 1.890	83,0 3.268	16,0 0.630	140°	TiAIN + TiN	IT8-9
SD205A-16.0-62-16R1-M	02555961	16,0 0.630	62,0 2.441	133,0 5.236	85,0 3.346	48,0 1.890	83,0 3.268	16,0 0.630	140°	TiAIN + TiN	IT8-9

Wstęp

Wiercenie

Rozwiercanie

Wytaczanie

Załącznik

SD203A, -T

Głębokość wiercenia ~ 3 x D – Metryczne/Calowe

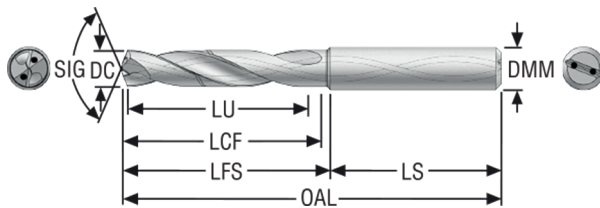

- Chwyt cylindryczny DIN 6537A
- Tolerancja DC m7
- Chłodzenie wewnętrzne
- Parametry skrawania - www.secotools.com
- Średnice pośrednie patrz aplikacja MyDesign.

Oznaczenie	Numer produktu	DC	LU	OAL	LFS	LS	LCF	DMM	Kąt wierzchołkowy	Pokrycie	Tolerancja otworu
		mm Cal.	mm Cal.	mm Cal.	mm Cal.	mm Cal.	mm Cal.	mm Cal.			
SD203A-01875-079-0236R1-T	02569147	4,763 0.188	20,0 0.787	66,0 2.598	30,0 1.181	36,0 1.417	28,0 1.102	6,0 0.236	140°	Niepokr.	IT8-9
SD203A-5.0-20-6R1-T	02523021	5,0 0.197	20,0 0.787	66,0 2.598	30,0 1.181	36,0 1.417	28,0 1.102	6,0 0.236	140°	Niepokr.	IT8-9
SD203A-02188-083-0236R1-T	02569156	5,558 0.219	20,0 0.787	66,0 2.598	30,0 1.181	36,0 1.417	28,0 1.102	6,0 0.236	140°	Niepokr.	IT8-9
SD203A-6.0-21-6R1-T	02542682	6,0 0.236	21,0 0.827	66,0 2.598	30,0 1.181	36,0 1.417	28,0 1.102	6,0 0.236	140°	Niepokr.	IT8-9
SD203A-02500-091-0315R1-T	02569149	6,35 0.250	23,0 0.906	79,0 3.110	43,0 1.693	36,0 1.417	34,0 1.339	8,0 0.315	140°	Niepokr.	IT8-9
SD203A-6.5-23-8R1-T	02545316	6,5 0.256	23,0 0.906	79,0 3.110	43,0 1.693	36,0 1.417	34,0 1.339	8,0 0.315	140°	Niepokr.	IT8-9
SD203A-6.9-25-8R1-T	02537280	6,9 0.272	25,0 0.984	79,0 3.110	43,0 1.693	36,0 1.417	34,0 1.339	8,0 0.315	140°	Niepokr.	IT8-9
SD203A-7.0-25-8R1-T	02525985	7,0 0.276	25,0 0.984	79,0 3.110	43,0 1.693	36,0 1.417	34,0 1.339	8,0 0.315	140°	Niepokr.	IT8-9
SD203A-02813-098-0315R1-T	02569151	7,145 0.281	25,0 0.984	79,0 3.110	43,0 1.693	36,0 1.417	41,0 1.614	8,0 0.315	140°	Niepokr.	IT8-9
SD203A-7.5-25-8R1-T	02527667	7,5 0.295	25,0 0.984	79,0 3.110	43,0 1.693	36,0 1.417	41,0 1.614	8,0 0.315	140°	Niepokr.	IT8-9
SD203A-03125-106-0315R1-T	02569152	7,938 0.313	27,0 1.063	79,0 3.110	43,0 1.693	36,0 1.417	41,0 1.614	8,0 0.315	140°	Niepokr.	IT8-9
SD203A-8.0-27-8R1-T	02513679	8,0 0.315	27,0 1.063	79,0 3.110	43,0 1.693	36,0 1.417	41,0 1.614	8,0 0.315	140°	Niepokr.	IT8-9
SD203A-8.5-27-10R1-T	02548250	8,5 0.335	27,0 1.063	89,0 3.504	49,0 1.929	40,0 1.575	47,0 1.850	10,0 0.394	140°	Niepokr.	IT8-9
SD203A-8.8-29-10R1-T	02569153	8,8 0.346	29,0 1.142	89,0 3.504	49,0 1.929	40,0 1.575	47,0 1.850	10,0 0.394	140°	Niepokr.	IT8-9
SD203A-9.0-29-10R1-T	02524440	9,0 0.354	29,0 1.142	89,0 3.504	49,0 1.929	40,0 1.575	47,0 1.850	10,0 0.394	140°	Niepokr.	IT8-9
SD203A-9.5-29-10R1-T	02545386	9,5 0.374	29,0 1.142	89,0 3.504	49,0 1.929	40,0 1.575	47,0 1.850	10,0 0.394	140°	Niepokr.	IT8-9
SD203A-10.0-31-10R1-T	02525984	10,0 0.394	31,0 1.220	89,0 3.504	49,0 1.929	40,0 1.575	47,0 1.850	10,0 0.394	140°	Niepokr.	IT8-9
SD203A-10.5-31-12R1-T	02545387	10,5 0.413	31,0 1.220	102,0 4.016	57,0 2.244	45,0 1.772	55,0 2.165	12,0 0.472	140°	Niepokr.	IT8-9
SD203A-11.0-33-12R1-T	02569155	11,0 0.433	33,0 1.299	102,0 4.016	57,0 2.244	45,0 1.772	55,0 2.165	12,0 0.472	140°	Niepokr.	IT8-9
SD203A-11.5-33-12R1-T	02567385	11,5 0.453	33,0 1.299	102,0 4.016	57,0 2.244	45,0 1.772	55,0 2.165	12,0 0.472	140°	Niepokr.	IT8-9
SD203A-12.0-36-12R1-T	02562784	12,0 0.472	36,0 1.417	102,0 4.016	57,0 2.244	45,0 1.772	55,0 2.165	12,0 0.472	140°	Niepokr.	IT8-9

SD205A, -T

Głębokość wiercenia ~ 5 x D – Metryczne/Calowe

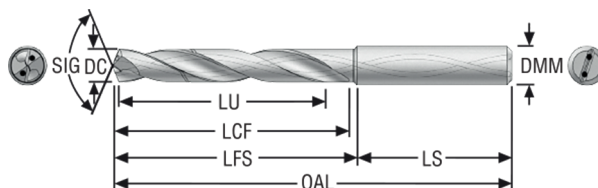

- Chwył cylindryczny DIN 6537A
- Tolerancja DC m7
- Chłodzenie wewnętrzne
- Parametry skrawania - www.secotools.com
- Średnice pośrednie patrz aplikacja MyDesign.

Oznaczenie	Numer produktu	DC	LU	OAL	LFS	LS	LCF	DMM	Kąt wierzchołkowy	Pokrycie	Tolerancja otworu
		mm Cal.	mm Cal.	mm Cal.	mm Cal.	mm Cal.	mm Cal.	mm Cal.			
SD205A-8.0-42-8R1-T	02569164	8,0 0.315	42,0 1.654	91,0 3.583	55,0 2.165	36,0 1.417	53,0 2.087	8,0 0.315	140°	Niepokr.	IT8-9
SD205A-12.0-56-12R1-T	02527621	12,0 0.472	56,0 2.205	118,0 4.646	73,0 2.874	45,0 1.772	71,0 2.795	12,0 0.472	140°	Niepokr.	IT8-9

Wstęp

Wiercenie

Rozwiercanie

Wytaczanie

Załącznik

SD203A, -N

Głębokość wiercenia ~ 3 x D – Metryczne/Calowe

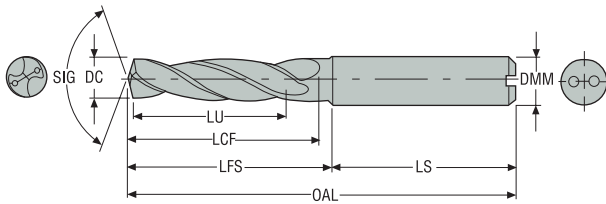

- Chwyt cylindryczny DIN 6537A
- Tolerancja DC m7
- Chłodzenie wewnętrzne
- Parametry skrawania, patrz strona (strony) 144- 145
- Średnice pośrednie patrz aplikacja MyDesign.

Oznaczenie	Numer produktu	DC	LU	OAL	LFS	LS	LCF	DMM	Kąt wierzchołkowy	Pokrycie	Tolerancja otworu
		mm Cal.	mm Cal.	mm Cal.	mm Cal.	mm Cal.	mm Cal.	mm Cal.			
SD203A-2.5-8-4R1-N	02691548	2,5 0.098	8,0 0.315	44,0 1.732	16,0 0.630	28,0 1.102	13,0 0.512	4,0 0.157	140°	Pokrycie DLC	IT8-9
SD203A-3.0-14-6R1-N	02691549	3,0 0.118	14,0 0.551	62,0 2.441	26,0 1.024	36,0 1.417	20,0 0.787	6,0 0.236	140°	Pokrycie DLC	IT8-9
SD203A-3.3-14-6R1-N	02691551	3,3 0.130	14,0 0.551	62,0 2.441	26,0 1.024	36,0 1.417	20,0 0.787	6,0 0.236	140°	Pokrycie DLC	IT8-9
SD203A-3.5-15-6R1-N	02691552	3,5 0.138	15,0 0.591	62,0 2.441	26,0 1.024	36,0 1.417	20,0 0.787	6,0 0.236	140°	Pokrycie DLC	IT8-9
SD203A-4.0-17-6R1-N	02691553	4,0 0.157	17,0 0.669	66,0 2.598	30,0 1.181	36,0 1.417	24,0 0.945	6,0 0.236	140°	Pokrycie DLC	IT8-9
SD203A-4.1-17-6R1-N	02691554	4,1 0.161	17,0 0.669	66,0 2.598	30,0 1.181	36,0 1.417	24,0 0.945	6,0 0.236	140°	Pokrycie DLC	IT8-9
SD203A-4.5-18-6R1-N	02691555	4,5 0.177	18,0 0.709	66,0 2.598	30,0 1.181	36,0 1.417	24,0 0.945	6,0 0.236	140°	Pokrycie DLC	IT8-9
SD203A-5.0-20-6R1-N	02691556	5,0 0.197	20,0 0.787	66,0 2.598	30,0 1.181	36,0 1.417	28,0 1.102	6,0 0.236	140°	Pokrycie DLC	IT8-9
SD203A-5.2-20-6R1-N	02691557	5,2 0.205	20,0 0.787	66,0 2.598	30,0 1.181	36,0 1.417	28,0 1.102	6,0 0.236	140°	Pokrycie DLC	IT8-9
SD203A-5.5-20-6R1-N	02691558	5,5 0.217	20,0 0.787	66,0 2.598	30,0 1.181	36,0 1.417	28,0 1.102	6,0 0.236	140°	Pokrycie DLC	IT8-9
SD203A-6.0-21-6R1-N	02691559	6,0 0.236	21,0 0.827	66,0 2.598	30,0 1.181	36,0 1.417	28,0 1.102	6,0 0.236	140°	Pokrycie DLC	IT8-9
SD203A-02500-091-0315R1-N	02691560	6,35 0.250	23,0 0.906	79,0 3.110	43,0 1.693	36,0 1.417	34,0 1.339	8,0 0.315	140°	Pokrycie DLC	IT8-9
SD203A-6.5-23-8R1-N	02691562	6,5 0.256	23,0 0.906	79,0 3.110	43,0 1.693	36,0 1.417	34,0 1.339	8,0 0.315	140°	Pokrycie DLC	IT8-9
SD203A-02656-098-0315R1-N	02691564	6,746 0.266	25,0 0.984	79,0 3.110	43,0 1.693	36,0 1.417	34,0 1.339	8,0 0.315	140°	Pokrycie DLC	IT8-9
SD203A-6.8-25-8R1-N	02691565	6,8 0.268	25,0 0.984	79,0 3.110	43,0 1.693	36,0 1.417	34,0 1.339	8,0 0.315	140°	Pokrycie DLC	IT8-9
SD203A-7.0-25-8R1-N	02643590	7,0 0.276	25,0 0.984	79,0 3.110	43,0 1.693	36,0 1.417	34,0 1.339	8,0 0.315	140°	Pokrycie DLC	IT8-9
SD203A-7.1-25-8R1-N	02691567	7,1 0.280	25,0 0.984	79,0 3.110	43,0 1.693	36,0 1.417	34,0 1.339	8,0 0.315	140°	Pokrycie DLC	IT8-9
SD203A-02813-098-0315R1-N	02691568	7,145 0.281	25,0 0.984	79,0 3.110	43,0 1.693	36,0 1.417	41,0 1.614	8,0 0.315	140°	Pokrycie DLC	IT8-9
SD203A-7.5-25-8R1-N	02691569	7,5 0.295	25,0 0.984	79,0 3.110	43,0 1.693	36,0 1.417	41,0 1.614	8,0 0.315	140°	Pokrycie DLC	IT8-9
SD203A-03125-106-0315R1-N	02691570	7,938 0.313	27,0 1.063	79,0 3.110	43,0 1.693	36,0 1.417	41,0 1.614	8,0 0.315	140°	Pokrycie DLC	IT8-9
SD203A-8.0-27-8R1-N	02691571	8,0 0.315	27,0 1.063	79,0 3.110	43,0 1.693	36,0 1.417	41,0 1.614	8,0 0.315	140°	Pokrycie DLC	IT8-9

Oznaczenie	Numer produktu	DC	LU	OAL	LFS	LS	LCF	DMM	Kąt wierzchołkowy	Pokrycie	Tolerancja otworu
		mm Cal.	mm Cal.	mm Cal.	mm Cal.	mm Cal.	mm Cal.	mm Cal.			
SD203A-8.5-27-10R1-N	02643592	8,5 0.335	27,0 1.063	89,0 3.504	49,0 1.929	40,0 1.575	47,0 1.850	10,0 0.394	140°	Pokrycie DLC	IT8-9
SD203A-9.0-29-10R1-N	02691574	9,0 0.354	29,0 1.142	89,0 3.504	49,0 1.929	40,0 1.575	47,0 1.850	10,0 0.394	140°	Pokrycie DLC	IT8-9
SD203A-9.5-29-10R1-N	02691575	9,5 0.374	29,0 1.142	89,0 3.504	49,0 1.929	40,0 1.575	47,0 1.850	10,0 0.394	140°	Pokrycie DLC	IT8-9
SD203A-03750-122-0394R1-N	02691576	9,525 0.375	31,0 1.220	89,0 3.504	49,0 1.929	40,0 1.575	47,0 1.850	10,0 0.394	140°	Pokrycie DLC	IT8-9
SD203A-10.0-31-10R1-N	02691577	10,0 0.394	31,0 1.220	89,0 3.504	49,0 1.929	40,0 1.575	47,0 1.850	10,0 0.394	140°	Pokrycie DLC	IT8-9
SD203A-10.2-31-12R1-N	02691578	10,2 0.402	31,0 1.220	102,0 4.016	57,0 2.244	45,0 1.772	55,0 2.165	12,0 0.472	140°	Pokrycie DLC	IT8-9
SD203A-04063-122-0472R1-N	02691579	10,32 0.406	31,0 1.220	102,0 4.016	57,0 2.244	45,0 1.772	55,0 2.165	12,0 0.472	140°	Pokrycie DLC	IT8-9
SD203A-10.5-31-12R1-N	02691580	10,5 0.413	31,0 1.220	102,0 4.016	57,0 2.244	45,0 1.772	55,0 2.165	12,0 0.472	140°	Pokrycie DLC	IT8-9
SD203A-11.0-33-12R1-N	02691582	11,0 0.433	33,0 1.299	102,0 4.016	57,0 2.244	45,0 1.772	55,0 2.165	12,0 0.472	140°	Pokrycie DLC	IT8-9
SD203A-04375-130-0472R1-N	02691585	11,113 0.438	33,0 1.299	102,0 4.016	57,0 2.244	45,0 1.772	55,0 2.165	12,0 0.472	140°	Pokrycie DLC	IT8-9
SD203A-11.5-33-12R1-N	02691588	11,5 0.453	33,0 1.299	102,0 4.016	57,0 2.244	45,0 1.772	55,0 2.165	12,0 0.472	140°	Pokrycie DLC	IT8-9
SD203A-12.0-36-12R1-N	02691589	12,0 0.472	36,0 1.417	102,0 4.016	57,0 2.244	45,0 1.772	55,0 2.165	12,0 0.472	140°	Pokrycie DLC	IT8-9
SD203A-12.5-36-14R1-N	02691591	12,5 0.492	36,0 1.417	107,0 4.213	62,0 2.441	45,0 1.772	60,0 2.362	14,0 0.551	140°	Pokrycie DLC	IT8-9
SD203A-05000-142-0551R1-N	02691592	12,7 0.500	36,0 1.417	107,0 4.213	62,0 2.441	45,0 1.772	60,0 2.362	14,0 0.551	140°	Pokrycie DLC	IT8-9
SD203A-13.0-36-14R1-N	02691594	13,0 0.512	36,0 1.417	107,0 4.213	62,0 2.441	45,0 1.772	60,0 2.362	14,0 0.551	140°	Pokrycie DLC	IT8-9
SD203A-05312-146-0551R1-N	02691596	13,492 0.531	37,0 1.457	107,0 4.213	62,0 2.441	45,0 1.772	60,0 2.362	14,0 0.551	140°	Pokrycie DLC	IT8-9
SD203A-13.5-37-14R1-N	02691597	13,5 0.531	37,0 1.457	107,0 4.213	62,0 2.441	45,0 1.772	60,0 2.362	14,0 0.551	140°	Pokrycie DLC	IT8-9
SD203A-14.0-37-14R1-N	02691598	14,0 0.551	37,0 1.457	107,0 4.213	62,0 2.441	45,0 1.772	60,0 2.362	14,0 0.551	140°	Pokrycie DLC	IT8-9

Wstęp

Wiercenie

Rozwiercanie

Wytaczanie

Załącznik



Wiercenie kompozytów

Seco oferuje dwa różne rozwiązania do wiercenia kompozytów: wiertła z powłoką diamentową i wiertła z ostrzem z diamentu polikrystalicznego (PCD). Narzędzia te charakteryzują się geometriami zoptymalizowanymi pod kątem zwykłych kompozytów lub pakietów.

- Geometria C1 i CX1 zoptymalizowana do zastosowań w materiałach CFRP
- Geometria C2 służy do wiercenia kompozytów zawierających warstwy aluminium
- CX1 to wiertła z polikrystalicznym diamentem (PCD), które oferują zwiększoną wydajność i długą trwałość narzędzia w porównaniu z konwencjonalnymi wiertłami podczas obróbki materiałów kompozytowych
- Zarówno C1, jak i C2 są wiertłami węglowymi z pokryciem diamentowym Dura, które zapewnia bardzo dobrą wytrzymałość i odporność na ścieranie

Obróbka kompozytów

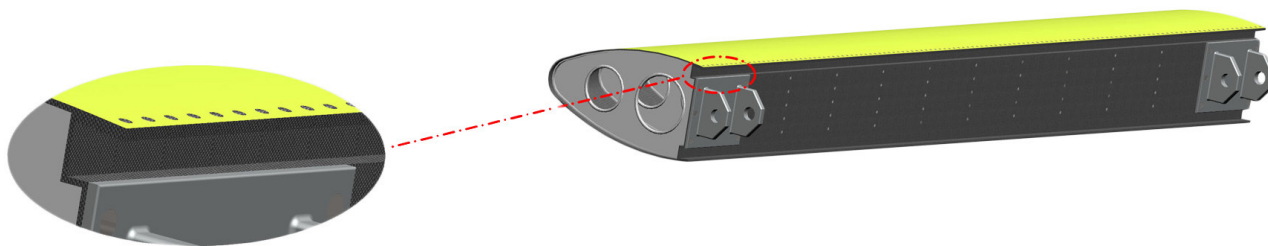

Gdy jakość otworu jest najważniejsza

Skupiono się głównie na problemie rozwarstwiania/odłupywania materiału: konstrukcja narzędzia, optymalna do kompozytów, a szczególnie do materiałów warstwowych. W obu przypadkach szczególnie skupiono się na uzyskaniu dobrych wyników na wejściu i wyjściu z materiału. (W materiałach warstwowych zwykle wyjście jest Al lub Ti).

- Brak efektu podnoszenia materiału (wejście)
- Brak efektu wypychania materiału (wyjście)

Pokrycie diamentowe Dura zapewnia dobrą tolerancję wymiarową przez długi okres użytkowania.



Przykład zastosowania

Zwykły CFRP/GFRP
(wyjście w materiale kompozytowym)



Geometria C1
Geometria CX1



Materiał wielowarstwowy
(wyjście Al/Ti)



Geometria C2



Rozwiązywanie problemów — Wyjście z otworu

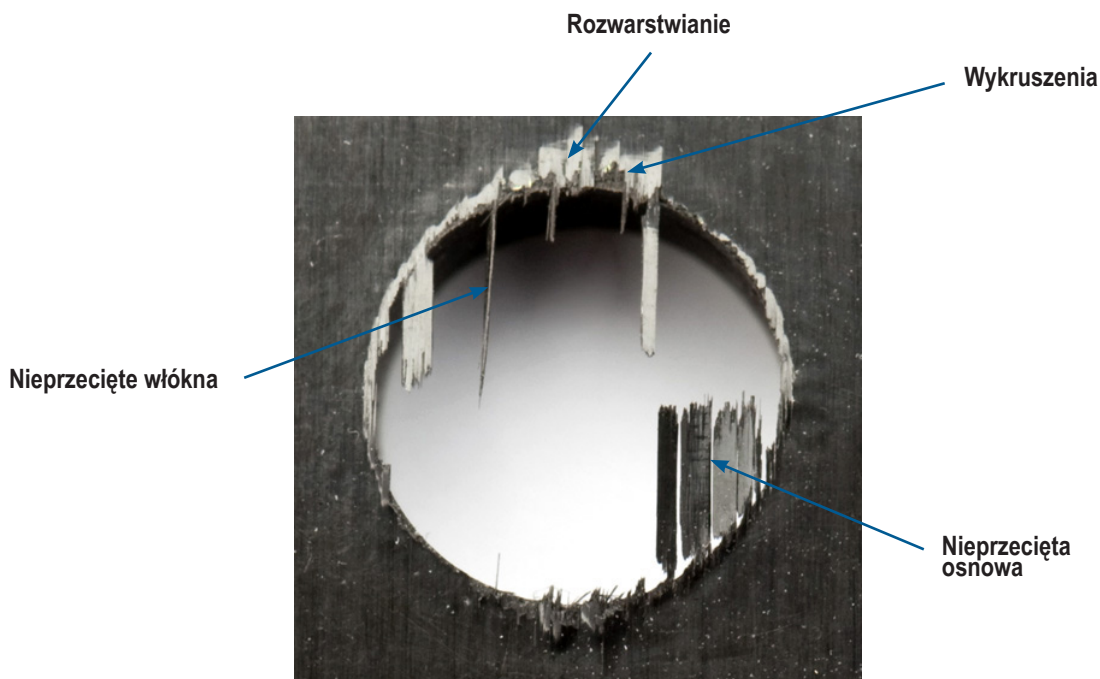

Problem:	Rozwarstwianie (wrywanie / wypychanie)	Wykruszenia	Nieprzecięte włókna	Nieprzecięta osnowa
Rozwiązanie:	Rozwarstwianie <ul style="list-style-type: none"> Stosować narzędzie o ujemnej geometrii Zmniejszyć posuw/obrót Wrywanie <ul style="list-style-type: none"> Zmniejszyć posuw/obrót 	<ul style="list-style-type: none"> Zastosować narzędzie o bardziej dodatniej geometrii Zredukować posuw/obr 	<ul style="list-style-type: none"> Stosować narzędzie o ostrzejszej geometrii Zredukować posuw/obr. 	<ul style="list-style-type: none"> Stosować narzędzie o ostrzejszej geometrii Zmniejszyć posuw/obrót Zmniejszyć prędkość skrawania
Problem:	Stopiona osnowa (zbyt dużo ciepła)	Mała trwałość ostrza		
Rozwiązanie:	<ul style="list-style-type: none"> Zmniejszyć prędkość skrawania 	<ul style="list-style-type: none"> Zmniejszyć prędkość skrawania 		

SD205A-C1

Głębokość wiercenia ~ 5 x D – Metryczne/Calowe

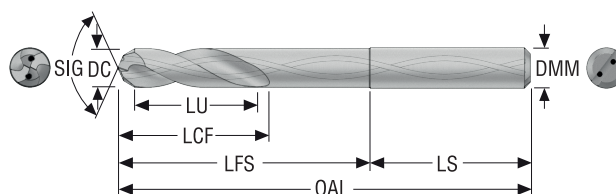

- Chwył cylindryczny DIN 6537A
- Chłodzenie wewnętrzne
- Parametry skrawania, patrz strona (strony) 163

Oznaczenie	Numer produktu	Zakładana tolerancja otworu		DC	LU	OAL	LFS	LS	LCF	DMM	Kąt wierzchołkowy	Pokrycie
		mm	Cal.	mm Cal.	mm Cal.	mm Cal.	mm Cal.	mm Cal.	mm Cal.	mm Cal.		
SD205A-6.0-31-6R1-C1	02740089	5,975/6,025	0.2352/0.2372	6,0 0.236	31,0 1.220	82,0 3.228	46,0 1.811	36,0 1.417	44,0 1.732	6,0 0.236	60°/130°	Pokrycie Dura
SD205A-9.55-46-10R1-C1	02740092	9,525/9,576	0.3750/0.3770	9,55 0.376	46,0 1.811	103,0 4.055	63,0 2.480	40,0 1.575	61,0 2.402	10,0 0.394	60°/130°	Pokrycie Dura

Wstęp

Wiercenie

Rozwiercanie

Wytaczanie

Załącznik

SD205A-C2

Głębokość wiercenia ~ 5 x D – Metryczne/Calowe

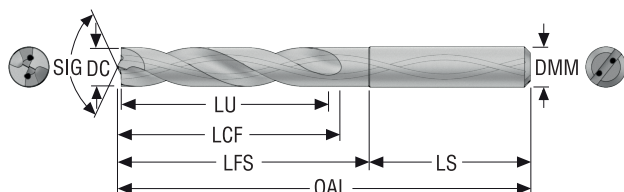

- Chwyt cylindryczny DIN 6537A
- Chłodzenie wewnętrzne
- Parametry skrawania, patrz strona (strony) 163

Oznaczenie	Numer produktu	Zakładana tolerancja otworu		DC	LU	OAL	LFS	LS	LCF	DMM	Kąt wierzchołkowy	Pokrycie
		mm	Cal.									
SD205A-6.0-32-6R1-C2	02740099	5,975/6,025	0.2352/0.2372	6,0 0.236	32,0 1.260	82,0 3.228	46,0 1.811	36,0 1.417	44,0 1.732	6,0 0.236	140°/180°	Pokrycie Dura
SD205A-9.55-48-10R1-C2	02740103	9,525/9,576	0.3750/0.3770	9,55 0.376	48,0 1.890	103,0 4.055	63,0 2.480	40,0 1.575	61,0 2.402	10,0 0.394	140°/180°	Pokrycie Dura

SD203-CX1

Głębokość wiercenia ~ 3 x D – Metryczne/Calowe

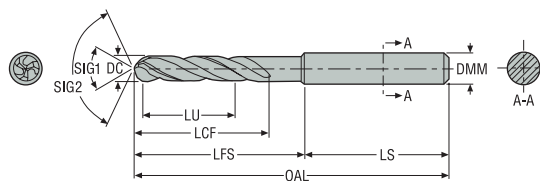

- Chwył cylindryczny DIN 6537A
- Krawędzie skrawające PCD
- Parametry skrawania, patrz strona (strony) 163

Oznaczenie	Numer produktu	Zakładana tolerancja otworu		DC	LU	OAL	LFS	LS	LCF	DMM	Kąt wierzchołkowy
		mm	Cal.								
SD203-3.26-14-6R1-CX1	02827923	3,235/3,285	0.1273/0.1293	3,26 0.128	14,0 0.551	62,0 2.441	26,0 1.024	36,0 1.417	21,0 0.827	6,0 0.236	60°/130°
SD203-4.17-17-6R1-CX1	02827924	4,142/4,192	0.1630/0.1650	4,17 0.164	17,0 0.669	66,0 2.598	30,0 1.181	36,0 1.417	25,0 0.984	6,0 0.236	60°/130°
SD203-4.83-20-6R1-CX1	02827925	4,805/4,855	0.1891/0.1911	4,83 0.190	20,0 0.787	66,0 2.598	30,0 1.181	36,0 1.417	28,0 1.102	6,0 0.236	60°/130°
SD203-6.06-21-6R1-CX1	02827926	6,035/6,085	0.2375/0.2395	6,06 0.239	21,0 0.827	66,0 2.598	30,0 1.181	36,0 1.417	28,0 1.102	6,0 0.236	60°/130°
SD203-6.36-23-8R1-CX1	02827927	6,33/6,38	0.2492/0.2511	6,36 0.250	23,0 0.906	79,0 3.110	43,0 1.693	36,0 1.417	34,0 1.339	8,0 0.315	60°/130°
SD203-7.94-27-8R1-CX1	02827928	7,913/7,963	0.3115/0.3135	7,94 0.313	27,0 1.063	79,0 3.110	43,0 1.693	36,0 1.417	41,0 1.614	8,0 0.315	60°/130°
SD203-9.53-31-10R1-CX1	02827929	9,504/9,554	0.3741/0.3761	9,53 0.375	31,0 1.220	89,0 3.504	49,0 1.929	40,0 1.575	47,0 1.850	10,0 0.394	60°/130°

Wstęp

Wiercenie

Rozwiercanie

Wyłaczanie

Załącznik



Mikrowiertła

Firma Seco asortyment mikrowiertel, w skład którego wchodzi serie mikrowiertel SD22 i SD26 z węgliku spiekanego.

- Znaczny wzrost wydajności w porównaniu z tradycyjnymi wiertłami HSS
- Możliwość stosowania w branży motoryzacyjnej i medycznej, a także do produkcji małych części w przemyśle inżynierii ogólnej

SD22

Głębokość wiercenia ~ 2 x D (z pilotem) – Metryczne/Calowe

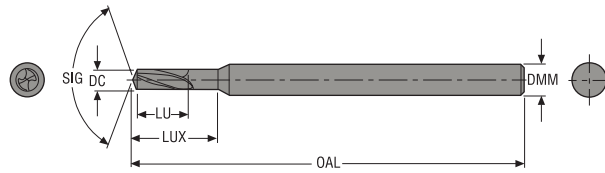

- Chwyt cylindryczny
- Zewnętrzne kanały doprowadzające chłodziwo
- Parametry skrawania, patrz strona (strony) 164-168

Oznaczenie	Numer produktu	DC	LU	OAL	LUX	DMM	Kąt wierzchołkowy	Pokrycie
		mm Cal.	mm Cal.	mm Cal.	mm Cal.	mm Cal.		
SD22-0.10-0.20-3R1	02731574	0,1 0.004	0,2 0.008	38,0 1.496	0,55 0.022	3,0 0.118	130°	Niepokr.
SD22-0.11-0.22-3R1	02730362	0,11 0.004	0,22 0.009	38,0 1.496	0,55 0.022	3,0 0.118	130°	Niepokr.
SD22-0.12-0.24-3R1	02730460	0,12 0.005	0,24 0.009	38,0 1.496	0,55 0.022	3,0 0.118	130°	Niepokr.
SD22-0.13-0.26-3R1	02730461	0,13 0.005	0,26 0.010	38,0 1.496	0,6 0.024	3,0 0.118	130°	Niepokr.
SD22-0.14-0.28-3R1	02730462	0,14 0.006	0,28 0.011	38,0 1.496	0,6 0.024	3,0 0.118	130°	Niepokr.
SD22-0.15-0.30-3R1	02731575	0,15 0.006	0,3 0.012	38,0 1.496	0,6 0.024	3,0 0.118	130°	Niepokr.
SD22-0.16-0.32-3R1	02730464	0,16 0.006	0,32 0.013	38,0 1.496	0,6 0.024	3,0 0.118	130°	Niepokr.
SD22-0.17-0.34-3R1	02730465	0,17 0.007	0,34 0.013	38,0 1.496	0,7 0.028	3,0 0.118	130°	Niepokr.
SD22-0.18-0.36-3R1	02730466	0,18 0.007	0,36 0.014	38,0 1.496	0,7 0.028	3,0 0.118	130°	Niepokr.
SD22-0.19-0.38-3R1	02730467	0,19 0.007	0,38 0.015	38,0 1.496	0,7 0.028	3,0 0.118	130°	Niepokr.
SD22-0.20-0.40-3R1	02731576	0,2 0.008	0,4 0.016	38,0 1.496	0,75 0.030	3,0 0.118	130°	Niepokr.
SD22-0.21-0.42-3R1	02730468	0,21 0.008	0,42 0.017	38,0 1.496	0,75 0.030	3,0 0.118	130°	Niepokr.
SD22-0.22-0.44-3R1	02730469	0,22 0.009	0,44 0.017	38,0 1.496	0,8 0.031	3,0 0.118	130°	Niepokr.
SD22-0.23-0.46-3R1	02730470	0,23 0.009	0,46 0.018	38,0 1.496	0,8 0.031	3,0 0.118	130°	Niepokr.
SD22-0.24-0.48-3R1	02730471	0,24 0.009	0,48 0.019	38,0 1.496	0,8 0.031	3,0 0.118	130°	Niepokr.
SD22-0.25-0.50-3R1	02731577	0,25 0.010	0,5 0.020	38,0 1.496	0,9 0.035	3,0 0.118	130°	Niepokr.
SD22-0.26-0.52-3R1	02730472	0,26 0.010	0,52 0.020	38,0 1.496	0,9 0.035	3,0 0.118	130°	Niepokr.
SD22-0.27-0.54-3R1	02730473	0,27 0.011	0,54 0.021	38,0 1.496	0,9 0.035	3,0 0.118	130°	Niepokr.
SD22-0.28-0.56-3R1	02730474	0,28 0.011	0,56 0.022	38,0 1.496	1,0 0.039	3,0 0.118	130°	Niepokr.
SD22-0.29-0.58-3R1	02730475	0,29 0.011	0,58 0.023	38,0 1.496	1,0 0.039	3,0 0.118	130°	Niepokr.
SD22-0.30-0.60-3R1	02731579	0,3 0.012	0,6 0.024	38,0 1.496	1,2 0.047	3,0 0.118	130°	Niepokr.
SD22-0.31-0.62-3R1	02730476	0,31 0.012	0,62 0.024	38,0 1.496	1,2 0.047	3,0 0.118	130°	Niepokr.

Oznaczenie	Numer produktu	DC	LU	OAL	LUX	DMM	Kąt wierzchołkowy	Pokrycie
		mm Cal.	mm Cal.	mm Cal.	mm Cal.	mm Cal.	°	
SD22-0.32-0.64-3R1	02730477	0,32 0.013	0,64 0.025	38,0 1.496	1,2 0.047	3,0 0.118	130°	Niepokr.
SD22-0.33-0.66-3R1	02730478	0,33 0.013	0,66 0.026	38,0 1.496	1,2 0.047	3,0 0.118	130°	Niepokr.
SD22-0.34-0.68-3R1	02730479	0,34 0.013	0,68 0.027	38,0 1.496	1,35 0.053	3,0 0.118	130°	Niepokr.
SD22-0.35-0.70-3R1	02731580	0,35 0.014	0,7 0.028	38,0 1.496	1,35 0.053	3,0 0.118	130°	Niepokr.
SD22-0.36-0.72-3R1	02730480	0,36 0.014	0,72 0.028	38,0 1.496	1,35 0.053	3,0 0.118	130°	Niepokr.
SD22-0.37-0.74-3R1	02730481	0,37 0.015	0,74 0.029	38,0 1.496	1,35 0.053	3,0 0.118	130°	Niepokr.
SD22-0.38-0.76-3R1	02730482	0,38 0.015	0,76 0.030	38,0 1.496	1,5 0.059	3,0 0.118	130°	Niepokr.
SD22-0.39-0.78-3R1	02730483	0,39 0.015	0,78 0.031	38,0 1.496	1,5 0.059	3,0 0.118	130°	Niepokr.
SD22-0.40-0.80-3R1	02731581	0,4 0.016	0,8 0.031	38,0 1.496	1,6 0.063	3,0 0.118	130°	Niepokr.
SD22-0.41-0.82-3R1	02730484	0,41 0.016	0,82 0.032	38,0 1.496	1,6 0.063	3,0 0.118	130°	Niepokr.
SD22-0.42-0.84-3R1	02730485	0,42 0.017	0,84 0.033	38,0 1.496	1,6 0.063	3,0 0.118	130°	Niepokr.
SD22-0.43-0.86-3R1	02730486	0,43 0.017	0,86 0.034	38,0 1.496	1,6 0.063	3,0 0.118	130°	Niepokr.
SD22-0.44-0.88-3R1	02730487	0,44 0.017	0,88 0.035	38,0 1.496	1,6 0.063	3,0 0.118	130°	Niepokr.
SD22-0.45-0.90-3R1	02731582	0,45 0.018	0,9 0.035	38,0 1.496	1,6 0.063	3,0 0.118	130°	Niepokr.
SD22-0.46-0.92-3R1	02730488	0,46 0.018	0,92 0.036	38,0 1.496	1,7 0.067	3,0 0.118	130°	Niepokr.
SD22-0.47-0.94-3R1	02730489	0,47 0.019	0,94 0.037	38,0 1.496	1,7 0.067	3,0 0.118	130°	Niepokr.
SD22-0.48-0.96-3R1	02730490	0,48 0.019	0,96 0.038	38,0 1.496	1,7 0.067	3,0 0.118	130°	Niepokr.
SD22-0.49-0.98-3R1	02730491	0,49 0.019	0,98 0.039	38,0 1.496	1,7 0.067	3,0 0.118	130°	Niepokr.
SD22-0.50-1.00-3R1	02731584	0,5 0.020	1,0 0.039	38,0 1.496	1,7 0.067	3,0 0.118	130°	Niepokr.
SD22-0.51-1.02-3R1	02730492	0,51 0.020	1,02 0.040	38,0 1.496	1,8 0.071	3,0 0.118	130°	Niepokr.
SD22-0.52-1.04-3R1	02730493	0,52 0.020	1,04 0.041	38,0 1.496	1,8 0.071	3,0 0.118	130°	Niepokr.
SD22-0.53-1.06-3R1	02730494	0,53 0.021	1,06 0.042	38,0 1.496	1,8 0.071	3,0 0.118	130°	Niepokr.
SD22-0.54-1.08-3R1	02730495	0,54 0.021	1,08 0.043	38,0 1.496	1,8 0.071	3,0 0.118	130°	Niepokr.
SD22-0.55-1.10-3R1	02731585	0,55 0.022	1,1 0.043	38,0 1.496	1,8 0.071	3,0 0.118	130°	Niepokr.
SD22-0.56-1.12-3R1	02730496	0,56 0.022	1,12 0.044	38,0 1.496	1,9 0.075	3,0 0.118	130°	Niepokr.
SD22-0.57-1.14-3R1	02730497	0,57 0.022	1,14 0.045	38,0 1.496	1,9 0.075	3,0 0.118	130°	Niepokr.
SD22-0.58-1.16-3R1	02730498	0,58 0.023	1,16 0.046	38,0 1.496	1,9 0.075	3,0 0.118	130°	Niepokr.
SD22-0.59-1.18-3R1	02730499	0,59 0.023	1,18 0.046	38,0 1.496	1,9 0.075	3,0 0.118	130°	Niepokr.
SD22-0.60-1.20-3R1	02731586	0,6 0.024	1,2 0.047	38,0 1.496	1,9 0.075	3,0 0.118	130°	Niepokr.
SD22-0.61-1.22-3R1	02730500	0,61 0.024	1,22 0.048	38,0 1.496	2,0 0.079	3,0 0.118	130°	Niepokr.
SD22-0.62-1.24-3R1	02730501	0,62 0.024	1,24 0.049	38,0 1.496	2,0 0.079	3,0 0.118	130°	Niepokr.

Oznaczenie	Numer produktu	DC	LU	OAL	LUX	DMM	Kąt wierzchołkowy	Pokrycie
		mm Cal.	mm Cal.	mm Cal.	mm Cal.	mm Cal.		
SD22-0.63-1.26-3R1	02730502	0,63 0.025	1,26 0.050	38,0 1.496	2,0 0.079	3,0 0.118	130°	Niepokr.
SD22-0.64-1.28-3R1	02730503	0,64 0.025	1,28 0.050	38,0 1.496	2,0 0.079	3,0 0.118	130°	Niepokr.
SD22-0.65-1.30-3R1	02731587	0,65 0.026	1,3 0.051	38,0 1.496	2,0 0.079	3,0 0.118	130°	Niepokr.
SD22-0.66-1.32-3R1	02730504	0,66 0.026	1,32 0.052	38,0 1.496	2,1 0.083	3,0 0.118	130°	Niepokr.
SD22-0.67-1.34-3R1	02730505	0,67 0.026	1,34 0.053	38,0 1.496	2,1 0.083	3,0 0.118	130°	Niepokr.
SD22-0.68-1.36-3R1	02730506	0,68 0.027	1,36 0.054	38,0 1.496	2,1 0.083	3,0 0.118	130°	Niepokr.
SD22-0.69-1.38-3R1	02730507	0,69 0.027	1,38 0.054	38,0 1.496	2,1 0.083	3,0 0.118	130°	Niepokr.
SD22-0.70-1.40-3R1	02731589	0,7 0.028	1,4 0.055	38,0 1.496	2,1 0.083	3,0 0.118	130°	Niepokr.
SD22-0.71-1.42-3R1	02730508	0,71 0.028	1,42 0.056	38,0 1.496	2,2 0.087	3,0 0.118	130°	Niepokr.
SD22-0.72-1.44-3R1	02730509	0,72 0.028	1,44 0.057	38,0 1.496	2,2 0.087	3,0 0.118	130°	Niepokr.
SD22-0.73-1.46-3R1	02730510	0,73 0.029	1,46 0.057	38,0 1.496	2,2 0.087	3,0 0.118	130°	Niepokr.
SD22-0.74-1.48-3R1	02730511	0,74 0.029	1,48 0.058	38,0 1.496	2,2 0.087	3,0 0.118	130°	Niepokr.
SD22-0.75-1.50-3R1	02731590	0,75 0.030	1,5 0.059	38,0 1.496	2,2 0.087	3,0 0.118	130°	Niepokr.
SD22-0.76-1.52-3R1	02730512	0,76 0.030	1,52 0.060	38,0 1.496	2,3 0.091	3,0 0.118	130°	Niepokr.
SD22-0.77-1.54-3R1	02730513	0,77 0.030	1,54 0.061	38,0 1.496	2,3 0.091	3,0 0.118	130°	Niepokr.
SD22-0.78-1.56-3R1	02730514	0,78 0.031	1,56 0.061	38,0 1.496	2,3 0.091	3,0 0.118	130°	Niepokr.
SD22-0.79-1.58-3R1	02730515	0,79 0.031	1,58 0.062	38,0 1.496	2,3 0.091	3,0 0.118	130°	Niepokr.
SD22-0.80-1.60-3R1	02731592	0,8 0.031	1,6 0.063	38,0 1.496	2,3 0.091	3,0 0.118	130°	Niepokr.
SD22-0.81-1.62-3R1	02730516	0,81 0.032	1,62 0.064	38,0 1.496	2,4 0.094	3,0 0.118	130°	Niepokr.
SD22-0.82-1.64-3R1	02730517	0,82 0.032	1,64 0.065	38,0 1.496	2,4 0.094	3,0 0.118	130°	Niepokr.
SD22-0.83-1.66-3R1	02730518	0,83 0.033	1,66 0.065	38,0 1.496	2,4 0.094	3,0 0.118	130°	Niepokr.
SD22-0.84-1.68-3R1	02730519	0,84 0.033	1,68 0.066	38,0 1.496	2,4 0.094	3,0 0.118	130°	Niepokr.
SD22-0.85-1.70-3R1	02731593	0,85 0.033	1,7 0.067	38,0 1.496	2,4 0.094	3,0 0.118	130°	Niepokr.
SD22-0.86-1.72-3R1	02730520	0,86 0.034	1,72 0.068	38,0 1.496	2,5 0.098	3,0 0.118	130°	Niepokr.
SD22-0.87-1.74-3R1	02730521	0,87 0.034	1,74 0.069	38,0 1.496	2,5 0.098	3,0 0.118	130°	Niepokr.
SD22-0.88-1.76-3R1	02730522	0,88 0.035	1,76 0.069	38,0 1.496	2,5 0.098	3,0 0.118	130°	Niepokr.
SD22-0.89-1.78-3R1	02730523	0,89 0.035	1,78 0.070	38,0 1.496	2,5 0.098	3,0 0.118	130°	Niepokr.
SD22-0.90-1.80-3R1	02731594	0,9 0.035	1,8 0.071	38,0 1.496	2,5 0.098	3,0 0.118	130°	Niepokr.
SD22-0.91-1.82-3R1	02730524	0,91 0.036	1,82 0.072	38,0 1.496	2,6 0.102	3,0 0.118	130°	Niepokr.
SD22-0.92-1.84-3R1	02730525	0,92 0.036	1,84 0.072	38,0 1.496	2,6 0.102	3,0 0.118	130°	Niepokr.
SD22-0.93-1.86-3R1	02730526	0,93 0.037	1,86 0.073	38,0 1.496	2,6 0.102	3,0 0.118	130°	Niepokr.

Wstęp

Wiercenie

Rozwiercanie

Wytaczanie

Załącznik

Oznaczenie	Numer produktu	DC	LU	OAL	LUX	DMM	Kąt wierzchołkowy	Pokrycie
		mm Cal.	mm Cal.	mm Cal.	mm Cal.	mm Cal.	°	
SD22-0.94-1.88-3R1	02730527	0,94 0.037	1,88 0.074	38,0 1.496	2,6 0.102	3,0 0.118	130°	Niepokr.
SD22-0.95-1.90-3R1	02731595	0,95 0.037	1,9 0.075	38,0 1.496	2,6 0.102	3,0 0.118	130°	Niepokr.
SD22-0.96-1.92-3R1	02730528	0,96 0.038	1,92 0.076	38,0 1.496	2,7 0.106	3,0 0.118	130°	Niepokr.
SD22-0.97-1.94-3R1	02730529	0,97 0.038	1,94 0.076	38,0 1.496	2,7 0.106	3,0 0.118	130°	Niepokr.
SD22-0.98-1.96-3R1	02730530	0,98 0.039	1,96 0.077	38,0 1.496	2,7 0.106	3,0 0.118	130°	Niepokr.
SD22-0.99-1.98-3R1	02730531	0,99 0.039	1,98 0.078	38,0 1.496	2,7 0.106	3,0 0.118	130°	Niepokr.
SD22-1.00-2.00-3R1	02731596	1,0 0.039	2,0 0.079	38,0 1.496	2,7 0.106	3,0 0.118	130°	Niepokr.
SD22-1.01-2.02-3R1	02730532	1,01 0.040	2,02 0.080	38,0 1.496	3,5 0.138	3,0 0.118	130°	Niepokr.
SD22-1.02-2.04-3R1	02730533	1,02 0.040	2,04 0.080	38,0 1.496	3,5 0.138	3,0 0.118	130°	Niepokr.
SD22-1.03-2.06-3R1	02730534	1,03 0.041	2,06 0.081	38,0 1.496	3,5 0.138	3,0 0.118	130°	Niepokr.
SD22-1.04-2.08-3R1	02730535	1,04 0.041	2,08 0.082	38,0 1.496	3,5 0.138	3,0 0.118	130°	Niepokr.
SD22-1.05-2.10-3R1	02730536	1,05 0.041	2,1 0.083	38,0 1.496	3,5 0.138	3,0 0.118	130°	Niepokr.
SD22-1.06-2.12-3R1	02730537	1,06 0.042	2,12 0.083	38,0 1.496	3,6 0.142	3,0 0.118	130°	Niepokr.
SD22-1.07-2.14-3R1	02730538	1,07 0.042	2,14 0.084	38,0 1.496	3,6 0.142	3,0 0.118	130°	Niepokr.
SD22-1.08-2.16-3R1	02730539	1,08 0.043	2,16 0.085	38,0 1.496	3,6 0.142	3,0 0.118	130°	Niepokr.
SD22-1.09-2.18-3R1	02730540	1,09 0.043	2,18 0.086	38,0 1.496	3,6 0.142	3,0 0.118	130°	Niepokr.
SD22-1.10-2.20-3R1	02731598	1,1 0.043	2,2 0.087	38,0 1.496	3,6 0.142	3,0 0.118	130°	Niepokr.
SD22-1.11-2.22-3R1	02730541	1,11 0.044	2,22 0.087	38,0 1.496	3,7 0.146	3,0 0.118	130°	Niepokr.
SD22-1.12-2.24-3R1	02730542	1,12 0.044	2,24 0.088	38,0 1.496	3,7 0.146	3,0 0.118	130°	Niepokr.
SD22-1.13-2.26-3R1	02730543	1,13 0.044	2,26 0.089	38,0 1.496	3,7 0.146	3,0 0.118	130°	Niepokr.
SD22-1.14-2.28-3R1	02730544	1,14 0.045	2,28 0.090	38,0 1.496	3,7 0.146	3,0 0.118	130°	Niepokr.
SD22-1.15-2.30-3R1	02730545	1,15 0.045	2,3 0.091	38,0 1.496	3,7 0.146	3,0 0.118	130°	Niepokr.
SD22-1.16-2.32-3R1	02730546	1,16 0.046	2,32 0.091	38,0 1.496	3,8 0.150	3,0 0.118	130°	Niepokr.
SD22-1.17-2.34-3R1	02730547	1,17 0.046	2,34 0.092	38,0 1.496	3,8 0.150	3,0 0.118	130°	Niepokr.
SD22-1.18-2.36-3R1	02730548	1,18 0.046	2,36 0.093	38,0 1.496	3,8 0.150	3,0 0.118	130°	Niepokr.
SD22-1.19-2.38-3R1	02730549	1,19 0.047	2,38 0.094	38,0 1.496	3,8 0.150	3,0 0.118	130°	Niepokr.
SD22-1.20-2.40-3R1	02731599	1,2 0.047	2,4 0.094	38,0 1.496	3,8 0.150	3,0 0.118	130°	Niepokr.
SD22-1.21-2.42-3R1	02730550	1,21 0.048	2,42 0.095	38,0 1.496	4,2 0.165	3,0 0.118	130°	Niepokr.
SD22-1.22-2.44-3R1	02730551	1,22 0.048	2,44 0.096	38,0 1.496	4,2 0.165	3,0 0.118	130°	Niepokr.
SD22-1.23-2.46-3R1	02730552	1,23 0.048	2,46 0.097	38,0 1.496	4,2 0.165	3,0 0.118	130°	Niepokr.
SD22-1.24-2.48-3R1	02730553	1,24 0.049	2,48 0.098	38,0 1.496	4,2 0.165	3,0 0.118	130°	Niepokr.

Oznaczenie	Numer produktu	DC	LU	OAL	LUX	DMM	Kąt wierzchołkowy	Pokrycie
		mm Cal.	mm Cal.	mm Cal.	mm Cal.	mm Cal.		
SD22-1.25-2.50-3R1	02730554	1,25 0.049	2,5 0.098	38,0 1.496	4,2 0.165	3,0 0.118	130°	Niepokr.
SD22-1.26-2.52-3R1	02730555	1,26 0.050	2,52 0.099	38,0 1.496	4,3 0.169	3,0 0.118	130°	Niepokr.
SD22-1.27-2.54-3R1	02730556	1,27 0.050	2,54 0.100	38,0 1.496	4,3 0.169	3,0 0.118	130°	Niepokr.
SD22-1.28-2.56-3R1	02730557	1,28 0.050	2,56 0.101	38,0 1.496	4,3 0.169	3,0 0.118	130°	Niepokr.
SD22-1.29-2.58-3R1	02730558	1,29 0.051	2,58 0.102	38,0 1.496	4,3 0.169	3,0 0.118	130°	Niepokr.
SD22-1.30-2.60-3R1	02731600	1,3 0.051	2,6 0.102	38,0 1.496	4,3 0.169	3,0 0.118	130°	Niepokr.
SD22-1.31-2.62-3R1	02730559	1,31 0.052	2,62 0.103	38,0 1.496	4,4 0.173	3,0 0.118	130°	Niepokr.
SD22-1.32-2.64-3R1	02730560	1,32 0.052	2,64 0.104	38,0 1.496	4,4 0.173	3,0 0.118	130°	Niepokr.
SD22-1.33-2.66-3R1	02730561	1,33 0.052	2,66 0.105	38,0 1.496	4,4 0.173	3,0 0.118	130°	Niepokr.
SD22-1.34-2.68-3R1	02730562	1,34 0.053	2,68 0.106	38,0 1.496	4,4 0.173	3,0 0.118	130°	Niepokr.
SD22-1.35-2.70-3R1	02730563	1,35 0.053	2,7 0.106	38,0 1.496	4,4 0.173	3,0 0.118	130°	Niepokr.
SD22-1.36-2.72-3R1	02730564	1,36 0.054	2,72 0.107	38,0 1.496	4,5 0.177	3,0 0.118	130°	Niepokr.
SD22-1.37-2.74-3R1	02730565	1,37 0.054	2,74 0.108	38,0 1.496	4,5 0.177	3,0 0.118	130°	Niepokr.
SD22-1.38-2.76-3R1	02730566	1,38 0.054	2,76 0.109	38,0 1.496	4,5 0.177	3,0 0.118	130°	Niepokr.
SD22-1.39-2.78-3R1	02730567	1,39 0.055	2,78 0.109	38,0 1.496	4,5 0.177	3,0 0.118	130°	Niepokr.
SD22-1.40-2.80-3R1	02731602	1,4 0.055	2,8 0.110	38,0 1.496	4,5 0.177	3,0 0.118	130°	Niepokr.
SD22-1.41-2.82-3R1	02730568	1,41 0.056	2,82 0.111	38,0 1.496	4,6 0.181	3,0 0.118	130°	Niepokr.
SD22-1.42-2.84-3R1	02730569	1,42 0.056	2,84 0.112	38,0 1.496	4,6 0.181	3,0 0.118	130°	Niepokr.
SD22-1.43-2.86-3R1	02730570	1,43 0.056	2,86 0.113	38,0 1.496	4,6 0.181	3,0 0.118	130°	Niepokr.
SD22-1.44-2.88-3R1	02730571	1,44 0.057	2,88 0.113	38,0 1.496	4,6 0.181	3,0 0.118	130°	Niepokr.
SD22-1.45-2.90-3R1	02730572	1,45 0.057	2,9 0.114	38,0 1.496	4,6 0.181	3,0 0.118	130°	Niepokr.
SD22-1.46-2.92-3R1	02730573	1,46 0.057	2,92 0.115	38,0 1.496	4,7 0.185	3,0 0.118	130°	Niepokr.
SD22-1.47-2.94-3R1	02730574	1,47 0.058	2,94 0.116	38,0 1.496	4,7 0.185	3,0 0.118	130°	Niepokr.
SD22-1.48-2.96-3R1	02730575	1,48 0.058	2,96 0.117	38,0 1.496	4,7 0.185	3,0 0.118	130°	Niepokr.
SD22-1.49-2.98-3R1	02730576	1,49 0.059	2,98 0.117	38,0 1.496	4,7 0.185	3,0 0.118	130°	Niepokr.
SD22-1.50-3.00-3R1	02731603	1,5 0.059	3,0 0.118	38,0 1.496	4,7 0.185	3,0 0.118	130°	Niepokr.
SD22-1.51-3.02-3R1	02730577	1,51 0.059	3,02 0.119	38,0 1.496	5,1 0.201	3,0 0.118	130°	Niepokr.
SD22-1.52-3.04-3R1	02730578	1,52 0.060	3,04 0.120	38,0 1.496	5,1 0.201	3,0 0.118	130°	Niepokr.
SD22-1.53-3.06-3R1	02730579	1,53 0.060	3,06 0.120	38,0 1.496	5,1 0.201	3,0 0.118	130°	Niepokr.
SD22-1.54-3.08-3R1	02730580	1,54 0.061	3,08 0.121	38,0 1.496	5,1 0.201	3,0 0.118	130°	Niepokr.
SD22-1.55-3.10-3R1	02730581	1,55 0.061	3,1 0.122	38,0 1.496	5,1 0.201	3,0 0.118	130°	Niepokr.

Oznaczenie	Numer produktu	DC	LU	OAL	LUX	DMM	Kąt wierzchołkowy	Pokrycie
		mm Cal.	mm Cal.	mm Cal.	mm Cal.	mm Cal.	°	
SD22-1.56-3.12-3R1	02730582	1,56 0.061	3,12 0.123	38,0 1.496	5,2 0.205	3,0 0.118	130°	Niepokr.
SD22-1.57-3.14-3R1	02730583	1,57 0.062	3,14 0.124	38,0 1.496	5,2 0.205	3,0 0.118	130°	Niepokr.
SD22-1.58-3.16-3R1	02730584	1,58 0.062	3,16 0.124	38,0 1.496	5,2 0.205	3,0 0.118	130°	Niepokr.
SD22-1.59-3.18-3R1	02730585	1,59 0.063	3,18 0.125	38,0 1.496	5,2 0.205	3,0 0.118	130°	Niepokr.
SD22-1.60-3.20-3R1	02731605	1,6 0.063	3,2 0.126	38,0 1.496	5,2 0.205	3,0 0.118	130°	Niepokr.
SD22-1.61-3.22-3R1	02730586	1,61 0.063	3,22 0.127	38,0 1.496	5,3 0.209	3,0 0.118	130°	Niepokr.
SD22-1.62-3.24-3R1	02730587	1,62 0.064	3,24 0.128	38,0 1.496	5,3 0.209	3,0 0.118	130°	Niepokr.
SD22-1.63-3.26-3R1	02730588	1,63 0.064	3,26 0.128	38,0 1.496	5,3 0.209	3,0 0.118	130°	Niepokr.
SD22-1.64-3.28-3R1	02730589	1,64 0.065	3,28 0.129	38,0 1.496	5,3 0.209	3,0 0.118	130°	Niepokr.
SD22-1.65-3.30-3R1	02730590	1,65 0.065	3,3 0.130	38,0 1.496	5,3 0.209	3,0 0.118	130°	Niepokr.
SD22-1.66-3.32-3R1	02730592	1,66 0.065	3,32 0.131	38,0 1.496	5,4 0.213	3,0 0.118	130°	Niepokr.
SD22-1.67-3.34-3R1	02730593	1,67 0.066	3,34 0.131	38,0 1.496	5,4 0.213	3,0 0.118	130°	Niepokr.
SD22-1.68-3.36-3R1	02730594	1,68 0.066	3,36 0.132	38,0 1.496	5,4 0.213	3,0 0.118	130°	Niepokr.
SD22-1.69-3.38-3R1	02730595	1,69 0.067	3,38 0.133	38,0 1.496	5,4 0.213	3,0 0.118	130°	Niepokr.
SD22-1.70-3.40-3R1	02731606	1,7 0.067	3,4 0.134	38,0 1.496	5,4 0.213	3,0 0.118	130°	Niepokr.
SD22-1.71-3.42-3R1	02730596	1,71 0.067	3,42 0.135	38,0 1.496	5,5 0.217	3,0 0.118	130°	Niepokr.
SD22-1.72-3.44-3R1	02730597	1,72 0.068	3,44 0.135	38,0 1.496	5,5 0.217	3,0 0.118	130°	Niepokr.
SD22-1.73-3.46-3R1	02730598	1,73 0.068	3,46 0.136	38,0 1.496	5,5 0.217	3,0 0.118	130°	Niepokr.
SD22-1.74-3.48-3R1	02730599	1,74 0.069	3,48 0.137	38,0 1.496	5,5 0.217	3,0 0.118	130°	Niepokr.
SD22-1.75-3.50-3R1	02730601	1,75 0.069	3,5 0.138	38,0 1.496	5,5 0.217	3,0 0.118	130°	Niepokr.
SD22-1.76-3.52-3R1	02730602	1,76 0.069	3,52 0.139	38,0 1.496	5,6 0.220	3,0 0.118	130°	Niepokr.
SD22-1.77-3.54-3R1	02730603	1,77 0.070	3,54 0.139	38,0 1.496	5,6 0.220	3,0 0.118	130°	Niepokr.
SD22-1.78-3.56-3R1	02730604	1,78 0.070	3,56 0.140	38,0 1.496	5,6 0.220	3,0 0.118	130°	Niepokr.
SD22-1.79-3.58-3R1	02730605	1,79 0.070	3,58 0.141	38,0 1.496	5,6 0.220	3,0 0.118	130°	Niepokr.
SD22-1.80-3.60-3R1	02731607	1,8 0.071	3,6 0.142	38,0 1.496	5,6 0.220	3,0 0.118	130°	Niepokr.
SD22-1.81-3.62-3R1	02730606	1,81 0.071	3,62 0.143	38,0 1.496	5,7 0.224	3,0 0.118	130°	Niepokr.
SD22-1.82-3.64-3R1	02730607	1,82 0.072	3,64 0.143	38,0 1.496	5,7 0.224	3,0 0.118	130°	Niepokr.
SD22-1.83-3.66-3R1	02730608	1,83 0.072	3,66 0.144	38,0 1.496	5,7 0.224	3,0 0.118	130°	Niepokr.
SD22-1.84-3.68-3R1	02730609	1,84 0.072	3,68 0.145	38,0 1.496	5,7 0.224	3,0 0.118	130°	Niepokr.
SD22-1.85-3.70-3R1	02730610	1,85 0.073	3,7 0.146	38,0 1.496	5,7 0.224	3,0 0.118	130°	Niepokr.
SD22-1.86-3.72-3R1	02730611	1,86 0.073	3,72 0.146	38,0 1.496	5,8 0.228	3,0 0.118	130°	Niepokr.

Oznaczenie	Numer produktu	DC	LU	OAL	LUX	DMM	Kąt wierzchołkowy	Pokrycie
		mm <i>Cal.</i>	mm <i>Cal.</i>	mm <i>Cal.</i>	mm <i>Cal.</i>	mm <i>Cal.</i>		
SD22-1.87-3.74-3R1	02730612	1,87 <i>0.074</i>	3,74 <i>0.147</i>	38,0 <i>1.496</i>	5,8 <i>0.228</i>	3,0 <i>0.118</i>	130°	Niepokr.
SD22-1.88-3.76-3R1	02730613	1,88 <i>0.074</i>	3,76 <i>0.148</i>	38,0 <i>1.496</i>	5,8 <i>0.228</i>	3,0 <i>0.118</i>	130°	Niepokr.
SD22-1.89-3.78-3R1	02730614	1,89 <i>0.074</i>	3,78 <i>0.149</i>	38,0 <i>1.496</i>	5,8 <i>0.228</i>	3,0 <i>0.118</i>	130°	Niepokr.
SD22-1.90-3.80-3R1	02731609	1,9 <i>0.075</i>	3,8 <i>0.150</i>	38,0 <i>1.496</i>	5,8 <i>0.228</i>	3,0 <i>0.118</i>	130°	Niepokr.
SD22-1.91-3.82-3R1	02730615	1,91 <i>0.075</i>	3,82 <i>0.150</i>	38,0 <i>1.496</i>	5,9 <i>0.232</i>	3,0 <i>0.118</i>	130°	Niepokr.
SD22-1.92-3.84-3R1	02730616	1,92 <i>0.076</i>	3,84 <i>0.151</i>	38,0 <i>1.496</i>	5,9 <i>0.232</i>	3,0 <i>0.118</i>	130°	Niepokr.
SD22-1.93-3.86-3R1	02730617	1,93 <i>0.076</i>	3,86 <i>0.152</i>	38,0 <i>1.496</i>	5,9 <i>0.232</i>	3,0 <i>0.118</i>	130°	Niepokr.
SD22-1.94-3.88-3R1	02730618	1,94 <i>0.076</i>	3,88 <i>0.153</i>	38,0 <i>1.496</i>	5,9 <i>0.232</i>	3,0 <i>0.118</i>	130°	Niepokr.
SD22-1.95-3.90-3R1	02730619	1,95 <i>0.077</i>	3,9 <i>0.154</i>	38,0 <i>1.496</i>	5,9 <i>0.232</i>	3,0 <i>0.118</i>	130°	Niepokr.
SD22-1.96-3.92-3R1	02730620	1,96 <i>0.077</i>	3,92 <i>0.154</i>	38,0 <i>1.496</i>	6,0 <i>0.236</i>	3,0 <i>0.118</i>	130°	Niepokr.
SD22-1.97-3.94-3R1	02730621	1,97 <i>0.078</i>	3,94 <i>0.155</i>	38,0 <i>1.496</i>	6,0 <i>0.236</i>	3,0 <i>0.118</i>	130°	Niepokr.
SD22-1.98-3.96-3R1	02730622	1,98 <i>0.078</i>	3,96 <i>0.156</i>	38,0 <i>1.496</i>	6,0 <i>0.236</i>	3,0 <i>0.118</i>	130°	Niepokr.
SD22-1.99-3.98-3R1	02730623	1,99 <i>0.078</i>	3,98 <i>0.157</i>	38,0 <i>1.496</i>	6,0 <i>0.236</i>	3,0 <i>0.118</i>	130°	Niepokr.
SD22-2.00-4.00-3R1	02731610	2,0 <i>0.079</i>	4,0 <i>0.157</i>	38,0 <i>1.496</i>	6,0 <i>0.236</i>	3,0 <i>0.118</i>	130°	Niepokr.

Wstęp

Wiercenie

Rozwiercanie

Wytaczanie

Załącznik

SD26

Głębokość wiercenia ~ 6 x D – Metryczne/Calowe

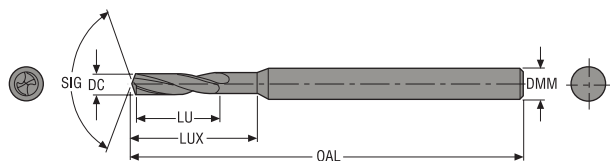

- Chwył cylindryczny
- Zewnętrzne kanały doprowadzające chłodziwo
- Parametry skrawania, patrz strona (strony) 164-168

Oznaczenie	Numer produktu	DC	LU	OAL	LUX	DMM	Kąt wierzchołkowy	Pokrycie
		mm Cal.	mm Cal.	mm Cal.	mm Cal.	mm Cal.		
SD26-0.10-0.40-3R1	02731612	0,1 0.004	0,4 0.016	38,0 1.496	0,7 0.028	3,0 0.118	130°	Niepokr.
SD26-0.11-0.40-3R1	02730624	0,11 0.004	0,4 0.016	38,0 1.496	0,7 0.028	3,0 0.118	130°	Niepokr.
SD26-0.12-0.40-3R1	02730625	0,12 0.005	0,4 0.016	38,0 1.496	0,7 0.028	3,0 0.118	130°	Niepokr.
SD26-0.13-0.65-3R1	02730626	0,13 0.005	0,65 0.026	38,0 1.496	1,0 0.039	3,0 0.118	130°	Niepokr.
SD26-0.14-0.65-3R1	02730627	0,14 0.006	0,65 0.026	38,0 1.496	1,0 0.039	3,0 0.118	130°	Niepokr.
SD26-0.15-0.65-3R1	02731613	0,15 0.006	0,9 0.035	38,0 1.496	1,4 0.055	3,0 0.118	130°	Niepokr.
SD26-0.16-0.90-3R1	02730628	0,16 0.006	0,9 0.035	38,0 1.496	1,4 0.055	3,0 0.118	130°	Niepokr.
SD26-0.17-0.90-3R1	02730629	0,17 0.007	0,9 0.035	38,0 1.496	1,4 0.055	3,0 0.118	130°	Niepokr.
SD26-0.18-0.90-3R1	02730630	0,18 0.007	0,9 0.035	38,0 1.496	1,4 0.055	3,0 0.118	130°	Niepokr.
SD26-0.19-0.90-3R1	02730631	0,19 0.007	0,9 0.035	38,0 1.496	1,4 0.055	3,0 0.118	130°	Niepokr.
SD26-0.20-1.25-3R1	02731615	0,2 0.008	1,25 0.049	38,0 1.496	1,8 0.071	3,0 0.118	130°	Niepokr.
SD26-0.21-1.25-3R1	02730632	0,21 0.008	1,25 0.049	38,0 1.496	1,8 0.071	3,0 0.118	130°	Niepokr.
SD26-0.22-1.25-3R1	02730633	0,22 0.009	1,25 0.049	38,0 1.496	1,8 0.071	3,0 0.118	130°	Niepokr.
SD26-0.23-1.25-3R1	02730634	0,23 0.009	1,25 0.049	38,0 1.496	1,8 0.071	3,0 0.118	130°	Niepokr.
SD26-0.24-1.25-3R1	02730635	0,24 0.009	1,25 0.049	38,0 1.496	1,8 0.071	3,0 0.118	130°	Niepokr.
SD26-0.25-1.55-3R1	02731617	0,25 0.010	1,55 0.061	38,0 1.496	2,2 0.087	3,0 0.118	130°	Niepokr.
SD26-0.26-1.55-3R1	02730636	0,26 0.010	1,55 0.061	38,0 1.496	2,2 0.087	3,0 0.118	130°	Niepokr.
SD26-0.27-1.55-3R1	02730637	0,27 0.011	1,55 0.061	38,0 1.496	2,2 0.087	3,0 0.118	130°	Niepokr.
SD26-0.28-1.55-3R1	02730638	0,28 0.011	1,55 0.061	38,0 1.496	2,2 0.087	3,0 0.118	130°	Niepokr.
SD26-0.29-1.55-3R1	02730639	0,29 0.011	1,55 0.061	38,0 1.496	2,2 0.087	3,0 0.118	130°	Niepokr.
SD26-0.30-1.80-3R1	02731618	0,3 0.012	1,8 0.071	38,0 1.496	2,4 0.094	3,0 0.118	130°	Niepokr.
SD26-0.31-1.80-3R1	02730640	0,31 0.012	1,8 0.071	38,0 1.496	2,4 0.094	3,0 0.118	130°	Niepokr.

Oznaczenie	Numer produktu	DC	LU	OAL	LUX	DMM	Kąt wierzchołkowy	Pokrycie
		mm Cal.	mm Cal.	mm Cal.	mm Cal.	mm Cal.		
SD26-0.32-1.80-3R1	02730641	0,32 0.013	1,8 0.071	38,0 1.496	2,4 0.094	3,0 0.118	130°	Niepokr.
SD26-0.33-1.80-3R1	02730642	0,33 0.013	1,8 0.071	38,0 1.496	2,4 0.094	3,0 0.118	130°	Niepokr.
SD26-0.34-1.80-3R1	02730643	0,34 0.013	1,8 0.071	38,0 1.496	2,4 0.094	3,0 0.118	130°	Niepokr.
SD26-0.35-2.20-3R1	02731619	0,35 0.014	2,2 0.087	38,0 1.496	2,8 0.110	3,0 0.118	130°	Niepokr.
SD26-0.36-2.20-3R1	02730644	0,36 0.014	2,2 0.087	38,0 1.496	2,8 0.110	3,0 0.118	130°	Niepokr.
SD26-0.37-2.20-3R1	02730645	0,37 0.015	2,2 0.087	38,0 1.496	2,8 0.110	3,0 0.118	130°	Niepokr.
SD26-0.38-2.20-3R1	02730646	0,38 0.015	2,2 0.087	38,0 1.496	2,8 0.110	3,0 0.118	130°	Niepokr.
SD26-0.39-2.70-3R1	02730647	0,39 0.015	2,7 0.106	38,0 1.496	3,6 0.142	3,0 0.118	130°	Niepokr.
SD26-0.40-2.70-3R1	02731620	0,4 0.016	2,7 0.106	38,0 1.496	3,6 0.142	3,0 0.118	130°	Niepokr.
SD26-0.41-2.70-3R1	02730648	0,41 0.016	2,7 0.106	38,0 1.496	3,6 0.142	3,0 0.118	130°	Niepokr.
SD26-0.42-2.70-3R1	02730649	0,42 0.017	2,7 0.106	38,0 1.496	3,6 0.142	3,0 0.118	130°	Niepokr.
SD26-0.43-2.70-3R1	02730650	0,43 0.017	2,7 0.106	38,0 1.496	3,6 0.142	3,0 0.118	130°	Niepokr.
SD26-0.44-2.70-3R1	02730651	0,44 0.017	2,7 0.106	38,0 1.496	3,6 0.142	3,0 0.118	130°	Niepokr.
SD26-0.45-2.70-3R1	02731621	0,45 0.018	2,7 0.106	38,0 1.496	3,6 0.142	3,0 0.118	130°	Niepokr.
SD26-0.46-2.70-3R1	02730652	0,46 0.018	2,7 0.106	38,0 1.496	3,6 0.142	3,0 0.118	130°	Niepokr.
SD26-0.47-2.70-3R1	02730653	0,47 0.019	2,7 0.106	38,0 1.496	3,6 0.142	3,0 0.118	130°	Niepokr.
SD26-0.48-2.70-3R1	02730654	0,48 0.019	2,7 0.106	38,0 1.496	3,6 0.142	3,0 0.118	130°	Niepokr.
SD26-0.49-3.20-3R1	02730655	0,49 0.019	3,2 0.126	38,0 1.496	4,0 0.157	3,0 0.118	130°	Niepokr.
SD26-0.50-3.20-3R1	02731622	0,5 0.020	3,2 0.126	38,0 1.496	4,0 0.157	3,0 0.118	130°	Niepokr.
SD26-0.51-3.20-3R1	02730656	0,51 0.020	3,2 0.126	38,0 1.496	4,0 0.157	3,0 0.118	130°	Niepokr.
SD26-0.52-3.20-3R1	02730657	0,52 0.020	3,2 0.126	38,0 1.496	4,0 0.157	3,0 0.118	130°	Niepokr.
SD26-0.53-3.20-3R1	02730658	0,53 0.021	3,2 0.126	38,0 1.496	4,0 0.157	3,0 0.118	130°	Niepokr.
SD26-0.54-3.60-3R1	02730659	0,54 0.021	3,6 0.142	38,0 1.496	4,5 0.177	3,0 0.118	130°	Niepokr.
SD26-0.55-3.60-3R1	02731623	0,55 0.022	3,6 0.142	38,0 1.496	4,5 0.177	3,0 0.118	130°	Niepokr.
SD26-0.56-3.60-3R1	02730660	0,56 0.022	3,6 0.142	38,0 1.496	4,5 0.177	3,0 0.118	130°	Niepokr.
SD26-0.57-3.60-3R1	02730661	0,57 0.022	3,6 0.142	38,0 1.496	4,5 0.177	3,0 0.118	130°	Niepokr.
SD26-0.58-3.60-3R1	02730662	0,58 0.023	3,6 0.142	38,0 1.496	4,5 0.177	3,0 0.118	130°	Niepokr.
SD26-0.59-3.60-3R1	02730663	0,59 0.023	3,6 0.142	38,0 1.496	4,5 0.177	3,0 0.118	130°	Niepokr.
SD26-0.60-3.60-3R1	02731624	0,6 0.024	3,6 0.142	38,0 1.496	4,5 0.177	3,0 0.118	130°	Niepokr.
SD26-0.61-3.90-3R1	02730664	0,61 0.024	3,6 0.142	38,0 1.496	4,5 0.177	3,0 0.118	130°	Niepokr.
SD26-0.62-3.90-3R1	02730665	0,62 0.024	3,9 0.154	38,0 1.496	5,0 0.197	3,0 0.118	130°	Niepokr.

Wstęp

Wiercenie

Rozwiercanie

Wytaczanie

Załącznik

Oznaczenie	Numer produktu	DC	LU	OAL	LUX	DMM	Kąt wierzchołkowy	Pokrycie
		mm Cal.	mm Cal.	mm Cal.	mm Cal.	mm Cal.		
SD26-0.63-3.90-3R1	02730666	0,63 0.025	3,9 0.154	38,0 1.496	5,0 0.197	3,0 0.118	130°	Niepokr.
SD26-0.64-3.90-3R1	02730667	0,64 0.025	3,9 0.154	38,0 1.496	5,0 0.197	3,0 0.118	130°	Niepokr.
SD26-0.65-3.90-3R1	02731625	0,65 0.026	3,9 0.154	38,0 1.496	5,0 0.197	3,0 0.118	130°	Niepokr.
SD26-0.66-3.90-3R1	02730668	0,66 0.026	3,9 0.154	38,0 1.496	5,0 0.197	3,0 0.118	130°	Niepokr.
SD26-0.67-3.90-3R1	02730669	0,67 0.026	3,9 0.154	38,0 1.496	5,0 0.197	3,0 0.118	130°	Niepokr.
SD26-0.68-4.50-3R1	02730670	0,68 0.027	4,5 0.177	38,0 1.496	5,6 0.220	3,0 0.118	130°	Niepokr.
SD26-0.69-4.50-3R1	02730671	0,69 0.027	4,5 0.177	38,0 1.496	5,6 0.220	3,0 0.118	130°	Niepokr.
SD26-0.70-4.50-3R1	02731626	0,7 0.028	4,5 0.177	38,0 1.496	5,6 0.220	3,0 0.118	130°	Niepokr.
SD26-0.71-4.50-3R1	02730672	0,71 0.028	4,5 0.177	38,0 1.496	5,6 0.220	3,0 0.118	130°	Niepokr.
SD26-0.72-4.50-3R1	02730673	0,72 0.028	4,5 0.177	38,0 1.496	5,6 0.220	3,0 0.118	130°	Niepokr.
SD26-0.73-4.50-3R1	02730674	0,73 0.029	4,5 0.177	38,0 1.496	5,6 0.220	3,0 0.118	130°	Niepokr.
SD26-0.74-4.50-3R1	02730675	0,74 0.029	4,5 0.177	38,0 1.496	5,6 0.220	3,0 0.118	130°	Niepokr.
SD26-0.75-4.50-3R1	02731627	0,75 0.030	4,5 0.177	38,0 1.496	5,6 0.220	3,0 0.118	130°	Niepokr.
SD26-0.76-5.00-3R1	02730676	0,76 0.030	5,0 0.197	38,0 1.496	6,3 0.248	3,0 0.118	130°	Niepokr.
SD26-0.77-5.00-3R1	02730677	0,77 0.030	5,0 0.197	38,0 1.496	6,3 0.248	3,0 0.118	130°	Niepokr.
SD26-0.78-5.00-3R1	02730678	0,78 0.031	5,0 0.197	38,0 1.496	6,3 0.248	3,0 0.118	130°	Niepokr.
SD26-0.79-5.00-3R1	02730679	0,79 0.031	5,0 0.197	38,0 1.496	6,3 0.248	3,0 0.118	130°	Niepokr.
SD26-0.80-5.00-3R1	02731628	0,8 0.031	5,0 0.197	38,0 1.496	6,3 0.248	3,0 0.118	130°	Niepokr.
SD26-0.81-5.00-3R1	02730680	0,81 0.032	5,0 0.197	38,0 1.496	6,3 0.248	3,0 0.118	130°	Niepokr.
SD26-0.82-5.00-3R1	02730681	0,82 0.032	5,0 0.197	38,0 1.496	6,3 0.248	3,0 0.118	130°	Niepokr.
SD26-0.83-5.00-3R1	02730682	0,83 0.033	5,0 0.197	38,0 1.496	6,3 0.248	3,0 0.118	130°	Niepokr.
SD26-0.84-5.00-3R1	02730683	0,84 0.033	5,0 0.197	38,0 1.496	6,3 0.248	3,0 0.118	130°	Niepokr.
SD26-0.85-5.00-3R1	02731629	0,85 0.033	5,0 0.197	38,0 1.496	6,3 0.248	3,0 0.118	130°	Niepokr.
SD26-0.86-5.70-3R1	02730684	0,86 0.034	5,7 0.224	38,0 1.496	7,1 0.280	3,0 0.118	130°	Niepokr.
SD26-0.87-5.70-3R1	02730685	0,87 0.034	5,7 0.224	38,0 1.496	7,1 0.280	3,0 0.118	130°	Niepokr.
SD26-0.88-5.70-3R1	02730686	0,88 0.035	5,7 0.224	38,0 1.496	7,1 0.280	3,0 0.118	130°	Niepokr.
SD26-0.89-5.70-3R1	02730687	0,89 0.035	5,7 0.224	38,0 1.496	7,1 0.280	3,0 0.118	130°	Niepokr.
SD26-0.90-5.70-3R1	02731630	0,9 0.035	5,7 0.224	38,0 1.496	7,1 0.280	3,0 0.118	130°	Niepokr.
SD26-0.91-5.70-3R1	02730688	0,91 0.036	5,7 0.224	38,0 1.496	7,1 0.280	3,0 0.118	130°	Niepokr.
SD26-0.92-5.70-3R1	02730689	0,92 0.036	5,7 0.224	38,0 1.496	7,1 0.280	3,0 0.118	130°	Niepokr.
SD26-0.93-5.70-3R1	02730690	0,93 0.037	5,7 0.224	38,0 1.496	7,1 0.280	3,0 0.118	130°	Niepokr.

Wstęp

Wiercenie

Rozwiercanie

Wyłaczanie

Załącznik

Oznaczenie	Numer produktu	DC	LU	OAL	LUX	DMM	Kąt wierzchołkowy	Pokrycie
		mm Cal.	mm Cal.	mm Cal.	mm Cal.	mm Cal.		
SD26-0.94-5.70-3R1	02730691	0,94 0.037	5,7 0.224	38,0 1.496	7,1 0.280	3,0 0.118	130°	Niepokr.
SD26-0.95-5.70-3R1	02731631	0,95 0.037	5,7 0.224	38,0 1.496	7,1 0.280	3,0 0.118	130°	Niepokr.
SD26-0.96-6.50-3R1	02730692	0,96 0.038	6,5 0.256	38,0 1.496	8,0 0.315	3,0 0.118	130°	Niepokr.
SD26-0.97-6.50-3R1	02730693	0,97 0.038	6,5 0.256	38,0 1.496	8,0 0.315	3,0 0.118	130°	Niepokr.
SD26-0.98-6.50-3R1	02730694	0,98 0.039	6,5 0.256	38,0 1.496	8,0 0.315	3,0 0.118	130°	Niepokr.
SD26-0.99-6.50-3R1	02730695	0,99 0.039	6,5 0.256	38,0 1.496	8,0 0.315	3,0 0.118	130°	Niepokr.
SD26-1.00-6.50-3R1	02731632	1,0 0.039	6,5 0.256	38,0 1.496	8,0 0.315	3,0 0.118	130°	Niepokr.
SD26-1.01-6.50-3R1	02730696	1,01 0.040	6,5 0.256	38,0 1.496	8,0 0.315	3,0 0.118	130°	Niepokr.
SD26-1.02-6.50-3R1	02730697	1,02 0.040	6,5 0.256	38,0 1.496	8,0 0.315	3,0 0.118	130°	Niepokr.
SD26-1.03-6.50-3R1	02730698	1,03 0.041	6,5 0.256	38,0 1.496	8,0 0.315	3,0 0.118	130°	Niepokr.
SD26-1.04-6.50-3R1	02730699	1,04 0.041	6,5 0.256	38,0 1.496	8,0 0.315	3,0 0.118	130°	Niepokr.
SD26-1.05-6.50-3R1	02730700	1,05 0.041	6,5 0.256	38,0 1.496	8,0 0.315	3,0 0.118	130°	Niepokr.
SD26-1.06-7.30-3R1	02730701	1,06 0.042	7,3 0.287	38,0 1.496	9,0 0.354	3,0 0.118	130°	Niepokr.
SD26-1.07-7.30-3R1	02730702	1,07 0.042	7,3 0.287	38,0 1.496	9,0 0.354	3,0 0.118	130°	Niepokr.
SD26-1.08-7.30-3R1	02730703	1,08 0.043	7,3 0.287	38,0 1.496	9,0 0.354	3,0 0.118	130°	Niepokr.
SD26-1.09-7.30-3R1	02730704	1,09 0.043	7,3 0.287	38,0 1.496	9,0 0.354	3,0 0.118	130°	Niepokr.
SD26-1.10-7.30-3R1	02731633	1,1 0.043	7,3 0.287	38,0 1.496	9,0 0.354	3,0 0.118	130°	Niepokr.
SD26-1.11-7.30-3R1	02730705	1,11 0.044	7,3 0.287	38,0 1.496	9,0 0.354	3,0 0.118	130°	Niepokr.
SD26-1.12-7.30-3R1	02730706	1,12 0.044	7,3 0.287	38,0 1.496	9,0 0.354	3,0 0.118	130°	Niepokr.
SD26-1.13-7.30-3R1	02730707	1,13 0.044	7,3 0.287	38,0 1.496	9,0 0.354	3,0 0.118	130°	Niepokr.
SD26-1.14-7.30-3R1	02730708	1,14 0.045	7,3 0.287	38,0 1.496	9,0 0.354	3,0 0.118	130°	Niepokr.
SD26-1.15-7.30-3R1	02730709	1,15 0.045	7,3 0.287	38,0 1.496	9,0 0.354	3,0 0.118	130°	Niepokr.
SD26-1.16-8.20-3R1	02730710	1,16 0.046	8,2 0.323	38,0 1.496	10,0 0.394	3,0 0.118	130°	Niepokr.
SD26-1.17-8.20-3R1	02730711	1,17 0.046	8,2 0.323	38,0 1.496	10,0 0.394	3,0 0.118	130°	Niepokr.
SD26-1.18-8.20-3R1	02730712	1,18 0.046	8,2 0.323	38,0 1.496	10,0 0.394	3,0 0.118	130°	Niepokr.
SD26-1.19-8.20-3R1	02730713	1,19 0.047	8,2 0.323	38,0 1.496	10,0 0.394	3,0 0.118	130°	Niepokr.
SD26-1.20-8.20-3R1	02731634	1,2 0.047	8,2 0.323	38,0 1.496	10,0 0.394	3,0 0.118	130°	Niepokr.
SD26-1.21-8.20-3R1	02730714	1,21 0.048	8,2 0.323	38,0 1.496	10,0 0.394	3,0 0.118	130°	Niepokr.
SD26-1.22-8.20-3R1	02730715	1,22 0.048	8,2 0.323	38,0 1.496	10,0 0.394	3,0 0.118	130°	Niepokr.
SD26-1.23-8.20-3R1	02730716	1,23 0.048	8,2 0.323	38,0 1.496	10,0 0.394	3,0 0.118	130°	Niepokr.
SD26-1.24-8.20-3R1	02730717	1,24 0.049	8,2 0.323	38,0 1.496	10,0 0.394	3,0 0.118	130°	Niepokr.

Wstęp

Wiercenie

Rozwiercanie

Wyłaczanie

Załącznik

Oznaczenie	Numer produktu	DC	LU	OAL	LUX	DMM	Kąt wierzchołkowy	Pokrycie
		mm Cal.	mm Cal.	mm Cal.	mm Cal.	mm Cal.		
SD26-1.25-8.20-3R1	02730718	1,25 0.049	8,2 0.323	38,0 1.496	10,0 0.394	3,0 0.118	130°	Niepokr.
SD26-1.26-8.20-3R1	02730719	1,26 0.050	8,2 0.323	38,0 1.496	10,0 0.394	3,0 0.118	130°	Niepokr.
SD26-1.27-8.20-3R1	02730720	1,27 0.050	8,2 0.323	38,0 1.496	10,0 0.394	3,0 0.118	130°	Niepokr.
SD26-1.28-8.20-3R1	02730721	1,28 0.050	8,2 0.323	38,0 1.496	10,0 0.394	3,0 0.118	130°	Niepokr.
SD26-1.29-8.20-3R1	02730722	1,29 0.051	8,2 0.323	38,0 1.496	10,0 0.394	3,0 0.118	130°	Niepokr.
SD26-1.30-8.20-3R1	02731635	1,3 0.051	8,2 0.323	38,0 1.496	10,0 0.394	3,0 0.118	130°	Niepokr.
SD26-1.31-9.20-3R1	02730723	1,31 0.052	9,2 0.362	38,0 1.496	11,2 0.441	3,0 0.118	130°	Niepokr.
SD26-1.32-9.20-3R1	02730724	1,32 0.052	9,2 0.362	38,0 1.496	11,2 0.441	3,0 0.118	130°	Niepokr.
SD26-1.33-9.20-3R1	02730725	1,33 0.052	9,2 0.362	38,0 1.496	11,2 0.441	3,0 0.118	130°	Niepokr.
SD26-1.34-9.20-3R1	02730726	1,34 0.053	9,2 0.362	38,0 1.496	11,2 0.441	3,0 0.118	130°	Niepokr.
SD26-1.35-9.20-3R1	02730727	1,35 0.053	9,2 0.362	38,0 1.496	11,2 0.441	3,0 0.118	130°	Niepokr.
SD26-1.36-9.20-3R1	02730728	1,36 0.054	9,2 0.362	38,0 1.496	11,2 0.441	3,0 0.118	130°	Niepokr.
SD26-1.37-9.20-3R1	02730729	1,37 0.054	9,2 0.362	38,0 1.496	11,2 0.441	3,0 0.118	130°	Niepokr.
SD26-1.38-9.20-3R1	02730730	1,38 0.054	9,2 0.362	38,0 1.496	11,2 0.441	3,0 0.118	130°	Niepokr.
SD26-1.39-9.20-3R1	02730731	1,39 0.055	9,2 0.362	38,0 1.496	11,2 0.441	3,0 0.118	130°	Niepokr.
SD26-1.40-9.20-3R1	02731637	1,4 0.055	9,2 0.362	38,0 1.496	11,2 0.441	3,0 0.118	130°	Niepokr.
SD26-1.41-9.20-3R1	02730732	1,41 0.056	9,2 0.362	38,0 1.496	11,2 0.441	3,0 0.118	130°	Niepokr.
SD26-1.42-9.20-3R1	02730733	1,42 0.056	9,2 0.362	38,0 1.496	11,2 0.441	3,0 0.118	130°	Niepokr.
SD26-1.43-9.20-3R1	02730734	1,43 0.056	9,2 0.362	38,0 1.496	11,2 0.441	3,0 0.118	130°	Niepokr.
SD26-1.44-9.20-3R1	02730735	1,44 0.057	9,2 0.362	38,0 1.496	11,2 0.441	3,0 0.118	130°	Niepokr.
SD26-1.45-9.20-3R1	02730736	1,45 0.057	9,2 0.362	38,0 1.496	11,2 0.441	3,0 0.118	130°	Niepokr.
SD26-1.46-9.20-3R1	02730737	1,46 0.057	9,2 0.362	38,0 1.496	11,2 0.441	3,0 0.118	130°	Niepokr.
SD26-1.47-9.20-3R1	02730738	1,47 0.058	9,2 0.362	38,0 1.496	11,2 0.441	3,0 0.118	130°	Niepokr.
SD26-1.48-9.20-3R1	02730739	1,48 0.058	9,2 0.362	38,0 1.496	11,2 0.441	3,0 0.118	130°	Niepokr.
SD26-1.49-9.20-3R1	02730740	1,49 0.059	9,2 0.362	38,0 1.496	11,2 0.441	3,0 0.118	130°	Niepokr.
SD26-1.50-9.20-3R1	02731638	1,5 0.059	9,2 0.362	38,0 1.496	11,2 0.441	3,0 0.118	130°	Niepokr.
SD26-1.51-11.20-3R1	02730741	1,51 0.059	11,2 0.441	38,0 1.496	13,4 0.528	3,0 0.118	130°	Niepokr.
SD26-1.52-11.20-3R1	02730742	1,52 0.060	11,2 0.441	38,0 1.496	13,4 0.528	3,0 0.118	130°	Niepokr.
SD26-1.53-11.20-3R1	02730743	1,53 0.060	11,2 0.441	38,0 1.496	13,4 0.528	3,0 0.118	130°	Niepokr.
SD26-1.54-11.20-3R1	02730744	1,54 0.061	11,2 0.441	38,0 1.496	13,4 0.528	3,0 0.118	130°	Niepokr.
SD26-1.55-11.20-3R1	02730745	1,55 0.061	11,2 0.441	38,0 1.496	13,4 0.528	3,0 0.118	130°	Niepokr.

Oznaczenie	Numer produktu	DC	LU	OAL	LUX	DMM	Kąt wierzchołkowy	Pokrycie
		mm Cal.	mm Cal.	mm Cal.	mm Cal.	mm Cal.		
SD26-1.56-11.20-3R1	02730746	1,56 0.061	11,2 0.441	38,0 1.496	13,4 0.528	3,0 0.118	130°	Niepokr.
SD26-1.57-11.20-3R1	02730747	1,57 0.062	11,2 0.441	38,0 1.496	13,4 0.528	3,0 0.118	130°	Niepokr.
SD26-1.58-11.20-3R1	02730748	1,58 0.062	11,2 0.441	38,0 1.496	13,4 0.528	3,0 0.118	130°	Niepokr.
SD26-1.59-11.20-3R1	02730749	1,59 0.063	11,2 0.441	38,0 1.496	13,4 0.528	3,0 0.118	130°	Niepokr.
SD26-1.60-11.20-3R1	02731639	1,6 0.063	11,2 0.441	38,0 1.496	13,4 0.528	3,0 0.118	130°	Niepokr.
SD26-1.61-11.20-3R1	02730750	1,61 0.063	11,2 0.441	38,0 1.496	13,4 0.528	3,0 0.118	130°	Niepokr.
SD26-1.62-11.20-3R1	02730751	1,62 0.064	11,2 0.441	38,0 1.496	13,4 0.528	3,0 0.118	130°	Niepokr.
SD26-1.63-11.20-3R1	02730752	1,63 0.064	11,2 0.441	38,0 1.496	13,4 0.528	3,0 0.118	130°	Niepokr.
SD26-1.64-11.20-3R1	02730753	1,64 0.065	11,2 0.441	38,0 1.496	13,4 0.528	3,0 0.118	130°	Niepokr.
SD26-1.65-11.20-3R1	02730754	1,65 0.065	11,2 0.441	38,0 1.496	13,4 0.528	3,0 0.118	130°	Niepokr.
SD26-1.66-11.20-3R1	02730755	1,66 0.065	11,2 0.441	38,0 1.496	13,4 0.528	3,0 0.118	130°	Niepokr.
SD26-1.67-11.20-3R1	02730756	1,67 0.066	11,2 0.441	38,0 1.496	13,4 0.528	3,0 0.118	130°	Niepokr.
SD26-1.68-11.20-3R1	02730757	1,68 0.066	11,2 0.441	38,0 1.496	13,4 0.528	3,0 0.118	130°	Niepokr.
SD26-1.69-11.20-3R1	02730758	1,69 0.067	11,2 0.441	38,0 1.496	13,4 0.528	3,0 0.118	130°	Niepokr.
SD26-1.70-11.20-3R1	02731640	1,7 0.067	11,2 0.441	38,0 1.496	13,4 0.528	3,0 0.118	130°	Niepokr.
SD26-1.71-11.20-3R1	02730759	1,71 0.067	11,2 0.441	38,0 1.496	13,4 0.528	3,0 0.118	130°	Niepokr.
SD26-1.72-11.20-3R1	02730760	1,72 0.068	11,2 0.441	38,0 1.496	13,4 0.528	3,0 0.118	130°	Niepokr.
SD26-1.73-11.20-3R1	02730761	1,73 0.068	11,2 0.441	38,0 1.496	13,4 0.528	3,0 0.118	130°	Niepokr.
SD26-1.74-11.20-3R1	02730762	1,74 0.069	11,2 0.441	38,0 1.496	13,4 0.528	3,0 0.118	130°	Niepokr.
SD26-1.75-11.20-3R1	02730763	1,75 0.069	11,2 0.441	38,0 1.496	13,4 0.528	3,0 0.118	130°	Niepokr.
SD26-1.76-11.20-3R1	02730764	1,76 0.069	11,2 0.441	38,0 1.496	13,4 0.528	3,0 0.118	130°	Niepokr.
SD26-1.77-11.20-3R1	02730765	1,77 0.070	11,2 0.441	38,0 1.496	13,4 0.528	3,0 0.118	130°	Niepokr.
SD26-1.78-11.20-3R1	02730766	1,78 0.070	11,2 0.441	38,0 1.496	13,4 0.528	3,0 0.118	130°	Niepokr.
SD26-1.79-11.20-3R1	02730767	1,79 0.070	11,2 0.441	38,0 1.496	13,4 0.528	3,0 0.118	130°	Niepokr.
SD26-1.80-11.20-3R1	02731641	1,8 0.071	11,2 0.441	38,0 1.496	13,4 0.528	3,0 0.118	130°	Niepokr.
SD26-1.81-11.20-3R1	02730768	1,81 0.071	11,2 0.441	38,0 1.496	13,4 0.528	3,0 0.118	130°	Niepokr.
SD26-1.82-11.20-3R1	02730769	1,82 0.072	11,2 0.441	38,0 1.496	13,4 0.528	3,0 0.118	130°	Niepokr.
SD26-1.83-11.20-3R1	02730770	1,83 0.072	11,2 0.441	38,0 1.496	13,4 0.528	3,0 0.118	130°	Niepokr.
SD26-1.84-11.20-3R1	02730771	1,84 0.072	11,2 0.441	38,0 1.496	13,4 0.528	3,0 0.118	130°	Niepokr.
SD26-1.85-11.20-3R1	02730772	1,85 0.073	11,2 0.441	38,0 1.496	13,4 0.528	3,0 0.118	130°	Niepokr.
SD26-1.86-11.20-3R1	02730773	1,86 0.073	11,2 0.441	38,0 1.496	13,4 0.528	3,0 0.118	130°	Niepokr.

Wstęp

Wiercenie

Rozwiercanie

Wytaczanie

Załącznik

Oznaczenie	Numer produktu	DC	LU	OAL	LUX	DMM	Kąt wierzchołkowy	Pokrycie
		mm Cal.	mm Cal.	mm Cal.	mm Cal.	mm Cal.		
SD26-1.87-11.20-3R1	02730774	1,87 0.074	11,2 0.441	38,0 1.496	13,4 0.528	3,0 0.118	130°	Niepokr.
SD26-1.88-11.20-3R1	02730775	1,88 0.074	11,2 0.441	38,0 1.496	13,4 0.528	3,0 0.118	130°	Niepokr.
SD26-1.89-11.20-3R1	02730776	1,89 0.074	11,2 0.441	38,0 1.496	13,4 0.528	3,0 0.118	130°	Niepokr.
SD26-1.90-11.20-3R1	02731642	1,9 0.075	11,2 0.441	38,0 1.496	13,4 0.528	3,0 0.118	130°	Niepokr.
SD26-1.91-11.20-3R1	02730777	1,91 0.075	11,2 0.441	38,0 1.496	13,4 0.528	3,0 0.118	130°	Niepokr.
SD26-1.92-11.20-3R1	02730778	1,92 0.076	11,2 0.441	38,0 1.496	13,4 0.528	3,0 0.118	130°	Niepokr.
SD26-1.93-11.20-3R1	02730779	1,93 0.076	11,2 0.441	38,0 1.496	13,4 0.528	3,0 0.118	130°	Niepokr.
SD26-1.94-11.20-3R1	02730780	1,94 0.076	11,2 0.441	38,0 1.496	13,4 0.528	3,0 0.118	130°	Niepokr.
SD26-1.95-11.20-3R1	02730781	1,95 0.077	11,2 0.441	38,0 1.496	13,4 0.528	3,0 0.118	130°	Niepokr.
SD26-1.96-11.20-3R1	02730782	1,96 0.077	11,2 0.441	38,0 1.496	13,4 0.528	3,0 0.118	130°	Niepokr.
SD26-1.97-11.20-3R1	02730783	1,97 0.078	11,2 0.441	38,0 1.496	13,4 0.528	3,0 0.118	130°	Niepokr.
SD26-1.98-11.20-3R1	02730784	1,98 0.078	11,2 0.441	38,0 1.496	13,4 0.528	3,0 0.118	130°	Niepokr.
SD26-1.99-11.20-3R1	02730785	1,99 0.078	11,2 0.441	38,0 1.496	13,4 0.528	3,0 0.118	130°	Niepokr.
SD26-2.00-11.20-3R1	02731643	2,0 0.079	11,2 0.441	38,0 1.496	13,4 0.528	3,0 0.118	130°	Niepokr.

Parametry skrawania

Zapotrzebowanie na moc

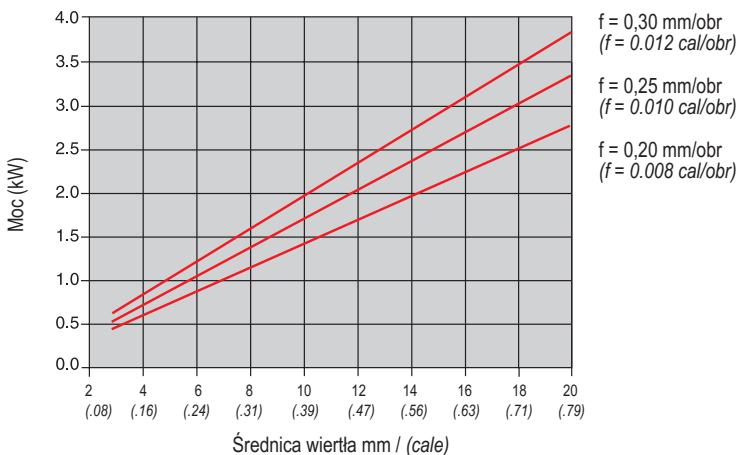

Przepływ chłodziwa przy różnych ciśnieniach

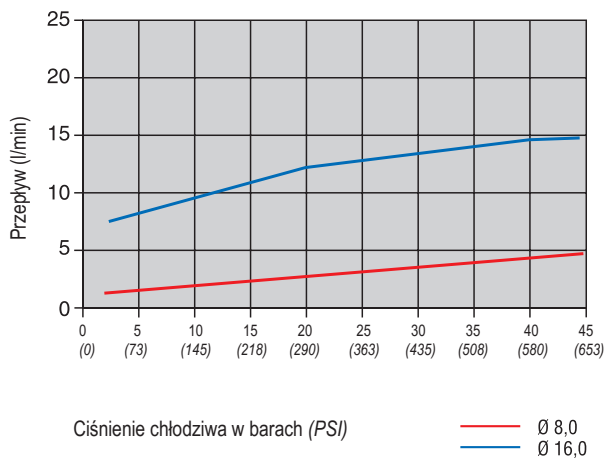

Siła od posuwu

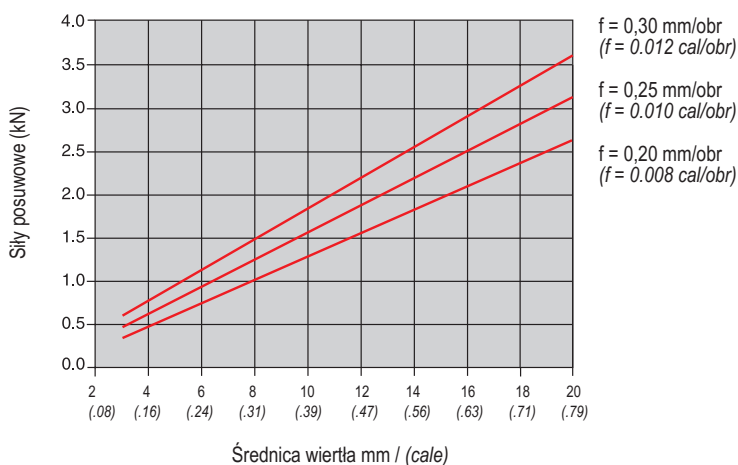

Metoda:
Dobrać posuw dla uzyskania dobrego łamania wióra.
Zwiększyć posuw na obrót aby uzyskać krótszy wiór.

Wartości pokazujące zapotrzebowanie na moc i siłę posuwu są orientacyjne i ulegają zmianie w zależności od parameterów skrawania, materiału i zużycia narzędzia.



Parametry skrawania

SD1103, SD1103A, SD1105A, SD203A, SD205A, SD206, SD206A, SD207A, SD216A, SD230A IT8-9/R _A 1-3*					
Wiertło Ø DC (mm)	Tolerancja IT9 (µm)	Tolerancja IT10 (µm)	Wiertło Ø DC (cale)	Tolerancja IT9 (cale)	Tolerancja IT10 (cale)
< 3	14	25	-0.118	0.0006	0.0010
3-6	18	30	> 0.118-0.236	0.0007	0.0012
6-10	22	36	> 0.236-0.394	0.0009	0.0014
10-18	27	43	> 0.394-0.709	0.0011	0.0017
> 18	33	52	> 0.709	0.0013	0.0020

*W przypadku wiercenia w stali niskowęglowej lub nierdzewnej może wystąpić pogorszenie chropowatości.

Rozwiązywanie problemów – Co sprawdzić na początku

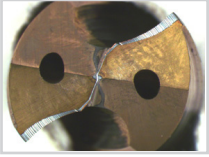
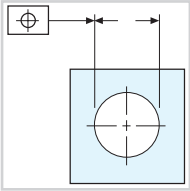
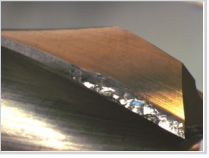
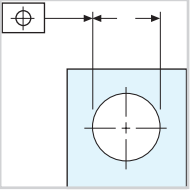
- Stabilność mocowania
- Stan techniczny wrzeciona
- Stan techniczny oprawki
- Mocowanie narzędzia:
 - Bicie w granicach 0,04 TIR
 - W przypadku nawiercania w granicach 0,04 TIR
- Usuwanie wiórów:
 - Parametry skrawania
- Chłodzenie:
 - Ciśnienie
 - Wydatek
 - Koncentracja

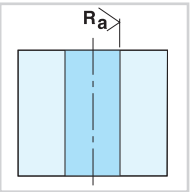
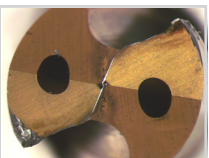
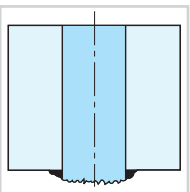
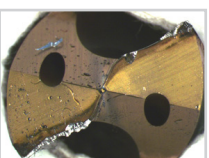
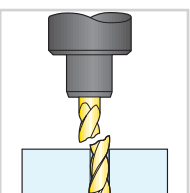
<p>Szybkie zużycie pow. przyłożenia</p> <ul style="list-style-type: none"> • Zredukować prędkość skrawania • Zwiększyć koncentrację chłodziwa 		<p>Zła tolerancja średnicy.</p> <ul style="list-style-type: none"> • Zwiększyć posuw/obr. • Zastosować rozwieranie, patrz str. 322 • Zastosować wytaczanie, patrz str. 492-493 	
<p>Zużycie zewnętrznej łysinki</p> <ul style="list-style-type: none"> • Zredukować prędkość skrawania • Zwiększyć koncentrację chłodziwa 		<p>Złe położenie otworu</p> <ul style="list-style-type: none"> • Zredukować posuw/obr na wejściu • Zredukować posuw/obr • Zastosować wytaczanie, patrz str. 492-493 • Jeśli wiercimy w surowej, twardej lub pochylonej powierzchni - zredukować posuw o 30-50% przy wejściu i wyjściu • Nawiertak o kącie ostrza 140° 	
<p>Wykruszenia ostrza wiertła</p> <ul style="list-style-type: none"> • Zmniejszyć posuw/obrót na wejściu • Zmniejszyć posuw/obrót • Zastosować wytaczanie, patrz str. 492-493 		<p>Zła gładkość powierzchni</p> <ul style="list-style-type: none"> • Zredukować posuw/obr • Zwiększyć prędkość skrawania. • Zastosuj rozwieranie, patrz str. 322 	
<p>Wykruszenie/Krawędź zewnętrzna</p> <ul style="list-style-type: none"> • Zredukować posuw na wejściu/wyjściu • Zredukować prędkość skrawania • Zwiększyć koncentrację chłodziwa • Przeostrzyć wiertło 		<p>Zadziory na wyjściu z materiału</p> <ul style="list-style-type: none"> • Zredukować posuw/obr na wyjściu • Zredukować szerokość zabezpieczenia krawędzi (BN) 	
<p>Narost na krawędzi</p> <ul style="list-style-type: none"> • Jeśli blisko średnicy zewn. zwiększyć prędkość skrawania. • Jeśli bliżej środka zwiększyć posuw/obr. • Jeśli wiertło zużyte, przeostrzyć 		<p>Złamanie wiertła na wejściu/dnie otworu</p> <ul style="list-style-type: none"> • Zredukować posuw/obr podczas wejścia/wyjścia • Zmienić parametry skrawania w celu poprawy ewakuacji wiórów 	

Instrukcje ostrzenia dla wiertel SD1103, SD1103A, SD1105A, SD1108A i SD1112A

Warunki techniczne:

Proponowany kształt ściernicy diamentowej:

Kąt przyłożenia: Kształt ściernicy 12A2 wielkość ziarna D54 (rys. 1).

Rowek wiórowy: Kształt ściernicy 1A1 lub 1V1 wielkość ziarna D64-D46 (rys. 2-3).

Faza na narożu: Kształt ściernicy 1A1 lub 12A2 (rys. 1).

Zabezp. krawędzi: szlifowanie płaszczyz. K lub szczotkowanie (rys. 4).

Ważne:

- Krawędzie skrawające powinny być równe, a łysinka tej samej wielkości.
- Łysinka powinna występować na całej długości krawędzi skrawających.

1. Punkt czterech faset

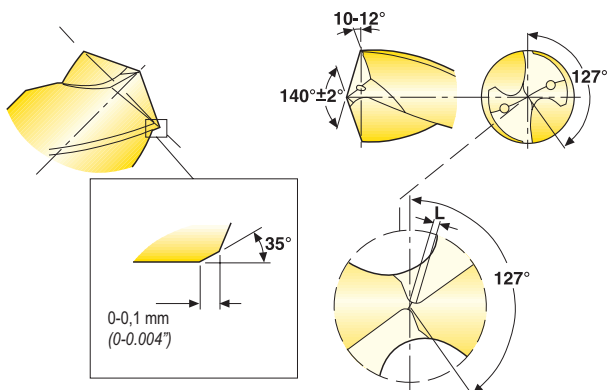

Bicie wzdłużne (bicie osiowe) powinno być w granicach 0,02 mm (0.008")

2. Skracanie ścinu

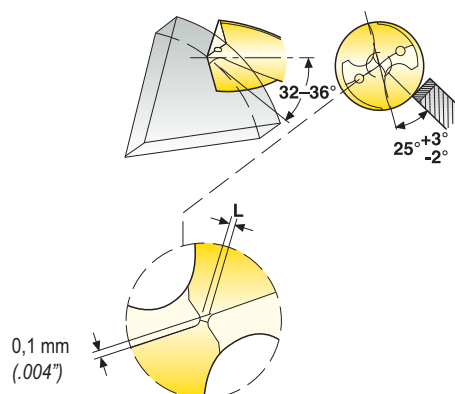

Wiertło Ø DC mm	L mm	Wiertło Ø DC cale	L cale
2-10	0,1-0,3	0.079-0.394	0.004-0.012
10-20	0,2-0,4	0.394-0.787	0.008-0.016

3. Szlifowanie spłaszczenia X

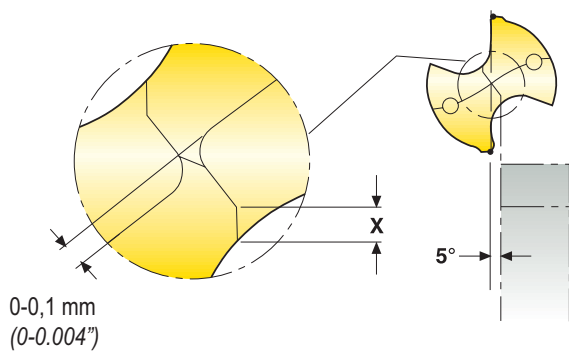

$$X = 0,08 \times (0.003") \times \text{średnica wiertła DC}$$

4. Zabezp. krawędzi

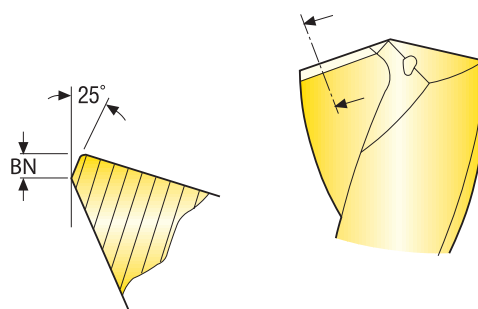

Materiał elementu obrabianego	BN			
	Wiertło Ø ≤ 10 mm	Wiertło Ø > 10 mm	Wiertło Ø ≤ 0.394 cale	Wiertło Ø > 0.394 cale
Stal	0,05	0,10	0.002	0.004
Stal nierdzewna	0,05	0,05	0.002	0.002
Żeliwo	0,05	0,10	0.002	0.004

Maks. dopuszczalne zużycie powierzchni przyłożenia przed przeszlifowaniem to 0,1 - 0,3 mm (0.004-0.012") w największym punkcie.

Instrukcja ostrzenia dla wiertel SD203A, SD205A i SD207A geometria -P

Warunki techniczne:

Proponowany kształt ściernicy diamentowej:

Kąt przyłożenia na stożku: Kształt ściernicy 12A2 wielkość ziarna D54 (rys. 1).

Rowek wiórowy: Kształt ściernicy 1A1 lub 1V1 wielkość ziarna D64-D46 (rys. 2-3).

Faza na narożu: Kształt ściernicy 1A1 lub 12A2 (rys. 1).

Zabsep. krawędzi: szlifowanie płaszcz. K lub szczotkowanie (rys. 4).

Ważne:

- Krawędzie skrawające powinny być równe, a lysinka tej samej wielkości.
- Lysinka powinna występować na całej długości krawędzi skrawających.

1. Stożkowa powierzchnia przyłożenia

Bicie wzdłużne (bicie osiowe) powinno być w granicach 0,02 mm (0,008")

2. Skracanie ścinu

Wiertło Ø DC mm	L mm	Wiertło Ø DC cale	L cale
2-10	0,1-0,3	0.079-0.394	0.004-0.012
10-20	0,2-0,4	0.394-0.787	0.008-0.016

3. Szlifowanie spłaszczenia X

$X = 0,08 \times (0,003") \times \text{średnica wiertła DC}$

4. Zabsep. krawędzi

Materiał elementu obrabianego	BN			
	Wiertło Ø ≤ 10 mm	Wiertło Ø > 10 mm	Wiertło Ø ≤ 0.394 cale	Wiertło Ø > 0.394 cale
Stal	0,05	0,10	0.002	0.004
Stal nierdzewna	0,05	0,05	0.002	0.002
Żeliwo	0,05	0,10	0.002	0.004

Maks. dopuszczalne zużycie powierzchni przyłożenia przed przeszlifowaniem to 0,1 - 0,3 mm (0,004-0,012") w największym punkcie.

Wskazówki dotyczące ostrzenia wiertel fazujących

Instrukcje są takie same jak dla SD203, SD203A, SD205A i SD207A za wyjątkiem części wykonującej fazę.

Wstęp

Wiercenie

Rozwiercanie

Wytaczanie

Załącznik

1. Kat przyłożenia ostrza

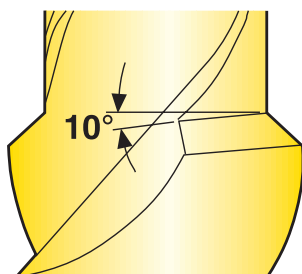

2. Zabezpieczenie krawędzi, ostrze fazujące

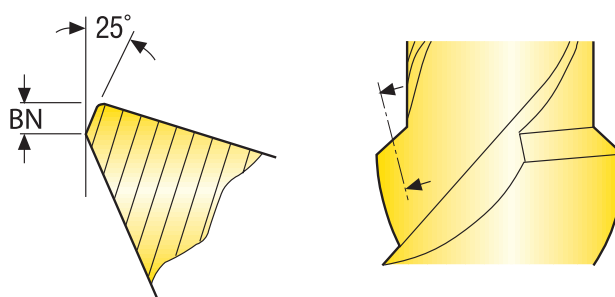

Materiał elementu obrabianego	BN			
	Wiertło $\varnothing \leq 10$ mm	Wiertło $\varnothing > 10$ mm	Wiertło $\varnothing \leq 0.394$ cale	Wiertło $\varnothing > 0.394$ cale
Stal	0,05	0,05	0,002	0,002
Stal nierdzewna	0,05	0,05	0,002	0,002
Żeliwo	0,05	0,05	0,002	0,002

Instrukcje ostrzenia dla wiertel SD212A, SD216A, SD220A, SD225A i SD230A

Warunki techniczne:

Proponowany kształt ściernicy diamentowej:

Kąt przyłożenia: Kształt ściernicy 12A2 wielkość ziarna D54 (rys. 1).

Rowek wiórowy: Kształt ściernicy 1A1 lub 1V1 wielkość ziarna D64-D46 (rys. 2-3).

Faza na narożu: Kształt ściernicy 1A1 lub 12A2 (rys. 1).

Zabezp. krawędzi: szlifowanie płaszczyzn K lub szcztokowanie (rys. 4).

Ważne:

- Krawędzie skrawające powinny być równe, a lysinka tej samej wielkości.
- Zabezpieczenie krawędzi powinno występować na całej długości.

1. Stożkowa powierzchnia przyłożenia

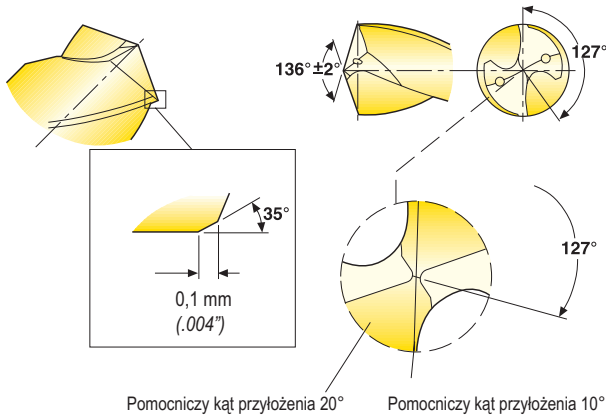

Bicie wzdłużne (bicie osiowe) powinno być w granicach 0,02 mm (0.008")

2. Skracanie ścinu

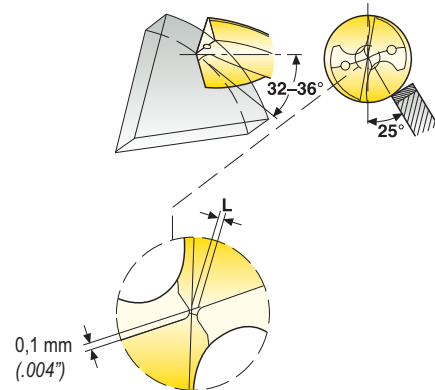

Wiertło Ø DC mm	L mm	Wiertło Ø DC cale	L cale
2-10	0,2	0.079-0.394	0.008
10-20	0,4	0.394-0.787	0.016

3. Szlifowanie spłaszczenia X

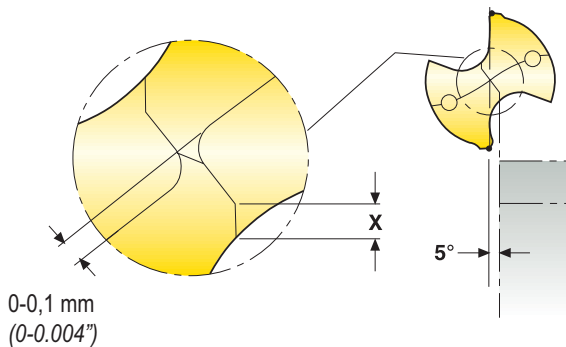

$X = 0,08 \times (0.003) \times \text{średnica wiertła DC}$

4. Zabezp. krawędzi

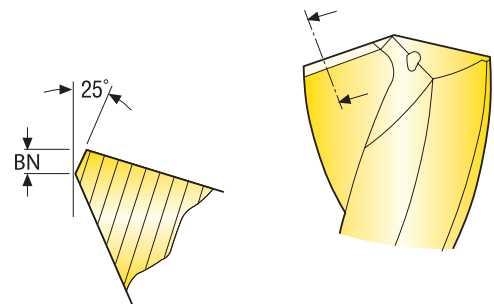

Materiał elementu obrabianego	BN			
	Wiertło Ø ≤ 10 mm	Wiertło Ø > 10 mm	Wiertło Ø ≤ 0.394 cale	Wiertło Ø > 0.394 cale
Stal	0,05	0,10	0.002	0.004
Stal nierdzewna	0,05	0,05	0.002	0.002
Żeliwo	0,05	0,10	0.002	0.004

Maks. dopuszczalne zużycie powierzchni przyłożenia przed przeszlifowaniem to 0,1 - 0,3 mm (0.004-0.012") w największym punkcie.

Instrukcje odnośnie ostrzenia dla SD243A, SD245A i SD247A

Wstęp

Wiercenie

Rozwiercanie

Wyłaczanie

Załącznik

1. Kąt wierzchołkowy

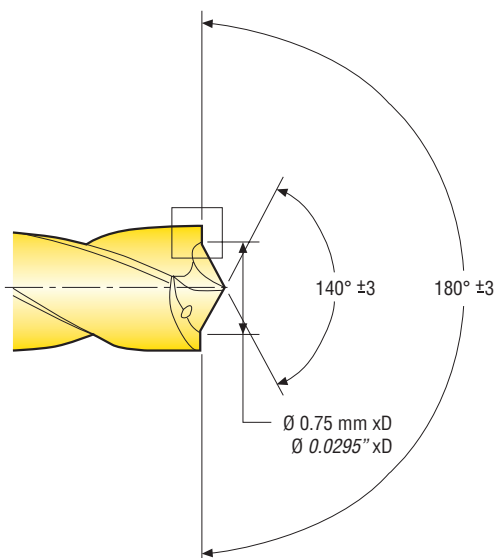

2. Faza na narożu

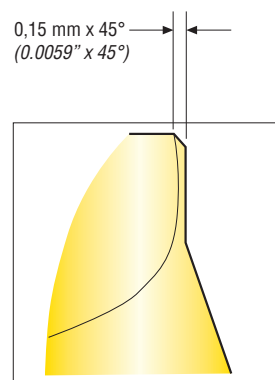

3.

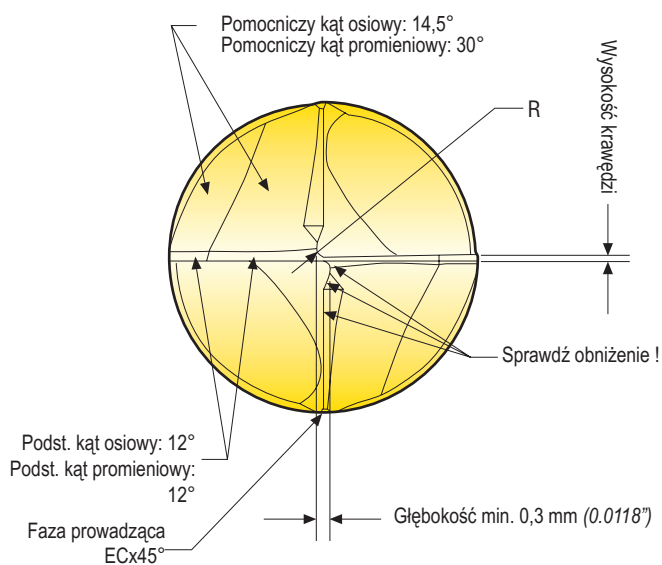

Wymiary w mm (cale)	Wysokość krawędzi mm (cale)	R mm (cale)	EC mm (cale)
- 10 (0.3937)	0,2 (0.0079)	0,2 (0.0079)	0,3 (0.0118)
10,01 (0.3941) –	0,3 (0.0118)	0,4 (0.0157)	0,5 (0.0197)

4. Zabezp. krawędzi

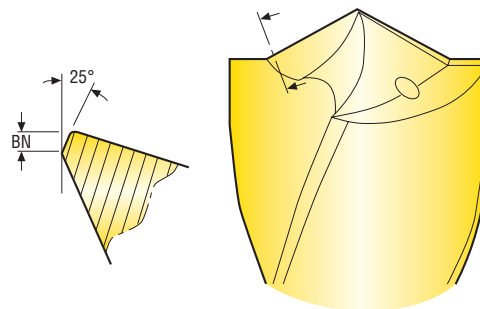

Materiał elementu obrabianego	BN			
	Wiertło Ø ≤ 10 mm	Wiertło Ø > 10 mm	Wiertło Ø ≤ 0.394 cale	Wiertło Ø > 0.394 cale
Stal	0,05	0,10	0,002	0,004
Stal nierdzewna	0,05	0,05	0,002	0,002
Żeliwo	0,05	0,10	0,002	0,004

Instrukcja ostrzenia dla SD265A

Warunki techniczne:

Proponowany kształt ściernicy diamentowej:

Kąt przyłożenia na stożku: Kształt ściernicy 12A2 wielkość ziarna D54 (rys. 1).

Rowek wiórowy: Kształt ściernicy 1A1 lub 1V1 wielkość ziarna D64-D46 (rys. 2-3).

Faza na narożu: Kształt ściernicy 1A1 lub 12A2 (rys. 1).

Zabezp. krawędzi: szlifowanie płaszc. K lub szcztokowanie (rys. 4).

Ważne:

- Krawędzie skrawające powinny być równe, a lysinka tej samej wielkości.
- Zabezpieczenie krawędzi powinno występować na całej długości.

1. Stożkowa powierzchnia przyłożenia

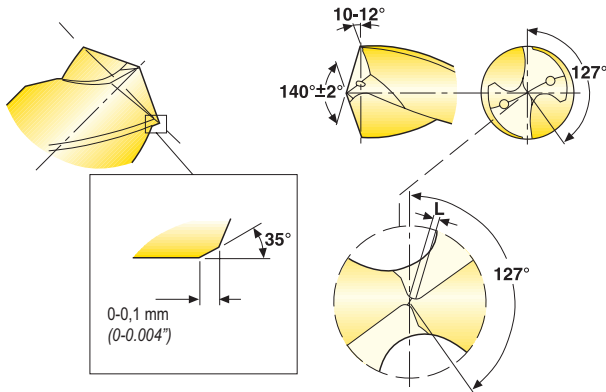

Bicie wzdłużne (bicie osiowe) powinno być w granicach 0,02 mm (0.008")

2. Skracanie ścinu

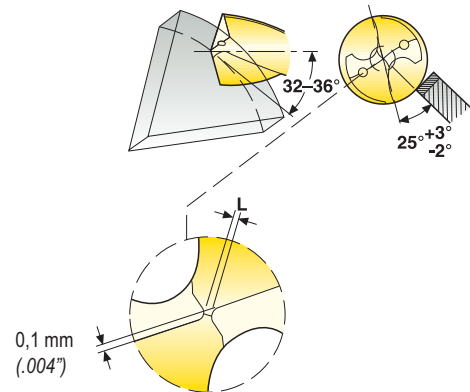

Wiertło Ø DC mm	L mm	Wiertło Ø DC cale	L cale
2-10	0,2	0.079-0.394	0.008
10-20	0,4	0.394-0.787	0.016

3. Szlifowanie spłaszczenia X

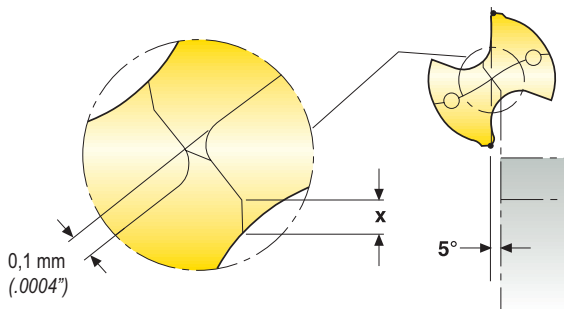

$X = 0,08 \times (0.003") \times \text{średnica wiertła DC}$

4. Zabezp. krawędzi

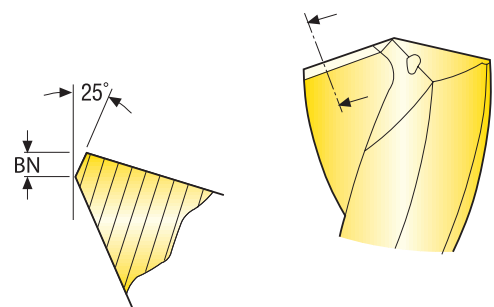

Materiał elementu obrabianego	BN			
	Wiertło Ø ≤ 10 mm	Wiertło Ø > 10 mm	Wiertło Ø ≤ 0.394 cale	Wiertło Ø > 0.394 cale
Stal	0,05	0,10	0.002	0.004
Stal nierdzewna	0,05	0,05	0.002	0.002
Żeliwo	0,05	0,10	0.002	0.004

Maks. dopuszczalne zużycie powierzchni przyłożenia przed przeszlifowaniem to 0,1 - 0,3 mm (0.004-0.012") w największym punkcie.

Instrukcja ostrzenia dla geometrii -MS

Warunki techniczne:

Proponowany kształt ściernicy diamentowej:

Kąt przyłożenia na stożku: Kształt ściernicy 12A2 wielkość ziarna D54 (rys. 1).

Rowek wiórowy: Kształt ściernicy 1A1 lub 1V1 wielkość ziarna D64-D46 (rys. 2-3).

Faza na narożu: Kształt ściernicy 1A1 lub 12A2 (rys. 1).

Zabezp. krawędzi: szlifowanie płaszcz. K lub szczotkowanie (rys. 4).

Ważne:

- Krawędzie skrawające powinny być równe, a łysinka tej samej wielkości.
- Zabezpieczenie krawędzi powinno występować na całej długości.

1. Cztery powierzchnie czołowe

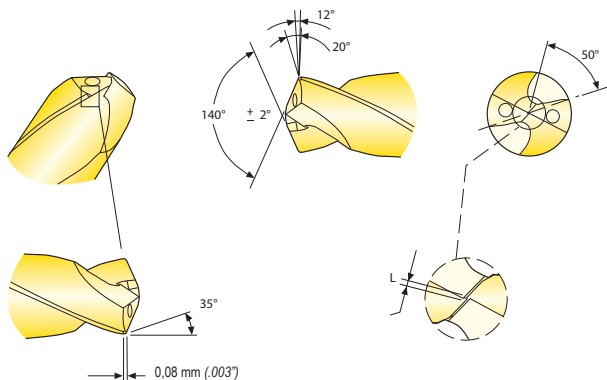

Bicie wzdłużne (bicie osiowe) powinno być w granicach 0,02 mm (0.008")

2. Szlifowanie promienia R

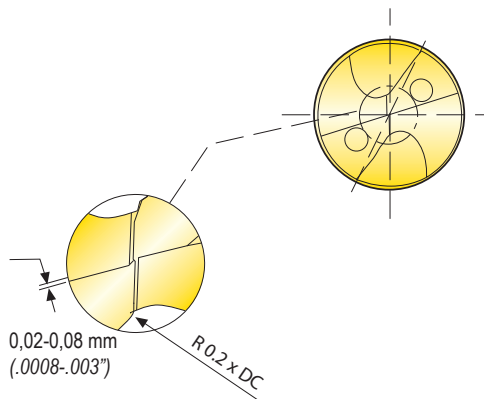

3. Skracanie ścienu

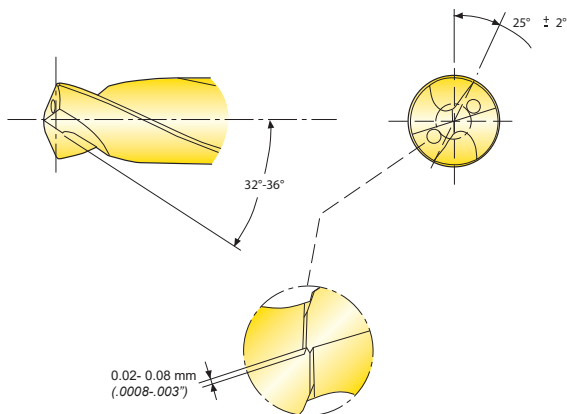

4. Zabezp. krawędzi

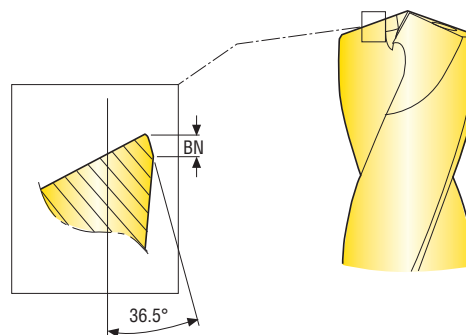

Wiertło \varnothing DC mm	BN mm	Wiertło \varnothing DC cale	BN cale
2-3	0,2	0.079-0.118	0.00787
3-6	0,025	0.118-0.236	0.00098
6-10	0,04	0.236-0.394	0.00157
10-20	0,055	0.394-0.787	0.00216
20-	0,07	0.787-	0.00275

Maks. dopuszczalne zużycie powierzchni przyłożenia przed przeszlifowaniem to 0,1 - 0,3 mm (0.004-0.012") w największym punkcie.

Instrukcje ostrzenia dla geometrii -M i -T

Warunki techniczne:

Proponowany kształt ściernicy diamentowej:

Kąt przyłożenia na stożku: Kształt ściernicy 12A2 wielkość ziarna D54 (rys. 1).

Rowek wiórowy: Kształt ściernicy 1A1 lub 1V1 wielkość ziarna D64-D46 (rys. 2-3).

Faza na narożu: Kształt ściernicy 1A1 lub 12A2 (rys. 1).

Zabezp. krawędzi: szlifowanie płaszc. K lub szczotkowanie (rys. 4).

Ważne:

- Krawędzie skrawające powinny być równe, a lysinka tej samej wielkości.
- Zabezpieczenie krawędzi powinno występować na całej długości.

1. Stożkowa powierzchnia przyłożenia

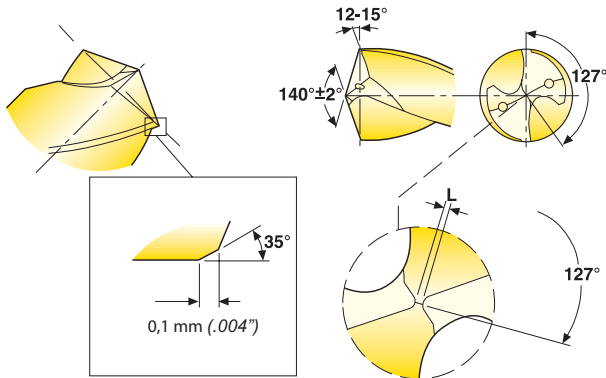

Bicie wzdłużne (bicie osiowe) powinno być w granicach 0,01 mm (0.0004")

2. Skracanie ścinu

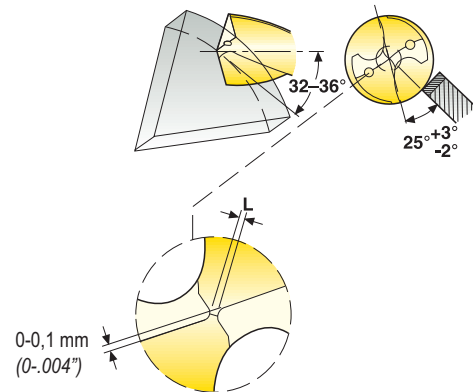

Wiertło Ø DC mm	L mm	Wiertło Ø DC cale	L cale
3-6	0,1-0,2	0.118-0.236	0.004-0.008
6-10	0,13-0,27	0.236-0.394	0.005-0.011
10-20	0,2-0,4	0.394-0.787	0.008-0.016

3. Szlifowanie spłaszczenia X

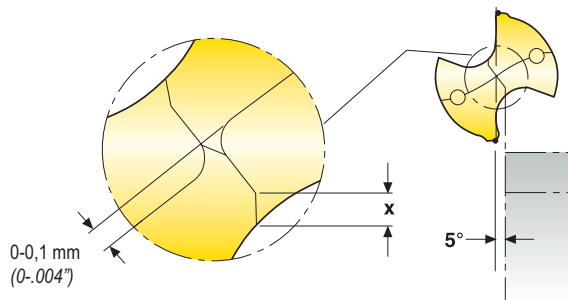

4. Zabezp. krawędzi

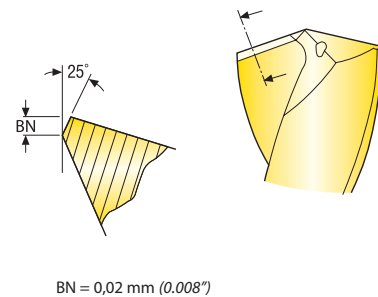

Maks. dopuszczalne zużycie powierzchni przyłożenia przed przeszlifowaniem to 0,1 - 0,3 mm (0.004-0.012") w największym punkcie.



SD1103 – Ø 3-20 mm / 0.118-0.787 cal

SMG	f										v _c
	Ø 3,00 Ø 0.118	Ø 4,00 Ø 0.157	Ø 6,00 Ø 0.236	Ø 8,00 Ø 0.315	Ø 10,00 Ø 0.394	Ø 12,00 Ø 0.472	Ø 14,00 Ø 0.551	Ø 16,00 Ø 0.630	Ø 18,00 Ø 0.709	Ø 20,00 Ø 0.787	
P1	0,12	0,14	0,18	0,22	0,25	0,28	0,30	0,32	0,34	0,36	105
	0.0048	0.0055	0.0070	0.0085	0.010	0.011	0.012	0.013	0.013	0.014	345
P2	0,12	0,14	0,18	0,22	0,26	0,28	0,32	0,34	0,36	0,36	105
	0.0048	0.0055	0.0070	0.0085	0.010	0.011	0.013	0.013	0.014	0.014	345
P3	0,11	0,13	0,17	0,20	0,24	0,28	0,30	0,32	0,34	0,34	90
	0.0044	0.0050	0.0065	0.0080	0.0095	0.011	0.012	0.013	0.013	0.013	295
P4	0,11	0,13	0,17	0,20	0,24	0,26	0,28	0,30	0,32	0,34	80
	0.0044	0.0050	0.0065	0.0080	0.0095	0.010	0.011	0.012	0.013	0.013	260
P5	0,11	0,13	0,16	0,20	0,24	0,26	0,28	0,30	0,32	0,34	75
	0.0044	0.0050	0.0065	0.0080	0.0095	0.010	0.011	0.012	0.013	0.013	245
P6	0,11	0,12	0,16	0,20	0,24	0,26	0,28	0,30	0,32	0,34	85
	0.0044	0.0048	0.0065	0.0080	0.0095	0.010	0.011	0.012	0.013	0.013	280
P7	0,11	0,12	0,16	0,20	0,24	0,26	0,28	0,30	0,32	0,34	80
	0.0044	0.0048	0.0065	0.0080	0.0095	0.010	0.011	0.012	0.013	0.013	260
P8	0,11	0,13	0,17	0,20	0,24	0,28	0,30	0,32	0,34	0,34	75
	0.0044	0.0050	0.0065	0.0080	0.0095	0.011	0.012	0.013	0.013	0.013	245
P11	0,11	0,12	0,16	0,20	0,24	0,26	0,28	0,30	0,32	0,34	75
	0.0044	0.0048	0.0065	0.0080	0.0095	0.010	0.011	0.012	0.013	0.013	245
P12	0,075	0,085	0,11	0,14	0,16	0,18	0,19	0,20	0,22	0,22	46
	0.0030	0.0034	0.0044	0.0055	0.0065	0.0070	0.0075	0.0080	0.0085	0.0085	150
M1	0,080	0,095	0,13	0,17	0,20	0,22	0,24	0,26	0,28	0,30	55
	0.0032	0.0038	0.0050	0.0065	0.0080	0.0085	0.0095	0.010	0.011	0.012	180
M2	0,070	0,085	0,12	0,15	0,18	0,20	0,22	0,24	0,25	0,26	45
	0.0028	0.0034	0.0048	0.0060	0.0070	0.0080	0.0085	0.0095	0.010	0.010	150
K1	0,12	0,14	0,18	0,22	0,26	0,28	0,30	0,34	0,34	0,36	70
	0.0048	0.0055	0.0070	0.0085	0.010	0.011	0.012	0.013	0.013	0.014	230
K2	0,11	0,13	0,16	0,20	0,24	0,26	0,28	0,30	0,32	0,34	60
	0.0044	0.0050	0.0065	0.0080	0.0095	0.010	0.011	0.012	0.013	0.013	195
K3	0,11	0,13	0,16	0,20	0,24	0,26	0,28	0,30	0,32	0,34	50
	0.0044	0.0050	0.0065	0.0080	0.0095	0.010	0.011	0.012	0.013	0.013	165
K4	0,11	0,13	0,16	0,20	0,24	0,26	0,28	0,30	0,32	0,34	49
	0.0044	0.0050	0.0065	0.0080	0.0095	0.010	0.011	0.012	0.013	0.013	160
K5	0,10	0,11	0,15	0,18	0,20	0,24	0,25	0,28	0,28	0,30	29
	0.0040	0.0044	0.0060	0.0070	0.0080	0.0095	0.010	0.011	0.011	0.012	95
H3	0,048	0,055	0,075	0,090	0,10	0,12	0,13	0,14	0,14	0,15	24
	0.0019	0.0022	0.0030	0.0036	0.0040	0.0048	0.0050	0.0055	0.0055	0.0060	80
H5	0,075	0,085	0,11	0,14	0,16	0,18	0,19	0,20	0,22	0,22	45
	0.0030	0.0034	0.0044	0.0055	0.0065	0.0070	0.0075	0.0080	0.0085	0.0085	150
H7	0,048	0,055	0,075	0,090	0,10	0,12	0,13	0,14	0,14	0,15	24
	0.0019	0.0022	0.0030	0.0036	0.0040	0.0048	0.0050	0.0055	0.0055	0.0060	80
H8	0,055	0,065	0,085	0,10	0,12	0,14	0,15	0,16	0,17	0,17	45
	0.0022	0.0026	0.0034	0.0040	0.0048	0.0055	0.0060	0.0065	0.0065	0.0065	150
H11	0,075	0,085	0,11	0,14	0,16	0,18	0,19	0,20	0,22	0,22	60
	0.0030	0.0034	0.0044	0.0055	0.0065	0.0070	0.0075	0.0080	0.0085	0.0085	195
H12	0,055	0,065	0,085	0,10	0,12	0,14	0,15	0,16	0,17	0,17	27
	0.0022	0.0026	0.0034	0.0040	0.0048	0.0055	0.0060	0.0065	0.0065	0.0065	90

SMG = Grupy materiałowe Seco f = mm/obr (cal/obr) v_c = m/min (stp/min) Wszystkie parametry są wartościami początkowymi

SD1103A – Ø 3-20 mm / 0.118-0.787 cal

SMG	f										v _c
	Ø 3,00 Ø 0.118	Ø 4,00 Ø 0.157	Ø 6,00 Ø 0.236	Ø 8,00 Ø 0.315	Ø 10,00 Ø 0.394	Ø 12,00 Ø 0.472	Ø 14,00 Ø 0.551	Ø 16,00 Ø 0.630	Ø 18,00 Ø 0.709	Ø 20,00 Ø 0.787	
P1	0,12	0,14	0,18	0,22	0,25	0,28	0,30	0,32	0,34	0,36	150
	0.0048	0.0055	0.0070	0.0085	0.010	0.011	0.012	0.013	0.013	0.014	490
P2	0,12	0,14	0,18	0,22	0,26	0,28	0,32	0,34	0,36	0,36	145
	0.0048	0.0055	0.0070	0.0085	0.010	0.011	0.013	0.013	0.014	0.014	475
P3	0,11	0,13	0,17	0,20	0,24	0,28	0,30	0,32	0,34	0,34	125
	0.0044	0.0050	0.0065	0.0080	0.0095	0.011	0.012	0.013	0.013	0.013	410
P4	0,11	0,13	0,17	0,20	0,24	0,26	0,28	0,30	0,32	0,34	110
	0.0044	0.0050	0.0065	0.0080	0.0095	0.010	0.011	0.012	0.013	0.013	360
P5	0,11	0,13	0,16	0,20	0,24	0,26	0,28	0,30	0,32	0,34	105
	0.0044	0.0050	0.0065	0.0080	0.0095	0.010	0.011	0.012	0.013	0.013	345
P6	0,11	0,12	0,16	0,20	0,24	0,26	0,28	0,30	0,32	0,34	120
	0.0044	0.0048	0.0065	0.0080	0.0095	0.010	0.011	0.012	0.013	0.013	395
P7	0,11	0,12	0,16	0,20	0,24	0,26	0,28	0,30	0,32	0,34	110
	0.0044	0.0048	0.0065	0.0080	0.0095	0.010	0.011	0.012	0.013	0.013	360
P8	0,11	0,13	0,17	0,20	0,24	0,28	0,30	0,32	0,34	0,34	105
	0.0044	0.0050	0.0065	0.0080	0.0095	0.011	0.012	0.013	0.013	0.013	345
P11	0,11	0,12	0,16	0,20	0,24	0,26	0,28	0,30	0,32	0,34	75
	0.0044	0.0048	0.0065	0.0080	0.0095	0.010	0.011	0.012	0.013	0.013	245
P12	0,075	0,085	0,11	0,14	0,16	0,18	0,19	0,20	0,22	0,22	50
	0.0030	0.0034	0.0044	0.0055	0.0065	0.0070	0.0075	0.0080	0.0085	0.0085	165
M1	0,080	0,095	0,13	0,17	0,20	0,22	0,24	0,26	0,28	0,30	80
	0.0032	0.0038	0.0050	0.0065	0.0080	0.0085	0.0095	0.010	0.011	0.012	260
M2	0,070	0,085	0,12	0,15	0,18	0,20	0,22	0,24	0,25	0,26	65
	0.0028	0.0034	0.0048	0.0060	0.0070	0.0080	0.0085	0.0095	0.010	0.010	215
M3	0,055	0,070	0,095	0,12	0,14	0,16	0,18	0,19	0,20	0,22	48
	0.0022	0.0028	0.0038	0.0048	0.0055	0.0065	0.0070	0.0075	0.0080	0.0085	155
M4	0,050	0,060	0,085	0,11	0,12	0,14	0,15	0,17	0,18	0,19	36
	0.0020	0.0024	0.0034	0.0044	0.0048	0.0055	0.0060	0.0065	0.0070	0.0075	120
M5	0,050	0,060	0,085	0,11	0,12	0,14	0,15	0,17	0,18	0,19	30
	0.0020	0.0024	0.0034	0.0044	0.0048	0.0055	0.0060	0.0065	0.0070	0.0075	100
K1	0,12	0,14	0,18	0,22	0,26	0,28	0,30	0,34	0,34	0,36	95
	0.0048	0.0055	0.0070	0.0085	0.010	0.011	0.012	0.013	0.013	0.014	310
K2	0,11	0,13	0,16	0,20	0,24	0,26	0,28	0,30	0,32	0,34	80
	0.0044	0.0050	0.0065	0.0080	0.0095	0.010	0.011	0.012	0.013	0.013	260
K3	0,11	0,13	0,16	0,20	0,24	0,26	0,28	0,30	0,32	0,34	70
	0.0044	0.0050	0.0065	0.0080	0.0095	0.010	0.011	0.012	0.013	0.013	230
K4	0,11	0,13	0,16	0,20	0,24	0,26	0,28	0,30	0,32	0,34	65
	0.0044	0.0050	0.0065	0.0080	0.0095	0.010	0.011	0.012	0.013	0.013	215
K5	0,10	0,11	0,15	0,18	0,20	0,24	0,25	0,28	0,28	0,30	39
	0.0040	0.0044	0.0060	0.0070	0.0080	0.0095	0.010	0.011	0.011	0.012	130
N1	0,15	0,17	0,22	0,25	0,28	0,32	0,34	0,36	0,38	0,40	260
	0.0060	0.0065	0.0085	0.010	0.011	0.013	0.013	0.014	0.015	0.016	850
N2	0,15	0,17	0,22	0,25	0,28	0,32	0,34	0,36	0,38	0,40	170
	0.0060	0.0065	0.0085	0.010	0.011	0.013	0.013	0.014	0.015	0.016	560
N3	0,15	0,17	0,22	0,25	0,28	0,32	0,34	0,36	0,38	0,40	110
	0.0060	0.0065	0.0085	0.010	0.011	0.013	0.013	0.014	0.015	0.016	360
N11	0,15	0,17	0,22	0,25	0,28	0,32	0,34	0,36	0,38	0,40	210
	0.0060	0.0065	0.0085	0.010	0.011	0.013	0.013	0.014	0.015	0.016	690
H3	0,048	0,055	0,075	0,090	0,10	0,12	0,13	0,14	0,14	0,15	34
	0.0019	0.0022	0.0030	0.0036	0.0040	0.0048	0.0050	0.0055	0.0055	0.0060	110
H5	0,075	0,085	0,11	0,14	0,16	0,18	0,19	0,20	0,22	0,22	65
	0.0030	0.0034	0.0044	0.0055	0.0065	0.0070	0.0075	0.0080	0.0085	0.0085	215
H7	0,048	0,055	0,075	0,090	0,10	0,12	0,13	0,14	0,14	0,15	34
	0.0019	0.0022	0.0030	0.0036	0.0040	0.0048	0.0050	0.0055	0.0055	0.0060	110
H8	0,055	0,065	0,085	0,10	0,12	0,14	0,15	0,16	0,17	0,17	65
	0.0022	0.0026	0.0034	0.0040	0.0048	0.0055	0.0060	0.0065	0.0065	0.0065	215
H11	0,075	0,085	0,11	0,14	0,16	0,18	0,19	0,20	0,22	0,22	80
	0.0030	0.0034	0.0044	0.0055	0.0065	0.0070	0.0075	0.0080	0.0085	0.0085	260
H12	0,055	0,065	0,085	0,10	0,12	0,14	0,15	0,16	0,17	0,17	38
	0.0022	0.0026	0.0034	0.0040	0.0048	0.0055	0.0060	0.0065	0.0065	0.0065	125

SMG = Grupy materiałowe Seco f = mm/obr (cal/obr) v_c = m/min (stp/min) Wszystkie parametry są wartościami początkowymi

Wstęp

Wiercenie

Rozwiercanie

Wyłaczanie

Załącznik

SD1105A – Ø 3-20 mm / 0.118-0.787 cal

SMG	f										v _c
	Ø 3,00 Ø 0.118	Ø 4,00 Ø 0.157	Ø 6,00 Ø 0.236	Ø 8,00 Ø 0.315	Ø 10,00 Ø 0.394	Ø 12,00 Ø 0.472	Ø 14,00 Ø 0.551	Ø 16,00 Ø 0.630	Ø 18,00 Ø 0.709	Ø 20,00 Ø 0.787	
P1	0,12	0,14	0,18	0,22	0,25	0,28	0,30	0,32	0,34	0,36	135
	0.0048	0.0055	0.0070	0.0085	0.010	0.011	0.012	0.013	0.013	0.014	445
P2	0,12	0,14	0,18	0,22	0,26	0,28	0,32	0,34	0,36	0,36	135
	0.0048	0.0055	0.0070	0.0085	0.010	0.011	0.013	0.013	0.014	0.014	445
P3	0,11	0,13	0,17	0,20	0,24	0,28	0,30	0,32	0,34	0,34	115
	0.0044	0.0050	0.0065	0.0080	0.0095	0.011	0.012	0.013	0.013	0.013	375
P4	0,11	0,13	0,17	0,20	0,24	0,26	0,28	0,30	0,32	0,34	100
	0.0044	0.0050	0.0065	0.0080	0.0095	0.010	0.011	0.012	0.013	0.013	330
P5	0,11	0,13	0,16	0,20	0,24	0,26	0,28	0,30	0,32	0,34	95
	0.0044	0.0050	0.0065	0.0080	0.0095	0.010	0.011	0.012	0.013	0.013	310
P6	0,11	0,12	0,16	0,20	0,24	0,26	0,28	0,30	0,32	0,34	110
	0.0044	0.0048	0.0065	0.0080	0.0095	0.010	0.011	0.012	0.013	0.013	360
P7	0,11	0,12	0,16	0,20	0,24	0,26	0,28	0,30	0,32	0,34	100
	0.0044	0.0048	0.0065	0.0080	0.0095	0.010	0.011	0.012	0.013	0.013	330
P8	0,11	0,13	0,17	0,20	0,24	0,28	0,30	0,32	0,34	0,34	95
	0.0044	0.0050	0.0065	0.0080	0.0095	0.011	0.012	0.013	0.013	0.013	310
P11	0,11	0,12	0,16	0,20	0,24	0,26	0,28	0,30	0,32	0,34	65
	0.0044	0.0048	0.0065	0.0080	0.0095	0.010	0.011	0.012	0.013	0.013	215
P12	0,075	0,085	0,11	0,14	0,16	0,18	0,19	0,20	0,22	0,22	48
	0.0030	0.0034	0.0044	0.0055	0.0065	0.0070	0.0075	0.0080	0.0085	0.0085	155
M1	0,080	0,095	0,13	0,17	0,20	0,22	0,24	0,26	0,28	0,30	70
	0.0032	0.0038	0.0050	0.0065	0.0080	0.0085	0.0095	0.010	0.011	0.012	230
M2	0,070	0,085	0,12	0,15	0,18	0,20	0,22	0,24	0,25	0,26	60
	0.0028	0.0034	0.0048	0.0060	0.0070	0.0080	0.0085	0.0095	0.010	0.010	195
M3	0,055	0,070	0,095	0,12	0,14	0,16	0,18	0,19	0,20	0,22	44
	0.0022	0.0028	0.0038	0.0048	0.0055	0.0065	0.0070	0.0075	0.0080	0.0085	145
M4	0,050	0,060	0,085	0,11	0,12	0,14	0,15	0,17	0,18	0,19	33
	0.0020	0.0024	0.0034	0.0044	0.0048	0.0055	0.0060	0.0065	0.0070	0.0075	110
M5	0,050	0,060	0,085	0,11	0,12	0,14	0,15	0,17	0,18	0,19	27
	0.0020	0.0024	0.0034	0.0044	0.0048	0.0055	0.0060	0.0065	0.0070	0.0075	90
K1	0,12	0,14	0,18	0,22	0,26	0,28	0,30	0,34	0,34	0,36	85
	0.0048	0.0055	0.0070	0.0085	0.010	0.011	0.012	0.013	0.013	0.014	280
K2	0,11	0,13	0,16	0,20	0,24	0,26	0,28	0,30	0,32	0,34	75
	0.0044	0.0050	0.0065	0.0080	0.0095	0.010	0.011	0.012	0.013	0.013	245
K3	0,11	0,13	0,16	0,20	0,24	0,26	0,28	0,30	0,32	0,34	65
	0.0044	0.0050	0.0065	0.0080	0.0095	0.010	0.011	0.012	0.013	0.013	215
K4	0,11	0,13	0,16	0,20	0,24	0,26	0,28	0,30	0,32	0,34	60
	0.0044	0.0050	0.0065	0.0080	0.0095	0.010	0.011	0.012	0.013	0.013	195
K5	0,10	0,11	0,15	0,18	0,20	0,24	0,25	0,28	0,28	0,30	36
	0.0040	0.0044	0.0060	0.0070	0.0080	0.0095	0.010	0.011	0.011	0.012	120
N1	0,15	0,17	0,22	0,25	0,28	0,32	0,34	0,36	0,38	0,40	240
	0.0060	0.0065	0.0085	0.010	0.011	0.013	0.013	0.014	0.015	0.016	790
N2	0,15	0,17	0,22	0,25	0,28	0,32	0,34	0,36	0,38	0,40	155
	0.0060	0.0065	0.0085	0.010	0.011	0.013	0.013	0.014	0.015	0.016	510
N3	0,15	0,17	0,22	0,25	0,28	0,32	0,34	0,36	0,38	0,40	100
	0.0060	0.0065	0.0085	0.010	0.011	0.013	0.013	0.014	0.015	0.016	330
N11	0,15	0,17	0,22	0,25	0,28	0,32	0,34	0,36	0,38	0,40	190
	0.0060	0.0065	0.0085	0.010	0.011	0.013	0.013	0.014	0.015	0.016	620
H3	0,048	0,055	0,075	0,090	0,10	0,12	0,13	0,14	0,14	0,15	31
	0.0019	0.0022	0.0030	0.0036	0.0040	0.0048	0.0050	0.0055	0.0055	0.0060	100
H5	0,075	0,085	0,11	0,14	0,16	0,18	0,19	0,20	0,22	0,22	60
	0.0030	0.0034	0.0044	0.0055	0.0065	0.0070	0.0075	0.0080	0.0085	0.0085	195
H7	0,048	0,055	0,075	0,090	0,10	0,12	0,13	0,14	0,14	0,15	31
	0.0019	0.0022	0.0030	0.0036	0.0040	0.0048	0.0050	0.0055	0.0055	0.0060	100
H8	0,055	0,065	0,085	0,10	0,12	0,14	0,15	0,16	0,17	0,17	60
	0.0022	0.0026	0.0034	0.0040	0.0048	0.0055	0.0060	0.0065	0.0065	0.0065	195
H11	0,075	0,085	0,11	0,14	0,16	0,18	0,19	0,20	0,22	0,22	75
	0.0030	0.0034	0.0044	0.0055	0.0065	0.0070	0.0075	0.0080	0.0085	0.0085	245
H12	0,055	0,065	0,085	0,10	0,12	0,14	0,15	0,16	0,17	0,17	35
	0.0022	0.0026	0.0034	0.0040	0.0048	0.0055	0.0060	0.0065	0.0065	0.0065	115

 SMG = Grupy materiałowe Seco f = mm/obr (cal/obr) v_c = m/min (stp/min) Wszystkie parametry są wartościami początkowymi

Wstęp

Wiercenie

Rozwiercanie

Wyłaczanie

Załącznik

SD1108A – Ø 3-20 mm / 0.118-0.787 cala

SMG	f										v _c
	Ø 3,00 Ø 0.118	Ø 4,00 Ø 0.157	Ø 6,00 Ø 0.236	Ø 8,00 Ø 0.315	Ø 10,00 Ø 0.394	Ø 12,00 Ø 0.472	Ø 14,00 Ø 0.551	Ø 16,00 Ø 0.630	Ø 18,00 Ø 0.709	Ø 20,00 Ø 0.787	
P1	0,12	0,14	0,18	0,22	0,25	0,28	0,30	0,32	0,34	0,36	120
	0.0048	0.0055	0.0070	0.0085	0.010	0.011	0.012	0.013	0.013	0.014	395
P2	0,12	0,14	0,18	0,22	0,26	0,28	0,32	0,34	0,36	0,36	115
	0.0048	0.0055	0.0070	0.0085	0.010	0.011	0.013	0.013	0.014	0.014	375
P3	0,11	0,13	0,17	0,20	0,24	0,28	0,30	0,32	0,34	0,34	100
	0.0044	0.0050	0.0065	0.0080	0.0095	0.011	0.012	0.013	0.013	0.013	330
P4	0,11	0,13	0,17	0,20	0,24	0,26	0,28	0,30	0,32	0,34	85
	0.0044	0.0050	0.0065	0.0080	0.0095	0.010	0.011	0.012	0.013	0.013	280
P5	0,11	0,13	0,16	0,20	0,24	0,26	0,28	0,30	0,32	0,34	85
	0.0044	0.0050	0.0065	0.0080	0.0095	0.010	0.011	0.012	0.013	0.013	280
P6	0,11	0,12	0,16	0,20	0,24	0,26	0,28	0,30	0,32	0,34	95
	0.0044	0.0048	0.0065	0.0080	0.0095	0.010	0.011	0.012	0.013	0.013	310
P7	0,11	0,12	0,16	0,20	0,24	0,26	0,28	0,30	0,32	0,34	90
	0.0044	0.0048	0.0065	0.0080	0.0095	0.010	0.011	0.012	0.013	0.013	295
P8	0,11	0,13	0,17	0,20	0,24	0,28	0,30	0,32	0,34	0,34	85
	0.0044	0.0050	0.0065	0.0080	0.0095	0.011	0.012	0.013	0.013	0.013	280
P11	0,11	0,12	0,16	0,20	0,24	0,26	0,28	0,30	0,32	0,34	60
	0.0044	0.0048	0.0065	0.0080	0.0095	0.010	0.011	0.012	0.013	0.013	195
P12	0,075	0,085	0,11	0,14	0,16	0,18	0,19	0,20	0,22	0,22	42
	0.0030	0.0034	0.0044	0.0055	0.0065	0.0070	0.0075	0.0080	0.0085	0.0085	140
M1	0,080	0,095	0,13	0,17	0,20	0,22	0,24	0,26	0,28	0,30	60
	0.0032	0.0038	0.0050	0.0065	0.0080	0.0085	0.0095	0.010	0.011	0.012	195
M2	0,070	0,085	0,12	0,15	0,18	0,20	0,22	0,24	0,25	0,26	50
	0.0028	0.0034	0.0048	0.0060	0.0070	0.0080	0.0085	0.0095	0.010	0.010	165
M3	0,055	0,070	0,095	0,12	0,14	0,16	0,18	0,19	0,20	0,22	38
	0.0022	0.0028	0.0038	0.0048	0.0055	0.0065	0.0070	0.0075	0.0080	0.0085	125
M4	0,050	0,060	0,085	0,11	0,12	0,14	0,15	0,17	0,18	0,19	29
	0.0020	0.0024	0.0034	0.0044	0.0048	0.0055	0.0060	0.0065	0.0070	0.0075	95
M5	0,050	0,060	0,085	0,11	0,12	0,14	0,15	0,17	0,18	0,19	24
	0.0020	0.0024	0.0034	0.0044	0.0048	0.0055	0.0060	0.0065	0.0070	0.0075	80
K1	0,12	0,14	0,18	0,22	0,26	0,28	0,30	0,34	0,34	0,36	75
	0.0048	0.0055	0.0070	0.0085	0.010	0.011	0.012	0.013	0.013	0.014	245
K2	0,11	0,13	0,16	0,20	0,24	0,26	0,28	0,30	0,32	0,34	65
	0.0044	0.0050	0.0065	0.0080	0.0095	0.010	0.011	0.012	0.013	0.013	215
K3	0,11	0,13	0,16	0,20	0,24	0,26	0,28	0,30	0,32	0,34	55
	0.0044	0.0050	0.0065	0.0080	0.0095	0.010	0.011	0.012	0.013	0.013	180
K4	0,11	0,13	0,16	0,20	0,24	0,26	0,28	0,30	0,32	0,34	50
	0.0044	0.0050	0.0065	0.0080	0.0095	0.010	0.011	0.012	0.013	0.013	165
K5	0,10	0,11	0,15	0,18	0,20	0,24	0,25	0,28	0,28	0,30	31
	0.0040	0.0044	0.0060	0.0070	0.0080	0.0095	0.010	0.011	0.011	0.012	100
N1	0,15	0,17	0,22	0,25	0,28	0,32	0,34	0,36	0,38	0,40	205
	0.0060	0.0065	0.0085	0.010	0.011	0.013	0.013	0.014	0.015	0.016	670
N2	0,15	0,17	0,22	0,25	0,28	0,32	0,34	0,36	0,38	0,40	135
	0.0060	0.0065	0.0085	0.010	0.011	0.013	0.013	0.014	0.015	0.016	445
N3	0,15	0,17	0,22	0,25	0,28	0,32	0,34	0,36	0,38	0,40	90
	0.0060	0.0065	0.0085	0.010	0.011	0.013	0.013	0.014	0.015	0.016	295
N11	0,15	0,17	0,22	0,25	0,28	0,32	0,34	0,36	0,38	0,40	165
	0.0060	0.0065	0.0085	0.010	0.011	0.013	0.013	0.014	0.015	0.016	540
H3	0,048	0,055	0,075	0,090	0,10	0,12	0,13	0,14	0,14	0,15	27
	0.0019	0.0022	0.0030	0.0036	0.0040	0.0048	0.0050	0.0055	0.0055	0.0060	90
H5	0,075	0,085	0,11	0,14	0,16	0,18	0,19	0,20	0,22	0,22	50
	0.0030	0.0034	0.0044	0.0055	0.0065	0.0070	0.0075	0.0080	0.0085	0.0085	165
H7	0,048	0,055	0,075	0,090	0,10	0,12	0,13	0,14	0,14	0,15	27
	0.0019	0.0022	0.0030	0.0036	0.0040	0.0048	0.0050	0.0055	0.0055	0.0060	90
H8	0,055	0,065	0,085	0,10	0,12	0,14	0,15	0,16	0,17	0,17	50
	0.0022	0.0026	0.0034	0.0040	0.0048	0.0055	0.0060	0.0065	0.0065	0.0065	165
H11	0,075	0,085	0,11	0,14	0,16	0,18	0,19	0,20	0,22	0,22	65
	0.0030	0.0034	0.0044	0.0055	0.0065	0.0070	0.0075	0.0080	0.0085	0.0085	215
H12	0,055	0,065	0,085	0,10	0,12	0,14	0,15	0,16	0,17	0,17	30
	0.0022	0.0026	0.0034	0.0040	0.0048	0.0055	0.0060	0.0065	0.0065	0.0065	100

SMG = Grupy materiałowe Seco f = mm/obr (cal/obr) v_c = m/min (stp/min) Wszystkie parametry są wartościami początkowymi

Podczas wiercenia w stali nierdzewnej przy głębokości 8xD i 12xD może być konieczne przeprowadzenie wstępnego wiercenia

SD1112A – Ø 3-20 mm / 0.118-0.787 cal

SMG	f										v _c
	Ø 3,00 Ø 0.118	Ø 4,00 Ø 0.157	Ø 6,00 Ø 0.236	Ø 8,00 Ø 0.315	Ø 10,00 Ø 0.394	Ø 12,00 Ø 0.472	Ø 14,00 Ø 0.551	Ø 16,00 Ø 0.630	Ø 18,00 Ø 0.709	Ø 20,00 Ø 0.787	
P1	0,12	0,14	0,18	0,22	0,25	0,28	0,30	0,32	0,34	0,36	100
	0.0048	0.0055	0.0070	0.0085	0.010	0.011	0.012	0.013	0.013	0.014	330
P2	0,12	0,14	0,18	0,22	0,26	0,28	0,32	0,34	0,36	0,36	100
	0.0048	0.0055	0.0070	0.0085	0.010	0.011	0.013	0.013	0.014	0.014	330
P3	0,11	0,13	0,17	0,20	0,24	0,28	0,30	0,32	0,34	0,34	85
	0.0044	0.0050	0.0065	0.0080	0.0095	0.011	0.012	0.013	0.013	0.013	280
P4	0,11	0,13	0,17	0,20	0,24	0,26	0,28	0,30	0,32	0,34	75
	0.0044	0.0050	0.0065	0.0080	0.0095	0.010	0.011	0.012	0.013	0.013	245
P5	0,11	0,13	0,16	0,20	0,24	0,26	0,28	0,30	0,32	0,34	70
	0.0044	0.0050	0.0065	0.0080	0.0095	0.010	0.011	0.012	0.013	0.013	230
P6	0,11	0,12	0,16	0,20	0,24	0,26	0,28	0,30	0,32	0,34	80
	0.0044	0.0048	0.0065	0.0080	0.0095	0.010	0.011	0.012	0.013	0.013	260
P7	0,11	0,12	0,16	0,20	0,24	0,26	0,28	0,30	0,32	0,34	75
	0.0044	0.0048	0.0065	0.0080	0.0095	0.010	0.011	0.012	0.013	0.013	245
P8	0,11	0,13	0,17	0,20	0,24	0,28	0,30	0,32	0,34	0,34	70
	0.0044	0.0050	0.0065	0.0080	0.0095	0.011	0.012	0.013	0.013	0.013	230
P11	0,11	0,12	0,16	0,20	0,24	0,26	0,28	0,30	0,32	0,34	50
	0.0044	0.0048	0.0065	0.0080	0.0095	0.010	0.011	0.012	0.013	0.013	165
P12	0,075	0,085	0,11	0,14	0,16	0,18	0,19	0,20	0,22	0,22	36
	0.0030	0.0034	0.0044	0.0055	0.0065	0.0070	0.0075	0.0080	0.0085	0.0085	120
M1	0,080	0,095	0,13	0,17	0,20	0,22	0,24	0,26	0,28	0,30	55
	0.0032	0.0038	0.0050	0.0065	0.0080	0.0085	0.0095	0.010	0.011	0.012	180
M2	0,070	0,085	0,12	0,15	0,18	0,20	0,22	0,24	0,25	0,26	43
	0.0028	0.0034	0.0048	0.0060	0.0070	0.0080	0.0085	0.0095	0.010	0.010	140
M3	0,055	0,070	0,095	0,12	0,14	0,16	0,18	0,19	0,20	0,22	33
	0.0022	0.0028	0.0038	0.0048	0.0055	0.0065	0.0070	0.0075	0.0080	0.0085	110
M4	0,050	0,060	0,085	0,11	0,12	0,14	0,15	0,17	0,18	0,19	25
	0.0020	0.0024	0.0034	0.0044	0.0048	0.0055	0.0060	0.0065	0.0070	0.0075	80
M5	0,050	0,060	0,085	0,11	0,12	0,14	0,15	0,17	0,18	0,19	21
	0.0020	0.0024	0.0034	0.0044	0.0048	0.0055	0.0060	0.0065	0.0070	0.0075	70
K1	0,12	0,14	0,18	0,22	0,26	0,28	0,30	0,34	0,34	0,36	65
	0.0048	0.0055	0.0070	0.0085	0.010	0.011	0.012	0.013	0.013	0.014	215
K2	0,11	0,13	0,16	0,20	0,24	0,26	0,28	0,30	0,32	0,34	55
	0.0044	0.0050	0.0065	0.0080	0.0095	0.010	0.011	0.012	0.013	0.013	180
K3	0,11	0,13	0,16	0,20	0,24	0,26	0,28	0,30	0,32	0,34	47
	0.0044	0.0050	0.0065	0.0080	0.0095	0.010	0.011	0.012	0.013	0.013	155
K4	0,11	0,13	0,16	0,20	0,24	0,26	0,28	0,30	0,32	0,34	45
	0.0044	0.0050	0.0065	0.0080	0.0095	0.010	0.011	0.012	0.013	0.013	150
K5	0,10	0,11	0,15	0,18	0,20	0,24	0,25	0,28	0,28	0,30	27
	0.0040	0.0044	0.0060	0.0070	0.0080	0.0095	0.010	0.011	0.011	0.012	90
N1	0,15	0,17	0,22	0,25	0,28	0,32	0,34	0,36	0,38	0,40	180
	0.0060	0.0065	0.0085	0.010	0.011	0.013	0.013	0.014	0.015	0.016	590
N2	0,15	0,17	0,22	0,25	0,28	0,32	0,34	0,36	0,38	0,40	115
	0.0060	0.0065	0.0085	0.010	0.011	0.013	0.013	0.014	0.015	0.016	375
N3	0,15	0,17	0,22	0,25	0,28	0,32	0,34	0,36	0,38	0,40	75
	0.0060	0.0065	0.0085	0.010	0.011	0.013	0.013	0.014	0.015	0.016	245
N11	0,15	0,17	0,22	0,25	0,28	0,32	0,34	0,36	0,38	0,40	145
	0.0060	0.0065	0.0085	0.010	0.011	0.013	0.013	0.014	0.015	0.016	475
H3	0,048	0,055	0,075	0,090	0,10	0,12	0,13	0,14	0,14	0,15	23
	0.0019	0.0022	0.0030	0.0036	0.0040	0.0048	0.0050	0.0055	0.0055	0.0060	75
H5	0,075	0,085	0,11	0,14	0,16	0,18	0,19	0,20	0,22	0,22	43
	0.0030	0.0034	0.0044	0.0055	0.0065	0.0070	0.0075	0.0080	0.0085	0.0085	140
H7	0,048	0,055	0,075	0,090	0,10	0,12	0,13	0,14	0,14	0,15	23
	0.0019	0.0022	0.0030	0.0036	0.0040	0.0048	0.0050	0.0055	0.0055	0.0060	75
H8	0,055	0,065	0,085	0,10	0,12	0,14	0,15	0,16	0,17	0,17	43
	0.0022	0.0026	0.0034	0.0040	0.0048	0.0055	0.0060	0.0065	0.0065	0.0065	140
H11	0,075	0,085	0,11	0,14	0,16	0,18	0,19	0,20	0,22	0,22	55
	0.0030	0.0034	0.0044	0.0055	0.0065	0.0070	0.0075	0.0080	0.0085	0.0085	180
H12	0,055	0,065	0,085	0,10	0,12	0,14	0,15	0,16	0,17	0,17	26
	0.0022	0.0026	0.0034	0.0040	0.0048	0.0055	0.0060	0.0065	0.0065	0.0065	85

SMG = Grupy materiałowe Seco f = mm/obr (cal/obr) v_c = m/min (stp/min) Wszystkie parametry są wartościami początkowymi

Podczas wiercenia w stali nierdzewnej przy głębokości 8xD i 12xD może być konieczne przeprowadzenie wstępnego wiercenia

Wstęp

Wiercenie

Rozwiercanie

Wylaczanie

Zalacznik

SD203A – Ø 2-8 mm / 0.079-0.315 cal

SMG		f						V _c
		Ø 2,00 Ø 0.079	Ø 3,00 Ø 0.118	Ø 4,00 Ø 0.157	Ø 5,00 Ø 0.197	Ø 6,00 Ø 0.236	Ø 8,00 Ø 0.315	
P1	P	0,14	0,17	0,20	0,24	0,26	0,32	185
	P	0.0055	0.0065	0.0080	0.0095	0.010	0.013	610
P2	P	0,14	0,17	0,20	0,24	0,26	0,32	180
	P	0.0055	0.0065	0.0080	0.0095	0.010	0.013	590
P3	P	0,14	0,16	0,19	0,22	0,25	0,32	155
	P	0.0055	0.0065	0.0075	0.0085	0.010	0.013	510
P4	P	0,10	0,13	0,15	0,17	0,19	0,24	210
	P	0.0040	0.0050	0.0060	0.0065	0.0075	0.0095	690
P5	P	0,10	0,12	0,14	0,17	0,19	0,22	205
	P	0.0040	0.0048	0.0055	0.0065	0.0075	0.0085	670
P6	P	0,10	0,12	0,14	0,16	0,19	0,22	230
	P	0.0040	0.0048	0.0055	0.0065	0.0075	0.0085	750
P7	P	0,10	0,12	0,14	0,16	0,19	0,22	215
	P	0.0040	0.0048	0.0055	0.0065	0.0075	0.0085	710
P8	P	0,11	0,13	0,15	0,17	0,19	0,24	200
	P	0.0044	0.0050	0.0060	0.0065	0.0075	0.0095	660
P11	P	0,060	0,075	0,085	0,10	0,11	0,14	105
	P	0.0024	0.0030	0.0034	0.0040	0.0044	0.0055	345
P12	P	0,060	0,075	0,085	0,10	0,11	0,14	75
	P	0.0024	0.0030	0.0034	0.0040	0.0044	0.0055	245
M1	MS	0,075	0,095	0,11	0,13	0,15	0,19	110
	MS	0.0030	0.0038	0.0044	0.0050	0.0060	0.0075	360
M2	MS	0,065	0,085	0,10	0,12	0,14	0,17	90
	MS	0.0026	0.0034	0.0040	0.0048	0.0055	0.0065	295
M3	MS	0,095	0,11	0,13	0,15	0,17	0,20	45
	MS	0.0038	0.0044	0.0050	0.0060	0.0065	0.0080	150
M4	MS	0,048	0,060	0,070	0,085	0,095	0,12	50
	MS	0.0019	0.0024	0.0028	0.0034	0.0038	0.0048	165
M5	MS	0,048	0,060	0,070	0,085	0,095	0,12	42
	MS	0.0019	0.0024	0.0028	0.0034	0.0038	0.0048	140
K1	P	0,15	0,18	0,22	0,25	0,28	0,36	175
	P	0.0060	0.0070	0.0085	0.010	0.011	0.014	570
K2	P	0,14	0,17	0,20	0,22	0,26	0,32	150
	P	0.0055	0.0065	0.0080	0.0085	0.010	0.013	490
K3	P	0,14	0,17	0,20	0,22	0,26	0,32	125
	P	0.0055	0.0065	0.0080	0.0085	0.010	0.013	410
K4	P	0,14	0,17	0,20	0,22	0,26	0,32	120
	P	0.0055	0.0065	0.0080	0.0085	0.010	0.013	395
K5	P	0,12	0,15	0,18	0,20	0,24	0,28	70
	P	0.0048	0.0060	0.0070	0.0080	0.0095	0.011	230
N1	N	0,13	0,16	0,19	0,22	0,26	0,32	350
	N	0.0050	0.0065	0.0075	0.0085	0.010	0.013	1150
N2	MS	0,13	0,16	0,19	0,22	0,26	0,32	225
	MS	0.0050	0.0065	0.0075	0.0085	0.010	0.013	740
N3	MS	0,13	0,16	0,19	0,22	0,26	0,32	150
	MS	0.0050	0.0065	0.0075	0.0085	0.010	0.013	490
N11	MS	0,13	0,16	0,19	0,22	0,26	0,32	285
	MS	0.0050	0.0065	0.0075	0.0085	0.010	0.013	940
S1	MS	0,040	0,048	0,055	0,065	0,075	0,095	39
	MS	0.0016	0.0019	0.0022	0.0026	0.0030	0.0038	130
S2	MS	0,040	0,048	0,055	0,065	0,075	0,095	28
	MS	0.0016	0.0019	0.0022	0.0026	0.0030	0.0038	90
S3	MS	0,040	0,048	0,055	0,065	0,075	0,095	28
	MS	0.0016	0.0019	0.0022	0.0026	0.0030	0.0038	90
S11	MS	0,070	0,085	0,095	0,11	0,12	0,14	70
	MS	0.0028	0.0034	0.0038	0.0044	0.0048	0.0055	230
S12	MS	0,070	0,085	0,095	0,11	0,12	0,14	55
	MS	0.0028	0.0034	0.0038	0.0044	0.0048	0.0055	180
S13	MS	0,065	0,075	0,085	0,095	0,10	0,12	43
	MS	0.0026	0.0030	0.0034	0.0038	0.0040	0.0048	140
H3	P	0,055	0,070	0,080	0,090	0,10	0,12	28
	P	0.0022	0.0028	0.0032	0.0036	0.0040	0.0048	90
H5	P	0,085	0,10	0,12	0,13	0,15	0,18	55
	P	0.0034	0.0040	0.0048	0.0050	0.0060	0.0070	180
H7	P	0,055	0,070	0,080	0,090	0,10	0,12	28
	P	0.0022	0.0028	0.0032	0.0036	0.0040	0.0048	90
H8	P	0,065	0,080	0,090	0,10	0,12	0,14	55
	P	0.0026	0.0032	0.0036	0.0040	0.0048	0.0055	180
H11	P	0,085	0,10	0,12	0,13	0,15	0,18	65
	P	0.0034	0.0040	0.0048	0.0050	0.0060	0.0070	215
H12	P	0,065	0,080	0,090	0,10	0,12	0,14	80
	P	0.0026	0.0032	0.0036	0.0040	0.0048	0.0055	260
H21	P	0,065	0,080	0,090	0,10	0,12	0,14	55
	P	0.0026	0.0032	0.0036	0.0040	0.0048	0.0055	180

SMG = Grupy materiałowe Seco f = mm/obr (cal/obr) v_c= m/min (stp/min) Wszystkie parametry są wartościami początkowymi

SD203A – Ø 10-20 mm / 0.394-0.787 cal

SMG		f						v _c
		Ø 10,00 Ø 0.394	Ø 12,00 Ø 0.472	Ø 14,00 Ø 0.551	Ø 16,00 Ø 0.630	Ø 18,00 Ø 0.709	Ø 20,00 Ø 0.787	
P1	P	0,38	0,44	0,48	0,50	0,55	0,55	185
	P	0,015	0,017	0,019	0,020	0,022	0,022	610
P2	P	0,38	0,44	0,48	0,50	0,55	0,60	180
	P	0,015	0,017	0,019	0,020	0,022	0,024	590
P3	P	0,36	0,42	0,46	0,50	0,50	0,55	155
	P	0,014	0,017	0,018	0,020	0,020	0,022	510
P4	P	0,28	0,30	0,34	0,36	0,38	0,40	210
	P	0,011	0,012	0,013	0,014	0,015	0,016	690
P5	P	0,26	0,30	0,32	0,34	0,36	0,38	205
	P	0,010	0,012	0,013	0,013	0,014	0,015	670
P6	P	0,26	0,30	0,32	0,34	0,36	0,38	230
	P	0,010	0,012	0,013	0,013	0,014	0,015	750
P7	P	0,26	0,30	0,32	0,34	0,36	0,38	215
	P	0,010	0,012	0,013	0,013	0,014	0,015	710
P8	P	0,28	0,32	0,34	0,36	0,38	0,40	200
	P	0,011	0,013	0,013	0,014	0,015	0,016	660
P11	P	0,16	0,18	0,20	0,22	0,24	0,24	105
	P	0,0065	0,0070	0,0080	0,0085	0,0095	0,0095	345
P12	P	0,16	0,18	0,20	0,22	0,24	0,24	75
	P	0,0065	0,0070	0,0080	0,0085	0,0095	0,0095	245
M1	MS	0,22	0,25	0,28	0,30	0,30	0,32	110
	MS	0,0085	0,010	0,011	0,012	0,012	0,013	360
M2	MS	0,20	0,22	0,25	0,26	0,28	0,30	90
	MS	0,0080	0,0085	0,010	0,010	0,011	0,012	295
M3	MS	0,24	0,26	0,28	0,30	0,32	0,34	45
	MS	0,0095	0,010	0,011	0,012	0,013	0,013	150
M4	MS	0,14	0,16	0,17	0,19	0,20	0,20	50
	MS	0,0055	0,0065	0,0065	0,0075	0,0080	0,0080	165
M5	MS	0,14	0,16	0,17	0,19	0,20	0,20	42
	MS	0,0055	0,0065	0,0065	0,0075	0,0080	0,0080	140
K1	P	0,42	0,48	0,50	0,55	0,60	0,65	175
	P	0,017	0,019	0,020	0,022	0,024	0,026	570
K2	P	0,38	0,42	0,48	0,50	0,55	0,55	150
	P	0,015	0,017	0,019	0,020	0,022	0,022	490
K3	P	0,38	0,42	0,48	0,50	0,55	0,55	125
	P	0,015	0,017	0,019	0,020	0,022	0,022	410
K4	P	0,38	0,42	0,48	0,50	0,55	0,55	120
	P	0,015	0,017	0,019	0,020	0,022	0,022	395
K5	P	0,34	0,38	0,42	0,46	0,48	0,50	70
	P	0,013	0,015	0,017	0,018	0,019	0,020	230
N1	N	0,38	0,42	0,46	0,50	0,55	0,55	350
	N	0,015	0,017	0,018	0,020	0,022	0,022	1150
N2	MS	0,38	0,42	0,46	0,50	0,55	0,55	225
	MS	0,015	0,017	0,018	0,020	0,022	0,022	740
N3	MS	0,38	0,42	0,46	0,50	0,55	0,55	150
	MS	0,015	0,017	0,018	0,020	0,022	0,022	490
N11	MS	0,38	0,42	0,46	0,50	0,55	0,55	285
	MS	0,015	0,017	0,018	0,020	0,022	0,022	940
S1	MS	0,11	0,13	0,15	0,16	0,17	0,19	39
	MS	0,0044	0,0050	0,0060	0,0065	0,0065	0,0075	130
S2	MS	0,11	0,13	0,15	0,16	0,17	0,19	28
	MS	0,0044	0,0050	0,0060	0,0065	0,0065	0,0075	90
S3	MS	0,11	0,13	0,15	0,16	0,17	0,19	28
	MS	0,0044	0,0050	0,0060	0,0065	0,0065	0,0075	90
S11	MS	0,17	0,19	0,22	0,24	0,25	0,26	70
	MS	0,0065	0,0075	0,0085	0,0095	0,010	0,010	230
S12	MS	0,17	0,19	0,22	0,24	0,25	0,26	55
	MS	0,0065	0,0075	0,0085	0,0095	0,010	0,010	180
S13	MS	0,15	0,17	0,19	0,20	0,22	0,22	43
	MS	0,0060	0,0065	0,0075	0,0080	0,0085	0,0085	140
H3	P	0,14	0,16	0,18	0,19	0,20	0,20	28
	P	0,0055	0,0065	0,0070	0,0075	0,0080	0,0080	90
H5	P	0,22	0,24	0,26	0,28	0,30	0,32	55
	P	0,0085	0,0095	0,010	0,011	0,012	0,013	180
H7	P	0,14	0,16	0,18	0,19	0,20	0,20	28
	P	0,0055	0,0065	0,0070	0,0075	0,0080	0,0080	90
H8	P	0,16	0,19	0,20	0,22	0,24	0,24	55
	P	0,0065	0,0075	0,0080	0,0085	0,0095	0,0095	180
H11	P	0,22	0,24	0,26	0,28	0,30	0,32	65
	P	0,0085	0,0095	0,010	0,011	0,012	0,013	215
H12	P	0,16	0,19	0,20	0,22	0,24	0,24	80
	P	0,0065	0,0075	0,0080	0,0085	0,0095	0,0095	260
H21	P	0,16	0,19	0,20	0,22	0,24	0,24	55
	P	0,0065	0,0075	0,0080	0,0085	0,0095	0,0095	180

SMG = Grupy materiałowe Seco f = mm/obr (cal/obr) v_c = m/min (stp/min) Wszystkie parametry są wartościami początkowymi

Wstęp

Wiercenie

Rozwiercanie

Wyłaczanie

Załącznik

SD205A – Ø 2-8 mm / 0.079-0.315 cal

SMG		f						V _c
		Ø 2,00 Ø 0.079	Ø 3,00 Ø 0.118	Ø 4,00 Ø 0.157	Ø 5,00 Ø 0.197	Ø 6,00 Ø 0.236	Ø 8,00 Ø 0.315	
P1	P	0,14	0,17	0,20	0,24	0,26	0,32	170
	P	0.0055	0.0065	0.0080	0.0095	0.010	0.013	560
P2	P	0,14	0,17	0,20	0,24	0,26	0,32	165
	P	0.0055	0.0065	0.0080	0.0095	0.010	0.013	540
P3	P	0,14	0,16	0,19	0,22	0,25	0,32	140
	P	0.0055	0.0065	0.0075	0.0085	0.010	0.013	460
P4	P	0,10	0,13	0,15	0,17	0,19	0,24	195
	P	0.0040	0.0050	0.0060	0.0065	0.0075	0.0095	640
P5	P	0,10	0,12	0,14	0,17	0,19	0,22	185
	P	0.0040	0.0048	0.0055	0.0065	0.0075	0.0085	610
P6	P	0,10	0,12	0,14	0,16	0,19	0,22	210
	P	0.0040	0.0048	0.0055	0.0065	0.0075	0.0085	690
P7	P	0,10	0,12	0,14	0,16	0,19	0,22	200
	P	0.0040	0.0048	0.0055	0.0065	0.0075	0.0085	660
P8	P	0,11	0,13	0,15	0,17	0,19	0,24	185
	P	0.0044	0.0050	0.0060	0.0065	0.0075	0.0095	610
P11	P	0,060	0,075	0,085	0,10	0,11	0,14	95
	P	0.0024	0.0030	0.0034	0.0040	0.0044	0.0055	310
P12	P	0,060	0,075	0,085	0,10	0,11	0,14	65
	P	0.0024	0.0030	0.0034	0.0040	0.0044	0.0055	215
M1	MS	0,075	0,095	0,11	0,13	0,15	0,19	110
	MS	0.0030	0.0038	0.0044	0.0050	0.0060	0.0075	360
M2	MS	0,065	0,085	0,10	0,12	0,14	0,17	90
	MS	0.0026	0.0034	0.0040	0.0048	0.0055	0.0065	295
M3	MS	0,095	0,11	0,13	0,15	0,17	0,20	45
	MS	0.0038	0.0044	0.0050	0.0060	0.0065	0.0080	150
M4	MS	0,048	0,060	0,070	0,085	0,095	0,12	50
	MS	0.0019	0.0024	0.0028	0.0034	0.0038	0.0048	165
M5	MS	0,048	0,060	0,070	0,085	0,095	0,12	42
	MS	0.0019	0.0024	0.0028	0.0034	0.0038	0.0048	140
K1	P	0,15	0,18	0,22	0,25	0,28	0,36	160
	P	0.0060	0.0070	0.0085	0.010	0.011	0.014	520
K2	P	0,14	0,17	0,20	0,22	0,26	0,32	135
	P	0.0055	0.0065	0.0080	0.0085	0.010	0.013	445
K3	P	0,14	0,17	0,20	0,22	0,26	0,32	115
	P	0.0055	0.0065	0.0080	0.0085	0.010	0.013	375
K4	P	0,14	0,17	0,20	0,22	0,26	0,32	110
	P	0.0055	0.0065	0.0080	0.0085	0.010	0.013	360
K5	P	0,12	0,15	0,18	0,20	0,24	0,28	65
	P	0.0048	0.0060	0.0070	0.0080	0.0095	0.011	215
N1	N	0,13	0,16	0,19	0,22	0,26	0,32	350
	N	0.0050	0.0065	0.0075	0.0085	0.010	0.013	1150
N2	MS	0,13	0,16	0,19	0,22	0,26	0,32	225
	MS	0.0050	0.0065	0.0075	0.0085	0.010	0.013	740
N3	MS	0,13	0,16	0,19	0,22	0,26	0,32	150
	MS	0.0050	0.0065	0.0075	0.0085	0.010	0.013	490
N11	MS	0,13	0,16	0,19	0,22	0,26	0,32	285
	MS	0.0050	0.0065	0.0075	0.0085	0.010	0.013	940
S1	MS	0,040	0,048	0,055	0,065	0,075	0,095	39
	MS	0.0016	0.0019	0.0022	0.0026	0.0030	0.0038	130
S2	MS	0,040	0,048	0,055	0,065	0,075	0,095	28
	MS	0.0016	0.0019	0.0022	0.0026	0.0030	0.0038	90
S3	MS	0,040	0,048	0,055	0,065	0,075	0,095	28
	MS	0.0016	0.0019	0.0022	0.0026	0.0030	0.0038	90
S11	MS	0,070	0,085	0,095	0,11	0,12	0,14	70
	MS	0.0028	0.0034	0.0038	0.0044	0.0048	0.0055	230
S12	MS	0,070	0,085	0,095	0,11	0,12	0,14	55
	MS	0.0028	0.0034	0.0038	0.0044	0.0048	0.0055	180
S13	MS	0,065	0,075	0,085	0,095	0,10	0,12	43
	MS	0.0026	0.0030	0.0034	0.0038	0.0040	0.0048	140
H3	P	0,055	0,070	0,080	0,090	0,10	0,12	26
	P	0.0022	0.0028	0.0032	0.0036	0.0040	0.0048	85
H5	P	0,085	0,10	0,12	0,13	0,15	0,18	48
	P	0.0034	0.0040	0.0048	0.0050	0.0060	0.0070	155
H7	P	0,055	0,070	0,080	0,090	0,10	0,12	26
	P	0.0022	0.0028	0.0032	0.0036	0.0040	0.0048	85
H8	P	0,065	0,080	0,090	0,10	0,12	0,14	48
	P	0.0026	0.0032	0.0036	0.0040	0.0048	0.0055	155
H11	P	0,085	0,10	0,12	0,13	0,15	0,18	60
	P	0.0034	0.0040	0.0048	0.0050	0.0060	0.0070	195
H12	P	0,065	0,080	0,090	0,10	0,12	0,14	70
	P	0.0026	0.0032	0.0036	0.0040	0.0048	0.0055	230
H21	P	0,065	0,080	0,090	0,10	0,12	0,14	48
	P	0.0026	0.0032	0.0036	0.0040	0.0048	0.0055	155

SMG = Grupy materiałowe Seco f = mm/obr (cal/obr) v_c = m/min (stp/min) Wszystkie parametry są wartościami początkowymi

SD205A – Ø 10-20 mm / 0.394-0.787 cal

SMG		f						v _c
		Ø 10,00 Ø 0.394	Ø 12,00 Ø 0.472	Ø 14,00 Ø 0.551	Ø 16,00 Ø 0.630	Ø 18,00 Ø 0.709	Ø 20,00 Ø 0.787	
P1	P	0,38	0,44	0,48	0,50	0,55	0,55	170
	P	0,015	0,017	0,019	0,020	0,022	0,022	560
P2	P	0,38	0,44	0,48	0,50	0,55	0,60	165
	P	0,015	0,017	0,019	0,020	0,022	0,024	540
P3	P	0,36	0,42	0,46	0,50	0,50	0,55	140
	P	0,014	0,017	0,018	0,020	0,020	0,022	460
P4	P	0,28	0,30	0,34	0,36	0,38	0,40	195
	P	0,011	0,012	0,013	0,014	0,015	0,016	640
P5	P	0,26	0,30	0,32	0,34	0,36	0,38	185
	P	0,010	0,012	0,013	0,013	0,014	0,015	610
P6	P	0,26	0,30	0,32	0,34	0,36	0,38	210
	P	0,010	0,012	0,013	0,013	0,014	0,015	690
P7	P	0,26	0,30	0,32	0,34	0,36	0,38	200
	P	0,010	0,012	0,013	0,013	0,014	0,015	660
P8	P	0,28	0,32	0,34	0,36	0,38	0,40	185
	P	0,011	0,013	0,013	0,014	0,015	0,016	610
P11	P	0,16	0,18	0,20	0,22	0,24	0,24	95
	P	0,0065	0,0070	0,0080	0,0085	0,0095	0,0095	310
M1	MS	0,22	0,25	0,28	0,30	0,30	0,32	110
	MS	0,0085	0,010	0,011	0,012	0,012	0,013	360
M2	MS	0,20	0,22	0,25	0,26	0,28	0,30	90
	MS	0,0080	0,0085	0,010	0,010	0,011	0,012	295
M3	MS	0,24	0,26	0,28	0,30	0,32	0,34	45
	MS	0,0095	0,010	0,011	0,012	0,013	0,013	150
M4	MS	0,14	0,16	0,17	0,19	0,20	0,20	50
	MS	0,0055	0,0065	0,0065	0,0075	0,0080	0,0080	165
M5	MS	0,14	0,16	0,17	0,19	0,20	0,20	42
	MS	0,0055	0,0065	0,0065	0,0075	0,0080	0,0080	140
K1	P	0,42	0,48	0,50	0,55	0,60	0,65	160
	P	0,017	0,019	0,020	0,022	0,024	0,026	520
K2	P	0,38	0,42	0,48	0,50	0,55	0,55	135
	P	0,015	0,017	0,019	0,020	0,022	0,022	445
K3	P	0,38	0,42	0,48	0,50	0,55	0,55	115
	P	0,015	0,017	0,019	0,020	0,022	0,022	375
K4	P	0,38	0,42	0,48	0,50	0,55	0,55	110
	P	0,015	0,017	0,019	0,020	0,022	0,022	360
K5	P	0,34	0,38	0,42	0,46	0,48	0,50	65
	P	0,013	0,015	0,017	0,018	0,019	0,020	215
N1	N	0,38	0,42	0,46	0,50	0,55	0,55	350
	N	0,015	0,017	0,018	0,020	0,022	0,022	1150
N2	MS	0,38	0,42	0,46	0,50	0,55	0,55	225
	MS	0,015	0,017	0,018	0,020	0,022	0,022	740
N3	MS	0,38	0,42	0,46	0,50	0,55	0,55	150
	MS	0,015	0,017	0,018	0,020	0,022	0,022	490
N11	MS	0,38	0,42	0,46	0,50	0,55	0,55	285
	MS	0,015	0,017	0,018	0,020	0,022	0,022	940
S1	MS	0,11	0,13	0,15	0,16	0,17	0,19	39
	MS	0,0044	0,0050	0,0060	0,0065	0,0065	0,0075	130
S2	MS	0,11	0,13	0,15	0,16	0,17	0,19	28
	MS	0,0044	0,0050	0,0060	0,0065	0,0065	0,0075	90
S3	MS	0,11	0,13	0,15	0,16	0,17	0,19	28
	MS	0,0044	0,0050	0,0060	0,0065	0,0065	0,0075	90
S11	MS	0,17	0,19	0,22	0,24	0,25	0,26	70
	MS	0,0065	0,0075	0,0085	0,0095	0,010	0,010	230
S12	MS	0,17	0,19	0,22	0,24	0,25	0,26	55
	MS	0,0065	0,0075	0,0085	0,0095	0,010	0,010	180
S13	MS	0,15	0,17	0,19	0,20	0,22	0,22	43
	MS	0,0060	0,0065	0,0075	0,0080	0,0085	0,0085	140
H3	P	0,14	0,16	0,18	0,19	0,20	0,20	26
	P	0,0055	0,0065	0,0070	0,0075	0,0080	0,0080	85
H5	P	0,22	0,24	0,26	0,28	0,30	0,32	48
	P	0,0085	0,0095	0,010	0,011	0,012	0,013	155
H7	P	0,14	0,16	0,18	0,19	0,20	0,20	26
	P	0,0055	0,0065	0,0070	0,0075	0,0080	0,0080	85
H8	P	0,16	0,19	0,20	0,22	0,24	0,24	48
	P	0,0065	0,0075	0,0080	0,0085	0,0095	0,0095	155
H11	P	0,22	0,24	0,26	0,28	0,30	0,32	60
	P	0,0085	0,0095	0,010	0,011	0,012	0,013	195
H12	P	0,16	0,19	0,20	0,22	0,24	0,24	70
	P	0,0065	0,0075	0,0080	0,0085	0,0095	0,0095	230
H21	P	0,16	0,19	0,20	0,22	0,24	0,24	48
	P	0,0065	0,0075	0,0080	0,0085	0,0095	0,0095	155

SMG = Grupy materiałowe Seco f = mm/obr (cal/obr) v_c = m/min (stp/min) Wszystkie parametry są wartościami początkowymi

Wstęp

Wiercenie

Rozwiercanie

Wylaczanie

Zalacznik

SD206 – Ø 0,7-2 mm / 0.0276-0.0787 cal

SMG		f			v _c
		Ø 0,70 Ø 0,0276	Ø 1,00 Ø 0,0394	Ø 2,00 Ø 0,0787	
P1	P	0,080	0,090	0,11	140
	P	0,0032	0,0036	0,0044	460
P2	P	0,085	0,090	0,12	140
	P	0,0034	0,0036	0,0048	460
P3	P	0,080	0,085	0,11	120
	P	0,0032	0,0034	0,0044	395
P4	P	0,080	0,085	0,11	105
	P	0,0032	0,0034	0,0044	345
P5	P	0,075	0,085	0,11	100
	P	0,0030	0,0034	0,0044	330
P6	P	0,075	0,080	0,10	110
	P	0,0030	0,0032	0,0040	360
P7	P	0,075	0,080	0,10	105
	P	0,0030	0,0032	0,0040	345
P8	P	0,080	0,085	0,11	100
	P	0,0032	0,0034	0,0044	330
P11	P	0,075	0,080	0,10	105
	P	0,0030	0,0032	0,0040	345
P12	P	0,050	0,055	0,070	60
	P	0,0020	0,0022	0,0028	195
K1	P	0,085	0,090	0,12	100
	P	0,0034	0,0036	0,0048	330
K2	P	0,075	0,085	0,11	85
	P	0,0030	0,0034	0,0044	280
K3	P	0,075	0,085	0,11	75
	P	0,0030	0,0034	0,0044	245
K4	P	0,075	0,085	0,11	70
	P	0,0030	0,0034	0,0044	230
K5	P	0,070	0,075	0,095	42
	P	0,0028	0,0030	0,0038	140

SMG = Grupy materiałowe Seco f = mm/obr (cal/obr) v_c = m/min (stp/min) Wszystkie parametry są wartościami początkowymi

Wstęp

Wiercenie

Rozwiercanie

Wytaczanie

Załącznik

SD206A – Ø 1-2 mm / 0.0394-0.0787 cal

SMG		f			v _c
		Ø 1,00 Ø 0.0394	Ø 1,50 Ø 0.0591	Ø 2,00 Ø 0.0787	
P1	P	0,090	0,10	0,11	175
	P	0,0036	0,0040	0,0044	570
P2	P	0,090	0,10	0,12	170
	P	0,0036	0,0040	0,0048	560
P3	P	0,085	0,10	0,11	145
	P	0,0034	0,0040	0,0044	475
P4	P	0,085	0,095	0,11	130
	P	0,0034	0,0038	0,0044	425
P5	P	0,085	0,095	0,11	125
	P	0,0034	0,0038	0,0044	410
P6	P	0,080	0,095	0,10	140
	P	0,0032	0,0038	0,0040	460
P7	P	0,080	0,095	0,10	130
	P	0,0032	0,0038	0,0040	425
P8	P	0,085	0,10	0,11	125
	P	0,0034	0,0040	0,0044	410
P11	P	0,080	0,095	0,10	125
	P	0,0032	0,0038	0,0040	410
P12	P	0,055	0,065	0,070	75
	P	0,0022	0,0026	0,0028	245
M1	P	0,055	0,065	0,075	95
	P	0,0022	0,0026	0,0030	310
M2	P	0,050	0,060	0,070	75
	P	0,0020	0,0024	0,0028	245
M3	P	0,042	0,048	0,055	60
	P	0,0017	0,0019	0,0022	195
M4	P	0,036	0,042	0,048	43
	P	0,0014	0,0017	0,0019	140
M5	P	0,036	0,042	0,048	36
	P	0,0014	0,0017	0,0019	120
K1	P	0,095	0,11	0,12	115
	P	0,0038	0,0044	0,0048	375
K2	P	0,085	0,10	0,11	100
	P	0,0034	0,0040	0,0044	330
K3	P	0,085	0,10	0,11	85
	P	0,0034	0,0040	0,0044	280
K4	P	0,085	0,10	0,11	80
	P	0,0034	0,0040	0,0044	260
K5	P	0,075	0,090	0,10	47
	P	0,0030	0,0036	0,0040	155
N2	P	0,10	0,12	0,13	190
	P	0,0040	0,0048	0,0050	620
N3	P	0,10	0,12	0,13	125
	P	0,0040	0,0048	0,0050	410

SMG = Grupy materiałowe Seco f = mm/obr (cal/obr) v_c = m/min (stp/min) Wszystkie parametry są wartościami początkowymi

Wstęp

Wiercenie

Rozwiercanie

Wyłaczanie

Załącznik

SD207A – Ø 3-20 mm / 0.118-0.787 cal

SMG		f										v _c
		Ø 3,00 Ø 0.118	Ø 5,00 Ø 0.197	Ø 6,00 Ø 0.236	Ø 8,00 Ø 0.315	Ø 10,00 Ø 0.394	Ø 12,00 Ø 0.472	Ø 14,00 Ø 0.551	Ø 16,00 Ø 0.630	Ø 18,00 Ø 0.709	Ø 20,00 Ø 0.787	
P1	P	0,17	0,24	0,26	0,32	0,38	0,44	0,48	0,50	0,55	0,55	155
	P	0.0065	0.0095	0.010	0.013	0.015	0.017	0.019	0.020	0.022	0.022	510
P2	P	0,17	0,24	0,26	0,32	0,38	0,44	0,48	0,50	0,55	0,60	155
	P	0.0065	0.0095	0.010	0.013	0.015	0.017	0.019	0.020	0.022	0.024	510
P3	P	0,16	0,22	0,25	0,32	0,36	0,42	0,46	0,50	0,50	0,55	130
	P	0.0065	0.0085	0.010	0.013	0.014	0.017	0.018	0.020	0.020	0.022	425
P4	P	0,13	0,17	0,19	0,24	0,28	0,30	0,34	0,36	0,38	0,40	180
	P	0.0050	0.0065	0.0075	0.0095	0.011	0.012	0.013	0.014	0.015	0.016	590
P5	P	0,12	0,17	0,19	0,22	0,26	0,30	0,32	0,34	0,36	0,38	175
	P	0.0048	0.0065	0.0075	0.0085	0.010	0.012	0.013	0.013	0.014	0.015	570
P6	P	0,12	0,16	0,19	0,22	0,26	0,30	0,32	0,34	0,36	0,38	195
	P	0.0048	0.0065	0.0075	0.0085	0.010	0.012	0.013	0.013	0.014	0.015	640
P7	P	0,12	0,16	0,19	0,22	0,26	0,30	0,32	0,34	0,36	0,38	185
	P	0.0048	0.0065	0.0075	0.0085	0.010	0.012	0.013	0.013	0.014	0.015	610
P8	P	0,13	0,17	0,19	0,24	0,28	0,32	0,34	0,36	0,38	0,40	175
	P	0.0050	0.0065	0.0075	0.0095	0.011	0.013	0.013	0.014	0.015	0.016	570
P11	P	0,075	0,10	0,11	0,14	0,16	0,18	0,20	0,22	0,24	0,24	90
	P	0.0030	0.0040	0.0044	0.0055	0.0065	0.0070	0.0080	0.0085	0.0095	0.0095	295
M1	P	0,095	0,13	0,15	0,19	0,22	0,25	0,28	0,30	0,30	0,32	50
	P	0.0038	0.0050	0.0060	0.0075	0.0085	0.010	0.011	0.012	0.012	0.013	165
M2	P	0,085	0,12	0,14	0,17	0,20	0,22	0,25	0,26	0,28	0,30	41
	P	0.0034	0.0048	0.0055	0.0065	0.0080	0.0085	0.010	0.010	0.011	0.012	135
M3	P	0,065	0,095	0,11	0,14	0,16	0,18	0,20	0,22	0,22	0,24	31
	P	0.0026	0.0038	0.0044	0.0055	0.0065	0.0070	0.0080	0.0085	0.0085	0.0095	100
M4	P	0,060	0,085	0,095	0,12	0,14	0,16	0,17	0,19	0,20	0,20	24
	P	0.0024	0.0034	0.0038	0.0048	0.0055	0.0065	0.0065	0.0075	0.0080	0.0080	80
M5	P	0,060	0,085	0,095	0,12	0,14	0,16	0,17	0,19	0,20	0,20	20
	P	0.0024	0.0034	0.0038	0.0048	0.0055	0.0065	0.0065	0.0075	0.0080	0.0080	65
K1	P	0,18	0,25	0,28	0,36	0,42	0,48	0,50	0,55	0,60	0,65	150
	P	0.0070	0.010	0.011	0.014	0.017	0.019	0.020	0.022	0.024	0.026	490
K2	P	0,17	0,22	0,26	0,32	0,38	0,42	0,48	0,50	0,55	0,55	130
	P	0.0065	0.0085	0.010	0.013	0.015	0.017	0.019	0.020	0.022	0.022	425
K3	P	0,17	0,22	0,26	0,32	0,38	0,42	0,48	0,50	0,55	0,55	110
	P	0.0065	0.0085	0.010	0.013	0.015	0.017	0.019	0.020	0.022	0.022	360
K4	P	0,17	0,22	0,26	0,32	0,38	0,42	0,48	0,50	0,55	0,55	105
	P	0.0065	0.0085	0.010	0.013	0.015	0.017	0.019	0.020	0.022	0.022	345
K5	P	0,15	0,20	0,24	0,28	0,34	0,38	0,42	0,46	0,48	0,50	60
	P	0.0060	0.0080	0.0095	0.011	0.013	0.015	0.017	0.018	0.019	0.020	195
H3	P	0,070	0,090	0,10	0,12	0,14	0,16	0,18	0,19	0,20	0,20	24
	P	0.0028	0.0036	0.0040	0.0048	0.0055	0.0065	0.0070	0.0075	0.0080	0.0080	80
H5	P	0,10	0,13	0,15	0,18	0,22	0,24	0,26	0,28	0,30	0,32	45
	P	0.0040	0.0050	0.0060	0.0070	0.0085	0.0095	0.010	0.011	0.012	0.013	150
H7	P	0,070	0,090	0,10	0,12	0,14	0,16	0,18	0,19	0,20	0,20	24
	P	0.0028	0.0036	0.0040	0.0048	0.0055	0.0065	0.0070	0.0075	0.0080	0.0080	80
H8	P	0,080	0,10	0,12	0,14	0,16	0,19	0,20	0,22	0,24	0,24	45
	P	0.0032	0.0040	0.0048	0.0055	0.0065	0.0075	0.0080	0.0085	0.0095	0.0095	150
H11	P	0,10	0,13	0,15	0,18	0,22	0,24	0,26	0,28	0,30	0,32	60
	P	0.0040	0.0050	0.0060	0.0070	0.0085	0.0095	0.010	0.011	0.012	0.013	195
H12	P	0,080	0,10	0,12	0,14	0,16	0,19	0,20	0,22	0,24	0,24	65
	P	0.0032	0.0040	0.0048	0.0055	0.0065	0.0075	0.0080	0.0085	0.0095	0.0095	215
H21	P	0,080	0,10	0,12	0,14	0,16	0,19	0,20	0,22	0,24	0,24	45
	P	0.0032	0.0040	0.0048	0.0055	0.0065	0.0075	0.0080	0.0085	0.0095	0.0095	150

SMG = Grupy materiałowe Seco f = mm/obr (cal/obr) v_c = m/min (stp/min) Wszystkie parametry są wartościami początkowymi

Wstęp

Wiercenie

Rozwiercanie

Wyłaczanie

Załącznik

SD216A – Ø 3-14 mm / 0.118-0.551 cal

SMG		f							v _c
		Ø 3,00 Ø 0.118	Ø 5,00 Ø 0.197	Ø 6,00 Ø 0.236	Ø 8,00 Ø 0.315	Ø 10,00 Ø 0.394	Ø 12,00 Ø 0.472	Ø 14,00 Ø 0.551	
P1	P	0,13	0,18	0,20	0,25	0,30	0,32	0,36	125
	P	0.0050	0.0070	0.0080	0.010	0.012	0.013	0.014	410
P2	P	0,14	0,18	0,20	0,26	0,30	0,34	0,36	120
	P	0.0055	0.0070	0.0080	0.010	0.012	0.013	0.014	395
P3	P	0,13	0,17	0,20	0,24	0,28	0,32	0,34	105
	P	0.0050	0.0065	0.0080	0.0095	0.011	0.013	0.013	345
P4	P	0,13	0,17	0,19	0,24	0,28	0,30	0,34	90
	P	0.0050	0.0065	0.0075	0.0095	0.011	0.012	0.013	295
P5	P	0,12	0,17	0,19	0,24	0,28	0,30	0,34	85
	P	0.0048	0.0065	0.0075	0.0095	0.011	0.012	0.013	280
P6	P	0,12	0,17	0,19	0,24	0,26	0,30	0,32	95
	P	0.0048	0.0065	0.0075	0.0095	0.010	0.012	0.013	310
P7	P	0,12	0,17	0,19	0,24	0,26	0,30	0,32	90
	P	0.0048	0.0065	0.0075	0.0095	0.010	0.012	0.013	295
P8	P	0,13	0,17	0,20	0,24	0,28	0,32	0,34	85
	P	0.0050	0.0065	0.0080	0.0095	0.011	0.013	0.013	280
P11	P	0,12	0,17	0,19	0,24	0,26	0,30	0,32	90
	P	0.0048	0.0065	0.0075	0.0095	0.010	0.012	0.013	295
P12	P	0,085	0,11	0,13	0,16	0,18	0,20	0,22	55
	P	0.0034	0.0044	0.0050	0.0065	0.0070	0.0080	0.0085	180
M1	P	0,095	0,13	0,15	0,19	0,22	0,25	0,28	65
	P	0.0038	0.0050	0.0060	0.0075	0.0085	0.010	0.011	215
M2	P	0,085	0,12	0,14	0,17	0,20	0,22	0,25	55
	P	0.0034	0.0048	0.0055	0.0065	0.0080	0.0085	0.010	180
M3	P	0,070	0,095	0,11	0,14	0,16	0,18	0,20	41
	P	0.0028	0.0038	0.0044	0.0055	0.0065	0.0070	0.0080	135
M4	P	0,060	0,085	0,095	0,12	0,14	0,16	0,18	31
	P	0.0024	0.0034	0.0038	0.0048	0.0055	0.0065	0.0070	100
M5	P	0,060	0,085	0,095	0,12	0,14	0,16	0,18	25
	P	0.0024	0.0034	0.0038	0.0048	0.0055	0.0065	0.0070	80
K1	P	0,15	0,22	0,24	0,30	0,36	0,40	0,44	80
	P	0.0060	0.0085	0.0095	0.012	0.014	0.016	0.017	260
K2	P	0,14	0,19	0,22	0,28	0,32	0,36	0,40	70
	P	0.0055	0.0075	0.0085	0.011	0.013	0.014	0.016	230
K3	P	0,14	0,19	0,22	0,28	0,32	0,36	0,40	60
	P	0.0055	0.0075	0.0085	0.011	0.013	0.014	0.016	195
K4	P	0,14	0,19	0,22	0,28	0,32	0,36	0,40	55
	P	0.0055	0.0075	0.0085	0.011	0.013	0.014	0.016	180
K5	P	0,12	0,17	0,20	0,25	0,30	0,32	0,36	33
	P	0.0048	0.0065	0.0080	0.010	0.012	0.013	0.014	110
N2	P	0,16	0,22	0,26	0,32	0,38	0,42	0,46	135
	P	0.0065	0.0085	0.010	0.013	0.015	0.017	0.018	445
N3	P	0,16	0,22	0,26	0,32	0,38	0,42	0,46	90
	P	0.0065	0.0085	0.010	0.013	0.015	0.017	0.018	295
H3	P	0,055	0,075	0,085	0,10	0,12	0,14	0,15	22
	P	0.0022	0.0030	0.0034	0.0040	0.0048	0.0055	0.0060	70
H5	P	0,085	0,11	0,13	0,16	0,18	0,20	0,22	40
	P	0.0034	0.0044	0.0050	0.0065	0.0070	0.0080	0.0085	130
H7	P	0,055	0,075	0,085	0,10	0,12	0,14	0,15	22
	P	0.0022	0.0030	0.0034	0.0040	0.0048	0.0055	0.0060	70
H8	P	0,065	0,085	0,10	0,12	0,14	0,16	0,17	40
	P	0.0026	0.0034	0.0040	0.0048	0.0055	0.0065	0.0065	130
H11	P	0,085	0,11	0,13	0,16	0,18	0,20	0,22	50
	P	0.0034	0.0044	0.0050	0.0065	0.0070	0.0080	0.0085	165
H12	P	0,065	0,085	0,10	0,12	0,14	0,16	0,17	31
	P	0.0026	0.0034	0.0040	0.0048	0.0055	0.0065	0.0065	100
H21	P	0,065	0,085	0,10	0,12	0,14	0,16	0,17	40
	P	0.0026	0.0034	0.0040	0.0048	0.0055	0.0065	0.0065	130

SMG = Grupy materiałowe Seco f = mm/obr (cal/obr) v_c = m/min (stp/min) Wszystkie parametry są wartościami początkowymi

Wstęp

Wiercenie

Rozwiercanie

Wylaczanie

Zalacznik

SD230A – Ø 3-12 mm / 0.118-0.472 cal

SMG		f						V _c
		Ø 3,00 Ø 0.118	Ø 5,00 Ø 0.197	Ø 6,00 Ø 0.236	Ø 8,00 Ø 0.315	Ø 10,00 Ø 0.394	Ø 12,00 Ø 0.472	
P1	P	0,13	0,18	0,20	0,25	0,30	0,32	90
	P	0.0050	0.0070	0.0080	0.010	0.012	0.013	295
P2	P	0,14	0,18	0,20	0,26	0,30	0,34	90
	P	0.0055	0.0070	0.0080	0.010	0.012	0.013	295
P3	P	0,13	0,17	0,20	0,24	0,28	0,32	75
	P	0.0050	0.0065	0.0080	0.0095	0.011	0.013	245
P4	P	0,13	0,17	0,19	0,24	0,28	0,30	70
	P	0.0050	0.0065	0.0075	0.0095	0.011	0.012	230
P5	P	0,12	0,17	0,19	0,24	0,28	0,30	65
	P	0.0048	0.0065	0.0075	0.0095	0.011	0.012	215
P6	P	0,12	0,17	0,19	0,24	0,26	0,30	75
	P	0.0048	0.0065	0.0075	0.0095	0.010	0.012	245
P7	P	0,12	0,17	0,19	0,24	0,26	0,30	70
	P	0.0048	0.0065	0.0075	0.0095	0.010	0.012	230
P8	P	0,13	0,17	0,20	0,24	0,28	0,32	65
	P	0.0050	0.0065	0.0080	0.0095	0.011	0.013	215
P11	P	0,12	0,17	0,19	0,24	0,26	0,30	65
	P	0.0048	0.0065	0.0075	0.0095	0.010	0.012	215
P12	P	0,085	0,11	0,13	0,16	0,18	0,20	39
	P	0.0034	0.0044	0.0050	0.0065	0.0070	0.0080	130
M1	P	0,095	0,13	0,15	0,19	0,22	0,25	50
	P	0.0038	0.0050	0.0060	0.0075	0.0085	0.010	165
M2	P	0,085	0,12	0,14	0,17	0,20	0,22	40
	P	0.0034	0.0048	0.0055	0.0065	0.0080	0.0085	130
M3	P	0,070	0,095	0,11	0,14	0,16	0,18	30
	P	0.0028	0.0038	0.0044	0.0055	0.0065	0.0070	100
M4	P	0,060	0,085	0,095	0,12	0,14	0,16	23
	P	0.0024	0.0034	0.0038	0.0048	0.0055	0.0065	75
M5	P	0,060	0,085	0,095	0,12	0,14	0,16	19
	P	0.0024	0.0034	0.0038	0.0048	0.0055	0.0065	60
K1	P	0,15	0,22	0,24	0,30	0,36	0,40	60
	P	0.0060	0.0085	0.0095	0.012	0.014	0.016	195
K2	P	0,14	0,19	0,22	0,28	0,32	0,36	50
	P	0.0055	0.0075	0.0085	0.011	0.013	0.014	165
K3	P	0,14	0,19	0,22	0,28	0,32	0,36	44
	P	0.0055	0.0075	0.0085	0.011	0.013	0.014	145
K4	P	0,14	0,19	0,22	0,28	0,32	0,36	42
	P	0.0055	0.0075	0.0085	0.011	0.013	0.014	140
K5	P	0,12	0,17	0,20	0,25	0,30	0,32	25
	P	0.0048	0.0065	0.0080	0.010	0.012	0.013	80
N2	P	0,16	0,22	0,26	0,32	0,38	0,42	100
	P	0.0065	0.0085	0.010	0.013	0.015	0.017	330
N3	P	0,16	0,22	0,26	0,32	0,38	0,42	65
	P	0.0065	0.0085	0.010	0.013	0.015	0.017	215
H3	P	0,055	0,075	0,085	0,10	0,12	0,14	16
	P	0.0022	0.0030	0.0034	0.0040	0.0048	0.0055	50
H5	P	0,085	0,11	0,13	0,16	0,18	0,20	30
	P	0.0034	0.0044	0.0050	0.0065	0.0070	0.0080	100
H7	P	0,055	0,075	0,085	0,10	0,12	0,14	16
	P	0.0022	0.0030	0.0034	0.0040	0.0048	0.0055	50
H8	P	0,065	0,085	0,10	0,12	0,14	0,16	30
	P	0.0026	0.0034	0.0040	0.0048	0.0055	0.0065	100
H11	P	0,085	0,11	0,13	0,16	0,18	0,20	39
	P	0.0034	0.0044	0.0050	0.0065	0.0070	0.0080	130
H12	P	0,065	0,085	0,10	0,12	0,14	0,16	24
	P	0.0026	0.0034	0.0040	0.0048	0.0055	0.0065	80
H21	P	0,065	0,085	0,10	0,12	0,14	0,16	30
	P	0.0026	0.0034	0.0040	0.0048	0.0055	0.0065	100

SMG = Grupy materiałowe Seco f = mm/obr (cal/obr) v_c = m/min (stp/min) Wszystkie parametry są wartościami początkowymi

Wstęp

Wiercenie

Rozwiercanie

Wyłaczanie

Załącznik

SD245A – Ø 4-16 mm / 0.157-0.630 cale

SMG		f							v _c
		Ø 4,00 Ø 0.157	Ø 6,00 Ø 0.236	Ø 8,00 Ø 0.315	Ø 10,00 Ø 0.394	Ø 12,00 Ø 0.472	Ø 14,00 Ø 0.551	Ø 16,00 Ø 0.630	
P1	P	0,11	0,15	0,19	0,22	0,26	0,28	0,32	185
	P	0.0044	0.0060	0.0075	0.0085	0.010	0.011	0.013	610
P2	P	0,11	0,15	0,19	0,22	0,26	0,30	0,32	180
	P	0.0044	0.0060	0.0075	0.0085	0.010	0.012	0.013	590
P3	P	0,11	0,14	0,18	0,22	0,25	0,28	0,30	155
	P	0.0044	0.0055	0.0070	0.0085	0.010	0.011	0.012	510
P4	P	0,11	0,14	0,18	0,22	0,24	0,26	0,30	135
	P	0.0044	0.0055	0.0070	0.0085	0.0095	0.010	0.012	445
P5	P	0,10	0,14	0,17	0,20	0,24	0,26	0,28	130
	P	0.0040	0.0055	0.0065	0.0080	0.0095	0.010	0.011	425
P6	P	0,10	0,14	0,17	0,20	0,24	0,26	0,28	145
	P	0.0040	0.0055	0.0065	0.0080	0.0095	0.010	0.011	475
P7	P	0,10	0,14	0,17	0,20	0,24	0,26	0,28	140
	P	0.0040	0.0055	0.0065	0.0080	0.0095	0.010	0.011	460
P8	P	0,11	0,14	0,18	0,22	0,25	0,28	0,30	130
	P	0.0044	0.0055	0.0070	0.0085	0.010	0.011	0.012	425
P11	P	0,10	0,14	0,17	0,20	0,24	0,26	0,28	135
	P	0.0040	0.0055	0.0065	0.0080	0.0095	0.010	0.011	445
P12	P	0,070	0,095	0,12	0,14	0,16	0,18	0,20	80
	P	0.0028	0.0038	0.0048	0.0055	0.0065	0.0070	0.0080	260
M1	P	0,11	0,15	0,19	0,22	0,26	0,30	0,32	100
	P	0.0044	0.0060	0.0075	0.0085	0.010	0.012	0.013	330
M2	P	0,10	0,14	0,17	0,20	0,24	0,26	0,28	80
	P	0.0040	0.0055	0.0065	0.0080	0.0095	0.010	0.011	260
K1	P	0,11	0,15	0,19	0,22	0,26	0,30	0,32	120
	P	0.0044	0.0060	0.0075	0.0085	0.010	0.012	0.013	395
K2	P	0,10	0,14	0,17	0,20	0,24	0,26	0,28	105
	P	0.0040	0.0055	0.0065	0.0080	0.0095	0.010	0.011	345
K3	P	0,10	0,14	0,17	0,20	0,24	0,26	0,28	90
	P	0.0040	0.0055	0.0065	0.0080	0.0095	0.010	0.011	295
K4	P	0,10	0,14	0,17	0,20	0,24	0,26	0,28	85
	P	0.0040	0.0055	0.0065	0.0080	0.0095	0.010	0.011	280
K5	P	0,095	0,12	0,16	0,19	0,22	0,24	0,26	50
	P	0.0038	0.0048	0.0065	0.0075	0.0085	0.0095	0.010	165
N2	P	0,14	0,19	0,24	0,28	0,34	0,38	0,40	200
	P	0.0055	0.0075	0.0095	0.011	0.013	0.015	0.016	660
N3	P	0,14	0,19	0,24	0,28	0,34	0,38	0,40	135
	P	0.0055	0.0075	0.0095	0.011	0.013	0.015	0.016	445
N11	P	0,14	0,19	0,24	0,28	0,34	0,38	0,40	255
	P	0.0055	0.0075	0.0095	0.011	0.013	0.015	0.016	840

SMG = Grupy materiałowe Seco f = mm/obr (cal/obr) v_c = m/min (stp/min) Wszystkie parametry są wartościami początkowymi

SD265A – Ø 4-16 mm / 0.157-0.630 cal

SMG		f							v _c
		Ø 4,00 Ø 0.157	Ø 6,00 Ø 0.236	Ø 8,00 Ø 0.315	Ø 10,00 Ø 0.394	Ø 12,00 Ø 0.472	Ø 14,00 Ø 0.551	Ø 16,00 Ø 0.630	
P1	P	0,12	0,16	0,20	0,24	0,28	0,30	0,34	180
	P	0.0048	0.0065	0.0080	0.0095	0.011	0.012	0.013	590
P2	P	0,12	0,16	0,20	0,24	0,28	0,30	0,34	175
	P	0.0048	0.0065	0.0080	0.0095	0.011	0.012	0.013	570
P3	P	0,11	0,15	0,19	0,22	0,26	0,30	0,32	150
	P	0.0044	0.0060	0.0075	0.0085	0.010	0.012	0.013	490
P4	P	0,11	0,15	0,19	0,22	0,26	0,28	0,32	135
	P	0.0044	0.0060	0.0075	0.0085	0.010	0.011	0.013	445
P5	P	0,11	0,15	0,18	0,22	0,25	0,28	0,30	130
	P	0.0044	0.0060	0.0070	0.0085	0.010	0.011	0.012	425
P6	P	0,11	0,15	0,18	0,22	0,25	0,28	0,30	145
	P	0.0044	0.0060	0.0070	0.0085	0.010	0.011	0.012	475
P7	P	0,11	0,15	0,18	0,22	0,25	0,28	0,30	135
	P	0.0044	0.0060	0.0070	0.0085	0.010	0.011	0.012	445
P8	P	0,11	0,15	0,19	0,22	0,26	0,30	0,32	130
	P	0.0044	0.0060	0.0075	0.0085	0.010	0.012	0.013	425
P11	P	0,11	0,15	0,18	0,22	0,25	0,28	0,30	130
	P	0.0044	0.0060	0.0070	0.0085	0.010	0.011	0.012	425
P12	P	0,075	0,10	0,12	0,15	0,17	0,19	0,20	80
	P	0.0030	0.0040	0.0048	0.0060	0.0065	0.0075	0.0080	260
M1	P	0,12	0,16	0,20	0,24	0,28	0,30	0,34	100
	P	0.0048	0.0065	0.0080	0.0095	0.011	0.012	0.013	330
M2	P	0,11	0,15	0,18	0,22	0,25	0,28	0,30	80
	P	0.0044	0.0060	0.0070	0.0085	0.010	0.011	0.012	260
K1	P	0,12	0,16	0,20	0,24	0,28	0,30	0,34	120
	P	0.0048	0.0065	0.0080	0.0095	0.011	0.012	0.013	395
K2	P	0,11	0,15	0,18	0,22	0,25	0,28	0,30	100
	P	0.0044	0.0060	0.0070	0.0085	0.010	0.011	0.012	330
K3	P	0,11	0,15	0,18	0,22	0,25	0,28	0,30	85
	P	0.0044	0.0060	0.0070	0.0085	0.010	0.011	0.012	280
K4	P	0,11	0,15	0,18	0,22	0,25	0,28	0,30	85
	P	0.0044	0.0060	0.0070	0.0085	0.010	0.011	0.012	280
K5	P	0,10	0,13	0,17	0,20	0,22	0,25	0,28	49
	P	0.0040	0.0050	0.0065	0.0080	0.0085	0.010	0.011	160
N2	P	0,15	0,20	0,26	0,30	0,36	0,40	0,42	195
	P	0.0060	0.0080	0.010	0.012	0.014	0.016	0.017	640
N3	P	0,15	0,20	0,26	0,30	0,36	0,40	0,42	130
	P	0.0060	0.0080	0.010	0.012	0.014	0.016	0.017	425
N11	P	0,15	0,20	0,26	0,30	0,36	0,40	0,42	250
	P	0.0060	0.0080	0.010	0.012	0.014	0.016	0.017	820

SMG = Grupy materiałowe Seco f = mm/obr (cal/obr) v_c = m/min (stp/min) Wszystkie parametry są wartościami początkowymi

SD203A -MS Ø 2-8 mm / 0.079-0.315 cale

SMG		f						v _c
		Ø 2,00 Ø 0.079	Ø 3,00 Ø 0.118	Ø 4,00 Ø 0.157	Ø 5,00 Ø 0.197	Ø 6,00 Ø 0.236	Ø 8,00 Ø 0.315	
P11	MS	0,060	0,080	0,10	0,12	0,14	0,18	90
	MS	0.0024	0.0032	0.0040	0.0048	0.0055	0.0070	295
P12	MS	0,060	0,070	0,080	0,090	0,10	0,12	65
	MS	0.0024	0.0028	0.0032	0.0036	0.0040	0.0048	215
M1	MS	0,075	0,095	0,11	0,13	0,15	0,19	110
	MS	0.0030	0.0038	0.0044	0.0050	0.0060	0.0075	360
M2	MS	0,065	0,085	0,10	0,12	0,14	0,17	90
	MS	0.0026	0.0034	0.0040	0.0048	0.0055	0.0065	295
M3	MS	0,095	0,11	0,13	0,15	0,17	0,20	45
	MS	0.0038	0.0044	0.0050	0.0060	0.0065	0.0080	150
M4	MS	0,048	0,060	0,070	0,085	0,095	0,12	50
	MS	0.0019	0.0024	0.0028	0.0034	0.0038	0.0048	165
M5	MS	0,048	0,060	0,070	0,085	0,095	0,12	42
	MS	0.0019	0.0024	0.0028	0.0034	0.0038	0.0048	140
N1	MS	0,13	0,16	0,19	0,22	0,26	0,32	345
	MS	0.0050	0.0065	0.0075	0.0085	0.010	0.013	1125
N2	MS	0,13	0,16	0,19	0,22	0,26	0,32	225
	MS	0.0050	0.0065	0.0075	0.0085	0.010	0.013	740
N3	MS	0,13	0,16	0,19	0,22	0,26	0,32	150
	MS	0.0050	0.0065	0.0075	0.0085	0.010	0.013	490
N11	MS	0,13	0,16	0,19	0,22	0,26	0,32	285
	MS	0.0050	0.0065	0.0075	0.0085	0.010	0.013	940
S1	MS	0,040	0,048	0,055	0,065	0,075	0,095	39
	MS	0.0016	0.0019	0.0022	0.0026	0.0030	0.0038	130
S2	MS	0,040	0,048	0,055	0,065	0,075	0,095	28
	MS	0.0016	0.0019	0.0022	0.0026	0.0030	0.0038	90
S3	MS	0,040	0,048	0,055	0,065	0,075	0,095	28
	MS	0.0016	0.0019	0.0022	0.0026	0.0030	0.0038	90
S11	MS	0,070	0,085	0,095	0,11	0,12	0,14	70
	MS	0.0028	0.0034	0.0038	0.0044	0.0048	0.0055	230
S12	MS	0,070	0,085	0,095	0,11	0,12	0,14	55
	MS	0.0028	0.0034	0.0038	0.0044	0.0048	0.0055	180
S13	MS	0,065	0,075	0,085	0,095	0,10	0,12	43
	MS	0.0026	0.0030	0.0034	0.0038	0.0040	0.0048	140
H3	MS	0,046	0,055	0,065	0,075	0,085	0,10	36
	MS	0.0018	0.0022	0.0026	0.0030	0.0034	0.0040	120
H5	MS	0,070	0,085	0,10	0,11	0,13	0,16	65
	MS	0.0028	0.0034	0.0040	0.0044	0.0050	0.0065	215
H7	MS	0,046	0,055	0,065	0,075	0,085	0,10	36
	MS	0.0018	0.0022	0.0026	0.0030	0.0034	0.0040	120
H8	MS	0,055	0,065	0,075	0,085	0,095	0,12	65
	MS	0.0022	0.0026	0.0030	0.0034	0.0038	0.0048	215
H11	MS	0,070	0,085	0,10	0,11	0,13	0,16	85
	MS	0.0028	0.0034	0.0040	0.0044	0.0050	0.0065	280
H12	MS	0,055	0,065	0,075	0,085	0,095	0,12	80
	MS	0.0022	0.0026	0.0030	0.0034	0.0038	0.0048	260
H21	MS	0,055	0,065	0,075	0,085	0,095	0,12	65
	MS	0.0022	0.0026	0.0030	0.0034	0.0038	0.0048	215

SMG = Grupy materiałowe Seco f = mm/obr (cal/obr) v_c = m/min (stp/min) Wszystkie parametry są wartościami początkowymi

Wstęp

Wiercenie

Rozwiercanie

Wyłaczanie

Załącznik

SD203A -MS Ø 10-20 mm / 0.394-0.787 cal

SMG		f						V _c
		Ø 10,00 Ø 0.394	Ø 12,00 Ø 0.472	Ø 14,00 Ø 0.551	Ø 16,00 Ø 0.630	Ø 18,00 Ø 0.709	Ø 20,00 Ø 0.787	
P11	MS	0,22	0,24	0,26	0,30	0,30	0,32	90
	MS	0.0085	0.0095	0.010	0.012	0.012	0.013	295
P12	MS	0,14	0,15	0,16	0,18	0,18	0,19	65
	MS	0.0055	0.0060	0.0065	0.0070	0.0070	0.0075	215
M1	MS	0,22	0,25	0,28	0,30	0,30	0,32	110
	MS	0.0085	0.010	0.011	0.012	0.012	0.013	360
M2	MS	0,20	0,22	0,25	0,26	0,28	0,30	90
	MS	0.0080	0.0085	0.010	0.010	0.011	0.012	295
M3	MS	0,24	0,26	0,28	0,30	0,32	0,34	45
	MS	0.0095	0.010	0.011	0.012	0.013	0.013	150
M4	MS	0,14	0,16	0,17	0,19	0,20	0,20	50
	MS	0.0055	0.0065	0.0065	0.0075	0.0080	0.0080	165
M5	MS	0,14	0,16	0,17	0,19	0,20	0,20	42
	MS	0.0055	0.0065	0.0065	0.0075	0.0080	0.0080	140
N1	MS	0,38	0,42	0,46	0,50	0,55	0,55	345
	MS	0.015	0.017	0.018	0.020	0.022	0.022	1125
N2	MS	0,38	0,42	0,46	0,50	0,55	0,55	225
	MS	0.015	0.017	0.018	0.020	0.022	0.022	740
N3	MS	0,38	0,42	0,46	0,50	0,55	0,55	150
	MS	0.015	0.017	0.018	0.020	0.022	0.022	490
N11	MS	0,38	0,42	0,46	0,50	0,55	0,55	285
	MS	0.015	0.017	0.018	0.020	0.022	0.022	940
S1	MS	0,11	0,13	0,15	0,16	0,17	0,19	39
	MS	0.0044	0.0050	0.0060	0.0065	0.0065	0.0075	130
S2	MS	0,11	0,13	0,15	0,16	0,17	0,19	28
	MS	0.0044	0.0050	0.0060	0.0065	0.0065	0.0075	90
S3	MS	0,11	0,13	0,15	0,16	0,17	0,19	28
	MS	0.0044	0.0050	0.0060	0.0065	0.0065	0.0075	90
S11	MS	0,17	0,19	0,22	0,24	0,25	0,26	70
	MS	0.0065	0.0075	0.0085	0.0095	0.010	0.010	230
S12	MS	0,17	0,19	0,22	0,24	0,25	0,26	55
	MS	0.0065	0.0075	0.0085	0.0095	0.010	0.010	180
S13	MS	0,15	0,17	0,19	0,20	0,22	0,22	43
	MS	0.0060	0.0065	0.0075	0.0080	0.0085	0.0085	140
H3	MS	0,12	0,13	0,15	0,16	0,17	0,17	36
	MS	0.0048	0.0050	0.0060	0.0065	0.0065	0.0065	120
H5	MS	0,18	0,20	0,22	0,24	0,25	0,26	65
	MS	0.0070	0.0080	0.0085	0.0095	0.010	0.010	215
H7	MS	0,12	0,13	0,15	0,16	0,17	0,17	36
	MS	0.0048	0.0050	0.0060	0.0065	0.0065	0.0065	120
H8	MS	0,14	0,16	0,17	0,18	0,19	0,20	65
	MS	0.0055	0.0065	0.0065	0.0070	0.0075	0.0080	215
H11	MS	0,18	0,20	0,22	0,24	0,25	0,26	85
	MS	0.0070	0.0080	0.0085	0.0095	0.010	0.010	280
H12	MS	0,14	0,16	0,17	0,18	0,19	0,20	80
	MS	0.0055	0.0065	0.0065	0.0070	0.0075	0.0080	260
H21	MS	0,14	0,16	0,17	0,18	0,19	0,20	65
	MS	0.0055	0.0065	0.0065	0.0070	0.0075	0.0080	215

SMG = Grupy materiałowe Seco f = mm/obr (cal/obr) v_c = m/min (stp/min) Wszystkie parametry są wartościami początkowymi

SD205A -MS Ø 2-8 mm / 0.079-0.315 cale

SMG		f						v _c
		Ø 2,00 Ø 0.079	Ø 3,00 Ø 0.118	Ø 4,00 Ø 0.157	Ø 5,00 Ø 0.197	Ø 6,00 Ø 0.236	Ø 8,00 Ø 0.315	
P11	MS	0,060	0,080	0,10	0,12	0,14	0,18	80
	MS	0.0024	0.0032	0.0040	0.0048	0.0055	0.0070	260
P12	MS	0,060	0,070	0,080	0,090	0,10	0,12	60
	MS	0.0024	0.0028	0.0032	0.0036	0.0040	0.0048	195
M1	MS	0,075	0,095	0,11	0,13	0,15	0,19	100
	MS	0.0030	0.0038	0.0044	0.0050	0.0060	0.0075	330
M2	MS	0,065	0,085	0,10	0,12	0,14	0,17	80
	MS	0.0026	0.0034	0.0040	0.0048	0.0055	0.0065	260
M3	MS	0,095	0,11	0,13	0,15	0,17	0,20	40
	MS	0.0038	0.0044	0.0050	0.0060	0.0065	0.0080	130
M4	MS	0,048	0,060	0,070	0,085	0,095	0,12	46
	MS	0.0019	0.0024	0.0028	0.0034	0.0038	0.0048	150
M5	MS	0,048	0,060	0,070	0,085	0,095	0,12	38
	MS	0.0019	0.0024	0.0028	0.0034	0.0038	0.0048	125
N1	MS	0,13	0,16	0,19	0,22	0,26	0,32	310
	MS	0.0050	0.0065	0.0075	0.0085	0.010	0.013	1025
N2	MS	0,13	0,16	0,19	0,22	0,26	0,32	200
	MS	0.0050	0.0065	0.0075	0.0085	0.010	0.013	660
N3	MS	0,13	0,16	0,19	0,22	0,26	0,32	135
	MS	0.0050	0.0065	0.0075	0.0085	0.010	0.013	445
N11	MS	0,13	0,16	0,19	0,22	0,26	0,32	255
	MS	0.0050	0.0065	0.0075	0.0085	0.010	0.013	840
S1	MS	0,040	0,048	0,055	0,065	0,075	0,095	35
	MS	0.0016	0.0019	0.0022	0.0026	0.0030	0.0038	115
S2	MS	0,040	0,048	0,055	0,065	0,075	0,095	25
	MS	0.0016	0.0019	0.0022	0.0026	0.0030	0.0038	80
S3	MS	0,040	0,048	0,055	0,065	0,075	0,095	25
	MS	0.0016	0.0019	0.0022	0.0026	0.0030	0.0038	80
S11	MS	0,020	0,030	0,040	0,050	0,060	0,080	45
	MS	0.00080	0.0012	0.0016	0.0020	0.0024	0.0032	150
S12	MS	0,020	0,030	0,040	0,050	0,060	0,080	35
	MS	0.00080	0.0012	0.0016	0.0020	0.0024	0.0032	115
S13	MS	0,017	0,026	0,035	0,044	0,050	0,070	27
	MS	0.00068	0.0010	0.0014	0.0018	0.0020	0.0028	90
H3	MS	0,046	0,055	0,065	0,075	0,085	0,10	33
	MS	0.0018	0.0022	0.0026	0.0030	0.0034	0.0040	110
H5	MS	0,070	0,085	0,10	0,11	0,13	0,16	60
	MS	0.0028	0.0034	0.0040	0.0044	0.0050	0.0065	195
H7	MS	0,046	0,055	0,065	0,075	0,085	0,10	33
	MS	0.0018	0.0022	0.0026	0.0030	0.0034	0.0040	110
H8	MS	0,055	0,065	0,075	0,085	0,095	0,12	60
	MS	0.0022	0.0026	0.0030	0.0034	0.0038	0.0048	195
H11	MS	0,070	0,085	0,10	0,11	0,13	0,16	75
	MS	0.0028	0.0034	0.0040	0.0044	0.0050	0.0065	245
H12	MS	0,055	0,065	0,075	0,085	0,095	0,12	70
	MS	0.0022	0.0026	0.0030	0.0034	0.0038	0.0048	230
H21	MS	0,055	0,065	0,075	0,085	0,095	0,12	60
	MS	0.0022	0.0026	0.0030	0.0034	0.0038	0.0048	195

SMG = Grupy materiałowe Seco f = mm/obr (cal/obr) v_c = m/min (stp/min) Wszystkie parametry są wartościami początkowymi

Wstęp

Wiercenie

Rozwiercanie

Wyłaczanie

Załącznik

SD205A -MS Ø 10-20 mm / 0.394-0.787 cale

SMG		f						V _c
		Ø 10,00 Ø 0.394	Ø 12,00 Ø 0.472	Ø 14,00 Ø 0.551	Ø 16,00 Ø 0.630	Ø 18,00 Ø 0.709	Ø 20,00 Ø 0.787	
P11	MS	0,22	0,24	0,26	0,30	0,30	0,32	80
	MS	0.0085	0.0095	0.010	0.012	0.012	0.013	260
P12	MS	0,14	0,15	0,16	0,18	0,18	0,19	60
	MS	0.0055	0.0060	0.0065	0.0070	0.0070	0.0075	195
M1	MS	0,22	0,25	0,28	0,30	0,30	0,32	100
	MS	0.0085	0.010	0.011	0.012	0.012	0.013	330
M2	MS	0,20	0,22	0,25	0,26	0,28	0,30	80
	MS	0.0080	0.0085	0.010	0.010	0.011	0.012	260
M3	MS	0,24	0,26	0,28	0,30	0,32	0,34	40
	MS	0.0095	0.010	0.011	0.012	0.013	0.013	130
M4	MS	0,14	0,16	0,17	0,19	0,20	0,20	46
	MS	0.0055	0.0065	0.0065	0.0075	0.0080	0.0080	150
M5	MS	0,14	0,16	0,17	0,19	0,20	0,20	38
	MS	0.0055	0.0065	0.0065	0.0075	0.0080	0.0080	125
N1	MS	0,38	0,42	0,46	0,50	0,55	0,55	310
	MS	0.015	0.017	0.018	0.020	0.022	0.022	1025
N2	MS	0,38	0,42	0,46	0,50	0,55	0,55	200
	MS	0.015	0.017	0.018	0.020	0.022	0.022	660
N3	MS	0,38	0,42	0,46	0,50	0,55	0,55	135
	MS	0.015	0.017	0.018	0.020	0.022	0.022	445
N11	MS	0,38	0,42	0,46	0,50	0,55	0,55	255
	MS	0.015	0.017	0.018	0.020	0.022	0.022	840
S1	MS	0,11	0,13	0,15	0,16	0,17	0,19	35
	MS	0.0044	0.0050	0.0060	0.0065	0.0065	0.0075	115
S2	MS	0,11	0,13	0,15	0,16	0,17	0,19	25
	MS	0.0044	0.0050	0.0060	0.0065	0.0065	0.0075	80
S3	MS	0,11	0,13	0,15	0,16	0,17	0,19	25
	MS	0.0044	0.0050	0.0060	0.0065	0.0065	0.0075	80
S11	MS	0,10	0,12	0,14	0,16	0,18	0,20	45
	MS	0.0040	0.0048	0.0055	0.0065	0.0070	0.0080	150
S12	MS	0,10	0,12	0,14	0,16	0,18	0,20	35
	MS	0.0040	0.0048	0.0055	0.0065	0.0070	0.0080	115
S13	MS	0,085	0,11	0,12	0,14	0,16	0,17	27
	MS	0.0034	0.0044	0.0048	0.0055	0.0065	0.0070	90
H3	MS	0,12	0,13	0,15	0,16	0,17	0,17	33
	MS	0.0048	0.0050	0.0060	0.0065	0.0065	0.0065	110
H5	MS	0,18	0,20	0,22	0,24	0,25	0,26	60
	MS	0.0070	0.0080	0.0085	0.0095	0.010	0.010	195
H7	MS	0,12	0,13	0,15	0,16	0,17	0,17	33
	MS	0.0048	0.0050	0.0060	0.0065	0.0065	0.0065	110
H8	MS	0,14	0,16	0,17	0,18	0,19	0,20	60
	MS	0.0055	0.0065	0.0065	0.0070	0.0075	0.0080	195
H11	MS	0,18	0,20	0,22	0,24	0,25	0,26	75
	MS	0.0070	0.0080	0.0085	0.0095	0.010	0.010	245
H12	MS	0,14	0,16	0,17	0,18	0,19	0,20	70
	MS	0.0055	0.0065	0.0065	0.0070	0.0075	0.0080	230
H21	MS	0,14	0,16	0,17	0,18	0,19	0,20	60
	MS	0.0055	0.0065	0.0065	0.0070	0.0075	0.0080	195

SMG = Grupy materiałowe Seco f = mm/obr (cal/obr) v_c = m/min (stp/min) Wszystkie parametry są wartościami początkowymi

SD203A – Ø 2-8 mm / 0.079-0.315 cal

SMG		f						v _c
		Ø 2,00 Ø 0.079	Ø 3,00 Ø 0.118	Ø 4,00 Ø 0.157	Ø 5,00 Ø 0.197	Ø 6,00 Ø 0.236	Ø 8,00 Ø 0.315	
P11	M	0,060	0,075	0,085	0,10	0,11	0,14	150
	M	0.0024	0.0030	0.0034	0.0040	0.0044	0.0055	490
P12	M	0,060	0,075	0,085	0,10	0,11	0,14	90
	M	0.0024	0.0030	0.0034	0.0040	0.0044	0.0055	295
M1	M	0,075	0,095	0,11	0,13	0,15	0,19	110
	M	0.0030	0.0038	0.0044	0.0050	0.0060	0.0075	360
M2	M	0,065	0,085	0,10	0,12	0,14	0,17	90
	M	0.0026	0.0034	0.0040	0.0048	0.0055	0.0065	295
M3	M	0,055	0,065	0,080	0,095	0,11	0,14	70
	M	0.0022	0.0026	0.0032	0.0038	0.0044	0.0055	230
M4	M	0,048	0,060	0,070	0,085	0,095	0,12	50
	M	0.0019	0.0024	0.0028	0.0034	0.0038	0.0048	165
M5	M	0,048	0,060	0,070	0,085	0,095	0,12	42
	M	0.0019	0.0024	0.0028	0.0034	0.0038	0.0048	140
N1	M	0,13	0,16	0,19	0,22	0,26	0,32	345
	M	0.0050	0.0065	0.0075	0.0085	0.010	0.013	1125
N2	M	0,13	0,16	0,19	0,22	0,26	0,32	225
	M	0.0050	0.0065	0.0075	0.0085	0.010	0.013	740
N3	M	0,13	0,16	0,19	0,22	0,26	0,32	150
	M	0.0050	0.0065	0.0075	0.0085	0.010	0.013	490
N11	M	0,13	0,16	0,19	0,22	0,26	0,32	285
	M	0.0050	0.0065	0.0075	0.0085	0.010	0.013	940
S1	M	0,040	0,048	0,055	0,065	0,075	0,095	39
	M	0.0016	0.0019	0.0022	0.0026	0.0030	0.0038	130
S2	M	0,040	0,048	0,055	0,065	0,075	0,095	28
	M	0.0016	0.0019	0.0022	0.0026	0.0030	0.0038	90
S3	M	0,040	0,048	0,055	0,065	0,075	0,095	28
	M	0.0016	0.0019	0.0022	0.0026	0.0030	0.0038	90
S11	M	0,070	0,085	0,095	0,11	0,12	0,14	70
	M	0.0028	0.0034	0.0038	0.0044	0.0048	0.0055	230
S12	M	0,070	0,085	0,095	0,11	0,12	0,14	55
	M	0.0028	0.0034	0.0038	0.0044	0.0048	0.0055	180
S13	M	0,065	0,075	0,085	0,095	0,10	0,12	43
	M	0.0026	0.0030	0.0034	0.0038	0.0040	0.0048	140

SMG = Grupy materiałowe Seco f = mm/obr (cal/obr) v_c = m/min (stp/min) Wszystkie parametry są wartościami początkowymi

SD203A – Ø 10-20 mm / 0.394-0.787 cal

SMG		f						V _c
		Ø 10,00 Ø 0.394	Ø 12,00 Ø 0.472	Ø 14,00 Ø 0.551	Ø 16,00 Ø 0.630	Ø 18,00 Ø 0.709	Ø 20,00 Ø 0.787	
P11	M	0,16	0,18	0,20	0,22	0,24	0,24	150
	M	0.0065	0.0070	0.0080	0.0085	0.0095	0.0095	490
P12	M	0,16	0,18	0,20	0,22	0,24	0,24	90
	M	0.0065	0.0070	0.0080	0.0085	0.0095	0.0095	295
M1	M	0,22	0,25	0,28	0,30	0,30	0,32	110
	M	0.0085	0.010	0.011	0.012	0.012	0.013	360
M2	M	0,20	0,22	0,25	0,26	0,28	0,30	90
	M	0.0080	0.0085	0.010	0.010	0.011	0.012	295
M3	M	0,16	0,18	0,20	0,22	0,22	0,24	70
	M	0.0065	0.0070	0.0080	0.0085	0.0085	0.0095	230
M4	M	0,14	0,16	0,17	0,19	0,20	0,20	50
	M	0.0055	0.0065	0.0065	0.0075	0.0080	0.0080	165
M5	M	0,14	0,16	0,17	0,19	0,20	0,20	42
	M	0.0055	0.0065	0.0065	0.0075	0.0080	0.0080	140
N1	M	0,38	0,42	0,46	0,50	0,55	0,55	345
	M	0.015	0.017	0.018	0.020	0.022	0.022	1125
N2	M	0,38	0,42	0,46	0,50	0,55	0,55	225
	M	0.015	0.017	0.018	0.020	0.022	0.022	740
N3	M	0,38	0,42	0,46	0,50	0,55	0,55	150
	M	0.015	0.017	0.018	0.020	0.022	0.022	490
N11	M	0,38	0,42	0,46	0,50	0,55	0,55	285
	M	0.015	0.017	0.018	0.020	0.022	0.022	940
S1	M	0,11	0,13	0,15	0,16	0,17	0,19	39
	M	0.0044	0.0050	0.0060	0.0065	0.0065	0.0075	130
S2	M	0,11	0,13	0,15	0,16	0,17	0,19	28
	M	0.0044	0.0050	0.0060	0.0065	0.0065	0.0075	90
S3	M	0,11	0,13	0,15	0,16	0,17	0,19	28
	M	0.0044	0.0050	0.0060	0.0065	0.0065	0.0075	90
S11	M	0,17	0,19	0,22	0,24	0,25	0,26	70
	M	0.0065	0.0075	0.0085	0.0095	0.010	0.010	230
S12	M	0,17	0,19	0,22	0,24	0,25	0,26	55
	M	0.0065	0.0075	0.0085	0.0095	0.010	0.010	180
S13	M	0,15	0,17	0,19	0,20	0,22	0,22	43
	M	0.0060	0.0065	0.0075	0.0080	0.0085	0.0085	140

SMG = Grupy materiałowe Seco f = mm/obr (cal/obr) v_c = m/min (stp/min) Wszystkie parametry są wartościami początkowymi

SD205A-M – Ø 2-8 mm / 0.079-0.315 cal

SMG		f						v _c
		Ø2,00 Ø 0.079	Ø3,00 Ø 0.118	Ø4,00 Ø 0.157	Ø5,00 Ø 0.197	Ø6,00 Ø 0.236	Ø8,00 Ø 0.315	
P11	M	0,060	0,075	0,085	0,10	0,11	0,14	135
	M	0.0024	0.0030	0.0034	0.0040	0.0044	0.0055	445
P12	M	0,060	0,075	0,085	0,10	0,11	0,14	80
	M	0.0024	0.0030	0.0034	0.0040	0.0044	0.0055	260
M1	M	0,075	0,095	0,11	0,13	0,15	0,19	100
	M	0.0030	0.0038	0.0044	0.0050	0.0060	0.0075	330
M2	M	0,065	0,085	0,10	0,12	0,14	0,17	80
	M	0.0026	0.0034	0.0040	0.0048	0.0055	0.0065	260
M3	M	0,055	0,065	0,080	0,095	0,11	0,14	60
	M	0.0022	0.0026	0.0032	0.0038	0.0044	0.0055	195
M4	M	0,048	0,060	0,070	0,085	0,095	0,12	46
	M	0.0019	0.0024	0.0028	0.0034	0.0038	0.0048	150
M5	M	0,048	0,060	0,070	0,085	0,095	0,12	38
	M	0.0019	0.0024	0.0028	0.0034	0.0038	0.0048	125
N1	M	0,13	0,16	0,19	0,22	0,26	0,32	310
	M	0.0050	0.0065	0.0075	0.0085	0.010	0.013	1025
N2	M	0,13	0,16	0,19	0,22	0,26	0,32	200
	M	0.0050	0.0065	0.0075	0.0085	0.010	0.013	660
N3	M	0,13	0,16	0,19	0,22	0,26	0,32	135
	M	0.0050	0.0065	0.0075	0.0085	0.010	0.013	445
N11	M	0,13	0,16	0,19	0,22	0,26	0,32	255
	M	0.0050	0.0065	0.0075	0.0085	0.010	0.013	840
S1	M	0,040	0,048	0,055	0,065	0,075	0,095	35
	M	0.0016	0.0019	0.0022	0.0026	0.0030	0.0038	115
S2	M	0,040	0,048	0,055	0,065	0,075	0,095	25
	M	0.0016	0.0019	0.0022	0.0026	0.0030	0.0038	80
S3	M	0,040	0,048	0,055	0,065	0,075	0,095	25
	M	0.0016	0.0019	0.0022	0.0026	0.0030	0.0038	80
S11	M	0,070	0,085	0,095	0,11	0,12	0,14	65
	M	0.0028	0.0034	0.0038	0.0044	0.0048	0.0055	215
S12	M	0,070	0,085	0,095	0,11	0,12	0,14	50
	M	0.0028	0.0034	0.0038	0.0044	0.0048	0.0055	165
S13	M	0,065	0,075	0,085	0,095	0,10	0,12	39
	M	0.0026	0.0030	0.0034	0.0038	0.0040	0.0048	130

SMG = Grupy materiałowe Seco f = mm/obr (cal/obr) v_c = m/min (stp/min) Wszystkie parametry są wartościami początkowymi

Wstęp

Wiercenie

Rozwiercanie

Wyłaczanie

Załącznik

SD205A-M – Ø 10-20 mm / 0.394-0.787 cal

SMG		f						V _c
		Ø10,00 Ø 0.394	Ø12,00 Ø 0.472	Ø14,00 Ø 0.551	Ø16,00 Ø 0.630	Ø18,00 Ø 0.709	Ø20,00 Ø 0.787	
P11	M	0,16	0,18	0,20	0,22	0,24	0,24	135
	M	0.0065	0.0070	0.0080	0.0085	0.0095	0.0095	445
P12	M	0,16	0,18	0,20	0,22	0,24	0,24	80
	M	0.0065	0.0070	0.0080	0.0085	0.0095	0.0095	260
M1	M	0,22	0,25	0,28	0,30	0,30	0,32	100
	M	0.0085	0.010	0.011	0.012	0.012	0.013	330
M2	M	0,20	0,22	0,25	0,26	0,28	0,30	80
	M	0.0080	0.0085	0.010	0.010	0.011	0.012	260
M3	M	0,16	0,18	0,20	0,22	0,22	0,24	60
	M	0.0065	0.0070	0.0080	0.0085	0.0085	0.0095	195
M4	M	0,14	0,16	0,17	0,19	0,20	0,20	45
	M	0.0055	0.0065	0.0065	0.0075	0.0080	0.0080	150
M5	M	0,14	0,16	0,17	0,19	0,20	0,20	37
	M	0.0055	0.0065	0.0065	0.0075	0.0080	0.0080	120
N1	M	0,38	0,42	0,46	0,50	0,55	0,55	305
	M	0.015	0.017	0.018	0.020	0.022	0.022	1000
N2	M	0,38	0,42	0,46	0,50	0,55	0,55	195
	M	0.015	0.017	0.018	0.020	0.022	0.022	640
N3	M	0,38	0,42	0,46	0,50	0,55	0,55	130
	M	0.015	0.017	0.018	0.020	0.022	0.022	425
N11	M	0,38	0,42	0,46	0,50	0,55	0,55	250
	M	0.015	0.017	0.018	0.020	0.022	0.022	820
S1	M	0,11	0,13	0,15	0,16	0,17	0,19	34
	M	0.0044	0.0050	0.0060	0.0065	0.0065	0.0075	110
S2	M	0,11	0,13	0,15	0,16	0,17	0,19	25
	M	0.0044	0.0050	0.0060	0.0065	0.0065	0.0075	80
S3	M	0,11	0,13	0,15	0,16	0,17	0,19	25
	M	0.0044	0.0050	0.0060	0.0065	0.0065	0.0075	80
S11	M	0,17	0,19	0,22	0,24	0,25	0,26	65
	M	0.0065	0.0075	0.0085	0.0095	0.010	0.010	215
S12	M	0,17	0,19	0,22	0,24	0,25	0,26	49
	M	0.0065	0.0075	0.0085	0.0095	0.010	0.010	160
S13	M	0,15	0,17	0,19	0,20	0,22	0,22	38
	M	0.0060	0.0065	0.0075	0.0080	0.0085	0.0085	125

SMG = Grupy materiałowe Seco f = mm/obr (cal/obr) v_c= m/min (stp/min) Wszystkie parametry są wartościami początkowymi

Wstęp

Wiercenie

Rozwiercanie

Wytaczanie

Załącznik

SD205A-C1 – Ø 3-13 mm / 0.118-0.512 cale

SMG		f						v _c
		Ø 3,00 Ø 0.118	Ø 5,00 Ø 0.197	Ø 7,00 Ø 0.276	Ø 9,00 Ø 0.354	Ø 11,00 Ø 0.433	Ø 13,00 Ø 0.512	
TS2	C1	0,060	0,060	0,065	0,070	0,075	0,080	65
	C1	0.0024	0.0024	0.0026	0.0028	0.0030	0.0032	215
TS3	C1	0,060	0,060	0,065	0,070	0,075	0,080	50
	C1	0.0024	0.0024	0.0026	0.0028	0.0030	0.0032	165
TP2	C1	0,060	0,060	0,065	0,070	0,075	0,080	65
	C1	0.0024	0.0024	0.0026	0.0028	0.0030	0.0032	215
TP3	C1	0,060	0,060	0,065	0,070	0,075	0,080	50
	C1	0.0024	0.0024	0.0026	0.0028	0.0030	0.0032	165

SD205A-C2 – Ø 3-13 mm / 0.118-0.512 cale

SMG		f						v _c
		Ø 3,00 Ø 0.118	Ø 5,00 Ø 0.197	Ø 7,00 Ø 0.276	Ø 9,00 Ø 0.354	Ø 11,00 Ø 0.433	Ø 13,00 Ø 0.512	
N1	C2	0,095	0,10	0,11	0,12	0,13	0,14	80
	C2	0.0038	0.0040	0.0044	0.0048	0.0050	0.0055	260
N2	C2	0,095	0,10	0,11	0,12	0,13	0,14	50
	C2	0.0038	0.0040	0.0044	0.0048	0.0050	0.0055	165
N3	C2	0,095	0,10	0,11	0,12	0,13	0,14	33
	C2	0.0038	0.0040	0.0044	0.0048	0.0050	0.0055	110
S11	C2	0,055	0,065	0,080	0,090	0,10	0,11	50
	C2	0.0022	0.0026	0.0032	0.0036	0.0040	0.0044	165
S12	C2	0,055	0,065	0,080	0,090	0,10	0,11	40
	C2	0.0022	0.0026	0.0032	0.0036	0.0040	0.0044	130
S13	C2	0,048	0,060	0,070	0,080	0,090	0,10	31
	C2	0.0019	0.0024	0.0028	0.0032	0.0036	0.0040	100

SD203-CX1 – Ø 3-9 mm / 0.118-0.354 cale

SMG		f				v _c
		Ø 3,00 Ø 0.118	Ø 5,00 Ø 0.197	Ø 7,00 Ø 0.276	Ø 9,00 Ø 0.354	
TS2	CX1	0,075	0,085	0,090	0,10	150
	CX1	0.0030	0.0034	0.0036	0.0040	490
TS3	CX1	0,075	0,085	0,090	0,10	120
	CX1	0.0030	0.0034	0.0036	0.0040	395
TP2	CX1	0,075	0,085	0,090	0,10	150
	CX1	0.0030	0.0034	0.0036	0.0040	490
TP3	CX1	0,075	0,085	0,090	0,10	120
	CX1	0.0030	0.0034	0.0036	0.0040	395

Wstęp

Wiercenie

Rozwiercanie

Wytaczanie

Załącznik

SD22 & SD26 – Ø 0,1-0,3 mm / 0.0039-0.0118 cal

SMG	f			v _c
	Ø 0,10 Ø 0.0039	Ø 0,20 Ø 0.0079	Ø 0,30 Ø 0.0118	
P1	0,0011	0,0017	0,0024	11
	0.000044	0.000065	0.000095	36
P2	0,0011	0,0017	0,0024	11
	0.000044	0.000065	0.000095	36
P3	0,0010	0,0016	0,0022	10
	0.000040	0.000065	0.000085	33
P4	0,0010	0,0016	0,0022	8
	0.000040	0.000065	0.000085	26
P5	0,0010	0,0016	0,0022	8
	0.000040	0.000065	0.000085	26
P6	0,0010	0,0016	0,0022	9
	0.000040	0.000065	0.000085	30
P7	0,0010	0,0016	0,0022	8
	0.000040	0.000065	0.000085	26
P8	0,0010	0,0016	0,0022	8
	0.000040	0.000065	0.000085	26
P11	0,0010	0,0016	0,0022	8
	0.000040	0.000065	0.000085	26
P12	0,00070	0,0011	0,0015	5
	0.000028	0.000044	0.000060	16
M1	0,0011	0,0017	0,0024	2
	0.000044	0.000065	0.000095	7
M2	0,0010	0,0016	0,0022	2
	0.000040	0.000065	0.000085	7
K1	0,0011	0,0017	0,0024	6
	0.000044	0.000065	0.000095	20
K2	0,0010	0,0016	0,0022	5
	0.000040	0.000065	0.000085	16
K3	0,0010	0,0016	0,0022	4
	0.000040	0.000065	0.000085	13
K4	0,0010	0,0016	0,0022	4
	0.000040	0.000065	0.000085	13
K5	0,00090	0,0014	0,0019	3
	0.000036	0.000055	0.000075	10
N2	0,0014	0,0022	0,0030	15
	0.000055	0.000085	0.00012	49
N3	0,0014	0,0022	0,0030	10
	0.000055	0.000085	0.00012	33
S11	0,00080	0,0013	0,0017	4
	0.000032	0.000050	0.000065	13
S12	0,00080	0,0013	0,0017	3
	0.000032	0.000050	0.000065	10

SMG = Grupy materiałowe Seco f = mm/obr (cal/obr) v_c = m/min (stp/min) Wszystkie parametry są wartościami początkowymi

Wstęp

Wiercenie

Rozwiercanie

Wyłaczanie

Załącznik

SD22 & SD26 – \varnothing 0,4-0,5 mm / 0.0157-0.0197 cal

SMG	f		v _c
	\varnothing 0,40 \varnothing 0.0157	\varnothing 0,50 \varnothing 0.0197	
P1	0,0030	0,0036	14
	0.00012	0.00014	46
P2	0,0030	0,0036	14
	0.00012	0.00014	46
P3	0,0028	0,0034	12
	0.00011	0.00013	39
P4	0,0028	0,0034	10
	0.00011	0.00013	33
P5	0,0028	0,0034	10
	0.00011	0.00013	33
P6	0,0028	0,0032	11
	0.00011	0.00013	36
P7	0,0028	0,0032	11
	0.00011	0.00013	36
P8	0,0028	0,0034	10
	0.00011	0.00013	33
P11	0,0028	0,0032	10
	0.00011	0.00013	33
P12	0,0019	0,0022	6
	0.000075	0.000085	20
M1	0,0030	0,0036	5
	0.00012	0.00014	16
M2	0,0028	0,0034	4
	0.00011	0.00013	13
K1	0,0030	0,0036	10
	0.00012	0.00014	33
K2	0,0028	0,0034	9
	0.00011	0.00013	30
K3	0,0028	0,0034	7
	0.00011	0.00013	23
K4	0,0028	0,0034	7
	0.00011	0.00013	23
K5	0,0025	0,0030	4
	0.00010	0.00012	13
N2	0,0038	0,0046	30
	0.00015	0.00018	100
N3	0,0038	0,0046	20
	0.00015	0.00018	65
S11	0,0022	0,0026	8
	0.000085	0.00010	26
S12	0,0022	0,0026	6
	0.000085	0.00010	20

SMG = Grupy materiałowe Seco f = mm/obr (cal/obr) v_c = m/min (stp/min) Wszystkie parametry są wartościami początkowymi

Wstęp

Wiercenie

Rozwiercanie

Wyłaczanie

Załącznik

SD22 & SD26 – Ø 0,6-0,8 mm / 0.0236-0.0315 cale

SMG	f			v _c
	Ø 0,60 Ø 0.0236	Ø 0,70 Ø 0.0276	Ø 0,80 Ø 0.0315	
P1	0,0042	0,0048	0,0055	28
	0.00017	0.00019	0.00022	90
P2	0,0042	0,0050	0,0055	28
	0.00017	0.00020	0.00022	90
P3	0,0040	0,0046	0,0055	24
	0.00016	0.00018	0.00022	80
P4	0,0040	0,0046	0,0050	21
	0.00016	0.00018	0.00020	70
P5	0,0038	0,0044	0,0050	20
	0.00015	0.00017	0.00020	65
P6	0,0038	0,0044	0,0050	22
	0.00015	0.00017	0.00020	70
P7	0,0038	0,0044	0,0050	21
	0.00015	0.00017	0.00020	70
P8	0,0040	0,0046	0,0055	20
	0.00016	0.00018	0.00022	65
P11	0,0038	0,0044	0,0050	21
	0.00015	0.00017	0.00020	70
P12	0,0026	0,0030	0,0034	12
	0.00010	0.00012	0.00013	39
M1	0,0042	0,0050	0,0055	9
	0.00017	0.00020	0.00022	30
M2	0,0038	0,0044	0,0050	7
	0.00015	0.00017	0.00020	23
K1	0,0042	0,0050	0,0055	15
	0.00017	0.00020	0.00022	49
K2	0,0038	0,0044	0,0050	13
	0.00015	0.00017	0.00020	43
K3	0,0038	0,0044	0,0050	11
	0.00015	0.00017	0.00020	36
K4	0,0038	0,0044	0,0050	10
	0.00015	0.00017	0.00020	33
K5	0,0036	0,0040	0,0046	6
	0.00014	0.00016	0.00018	20
N2	0,0055	0,0065	0,0070	60
	0.00022	0.00026	0.00028	195
N3	0,0055	0,0065	0,0070	40
	0.00022	0.00026	0.00028	130
S11	0,0032	0,0036	0,0040	13
	0.00013	0.00014	0.00016	43
S12	0,0032	0,0036	0,0040	10
	0.00013	0.00014	0.00016	33

SMG = Grupy materiałowe Seco f = mm/obr (cal/obr) v_c = m/min (stp/min) Wszystkie parametry są wartościami początkowymi

Wstęp

Wiercenie

Rozwiercanie

Wytaczanie

Załącznik

SD22 & SD26 – \varnothing 0,9-1,1 mm / 0.0354-0.0433 cale

SMG	f			v _c
	\varnothing 0,90 <i>0.0354</i>	\varnothing 1,00 <i>0.0394</i>	\varnothing 1,10 <i>0.0433</i>	
P1	0,0060	0,0065	0,0075	50
	<i>0.00024</i>	<i>0.00026</i>	<i>0.00030</i>	165
P2	0,0060	0,0070	0,0075	48
	<i>0.00024</i>	<i>0.00028</i>	<i>0.00030</i>	155
P3	0,0060	0,0065	0,0070	42
	<i>0.00024</i>	<i>0.00026</i>	<i>0.00028</i>	140
P4	0,0055	0,0065	0,0070	37
	<i>0.00022</i>	<i>0.00026</i>	<i>0.00028</i>	120
P5	0,0055	0,0060	0,0070	35
	<i>0.00022</i>	<i>0.00024</i>	<i>0.00028</i>	115
P6	0,0055	0,0060	0,0065	39
	<i>0.00022</i>	<i>0.00024</i>	<i>0.00026</i>	130
P7	0,0055	0,0060	0,0065	37
	<i>0.00022</i>	<i>0.00024</i>	<i>0.00026</i>	120
P8	0,0060	0,0065	0,0070	35
	<i>0.00024</i>	<i>0.00026</i>	<i>0.00028</i>	115
P11	0,0055	0,0060	0,0065	36
	<i>0.00022</i>	<i>0.00024</i>	<i>0.00026</i>	120
P12	0,0038	0,0042	0,0046	21
	<i>0.00015</i>	<i>0.00017</i>	<i>0.00018</i>	70
M1	0,0060	0,0070	0,0075	12
	<i>0.00024</i>	<i>0.00028</i>	<i>0.00030</i>	39
M2	0,0055	0,0060	0,0070	10
	<i>0.00022</i>	<i>0.00024</i>	<i>0.00028</i>	33
K1	0,0060	0,0070	0,0075	20
	<i>0.00024</i>	<i>0.00028</i>	<i>0.00030</i>	65
K2	0,0055	0,0060	0,0070	17
	<i>0.00022</i>	<i>0.00024</i>	<i>0.00028</i>	55
K3	0,0055	0,0060	0,0070	15
	<i>0.00022</i>	<i>0.00024</i>	<i>0.00028</i>	49
K4	0,0055	0,0060	0,0070	14
	<i>0.00022</i>	<i>0.00024</i>	<i>0.00028</i>	46
K5	0,0050	0,0055	0,0060	8
	<i>0.00020</i>	<i>0.00022</i>	<i>0.00024</i>	26
N2	0,0080	0,0085	0,0095	80
	<i>0.00032</i>	<i>0.00034</i>	<i>0.00038</i>	260
N3	0,0080	0,0085	0,0095	55
	<i>0.00032</i>	<i>0.00034</i>	<i>0.00038</i>	180
S11	0,0046	0,0050	0,0055	19
	<i>0.00018</i>	<i>0.00020</i>	<i>0.00022</i>	60
S12	0,0046	0,0050	0,0055	15
	<i>0.00018</i>	<i>0.00020</i>	<i>0.00022</i>	49

SMG = Grupy materiałowe Seco f = mm/obr (cal/obr) v_c = m/min (stp/min) Wszystkie parametry są wartościami początkowymi

Wstęp

Wiercenie

Rozwiercanie

Wyłaczanie

Załącznik

SD22 & SD26 – Ø 1,2-2,0 mm / 0.0472-0.0787 cal

SMG	f					v _c
	Ø 1,20 Ø 0.0472	Ø 1,40 Ø 0.0551	Ø 1,60 Ø 0.0630	Ø 1,80 Ø 0.0709	Ø 2,00 Ø 0.0787	
P1	0,0080	0,0090	0,010	0,012	0,013	70
	0.00032	0.00036	0.00040	0.00048	0.00050	230
P2	0,0080	0,0095	0,011	0,012	0,013	70
	0.00032	0.00038	0.00044	0.00048	0.00050	230
P3	0,0075	0,0090	0,010	0,011	0,012	60
	0.00030	0.00036	0.00040	0.00044	0.00048	195
P4	0,0075	0,0085	0,010	0,011	0,012	50
	0.00030	0.00034	0.00040	0.00044	0.00048	165
P5	0,0075	0,0085	0,0095	0,011	0,012	50
	0.00030	0.00034	0.00038	0.00044	0.00048	165
P6	0,0075	0,0085	0,0095	0,011	0,012	55
	0.00030	0.00034	0.00038	0.00044	0.00048	180
P7	0,0075	0,0085	0,0095	0,011	0,012	55
	0.00030	0.00034	0.00038	0.00044	0.00048	180
P8	0,0075	0,0090	0,010	0,011	0,012	50
	0.00030	0.00036	0.00040	0.00044	0.00048	165
P11	0,0075	0,0085	0,0095	0,011	0,012	50
	0.00030	0.00034	0.00038	0.00044	0.00048	165
P12	0,0050	0,0060	0,0065	0,0075	0,0080	30
	0.00020	0.00024	0.00026	0.00030	0.00032	100
M1	0,0080	0,0095	0,011	0,012	0,013	15
	0.00032	0.00038	0.00044	0.00048	0.00050	49
M2	0,0075	0,0085	0,0095	0,011	0,012	12
	0.00030	0.00034	0.00038	0.00044	0.00048	39
K1	0,0080	0,0095	0,011	0,012	0,013	35
	0.00032	0.00038	0.00044	0.00048	0.00050	115
K2	0,0075	0,0085	0,0095	0,011	0,012	30
	0.00030	0.00034	0.00038	0.00044	0.00048	100
K3	0,0075	0,0085	0,0095	0,011	0,012	26
	0.00030	0.00034	0.00038	0.00044	0.00048	85
K4	0,0075	0,0085	0,0095	0,011	0,012	25
	0.00030	0.00034	0.00038	0.00044	0.00048	80
K5	0,0065	0,0075	0,0085	0,010	0,011	15
	0.00026	0.00030	0.00034	0.00040	0.00044	49
N2	0,010	0,012	0,014	0,015	0,017	100
	0.00040	0.00048	0.00055	0.00060	0.00065	330
N3	0,010	0,012	0,014	0,015	0,017	65
	0.00040	0.00048	0.00055	0.00060	0.00065	215
S11	0,0060	0,0070	0,0075	0,0085	0,0095	26
	0.00024	0.00028	0.00030	0.00034	0.00038	85
S12	0,0060	0,0070	0,0075	0,0085	0,0095	20
	0.00024	0.00028	0.00030	0.00034	0.00038	65

SMG = Grupy materiałowe Seco f = mm/obr (cal/obr) v_c = m/min (stp/min) Wszystkie parametry są wartościami początkowymi

Wstęp

Wiercenie

Rozwiercanie

Wyłaczanie

Załącznik





Seco Crownloc®

Crownloc® to wiertła z wymiennymi końcówkami zaprojektowane z myślą o zapewnieniu najwyższej jakości otworów przy niższych kosztach. W charakteryzujących się wysoką jakością i precyzją wiertłach Crownloc zastosowano wymienne końcówki, co pozwala wyeliminować koszty regeneracji.

- Dwa otwory na chłodziwo przez końcówkę zapewniają dotarcie dużej ilości chłodziwa do krawędzi skrawających.
- Wiertła Crownloc® są dostępne w szerokim asortymencie optymalnych geometrii do różnych zastosowań i materiałów obrabianych.

Przegląd asortymentu

Crownloc®	Zakres \varnothing	Głębokość wiercenia	Tolerancja \varnothing otworu	Tolerancja otworu (1)	Wykończenie powierzchni (2)
SD101  Str. - 173-174	12,00-25,99 mm (0.472-1.023")	1,5 x D	k7	IT 10	Ra 1-3 μm (Ra 39-118 μin)
SD103  Str. - 175-176	9,52-25,99 mm (0.375-1.023")	3 x D	k7	IT 10	Ra 1-3 μm (Ra 39-118 μin)
SD105  Str. - 177-178	10,00-25,99 mm (0.394-1.023")	5 x D	k7	IT 10	Ra 1-3 μm (Ra 39-118 μin)
SD107  Str. - 179-180	12,00-25,99 mm (0.472-1.023")	7 x D	k7	IT 10	Ra 1-4 μm (Ra 39-157 μin)
Moduł fazujący  Str. - 188	12,00-19,99 mm (0.472-0.787")	-	-	-	-

1) mogą wystąpić różnice w zależności od materiału i stosowanych parametrów.

2) głębokość wiercenia, parametry, ciśnienie chłodziwa i materiał mogą spowodować pogorszenie wykończenia powierzchni.

Oznaczenia

Oznaczenie korpusu wiertła

Metryczne



Oznaczenia końcówki

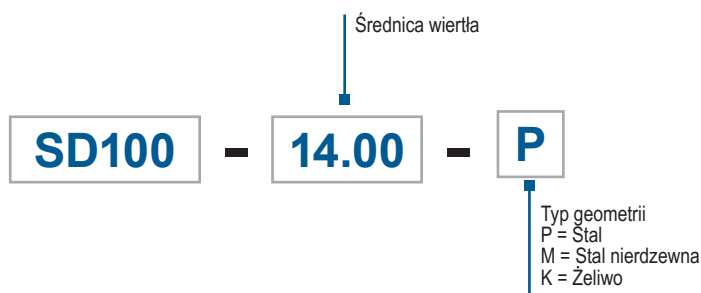

Geometrie

Geometria -P
- Geometria uniwersalna, pierwszy wybór do wiercenia w stali

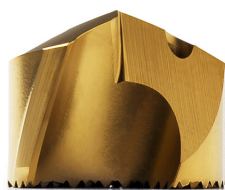

Geometria -M
- Do stali nierdzewnych oraz stopów żaroodpornych



Geometria -K
- Pierwszy wybór do wiercenia w żeliwie



Zestawy części zamiennych

Średnica wiertła mm (Całowe)	SD101	SD103	SD105	SD107
10,00-11,99	-	SD103-SP-4.0	SD105-SP-4.0	-
12,00-13,99	SD101-SP-5.0	SD103-SP-5.0	SD105-SP-5.0	SD107-SP-5.0
14,00-16,99	SD101-SP-6.0	SD103-SP-6.0	SD105-SP-6.0	SD107-SP-6.0
17,00-19,99	SD101-SP-7.0	SD103-SP-7.0	SD105-SP-7.0	SD107-SP-7.0
20,00-25,99	SD101-SP-8.0	SD103-SP-8.0	SD105-SP-8.0	SD107-SP-8.0

Wskazówki dotyczące mocowania

1. Starannie oczyścić powierzchnię gniazda w korpusie wiertła w celu usunięcia wiórów lub innych zanieczyszczeń.
2. Sprawdzić czy pręt ściągający jest odpowiednio wysunięty z korpusu.
3. Założyć nową końcówkę na pręt ściągający nakręcając ją aż osiągnie koniec gwintu.

Obrócić końcówkę wiertła w kierunku przeciwnym do ruchu zegara aby dopasować gniazda.

Docisnąć końcówkę do korpusu we właściwej pozycji i dokręcić śrubę mocującą.

Następnie upewnić się czy końcówka została zamocowana.

Mocno dokręcić śrubę mocującą stosując klucz dynamometryczny.

Stabilność

Stabilność obróbki bardzo mocno wpływa na trwałość ostrza oraz dokładność otworu. Należy sprawdzić stan wrzeciona obrabiarki, przyrządu oraz zamocowanie detalu dla zapewnienia maksymalnej stabilności i sztywności. Niestabilne warunki mogą spowodować złamanie narzędzia.

Obrotowe

Całkowite zmierzone bicie przy zast. obrotowym nie powinno przekraczać 0,06 mm (0.002"). Bicie należy zmierzyć gdy wiertło jest zamontowane we wrzecionie.

1.

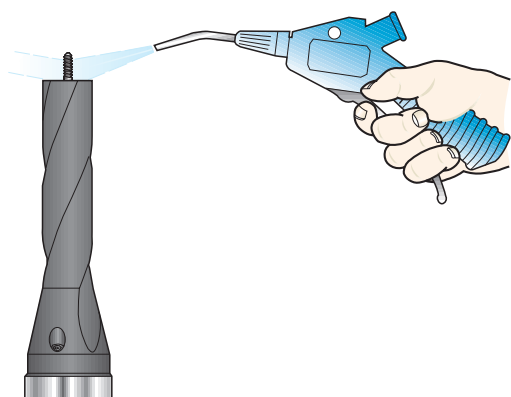

2.

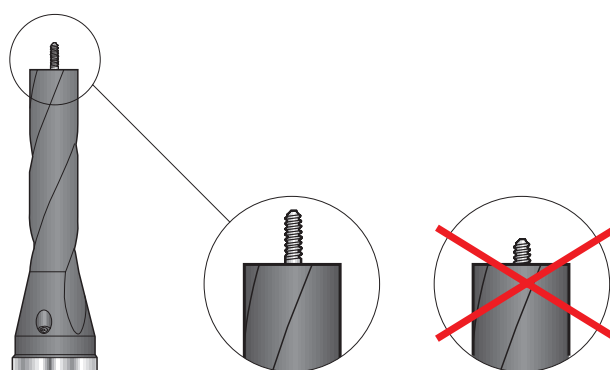

3.

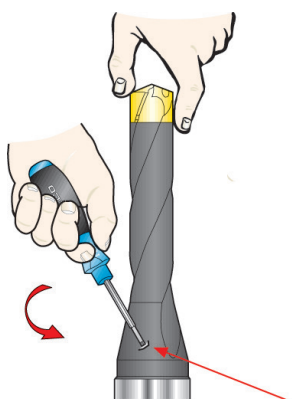

Stacjonarne

Odległość między środkiem wiertła a osią obracającego się detalu nie powinna być większa niż 0,03 mm (0.001") w przypadku pracy jako narzędzie nieobrotowe.

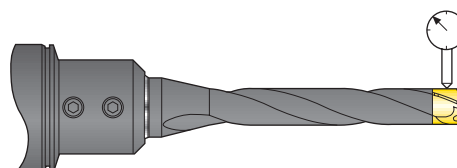

Zalecane oprawki narzędziowe

Dla najlepszych rezultatów zalecamy stosowanie oprawek typu DIN 1835 B/DIN 6535 HB (Weldon). Dodatkowe informacje można znaleźć w katalogu oprawek narzędziowych.



Weldon

Wiertło Ø DC mm	M _c Nm	Wiertło Ø DC cale	M _c in/lbs
10,00-13,99	0,8-1,0	0.394-0.551	7-9
14,00-16,99	1,8-2,2	0.551-0.669	16-19.5
17,00-25,99	2,5-3,0	0.669-1.023	22-26

SD101 – R7

Głębokość wiercenia ~ 1,5 x D – Oprawka metryczna

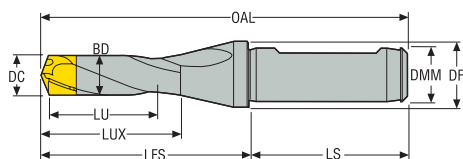

- Chłodzenie wewnętrzne
- ISO9766 do uchwytów: Weldon 1835B, ISO 5414, DIN 60880
- Parametry skrawania, patrz strona (strony) 191

Oznaczenie	Numer produktu	DC	LU	OAL	LUX	BD	LFS	LS	DMM	DF
		mm	mm	mm	mm	mm	mm	mm	mm	mm
SD101-12.00/12.49-20-16R7	02445790	12,0-12,49	20,0	96,0	32,0	11,5	48,0	48,0	16,0	20,0
SD101-12.50/12.99-20-16R7	02445791	12,5-12,99	20,0	96,4	32,4	12,0	48,4	48,0	16,0	20,0
SD101-13.00/13.99-20-16R7	02445792	13,0-13,99	20,0	96,8	32,8	12,5	48,8	48,0	16,0	20,0
SD101-14.00/14.99-25-16R7	02445793	14,0-14,99	25,0	102,4	38,4	13,5	54,4	48,0	16,0	20,0
SD101-15.00/15.99-25-16R7	02445794	15,0-15,99	25,0	103,3	39,3	14,5	55,3	48,0	16,0	20,0
SD101-16.00/16.99-25-16R7	02445795	16,0-16,99	25,0	104,0	40,0	15,5	56,0	48,0	16,0	20,0
SD101-17.00/17.99-30-20R7	02445796	17,0-17,99	30,0	110,7	44,7	16,5	60,7	50,0	20,0	25,0
SD101-18.00/18.99-30-20R7	02445797	18,0-18,99	30,0	111,7	45,7	17,5	61,7	50,0	20,0	25,0
SD101-19.00/19.99-30-20R7	02445798	19,0-19,99	30,0	112,5	46,5	18,5	62,5	50,0	20,0	25,0
SD101-20.00/21.99-40-25R7	02462832	20,0-21,99	40,0	129,5	53,5	19,5	73,5	56,0	25,0	31,0
SD101-22.00/23.99-40-25R7	02462833	22,0-23,99	40,0	129,5	53,5	21,5	73,5	56,0	25,0	31,0
SD101-24.00/25.99-40-25R7	02462834	24,0-25,99	40,0	129,5	53,5	23,5	73,5	56,0	25,0	31,0

Części zamienne, zawarte w dostawie

Dla śred. wiertła (mm)	Klucz mocujący	Śruba mocująca	Zestaw części zamiennych
12,00-13,99	H1.5-2D	MP6SS3X12	SD101-SP-5.0
14,00-16,99	H2.0-2D	MP6SS4X12	SD101-SP-6.0
17,00-19,99	H2.5-2D	MP6SS5X16	SD101-SP-7.0
20,00-25,99	H2.5-2D	MP6SS5X16	SD101-SP-8.0

Akcesoria

Wkładka do wymiany	Klucz dynamometryczny
H00-1.5	H00-1509
H00-2.0	H00-2020
H00-2.5	H00-2530
H00-2.5	H00-2535

SD101 – R7

Głębokość wiercenia ~ 1,5 x D – Chwyty calowy

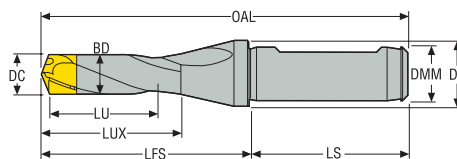

- Chłodzenie wewnętrzne
- ISO9766 do uchwytów: Weldon 1835B, ISO 5414, DIN 60880
- Parametry skrawania, patrz strona (strony) 191

Oznaczenie	Numer produktu	DC	LU	BD	DF	OAL	LS	LFS	LUX	DMM
		Cal.	Cal.	Cal.	Cal.	Cal.	Cal.	Cal.	Cal.	Cal.
SD101-12.00/12.49-20-0625R7	02445817	0.472-0.492	0.787	0.453	0.787	3.780	1.890	1.890	1.260	0.625
SD101-12.50/12.99-20-0625R7	02445818	0.492-0.511	0.787	0.472	0.787	3.795	1.890	1.906	1.276	0.625
SD101-13.00/13.99-20-0625R7	02445819	0.512-0.551	0.787	0.492	0.787	3.811	1.890	1.921	1.291	0.625
SD101-14.00/14.99-25-0625R7	02445820	0.551-0.590	0.984	0.531	0.787	4.031	1.890	2.142	1.512	0.625
SD101-15.00/15.99-25-0625R7	02445821	0.591-0.630	0.984	0.571	0.787	4.067	1.890	2.177	1.547	0.625
SD101-16.00/16.99-25-0625R7	02445822	0.630-0.669	0.984	0.610	0.787	4.094	1.890	2.205	1.575	0.625
SD101-17.00/17.99-30-0750R7	02445823	0.669-0.708	1.181	0.650	0.984	4.358	1.969	2.390	1.760	0.750
SD101-18.00/18.99-30-0750R7	02445824	0.709-0.748	1.181	0.689	0.984	4.398	1.969	2.429	1.799	0.750
SD101-19.00/19.99-30-0750R7	02445825	0.748-0.787	1.181	0.728	0.984	4.429	1.969	2.461	1.831	0.750
SD101-20.00/21.99-40-1000R7	02466044	0.787-0.866	1.575	0.768	1.220	5.098	2.205	2.894	2.106	1.000
SD101-22.00/23.99-40-1000R7	02466045	0.866-0.944	1.575	0.846	1.220	5.098	2.205	2.894	2.106	1.000
SD101-24.00/25.99-40-1000R7	02466046	0.945-1.023	1.575	0.925	1.220	5.098	2.205	2.894	2.106	1.000

Części zamienne, zawarte w dostawie

Dla śred. wiertła (cale)	Klucz mocujący	Śruba mocująca	Zestaw części zamiennych
0.472-0.551	H1.5-2D	MP6SS3X12	SD101-SP-5.0
0.551-0.669	H2.0-2D	MP6SS4X12	SD101-SP-6.0
0.669-0.787	H2.5-2D	MP6SS5X16	SD101-SP-7.0
0.787-1.023	H2.5-2D	MP6SS5X16	SD101-SP-8.0

Akcesoria

Wkładka do wymiany	Klucz dynamometryczny
H00-1.5	H00-1509
H00-2.0	H00-2020
H00-2.5	H00-2530
H00-2.5	H00-2535

SD103 – R7

Głębokość wiercenia ~ 3 x D – Oprawka metryczna

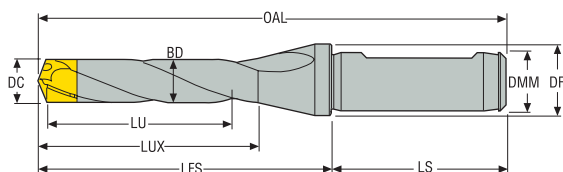

- Chłodzenie wewnętrzne
- ISO9766 do uchwytów: Weldon 1835B, ISO 5414, DIN 60880
- Parametry skrawania, patrz strona (strony) 192

Oznaczenie	Numer produktu	DC	LU	OAL	LUX	BD	LFS	LS	DMM	DF
		mm	mm	mm	mm	mm	mm	mm	mm	mm
SD103-10.00/10.49-30-16R7	02462815	10,0-10,49	30,0	101,0	38,0	9,5	53,0	48,0	16,0	20,0
SD103-10.50/10.99-30-16R7	02462818	10,5-10,99	30,0	101,0	38,0	10,0	53,0	48,0	16,0	20,0
SD103-11.00/11.49-30-16R7	02462819	11,0-11,49	30,0	101,0	38,0	10,5	53,0	48,0	16,0	20,0
SD103-11.50/11.99-30-16R7	02462820	11,5-11,99	30,0	101,0	38,0	11,0	53,0	48,0	16,0	20,0
SD103-12.00/12.49-40-16R7	02445799	12,0-12,49	40,0	116,0	48,0	11,5	68,0	48,0	16,0	20,0
SD103-12.50/12.99-40-16R7	02445800	12,5-12,99	40,0	116,4	48,4	12,0	68,4	48,0	16,0	20,0
SD103-13.00/13.99-40-16R7	02445801	13,0-13,99	40,0	116,8	48,8	12,5	68,8	48,0	16,0	20,0
SD103-14.00/14.99-50-16R7	02445802	14,0-14,99	50,0	127,4	59,4	13,5	79,4	48,0	16,0	20,0
SD103-15.00/15.99-50-16R7	02445803	15,0-15,99	50,0	128,3	60,3	14,5	80,3	48,0	16,0	20,0
SD103-16.00/16.99-50-16R7	02445804	16,0-16,99	50,0	129,0	61,0	15,5	81,0	48,0	16,0	20,0
SD103-17.00/17.99-60-20R7	02445805	17,0-17,99	60,0	140,7	67,7	16,5	90,7	50,0	20,0	25,0
SD103-18.00/18.99-60-20R7	02445806	18,0-18,99	60,0	141,7	68,7	17,5	91,7	50,0	20,0	25,0
SD103-19.00/19.99-60-20R7	02445807	19,0-19,99	60,0	142,5	69,5	18,5	92,7	50,0	20,0	25,0
SD103-20.00/21.99-75-25R7	02462836	20,0-21,99	75,0	164,5	88,5	19,5	108,5	56,0	25,0	31,0
SD103-22.00/23.99-75-25R7	02462838	22,0-23,99	75,0	164,5	88,5	21,5	108,5	56,0	25,0	31,0
SD103-24.00/25.99-75-25R7	02462841	24,0-25,99	75,0	164,5	88,5	23,5	108,5	56,0	25,0	31,0

Części zamienne, zawarte w dostawie

Dla śred. wiertła (mm)	Klucz mocujący	Śruba mocująca	Zestaw części zamiennych
10,00-11,99	H1.5-2D	MP6SS3X12	SD103-SP-4.0
12,00-13,99	H1.5-2D	MP6SS3X12	SD103-SP-5.0
14,00-16,99	H2.0-2D	MP6SS4X12	SD103-SP-6.0
17,00-19,99	H2.5-2D	MP6SS5X16	SD103-SP-7.0
20,00-25,99	H2.5-2D	MP6SS5X16	SD103-SP-8.0

Akcesoria

Wkładka do wymiany	Klucz dynamometryczny
H00-1.5	H00-1509
H00-1.5	H00-1509
H00-2.0	H00-2020
H00-2.5	H00-2530
H00-2.5	H00-2535

SD103 – R7

Głębokość wiercenia ~ 3 x D – Chwył calowy

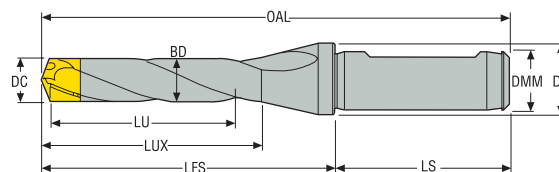

- Chłodzenie wewnętrzne
- ISO9766 do uchwytów: Weldon 1835B, ISO 5414, DIN 60880
- Parametry skrawania, patrz strona (strony) 192

Oznaczenie	Numer produktu	DC	LU	BD	DF	OAL	LS	LFS	LUX	DMM
		Cal.	Cal.	Cal.	Cal.	Cal.	Cal.	Cal.	Cal.	Cal.
SD103-09.50/09.99-30-0625R7	02673828	0.374-0.393	1.181	0.354	0.787	4.252	1.969	2.323	1.835	0.625
SD103-10.00/10.49-30-0625R7	02466011	0.394-0.413	1.181	0.374	0.787	3.976	1.890	2.087	1.496	0.625
SD103-10.50/10.99-30-0625R7	02466012	0.413-0.433	1.181	0.394	0.787	3.976	1.890	2.087	1.496	0.625
SD103-11.00/11.49-30-0625R7	02466013	0.433-0.452	1.181	0.413	0.787	3.976	1.890	2.087	1.496	0.625
SD103-11.50/11.99-30-0625R7	02466014	0.453-0.472	1.181	0.433	0.787	3.976	1.890	2.087	1.496	0.625
SD103-12.00/12.49-40-0625R7	02445826	0.472-0.492	1.575	0.453	0.787	4.567	1.890	2.677	1.890	0.625
SD103-12.50/12.99-40-0625R7	02445827	0.492-0.511	1.575	0.472	0.787	4.583	1.890	2.693	1.906	0.625
SD103-13.00/13.99-40-0625R7	02445828	0.512-0.551	1.575	0.492	0.787	4.598	1.890	2.709	1.921	0.625
SD103-14.00/14.99-50-0625R7	02445829	0.551-0.590	1.969	0.531	0.787	5.016	1.890	3.126	2.339	0.625
SD103-15.00/15.99-50-0625R7	02445830	0.591-0.630	1.969	0.571	0.787	5.051	1.890	3.161	2.374	0.625
SD103-16.00/16.99-50-0625R7	02445831	0.630-0.669	1.969	0.610	0.787	5.079	1.890	3.189	2.402	0.625
SD103-17.00/17.99-60-0750R7	02445832	0.669-0.708	2.362	0.650	0.984	5.539	1.969	3.571	2.665	0.750
SD103-18.00/18.99-60-0750R7	02445833	0.709-0.748	2.362	0.689	0.984	5.579	1.969	3.610	2.705	0.750
SD103-19.00/19.99-60-0750R7	02445834	0.748-0.787	2.362	0.728	0.984	5.610	1.969	3.650	2.736	0.750
SD103-20.00/21.99-75-1000R7	02466049	0.787-0.866	2.953	0.768	1.220	6.476	2.205	4.272	3.484	1.000
SD103-22.00/23.99-75-1000R7	02466050	0.866-0.944	2.953	0.846	1.220	6.476	2.205	4.272	3.484	1.000
SD103-24.00/25.99-75-1000R7	02466051	0.945-1.023	2.953	0.925	1.220	6.476	2.205	4.272	3.484	1.000

Części zamienne, zawarte w dostawie

Dla śred. wiertła (cale)	Klucz mocujący	Śruba mocująca	Zestaw części zamiennych
0.374-0.393	H1.5-2D	MP6SS3X12	–
0.394-0.472	H1.5-2D	MP6SS3X12	SD103-SP-4.0
0.472-0.551	H1.5-2D	MP6SS3X12	SD103-SP-5.0
0.551-0.669	H2.0-2D	MP6SS4X12	SD103-SP-6.0
0.669-0.787	H2.5-2D	MP6SS5X16	SD103-SP-7.0
0.787-1.023	H2.5-2D	MP6SS5X16	SD103-SP-8.0

Akcesoria

Wkładka do wymiany	Klucz dynamometryczny
H00-1.5	H00-1509
H00-1.5	H00-1509
H00-1.5	H00-1509
H00-2.0	H00-2020
H00-2.5	H00-2530
H00-2.5	H00-2535

SD105 – R7

Głębokość wiercenia ~ 5 x D – Oprawka metryczna

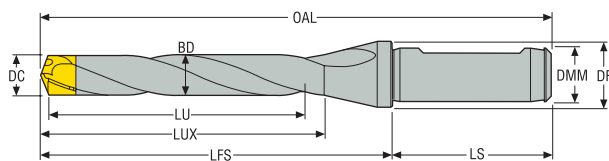

- Chłodzenie wewnętrzne
- ISO9766 do uchwytów: Weldon 1835B, ISO 5414, DIN 60880
- Parametry skrawania, patrz strona (strony) 193

Oznaczenie	Numer produktu	DC	LU	OAL	LUX	BD	LFS	LS	DMM	DF
		mm	mm	mm	mm	mm	mm	mm	mm	mm
SD105-10.00/10.49-50-16R7	02462822	10,0-10,49	50,0	120,1	57,3	9,5	72,1	48,0	16,0	20,0
SD105-10.50/10.99-50-16R7	02462824	10,5-10,99	50,0	120,6	57,3	10,0	72,6	48,0	16,0	20,0
SD105-11.00/11.49-50-16R7	02462828	11,0-11,49	50,0	120,9	57,3	10,5	72,9	48,0	16,0	20,0
SD105-11.50/11.99-50-16R7	02462830	11,5-11,99	50,0	121,3	58,3	11,0	73,3	48,0	16,0	20,0
SD105-12.00/12.49-65-16R7	02445808	12,0-12,49	65,0	141,0	73,0	11,5	93,0	48,0	16,0	20,0
SD105-12.50/12.99-65-16R7	02445809	12,5-12,99	65,0	141,4	73,4	12,0	93,4	48,0	16,0	20,0
SD105-13.00/13.99-65-16R7	02445810	13,0-13,99	65,0	141,8	73,8	12,5	93,8	48,0	16,0	20,0
SD105-14.00/14.99-80-16R7	02445811	14,0-14,99	80,0	157,4	89,4	13,5	109,4	48,0	16,0	20,0
SD105-15.00/15.99-80-16R7	02445812	15,0-15,99	80,0	158,3	90,3	14,5	110,3	48,0	16,0	20,0
SD105-16.00/16.99-80-16R7	02445813	16,0-16,99	80,0	159,0	91,0	15,5	111,0	48,0	16,0	20,0
SD105-17.00/17.99-95-20R7	02445814	17,0-17,99	95,0	176,7	107,7	16,5	126,7	50,0	20,0	25,0
SD105-18.00/18.99-95-20R7	02445815	18,0-18,99	95,0	177,7	108,7	17,5	127,7	50,0	20,0	25,0
SD105-19.00/19.99-95-20R7	02445816	19,0-19,99	95,0	178,5	109,5	18,5	128,5	50,0	20,0	25,0
SD105-20.00/21.99-125-25R7	02462843	20,0-21,99	125,0	214,5	138,5	19,5	158,5	56,0	25,0	31,0
SD105-22.00/23.99-125-25R7	02462848	22,0-23,99	125,0	214,5	138,5	21,5	158,5	56,0	25,0	31,0
SD105-24.00/25.99-125-25R7	02462850	24,0-25,99	125,0	214,5	138,5	23,5	158,5	56,0	25,0	31,0

Części zamienne, zawarte w dostawie

Dla śred. wiertła (mm)	Klucz mocujący	Śruba mocująca	Zestaw części zamiennych
10,00-11,99	H1.5-2D	MP6SS3X12	SD105-SP-4.0
12,00-13,99	H1.5-2D	MP6SS3X12	SD105-SP-5.0
14,00-16,99	H2.0-2D	MP6SS4X12	SD105-SP-6.0
17,00-19,99	H2.5-2D	MP6SS5X16	SD105-SP-7.0
20,00-25,99	H2.5-2D	MP6SS5X16	SD105-SP-8.0

Akcesoria

Wkładka do wymiany	Klucz dynamometryczny
H00-1.5	H00-1509
H00-1.5	H00-1509
H00-2.0	H00-2020
H00-2.5	H00-2530
H00-2.5	H00-2535

SD105 – R7

Głębokość wiercenia ~ 5 x D – Chwył calowy

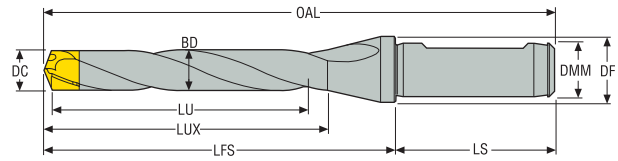

- Chłodzenie wewnętrzne
- ISO9766 do uchwytów: Weldon 1835B, ISO 5414, DIN 60880
- Parametry skrawania, patrz strona (strony) 193

Oznaczenie	Numer produktu	DC	LU	BD	DF	OAL	LS	LFS	LUX	DMM
		Cal.	Cal.	Cal.	Cal.	Cal.	Cal.	Cal.	Cal.	Cal.
SD105-10.00/10.49-50-0625R7	02466034	0.394-0.413	1.969	0.374	0.787	4.728	1.890	2.839	2.256	0.625
SD105-10.50/10.99-50-0625R7	02466037	0.413-0.433	1.969	0.394	0.787	4.748	1.890	2.858	2.256	0.625
SD105-11.00/11.49-50-0625R7	02466041	0.433-0.452	1.969	0.413	0.787	4.760	1.890	2.870	2.256	0.625
SD105-11.50/11.99-50-0625R7	02466042	0.453-0.472	1.969	0.433	0.787	4.776	1.890	2.886	2.295	0.625
SD105-12.00/12.49-65-0625R7	02445835	0.472-0.492	2.559	0.453	0.787	5.551	1.890	3.661	2.874	0.625
SD105-12.50/12.99-65-0625R7	02445836	0.492-0.511	2.559	0.472	0.787	5.567	1.890	3.677	2.890	0.625
SD105-13.00/13.99-65-0625R7	02445837	0.512-0.551	2.559	0.492	0.787	5.583	1.890	3.693	2.906	0.625
SD105-14.00/14.99-80-0625R7	02445838	0.551-0.590	3.150	0.531	0.787	6.197	1.890	4.307	3.520	0.625
SD105-15.00/15.99-80-0625R7	02445839	0.591-0.630	3.150	0.571	0.787	6.232	1.890	4.343	3.555	0.625
SD105-16.00/16.99-80-0625R7	02445840	0.630-0.669	3.150	0.610	0.787	6.260	1.890	4.370	3.583	0.625
SD105-17.00/17.99-95-0750R7	02445841	0.669-0.708	3.740	0.650	0.984	6.957	1.969	4.988	4.240	0.750
SD105-18.00/18.99-95-0750R7	02445842	0.709-0.748	3.740	0.689	0.984	6.996	1.969	5.028	4.280	0.750
SD105-19.00/19.99-95-0750R7	02445843	0.748-0.787	3.740	0.728	0.984	7.028	1.969	5.059	4.311	0.750
SD105-20.00/21.99-125-1000R7	02466052	0.787-0.866	4.921	0.768	1.220	8.445	2.205	6.240	5.453	1.000
SD105-22.00/23.99-125-1000R7	02466053	0.866-0.944	4.921	0.846	1.220	8.445	2.205	6.240	5.453	1.000
SD105-24.00/25.99-125-1000R7	02466054	0.945-1.023	4.921	0.925	1.220	8.445	2.205	6.240	5.453	1.000

Części zamienne, zawarte w dostawie

Dla śred. wiertła (cale)	Klucz mocujący	Śruba mocująca	Zestaw części zamiennych
0.394-0.472	H1.5-2D	MP6SS3X12	SD105-SP-4.0
0.472-0.551	H1.5-2D	MP6SS3X12	SD105-SP-5.0
0.551-0.669	H2.0-2D	MP6SS4X12	SD105-SP-6.0
0.669-0.787	H2.5-2D	MP6SS5X16	SD105-SP-7.0
0.787-1.023	H2.5-2D	MP6SS5X16	SD105-SP-8.0

Akcesoria

Wkładka do wymiany	Klucz dynamometryczny
H00-1.5	H00-1509
H00-1.5	H00-1509
H00-2.0	H00-2020
H00-2.5	H00-2530
H00-2.5	H00-2535

SD107 – R7

Głębokość wiercenia ~ 7 x D – Oprawka metryczna

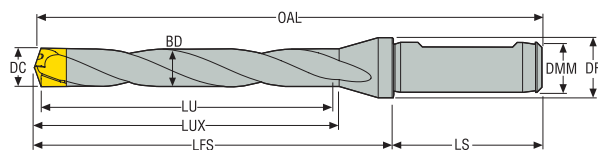

- Chłodzenie wewnętrzne
- ISO9766 do uchwytów: Weldon 1835B, ISO 5414, DIN 60880
- Parametry skrawania, patrz strona (strony) 194

Oznaczenie	Numer produktu	DC	LU	OAL	LUX	BD	LFS	LS	DMM	DF
		mm	mm	mm	mm	mm	mm	mm	mm	mm
SD107-12.00/12.49-90-16R7	02427470	12,0-12,49	90,0	166,5	100,5	11,5	118,5	48,0	16,0	20,0
SD107-12.50/12.99-90-16R7	02427472	12,5-12,99	90,0	167,0	101,0	12,0	119,0	48,0	16,0	20,0
SD107-13.00/13.99-90-16R7	02427473	13,0-13,99	90,0	167,5	101,5	12,5	119,5	48,0	16,0	20,0
SD107-14.00/14.99-110-16R7	02427474	14,0-14,99	110,0	188,0	122,0	13,5	140,0	48,0	16,0	20,0
SD107-15.00/15.99-110-16R7	02427476	15,0-15,99	110,0	189,0	123,0	14,5	141,0	48,0	16,0	20,0
SD107-16.00/16.99-110-16R7	02427443	16,0-16,99	110,0	189,5	123,5	15,5	141,5	48,0	16,0	20,0
SD107-17.00/17.99-130-20R7	02427478	17,0-17,99	130,0	212,5	144,5	16,5	162,5	50,0	20,0	25,0
SD107-18.00/18.99-130-20R7	02427479	18,0-18,99	130,0	213,5	145,5	17,5	163,5	50,0	20,0	25,0
SD107-19.00/19.99-130-20R7	02427480	19,0-19,99	130,0	214,5	146,5	18,5	164,5	50,0	20,0	25,0
SD107-20.00/21.99-175-25R7	02530422	20,0-21,99	175,0	264,5	188,5	19,5	208,5	56,0	25,0	31,0
SD107-22.00/23.99-175-25R7	02530423	22,0-23,99	175,0	264,5	188,5	21,5	208,5	56,0	25,0	31,0
SD107-24.00/25.99-175-25R7	02517867	24,0-25,99	175,0	264,5	188,5	23,5	208,5	56,0	25,0	31,0

Części zamienne, zawarte w dostawie

Dla śred. wiertła (mm)	Klucz mocujący	Śruba mocująca	Zestaw części zamiennych
12,00-13,99	H1.5-2D	MP6SS3X12	SD107-SP-5.0
14,00-16,99	H2.0-2D	MP6SS4X12	SD107-SP-6.0
17,00-19,99	H2.5-2D	MP6SS5X16	SD107-SP-7.0
20,00-25,99	H2.5-2D	MP6SS5X16	SD107-SP-8.0

Akcesoria

Wkładka do wymiany	Klucz dynamometryczny
H00-1.5	H00-1509
H00-2.0	H00-2020
H00-2.5	H00-2530
H00-2.5	H00-2535

SD107 – R7

Głębokość wiercenia ~ 7 x D – Chwył calowy

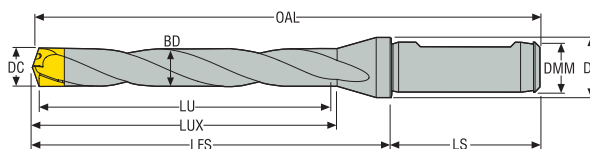

- Chłodzenie wewnętrzne
- ISO9766 do uchwytów: Weldon 1835B, ISO 5414, DIN 60880
- Parametry skrawania, patrz strona (strony) 194

Oznaczenie	Numer produktu	DC	LU	BD	DF	OAL	LS	LFS	LUX	DMM
		Cal.	Cal.	Cal.	Cal.	Cal.	Cal.	Cal.	Cal.	Cal.
SD107-12.00/12.49-90-0625R7	00040003	0.472-0.492	3.543	0.453	0.787	6.555	1.890	4.665	3.957	0.625
SD107-12.50/12.99-90-0625R7	00040004	0.492-0.511	3.543	0.472	0.787	6.575	1.890	4.685	3.976	0.625
SD107-13.00/13.99-90-0625R7	00040005	0.512-0.551	3.543	0.492	0.787	6.594	1.890	4.705	3.996	0.625
SD107-14.00/14.99-110-0625R7	00040006	0.551-0.590	4.331	0.531	0.787	7.402	1.890	5.512	4.803	0.625
SD107-15.00/15.99-110-0625R7	00040007	0.591-0.630	4.331	0.571	0.787	7.441	1.890	5.551	4.843	0.625
SD107-16.00/16.99-110-0625R7	00040008	0.630-0.669	4.331	0.610	0.787	7.461	1.890	5.571	4.862	0.625
SD107-17.00/17.99-130-0750R7	00040009	0.669-0.708	5.118	0.650	0.984	8.366	1.969	6.398	5.689	0.750
SD107-18.00/18.99-130-0750R7	00040010	0.709-0.748	5.118	0.689	0.984	8.406	1.969	6.437	5.728	0.750
SD107-19.00/19.99-130-0750R7	00040011	0.748-0.787	5.118	0.728	0.984	8.445	1.969	6.476	5.768	0.750
SD107-20.00/21.99-175-1000R7	02529095	0.787-0.866	6.890	0.768	1.220	10.413	2.205	8.209	7.421	1.000
SD107-22.00/23.99-175-1000R7	02530424	0.866-0.944	6.890	0.846	1.220	10.413	2.205	8.209	7.421	1.000
SD107-24.00/25.99-175-1000R7	02530425	0.945-1.023	6.890	0.925	1.220	10.413	2.205	8.209	7.421	1.000

Części zamienne, zawarte w dostawie

Dla śred. wiertła (cale)	Klucz mocujący	Śruba mocująca	Zestaw części zamiennych
0.472-0.551	H1.5-2D	MP6SS3X12	SD107-SP-5.0
0.551-0.669	H2.0-2D	MP6SS4X12	SD107-SP-6.0
0.669-0.787	H2.5-2D	MP6SS5X16	SD107-SP-7.0
0.787-1.023	H2.5-2D	MP6SS5X16	SD107-SP-8.0

Akcesoria

Dla śred. wiertła (cale)	Wkładka do wymiany	Klucz dynamometryczny
0.472-0.551	H00-1.5	H00-1509
0.551-0.669	H00-2.0	H00-2020
0.669-0.787	H00-2.5	H00-2530
0.787-1.023	H00-2.5	H00-2535

Końcówki – Geometria -P, -M i -K

Kąt wierzchołkowy 140°

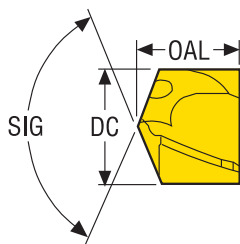

Oznaczenie	Numer produktu	Geometria P	Geometria M	Geometria K	DC		OAL	
					mm	cal.	mm	cal.
SD100-9.52-M	02700334	-	■	-	9,52	0.375	8,08	0.318
SD100-9.52-P	02673829	■	-	-	9,52	0.375	8,08	0.318
SD100-10.00-M	02469072	-	■	-	10,0	0.394	8,1	0.319
SD100-10.00-P	02469022	■	-	-	10,0	0.394	8,1	0.319
SD100-10.10-P	02469024	■	-	-	10,1	0.398	8,1	0.319
SD100-10.20-K	02544440	-	-	■	10,2	0.402	8,1	0.319
SD100-10.20-M	02469074	-	■	-	10,2	0.402	8,1	0.319
SD100-10.20-P	02469025	■	-	-	10,2	0.402	8,1	0.319
SD100-10.30-P	02469026	■	-	-	10,3	0.406	8,1	0.319
SD100-10.319-M	02469075	-	■	-	10,319	0.406	8,1	0.319
SD100-10.319-P	02469027	■	-	-	10,319	0.406	8,1	0.319
SD100-10.40-P	02592734	■	-	-	10,4	0.409	8,1	0.319
SD100-10.50-K	02556726	-	-	■	10,5	0.413	8,5	0.335
SD100-10.50-M	02469076	-	■	-	10,5	0.413	8,5	0.335
SD100-10.50-P	02469034	■	-	-	10,5	0.413	8,5	0.335
SD100-10.70-P	02469036	■	-	-	10,7	0.421	8,5	0.335
SD100-10.716-P	02469037	■	-	-	10,716	0.422	8,5	0.335
SD100-10.80-M	02469078	-	■	-	10,8	0.425	8,5	0.335
SD100-10.80-P	02469038	■	-	-	10,8	0.425	8,5	0.335
SD100-10.90-P	02469041	■	-	-	10,9	0.429	8,5	0.335
SD100-11.00-M	02469079	-	■	-	11,0	0.433	8,8	0.346
SD100-11.00-P	02469052	■	-	-	11,0	0.433	8,8	0.346
SD100-11.113-M	02469080	-	■	-	11,113	0.438	8,8	0.346
SD100-11.113-P	02469056	■	-	-	11,113	0.438	8,8	0.346
SD100-11.20-M	02469082	-	■	-	11,2	0.441	8,8	0.346
SD100-11.20-P	02469058	■	-	-	11,2	0.441	8,8	0.346
SD100-11.30-P	02469063	■	-	-	11,3	0.445	8,8	0.346
SD100-11.50-P	02469065	■	-	-	11,5	0.453	9,4	0.370
SD100-11.509-M	02469083	-	■	-	11,509	0.453	9,4	0.370
SD100-11.509-P	02469067	■	-	-	11,509	0.453	9,4	0.370
SD100-11.70-P	02469068	■	-	-	11,7	0.461	9,4	0.370
SD100-11.80-K	02542583	-	-	■	11,8	0.465	9,4	0.370
SD100-11.80-M	02469085	-	■	-	11,8	0.465	9,4	0.370
SD100-11.80-P	02469069	■	-	-	11,8	0.465	9,4	0.370
SD100-11.907-M	02592744	-	■	-	11,907	0.469	9,4	0.370
SD100-11.907-P	02469070	■	-	-	11,907	0.469	9,4	0.370
SD100-12.00-K	00090316	-	-	■	12,0	0.472	9,6	0.378
SD100-12.00-M	00090315	-	■	-	12,0	0.472	9,6	0.378

Oznaczenie	Numer produktu	Geometria P	Geometria M	Geometria K	DC		OAL	
					mm	cal.	mm	cal.
SD100-12.00-P	00090314	■	-	-	12,0	0.472	9,6	0.378
SD100-12.10-P	00039002	■	-	-	12,1	0.476	9,6	0.378
SD100-12.20-P	00048248	■	-	-	12,2	0.480	9,6	0.378
SD100-12.30-M	00071559	-	■	-	12,3	0.484	9,6	0.378
SD100-12.30-P	00071546	■	-	-	12,3	0.484	9,6	0.378
SD100-12.41-M	00059768	-	■	-	12,41	0.489	9,6	0.378
SD100-12.41-P	00059767	■	-	-	12,41	0.489	9,6	0.378
SD100-12.50-K	00090319	-	-	■	12,5	0.492	10,0	0.394
SD100-12.50-M	00090318	-	■	-	12,5	0.492	10,0	0.394
SD100-12.50-P	00090317	■	-	-	12,5	0.492	10,0	0.394
SD100-12.60-P	02207212	■	-	-	12,6	0.496	10,0	0.394
SD100-12.70-K	00059633	-	-	■	12,7	0.500	10,0	0.394
SD100-12.70-M	00059632	-	■	-	12,7	0.500	10,0	0.394
SD100-12.70-P	00059631	■	-	-	12,7	0.500	10,0	0.394
SD100-12.80-K	00059636	-	-	■	12,8	0.504	10,0	0.394
SD100-12.80-M	00059635	-	■	-	12,8	0.504	10,0	0.394
SD100-12.80-P	00059634	■	-	-	12,8	0.504	10,0	0.394
SD100-12.90-M	02503935	-	■	-	12,9	0.508	10,0	0.394
SD100-12.90-P	00030891	■	-	-	12,9	0.508	10,0	0.394
SD100-13.00-K	00098529	-	-	■	13,0	0.512	10,4	0.409
SD100-13.00-M	00098528	-	■	-	13,0	0.512	10,4	0.409
SD100-13.00-P	00098527	■	-	-	13,0	0.512	10,4	0.409
SD100-13.10-K	00059639	-	-	■	13,1	0.516	10,4	0.409
SD100-13.10-M	00059638	-	■	-	13,1	0.516	10,4	0.409
SD100-13.10-P	00059637	■	-	-	13,1	0.516	10,4	0.409
SD100-13.20-P	00030894	■	-	-	13,2	0.520	10,4	0.409
SD100-13.30-M	00059641	-	■	-	13,3	0.524	10,4	0.409
SD100-13.30-P	00059640	■	-	-	13,3	0.524	10,4	0.409
SD100-13.50-K	00098532	-	-	■	13,5	0.531	10,4	0.409
SD100-13.50-M	00098531	-	■	-	13,5	0.531	10,4	0.409
SD100-13.50-P	00098530	■	-	-	13,5	0.531	10,4	0.409
SD100-13.70-M	00059644	-	■	-	13,7	0.539	10,4	0.409
SD100-13.70-P	00059643	■	-	-	13,7	0.539	10,4	0.409
SD100-13.80-K	00059648	-	-	■	13,8	0.543	10,4	0.409
SD100-13.80-M	00059647	-	■	-	13,8	0.543	10,4	0.409
SD100-13.80-P	00059646	■	-	-	13,8	0.543	10,4	0.409
SD100-13.89-M	00059771	-	■	-	13,89	0.547	10,4	0.409
SD100-13.89-P	00059770	■	-	-	13,89	0.547	10,4	0.409
SD100-14.00-K	00090322	-	-	■	14,0	0.551	11,0	0.433
SD100-14.00-M	00090321	-	■	-	14,0	0.551	11,0	0.433
SD100-14.00-P	00090320	■	-	-	14,0	0.551	11,0	0.433
SD100-14.10-P	00082712	■	-	-	14,1	0.555	11,0	0.433
SD100-14.20-K	00071549	-	-	■	14,2	0.559	11,0	0.433
SD100-14.20-M	00071561	-	■	-	14,2	0.559	11,0	0.433
SD100-14.20-P	00071548	■	-	-	14,2	0.559	11,0	0.433
SD100-14.29-K	00059675	-	-	■	14,29	0.563	11,0	0.433
SD100-14.29-M	00059674	-	■	-	14,29	0.563	11,0	0.433
SD100-14.29-P	00059673	■	-	-	14,29	0.563	11,0	0.433
SD100-14.40-P	02207869	■	-	-	14,4	0.567	11,0	0.433
SD100-14.50-K	00090325	-	-	■	14,5	0.571	11,0	0.433
SD100-14.50-M	00090324	-	■	-	14,5	0.571	11,0	0.433

Wstęp

Wiercenie

Rozwiercanie

Wytaczanie

Załącznik

Oznaczenie	Numer produktu	Geometria P	Geometria M	Geometria K	DC		OAL	
					mm	cal.	mm	cal.
SD100-14.50-P	00090323	■	-	-	14,5	0.571	11,0	0.433
SD100-14.68-K	00059775	-	-	■	14,68	0.578	11,0	0.433
SD100-14.68-M	00059774	-	■	-	14,68	0.578	11,0	0.433
SD100-14.68-P	00059773	■	-	-	14,68	0.578	11,0	0.433
SD100-14.70-M	00059650	-	■	-	14,7	0.579	11,0	0.433
SD100-14.70-P	00059649	■	-	-	14,7	0.579	11,0	0.433
SD100-14.80-M	00059653	-	■	-	14,8	0.583	11,0	0.433
SD100-14.80-P	00059652	■	-	-	14,8	0.583	11,0	0.433
SD100-14.90-M	02592745	-	■	-	14,9	0.587	11,0	0.433
SD100-14.90-P	00030895	■	-	-	14,9	0.587	11,0	0.433
SD100-15.00-K	00090328	-	-	■	15,0	0.591	11,9	0.469
SD100-15.00-M	00090327	-	■	-	15,0	0.591	11,9	0.469
SD100-15.00-P	00090326	■	-	-	15,0	0.591	11,9	0.469
SD100-15.08-M	00059777	-	■	-	15,08	0.594	11,9	0.469
SD100-15.08-P	00059776	■	-	-	15,08	0.594	11,9	0.469
SD100-15.10-P	00079342	■	-	-	15,1	0.594	11,9	0.469
SD100-15.20-P	00030896	■	-	-	15,2	0.598	11,9	0.469
SD100-15.25-K	00071551	-	-	■	15,25	0.600	11,9	0.469
SD100-15.25-M	00071562	-	■	-	15,25	0.600	11,9	0.469
SD100-15.25-P	00071550	■	-	-	15,25	0.600	11,9	0.469
SD100-15.48-K	00022926	-	-	■	15,48	0.609	11,9	0.469
SD100-15.48-M	00059780	-	■	-	15,48	0.609	11,9	0.469
SD100-15.48-P	00059779	■	-	-	15,48	0.609	11,9	0.469
SD100-15.50-K	00098535	-	-	■	15,5	0.610	11,9	0.469
SD100-15.50-M	00098534	-	■	-	15,5	0.610	11,9	0.469
SD100-15.50-P	00098533	■	-	-	15,5	0.610	11,9	0.469
SD100-15.70-M	00059656	-	■	-	15,7	0.618	11,9	0.469
SD100-15.70-P	00059655	■	-	-	15,7	0.618	11,9	0.469
SD100-15.80-K	00059660	-	-	■	15,8	0.622	11,9	0.469
SD100-15.80-M	00059659	-	■	-	15,8	0.622	11,9	0.469
SD100-15.80-P	00059658	■	-	-	15,8	0.622	11,9	0.469
SD100-15.88-K	00059678	-	-	■	15,88	0.625	11,9	0.469
SD100-15.88-M	00059677	-	■	-	15,88	0.625	11,9	0.469
SD100-15.88-P	00059676	■	-	-	15,88	0.625	11,9	0.469
SD100-16.00-K	00098538	-	-	■	16,0	0.630	12,6	0.496
SD100-16.00-M	00098537	-	■	-	16,0	0.630	12,6	0.496
SD100-16.00-P	00098536	■	-	-	16,0	0.630	12,6	0.496
SD100-16.10-P	00077964	■	-	-	16,1	0.634	12,6	0.496
SD100-16.20-P	00047365	■	-	-	16,2	0.638	12,6	0.496
SD100-16.25-P	00034081	■	-	-	16,25	0.640	12,6	0.496
SD100-16.27-K	00022929	-	-	■	16,27	0.641	12,6	0.496
SD100-16.27-M	00022928	-	■	-	16,27	0.641	12,6	0.496
SD100-16.27-P	00022927	■	-	-	16,27	0.641	12,6	0.496
SD100-16.40-P	02301114	■	-	-	16,4	0.646	12,6	0.496
SD100-16.50-K	00098541	-	-	■	16,5	0.650	12,6	0.496
SD100-16.50-M	00098540	-	■	-	16,5	0.650	12,6	0.496
SD100-16.50-P	00098539	■	-	-	16,5	0.650	12,6	0.496
SD100-16.67-K	00059681	-	-	■	16,67	0.656	12,6	0.496
SD100-16.67-M	00059680	-	■	-	16,67	0.656	12,6	0.496
SD100-16.67-P	00059679	■	-	-	16,67	0.656	12,6	0.496
SD100-16.70-K	00059663	-	-	■	16,7	0.657	12,6	0.496

Wstęp

Wiercenie

Rozwiercanie

Wylaczanie

Załącznik

Oznaczenie	Numer produktu	Geometria P	Geometria M	Geometria K	DC		OAL	
					mm	cal.	mm	cal.
SD100-16.70-M	00059662	-	■	-	16,7	0.657	12,6	0.496
SD100-16.70-P	00059661	■	-	-	16,7	0.657	12,6	0.496
SD100-16.80-K	00059666	-	-	■	16,8	0.661	12,6	0.496
SD100-16.80-M	00059665	-	■	-	16,8	0.661	12,6	0.496
SD100-16.80-P	00059664	■	-	-	16,8	0.661	12,6	0.496
SD100-16.90-M	02593463	-	■	-	16,9	0.665	12,6	0.496
SD100-16.90-P	00030898	■	-	-	16,9	0.665	12,6	0.496
SD100-17.00-K	00090331	-	-	■	17,0	0.669	13,3	0.524
SD100-17.00-M	00090330	-	■	-	17,0	0.669	13,3	0.524
SD100-17.00-P	00090329	■	-	-	17,0	0.669	13,3	0.524
SD100-17.07-K	00022933	-	-	■	17,07	0.672	13,3	0.524
SD100-17.07-M	00022932	-	■	-	17,07	0.672	13,3	0.524
SD100-17.07-P	00022931	■	-	-	17,07	0.672	13,3	0.524
SD100-17.10-P	00034083	■	-	-	17,1	0.673	13,3	0.524
SD100-17.20-K	02515762	-	-	■	17,2	0.677	13,3	0.524
SD100-17.20-P	00047714	■	-	-	17,2	0.677	13,3	0.524
SD100-17.30-K	02203711	-	-	■	17,3	0.681	13,3	0.524
SD100-17.46-M	00059683	-	■	-	17,46	0.687	13,3	0.524
SD100-17.46-P	00059682	■	-	-	17,46	0.687	13,3	0.524
SD100-17.50-K	00090334	-	-	■	17,5	0.689	13,3	0.524
SD100-17.50-M	00090333	-	■	-	17,5	0.689	13,3	0.524
SD100-17.50-P	00090332	■	-	-	17,5	0.689	13,3	0.524
SD100-17.70-K	00059669	-	-	■	17,7	0.697	13,3	0.524
SD100-17.70-M	00059668	-	■	-	17,7	0.697	13,3	0.524
SD100-17.70-P	00059667	■	-	-	17,7	0.697	13,3	0.524
SD100-17.80-K	00059672	-	-	■	17,8	0.701	13,3	0.524
SD100-17.80-M	00059671	-	■	-	17,8	0.701	13,3	0.524
SD100-17.80-P	00059670	■	-	-	17,8	0.701	13,3	0.524
SD100-17.86-K	00022936	-	-	■	17,86	0.703	13,3	0.524
SD100-17.86-M	00022935	-	■	-	17,86	0.703	13,3	0.524
SD100-17.86-P	00022934	■	-	-	17,86	0.703	13,3	0.524
SD100-17.90-M	02442098	-	■	-	17,9	0.705	13,3	0.524
SD100-17.90-P	00047693	■	-	-	17,9	0.705	13,3	0.524
SD100-18.00-K	00090337	-	-	■	18,0	0.709	14,4	0.567
SD100-18.00-M	00090336	-	■	-	18,0	0.709	14,4	0.567
SD100-18.00-P	00090335	■	-	-	18,0	0.709	14,4	0.567
SD100-18.10-P	00030900	■	-	-	18,1	0.713	14,4	0.567
SD100-18.20-P	00038469	■	-	-	18,2	0.717	14,4	0.567
SD100-18.26-K	00035196	-	-	■	18,26	0.719	14,4	0.567
SD100-18.26-M	00022938	-	■	-	18,26	0.719	14,4	0.567
SD100-18.26-P	00022937	■	-	-	18,26	0.719	14,4	0.567
SD100-18.50-K	00059687	-	-	■	18,5	0.728	14,4	0.567
SD100-18.50-M	00059686	-	■	-	18,5	0.728	14,4	0.567
SD100-18.50-P	00059685	■	-	-	18,5	0.728	14,4	0.567
SD100-18.65-M	00035198	-	■	-	18,65	0.734	14,4	0.567
SD100-18.65-P	00035197	■	-	-	18,65	0.734	14,4	0.567
SD100-18.70-M	00059689	-	■	-	18,7	0.736	14,4	0.567
SD100-18.70-P	00059688	■	-	-	18,7	0.736	14,4	0.567
SD100-18.80-K	00059693	-	-	■	18,8	0.740	14,4	0.567
SD100-18.80-M	00059692	-	■	-	18,8	0.740	14,4	0.567
SD100-18.80-P	00059691	■	-	-	18,0	0.709	14,4	0.567

Wstęp

Wiercenie

Rozwiercanie

Wytaczanie

Załącznik

Oznaczenie	Numer produktu	Geometria P	Geometria M	Geometria K	DC		OAL	
					mm	cal.	mm	cal.
SD100-18.90-M	02592746	-	■	-	18,9	0.744	14,4	0.567
SD100-18.90-P	00030901	■	-	-	18,9	0.744	14,4	0.567
SD100-19.00-K	00059696	-	-	■	19,0	0.748	15,2	0.598
SD100-19.00-M	00059695	-	■	-	19,0	0.748	15,2	0.598
SD100-19.00-P	00059694	■	-	-	19,0	0.748	15,2	0.598
SD100-19.05-K	00059699	-	-	■	19,05	0.750	15,2	0.598
SD100-19.05-M	00059698	-	■	-	19,05	0.750	15,2	0.598
SD100-19.05-P	00059697	■	-	-	19,05	0.750	15,2	0.598
SD100-19.10-P	00030902	■	-	-	19,1	0.752	15,2	0.598
SD100-19.20-K	00071566	-	-	■	19,2	0.756	15,2	0.598
SD100-19.20-M	00071564	-	■	-	19,2	0.756	15,2	0.598
SD100-19.20-P	00071563	■	-	-	19,2	0.756	15,2	0.598
SD100-19.25-P	00048318	■	-	-	19,25	0.758	15,2	0.598
SD100-19.45-K	00035202	-	-	■	19,45	0.766	15,2	0.598
SD100-19.45-M	00035201	-	■	-	19,45	0.766	15,2	0.598
SD100-19.45-P	00035200	■	-	-	19,45	0.766	15,2	0.598
SD100-19.50-K	00059702	-	-	■	19,5	0.768	15,2	0.598
SD100-19.50-M	00059701	-	■	-	19,5	0.768	15,2	0.598
SD100-19.50-P	00059700	■	-	-	19,5	0.768	15,2	0.598
SD100-19.70-K	00059705	-	-	■	19,7	0.776	15,2	0.598
SD100-19.70-M	00059704	-	■	-	19,7	0.776	15,2	0.598
SD100-19.70-P	00059703	■	-	-	19,7	0.776	15,2	0.598
SD100-19.80-K	00059708	-	-	■	19,8	0.780	15,2	0.598
SD100-19.80-M	00059707	-	■	-	19,8	0.780	15,2	0.598
SD100-19.80-P	00059706	■	-	-	19,8	0.780	15,2	0.598
SD100-19.84-M	00035204	-	■	-	19,84	0.781	15,2	0.598
SD100-19.84-P	00035203	■	-	-	19,84	0.781	15,2	0.598
SD100-19.90-M	02592747	-	■	-	19,9	0.783	15,2	0.598
SD100-19.90-P	00010065	■	-	-	19,9	0.783	15,2	0.598
SD100-19.99-P	00081744	■	-	-	19,99	0.787	15,2	0.598
SD100-20.00-K	02433368	-	-	■	20,0	0.787	15,2	0.598
SD100-20.00-M	02469176	-	■	-	20,0	0.787	15,2	0.598
SD100-20.00-P	02469095	■	-	-	20,0	0.787	15,2	0.598
SD100-20.241-P	02469096	■	-	-	20,241	0.797	15,2	0.598
SD100-20.50-K	02569177	-	-	■	20,5	0.807	15,2	0.598
SD100-20.50-M	02469178	-	■	-	20,5	0.807	15,2	0.598
SD100-20.50-P	02469098	■	-	-	20,5	0.807	15,2	0.598
SD100-20.638-M	02469179	-	■	-	20,638	0.813	15,2	0.598
SD100-20.638-P	02469100	■	-	-	20,638	0.813	15,2	0.598
SD100-20.80-P	02508750	■	-	-	20,8	0.819	15,2	0.598
SD100-20.90-P	02586615	■	-	-	20,9	0.823	15,2	0.598
SD100-21.00-K	02523183	-	-	■	21,0	0.827	15,2	0.598
SD100-21.00-M	02469180	-	■	-	21,0	0.827	15,2	0.598
SD100-21.00-P	02469118	■	-	-	21,0	0.827	15,2	0.598
SD100-21.034-P	02469120	■	-	-	21,034	0.828	15,2	0.598
SD100-21.20-P	02469121	■	-	-	21,2	0.835	15,2	0.598
SD100-21.30-P	02521624	■	-	-	21,3	0.839	15,2	0.598
SD100-21.430-M	02469182	-	■	-	21,43	0.844	15,2	0.598
SD100-21.430-P	02469122	■	-	-	21,43	0.844	15,2	0.598
SD100-21.50-K	02521338	-	-	■	21,5	0.846	15,2	0.598
SD100-21.50-M	02469183	-	■	-	21,5	0.846	15,2	0.598

Wstęp

Wiercenie

Rozwiercanie

Wylaczanie

Zalacznik

Oznaczenie	Numer produktu	Geometria P	Geometria M	Geometria K	DC		OAL	
					mm	cal.	mm	cal.
SD100-21.50-P	02469124	■	-	-	21,5	0.846	15,2	0.598
SD100-21.80-K	02592763	-	-	■	21,8	0.858	15,2	0.598
SD100-21.80-M	02555978	-	■	-	21,8	0.858	15,2	0.598
SD100-21.80-P	02592735	■	-	-	21,8	0.858	15,2	0.598
SD100-21.829-P	02469125	■	-	-	21,829	0.859	15,2	0.598
SD100-21.90-M	02592752	-	■	-	21,9	0.862	15,2	0.598
SD100-21.90-P	02592736	■	-	-	21,9	0.862	15,2	0.598
SD100-22.00-K	02511599	-	-	■	22,0	0.866	15,2	0.598
SD100-22.00-M	02469185	-	■	-	22,0	0.866	15,2	0.598
SD100-22.00-P	02469128	■	-	-	22,0	0.866	15,2	0.598
SD100-22.225-M	02469186	-	■	-	22,225	0.875	15,2	0.598
SD100-22.225-P	02469129	■	-	-	22,225	0.875	15,2	0.598
SD100-22.50-K	02569178	-	-	■	22,5	0.886	15,2	0.598
SD100-22.50-M	02469188	-	■	-	22,5	0.886	15,2	0.598
SD100-22.50-P	02469132	■	-	-	22,5	0.886	15,2	0.598
SD100-22.621-P	02469133	■	-	-	22,621	0.891	15,2	0.598
SD100-22.80-M	02592754	-	■	-	22,8	0.898	15,2	0.598
SD100-22.80-P	02539323	■	-	-	22,8	0.898	15,2	0.598
SD100-22.90-P	02592738	■	-	-	22,9	0.902	15,2	0.598
SD100-23.00-K	02515181	-	-	■	23,0	0.906	15,2	0.598
SD100-23.00-M	02469189	-	■	-	23,0	0.906	15,2	0.598
SD100-23.00-P	02469134	■	-	-	23,0	0.906	15,2	0.598
SD100-23.416-P	02469136	■	-	-	23,416	0.922	15,2	0.598
SD100-23.50-K	02551252	-	-	■	23,5	0.925	15,2	0.598
SD100-23.50-M	02469190	-	■	-	23,5	0.925	15,2	0.598
SD100-23.50-P	02469138	■	-	-	23,5	0.925	15,2	0.598
SD100-23.813-K	02592766	-	-	■	23,813	0.938	15,2	0.598
SD100-23.813-M	02554971	-	■	-	23,813	0.938	15,2	0.598
SD100-23.813-P	02469140	■	-	-	23,813	0.938	15,2	0.598
SD100-23.90-M	02592756	-	■	-	23,9	0.941	15,2	0.598
SD100-23.90-P	02592739	■	-	-	23,9	0.941	15,2	0.598
SD100-24.00-K	02569179	-	-	■	24,0	0.945	15,2	0.598
SD100-24.00-M	02469191	-	■	-	24,0	0.945	15,2	0.598
SD100-24.00-P	02469141	■	-	-	24,0	0.945	15,2	0.598
SD100-24.209-P	02469142	■	-	-	24,209	0.953	15,2	0.598
SD100-24.50-K	02569180	-	-	■	24,5	0.965	15,2	0.598
SD100-24.50-M	02469192	-	■	-	24,5	0.965	15,2	0.598
SD100-24.50-P	02469144	■	-	-	24,5	0.965	15,2	0.598
SD100-24.605-P	02469145	■	-	-	24,605	0.969	15,2	0.598
SD100-24.80-K	02592767	-	-	■	24,8	0.976	15,2	0.598
SD100-24.80-M	02508165	-	■	-	24,8	0.976	15,2	0.598
SD100-24.80-P	02529665	■	-	-	24,8	0.976	15,2	0.598
SD100-24.90-M	02592757	-	■	-	24,9	0.980	15,2	0.598
SD100-24.90-P	02592740	■	-	-	24,9	0.980	15,2	0.598
SD100-25.00-K	02524629	-	-	■	25,0	0.984	15,2	0.598
SD100-25.00-M	02469193	-	■	-	25,0	0.984	15,2	0.598
SD100-25.00-P	02469146	■	-	-	25,0	0.984	15,2	0.598
SD100-25.40-K	02569181	-	-	■	25,4	1.000	15,2	0.598
SD100-25.400-M	02469194	-	■	-	25,4	1.000	15,2	0.598
SD100-25.400-P	02469147	■	-	-	25,4	1.000	15,2	0.598
SD100-25.50-P	02536609	■	-	-	25,5	1.004	15,2	0.598

Wstęp

Wiercenie

Rozwiercanie

Wytaczanie

Załącznik

Oznaczenie	Numer produktu	Geometria P	Geometria M	Geometria K	DC		OAL	
					mm	cal.	mm	cal.
SD100-25.60-P	02519477	■	-	-	25,6	1.008	15,2	0.598
SD100-25.80-M	02592758	-	■	-	25,8	1.016	15,2	0.598
SD100-25.80-P	02581593	■	-	-	25,8	1.016	15,2	0.598
SD100-25.90-M	02592759	-	■	-	25,9	1.020	15,2	0.598
SD100-25.90-P	02592741	■	-	-	25,9	1.020	15,2	0.598
SD100-25.99-K	02516403	-	-	■	25,99	1.023	15,2	0.598
SD100-25.99-P	02516402	■	-	-	25,99	1.023	15,2	0.598

■ Standard magazynowy.

Moduł fazujący

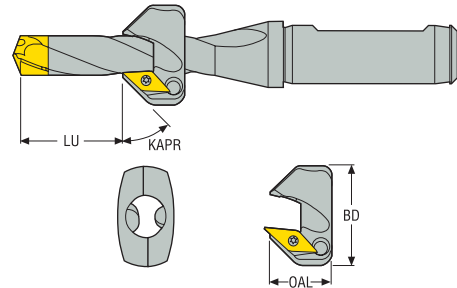

Głębokość wiercenia LU

Oznaczenie	Numer produktu	Do korpusu wiertła	SD101 (min-max)		SD103 (min-max)		SD105 (min-max)		SD107 (min-max)		Maks. głębokość fazy (mm)		OAL	BD
			mm	Cal.	mm	Cal.	mm	Cal.	mm	Cal.	mm	Cal.		
SD100-C45-12.00/12.49	00014922	SD10x-12.00/12.49	12,0 0.472	13,0 0.512	12,0 0.472	28,0 1.102	28,0 1.102	53,0 2.087	53,0 2.087	78,0 3.071	1,5 0.059	19,0 0.748	28,0 1.102	
SD100-C45-12.50/12.99	00014923	SD10x-12.50/12.99	12,0 0.472	14,0 0.551	12,0 0.472	29,0 1.142	29,0 1.142	54,0 2.126	54,0 2.126	79,0 3.110	1,5 0.059	19,0 0.748	28,0 1.102	
SD100-C45-13.00/13.99	00014924	SD10x-13.00/13.99	13,0 0.512	14,0 0.551	13,0 0.512	29,0 1.142	29,0 1.142	54,0 2.126	54,0 2.126	79,0 3.110	1,5 0.059	19,0 0.748	28,0 1.102	
SD100-C45-14.00/14.99	00014928	SD10x-14.00/14.99	14,0 0.551	20,0 0.787	14,0 0.551	40,0 1.575	40,0 1.575	70,0 2.756	70,0 2.756	100,0 3.937	2,0 0.079	19,0 0.748	31,0 1.220	
SD100-C45-15.00/15.99	00014931	SD10x-15.00/15.99	14,0 0.551	21,0 0.827	14,0 0.551	41,0 1.614	41,0 1.614	71,0 2.795	71,0 2.795	101,0 3.976	2,0 0.079	19,0 0.748	31,0 1.220	
SD100-C45-16.00/16.99	00014932	SD10x-16.00/16.99	15,0 0.591	22,0 0.866	15,0 0.591	42,0 1.654	42,0 1.654	72,0 2.835	72,0 2.835	102,0 4.016	2,0 0.079	19,0 0.748	31,0 1.220	
SD100-C45-17.00/17.99	00014933	SD10x-17.00/17.99	16,0 0.630	25,0 0.984	16,0 0.630	51,0 2.008	51,0 2.008	87,0 3.425	87,0 3.425	123,0 4.843	2,0 0.079	19,0 0.748	36,0 1.417	
SD100-C45-18.00/18.99	00014935	SD10x-18.00/18.99	17,0 0.669	26,0 1.024	17,0 0.669	52,0 2.047	52,0 2.047	88,0 3.465	88,0 3.465	124,0 4.882	2,0 0.079	19,0 0.748	36,0 1.417	
SD100-C45-19.00/19.99	00014936	SD10x-19.00/19.99	18,0 0.709	27,0 1.063	18,0 0.709	53,0 2.087	53,0 2.087	89,0 3.504	89,0 3.504	125,0 4.921	2,0 0.079	19,0 0.748	36,0 1.417	

Części zamienne, zawarte w dostawie

Dla śred. wiertła (mm)	Śruba mocująca płytkę		Klucz do płytek		Klucz mocujący	
	Płytki	Moduł	Płytki		Moduł	
SD100-12.00-16.99	C02205-T07P	C04011-T15P	T07P-2		T15P-2	
SD100-17.00-19.99	C02205-T07P	C05012-T15P	T07P-2		T15P-2	

Płytki

Tolerancje: mm/cal.	Wielkość		L	RE	IC	D1	S		
			mm/cal.	EPSR	mm/cal.	mm/cal.	AN	mm/cal.	
		09	9,0/ 2.187	35°	0,2/ 0.0078	5,556/ 2.187	2,9/ 1.141	7°	2,5/ 0.0984
	Gatunek: T400D								
	Oznaczenie: VCGX090202-D1								
	Numer produktu: 00014948								

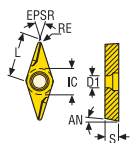

IC = ±0,025/ 0.009842
S = ±0,07/ 0.027559
RE = ±0,10/ 0.039370

Wstęp

Wiercenie

Rozwiercanie

Wyłaczanie

Załącznik

Moduł fazujący - Wskazówki dotyczące mocowania /montaż modułu

1. Założyć moduł na wiertło bez zamocowanej płytki fazującej i końcówki wiertła.

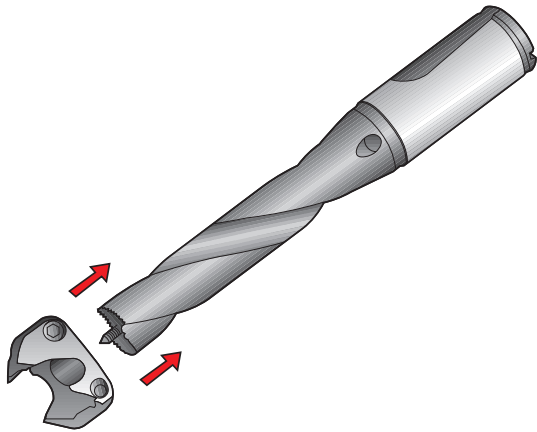

2.1 Jeśli to możliwe, umieścić moduł jak najbliżej chwytu.

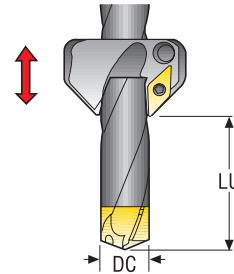

DC		LU głębokość wiercenia (min-maks)			
mm	cale	SD101		SD103	
mm	cale	mm	cale	mm	cale
12	.472	12-13	.472-.512	12-28	.472-1.102
12,5	.492	12-14	.472-.551	12-29	.472-1.142
13	.512	13-14	.512-.551	13-29	.512-1.142
14	.551	14-20	.551-.787	14-40	.551-1.575
15	.591	14-21	.551-.827	14-41	.551-1.614
16	.630	15-22	.591-.866	15-42	.591-1.654
17	.669	16-25	.630-.984	16-51	.630-2.008
18	.709	17-26	.669-1.024	17-52	.669-2.047
19	.748	18-27	.709-1.063	18-53	.709-2.087

2.2 Jeśli to możliwe, umieścić moduł jak najbliżej chwytu.

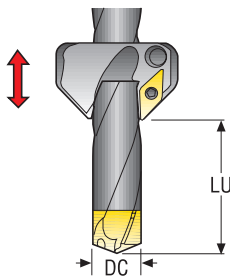

DC		LU głębokość wiercenia (min-maks)			
mm	cale	SD105		SD107	
mm	cale	mm	cale	mm	cale
12	.472	28-53	1.102-2.087	53-78	2.087-3.071
12,5	.492	29-54	1.142-2.126	54-79	2.126-3.110
13	.512	29-54	1.142-2.126	54-79	2.126-3.110
14	.551	40-70	1.575-2.756	70-100	2.756-3.937
15	.591	41-71	1.614-2.785	71-101	2.795-3.976
16	.630	42-72	1.654-2.835	72-102	2.835-4.016
17	.669	51-87	2.008-3.425	87-123	3.425-4.843
18	.709	52-88	2.047-3.465	88-124	3.465-4.882
19	.748	53-89	2.087-3.504	89-125	3.504-4.921

4. Dokręcić obie śrubki zgodnie z powyższą tabelką.

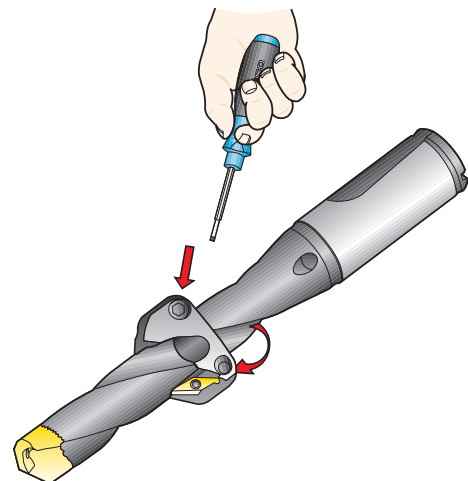

DC		M	
mm	cale	Nm	in-lbs
12-19	.472-.748	3-4	26-35

Moduł fazujący

Zalecana prędkość skrawania i posuw dla Crownloc® na str. 191-194 stosować także przy operacjach fazowania.

Rozwiązywanie problemów

Drgania podczas fazowania

- Zredukować prędkość skrawania
- Jeśli to możliwe, przesunąć moduł bliżej chwytu wiertła
- Jeśli to możliwe, stosować krótsze wiertło

Maksymalna głębokość fazy

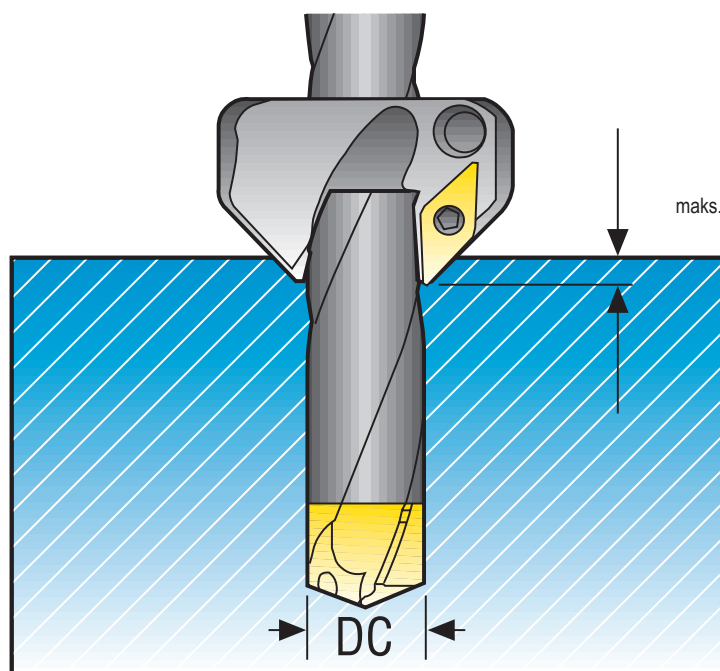

DC		Maks.	
mm	cale	mm	cale
12-13	.472-512	1,5	.059
14-19	.551-.748	2	.079

SMG		f									v _c
		Ø 10.00 Ø 0.394	Ø 12.00 Ø 0.472	Ø 14.00 Ø 0.551	Ø 16.00 Ø 0.630	Ø 18.00 Ø 0.709	Ø 20.00 Ø 0.787	Ø 22.00 Ø 0.866	Ø 24.00 Ø 0.945	Ø 26.00 Ø 1.024	
P1	P	0,20	0,24	0,26	0,28	0,30	0,32	0,34	0,34	0,36	125
	P	0.0080	0.0095	0.010	0.011	0.012	0.013	0.013	0.013	0.014	410
P2	P	0,20	0,24	0,26	0,28	0,30	0,32	0,34	0,36	0,36	120
	P	0.0080	0.0095	0.010	0.011	0.012	0.013	0.013	0.014	0.014	395
P3	P	0,19	0,22	0,25	0,26	0,28	0,30	0,32	0,34	0,34	105
	P	0.0075	0.0085	0.010	0.010	0.011	0.012	0.013	0.013	0.013	345
P4	P	0,19	0,22	0,24	0,26	0,28	0,30	0,32	0,32	0,34	95
	P	0.0075	0.0085	0.0095	0.010	0.011	0.012	0.013	0.013	0.013	310
P5	P	0,19	0,22	0,24	0,26	0,28	0,30	0,30	0,32	0,34	90
	P	0.0075	0.0085	0.0095	0.010	0.011	0.012	0.012	0.013	0.013	295
P6	P	0,18	0,22	0,24	0,26	0,28	0,28	0,30	0,32	0,32	100
	P	0.0070	0.0085	0.0095	0.010	0.011	0.011	0.012	0.013	0.013	330
P7	P	0,18	0,22	0,24	0,26	0,28	0,28	0,30	0,32	0,32	95
	P	0.0070	0.0085	0.0095	0.010	0.011	0.011	0.012	0.013	0.013	310
P8	P	0,19	0,22	0,25	0,26	0,28	0,30	0,32	0,34	0,34	90
	P	0.0075	0.0085	0.010	0.010	0.011	0.012	0.013	0.013	0.013	295
P11	P	0,18	0,22	0,24	0,26	0,28	0,28	0,30	0,32	0,32	90
	P	0.0070	0.0085	0.0095	0.010	0.011	0.011	0.012	0.013	0.013	295
P12	P	0,13	0,15	0,16	0,18	0,19	0,20	0,20	0,22	0,22	55
	P	0.0050	0.0060	0.0065	0.0070	0.0075	0.0080	0.0080	0.0085	0.0085	180
M1	M	0,14	0,15	0,15	0,16	0,16	0,16	0,17	0,17	0,17	85
	M	0.0055	0.0060	0.0060	0.0065	0.0065	0.0065	0.0065	0.0065	0.0065	280
M2	M	0,13	0,13	0,14	0,14	0,15	0,15	0,15	0,16	0,16	70
	M	0.0050	0.0050	0.0055	0.0055	0.0060	0.0060	0.0060	0.0065	0.0065	230
M3	M	0,10	0,11	0,11	0,11	0,12	0,12	0,12	0,12	0,13	50
	M	0.0040	0.0044	0.0044	0.0044	0.0048	0.0048	0.0048	0.0048	0.0050	165
M4	M	0,090	0,095	0,095	0,10	0,10	0,10	0,11	0,11	0,11	39
	M	0.0036	0.0038	0.0038	0.0040	0.0040	0.0040	0.0044	0.0044	0.0044	130
M5	M	0,090	0,095	0,095	0,10	0,10	0,10	0,11	0,11	0,11	33
	M	0.0036	0.0038	0.0038	0.0040	0.0040	0.0040	0.0044	0.0044	0.0044	110
K1	K	0,28	0,32	0,34	0,36	0,38	0,40	0,42	0,42	0,44	100
	K	0.011	0.013	0.013	0.014	0.015	0.016	0.017	0.017	0.017	330
K2	K	0,26	0,28	0,30	0,32	0,34	0,36	0,38	0,38	0,40	85
	K	0.010	0.011	0.012	0.013	0.013	0.014	0.015	0.015	0.016	280
K3	K	0,26	0,28	0,30	0,32	0,34	0,36	0,38	0,38	0,40	70
	K	0.010	0.011	0.012	0.013	0.013	0.014	0.015	0.015	0.016	230
K4	K	0,26	0,28	0,30	0,32	0,34	0,36	0,38	0,38	0,40	70
	K	0.010	0.011	0.012	0.013	0.013	0.014	0.015	0.015	0.016	230
K5	K	0,24	0,26	0,28	0,30	0,32	0,32	0,34	0,36	0,36	41
	K	0.0095	0.010	0.011	0.012	0.013	0.013	0.013	0.014	0.014	135
N1	M	0,18	0,19	0,19	0,20	0,20	0,20	0,22	0,22	0,22	335
	M	0.0070	0.0075	0.0075	0.0080	0.0080	0.0080	0.0085	0.0085	0.0085	1100
N2	M	0,18	0,19	0,19	0,20	0,20	0,20	0,22	0,22	0,22	215
	M	0.0070	0.0075	0.0075	0.0080	0.0080	0.0080	0.0085	0.0085	0.0085	710
N3	M	0,18	0,19	0,19	0,20	0,20	0,20	0,22	0,22	0,22	145
	M	0.0070	0.0075	0.0075	0.0080	0.0080	0.0080	0.0085	0.0085	0.0085	475
N11	M	0,18	0,19	0,19	0,20	0,20	0,20	0,22	0,22	0,22	170
	M	0.0070	0.0075	0.0075	0.0080	0.0080	0.0080	0.0085	0.0085	0.0085	560
S1	M	0,090	0,095	0,095	0,10	0,10	0,10	0,11	0,11	0,11	34
	M	0.0036	0.0038	0.0038	0.0040	0.0040	0.0040	0.0044	0.0044	0.0044	110
S2	M	0,090	0,095	0,095	0,10	0,10	0,10	0,11	0,11	0,11	25
	M	0.0036	0.0038	0.0038	0.0040	0.0040	0.0040	0.0044	0.0044	0.0044	80
S3	M	0,085	0,085	0,090	0,095	0,095	0,095	0,10	0,10	0,10	25
	M	0.0034	0.0034	0.0036	0.0038	0.0038	0.0038	0.0040	0.0040	0.0040	80
S11	M	0,10	0,11	0,11	0,11	0,12	0,12	0,12	0,12	0,13	65
	M	0.0040	0.0044	0.0044	0.0044	0.0048	0.0048	0.0048	0.0048	0.0050	215
S12	M	0,10	0,11	0,11	0,11	0,12	0,12	0,12	0,12	0,13	49
	M	0.0040	0.0044	0.0044	0.0044	0.0048	0.0048	0.0048	0.0048	0.0050	160
S13	M	0,090	0,095	0,095	0,10	0,10	0,10	0,11	0,11	0,11	38
	M	0.0036	0.0038	0.0038	0.0040	0.0040	0.0040	0.0044	0.0044	0.0044	125
H3	P	0,085	0,095	0,11	0,12	0,12	0,13	0,14	0,14	0,15	27
	P	0.0034	0.0038	0.0044	0.0048	0.0048	0.0050	0.0055	0.0055	0.0060	90
H5	P	0,13	0,15	0,16	0,18	0,19	0,20	0,20	0,22	0,22	50
	P	0.0050	0.0060	0.0065	0.0070	0.0075	0.0080	0.0080	0.0085	0.0085	165
H7	P	0,085	0,095	0,11	0,12	0,12	0,13	0,14	0,14	0,15	27
	P	0.0034	0.0038	0.0044	0.0048	0.0048	0.0050	0.0055	0.0055	0.0060	90
H8	P	0,095	0,11	0,12	0,13	0,14	0,15	0,16	0,17	0,17	50
	P	0.0038	0.0044	0.0048	0.0050	0.0055	0.0060	0.0065	0.0065	0.0065	165
H11	P	0,13	0,15	0,16	0,18	0,19	0,20	0,20	0,22	0,22	65
	P	0.0050	0.0060	0.0065	0.0070	0.0075	0.0080	0.0080	0.0085	0.0085	215
H12	P	0,095	0,11	0,12	0,13	0,14	0,15	0,16	0,17	0,17	32
	P	0.0038	0.0044	0.0048	0.0050	0.0055	0.0060	0.0065	0.0065	0.0065	105
H21	P	0,095	0,11	0,12	0,13	0,14	0,15	0,16	0,17	0,17	50
	P	0.0038	0.0044	0.0048	0.0050	0.0055	0.0060	0.0065	0.0065	0.0065	165

SMG = Grupy materiałowe Seco f = mm/obr (cal/obr) v_c = m/min (stp/min) Wszystkie parametry są wartościami początkowymi

Wstęp

Wiercenie

Rozwiercanie

Wylaczanie

Zalacznik

SD103 – Ø 10-26 mm / 0.394-1.024 cal

SMG		f									v _c
		Ø 10.00 Ø 0.394	Ø 12.00 Ø 0.472	Ø 14.00 Ø 0.551	Ø 16.00 Ø 0.630	Ø 18.00 Ø 0.709	Ø 20.00 Ø 0.787	Ø 22.00 Ø 0.866	Ø 24.00 Ø 0.945	Ø 26.00 Ø 1.024	
P1	P	0,20	0,24	0,26	0,28	0,30	0,32	0,34	0,34	0,36	120
	P	0.008	0.0095	0.01	0.011	0.012	0.013	0.013	0.013	0.014	395
P2	P	0,20	0,24	0,26	0,28	0,30	0,32	0,34	0,36	0,36	115
	P	0.008	0.0095	0.01	0.011	0.012	0.013	0.013	0.014	0.014	375
P3	P	0,19	0,22	0,25	0,26	0,28	0,30	0,32	0,34	0,34	100
	P	0.0075	0.0085	0.01	0.01	0.011	0.012	0.013	0.013	0.013	330
P4	P	0,19	0,22	0,24	0,26	0,28	0,30	0,32	0,32	0,34	85
	P	0.0075	0.0085	0.0095	0.01	0.011	0.012	0.013	0.013	0.013	280
P5	P	0,19	0,22	0,24	0,26	0,28	0,30	0,30	0,32	0,34	85
	P	0.0075	0.0085	0.0095	0.01	0.011	0.012	0.012	0.013	0.013	280
P6	P	0,18	0,22	0,24	0,26	0,28	0,28	0,30	0,32	0,32	95
	P	0.007	0.0085	0.0095	0.01	0.011	0.011	0.012	0.013	0.013	310
P7	P	0,18	0,22	0,24	0,26	0,28	0,28	0,30	0,32	0,32	90
	P	0.007	0.0085	0.0095	0.01	0.011	0.011	0.012	0.013	0.013	295
P8	P	0,19	0,22	0,25	0,26	0,28	0,30	0,32	0,34	0,34	85
	P	0.0075	0.0085	0.01	0.01	0.011	0.012	0.013	0.013	0.013	280
P11	P	0,18	0,22	0,24	0,26	0,28	0,28	0,30	0,32	0,32	85
	P	0.007	0.0085	0.0095	0.01	0.011	0.011	0.012	0.013	0.013	280
P12	P	0,13	0,15	0,16	0,18	0,19	0,20	0,20	0,22	0,22	50
	P	0.005	0.006	0.0065	0.007	0.0075	0.008	0.008	0.0085	0.0085	165
M1	M	0,14	0,15	0,15	0,16	0,16	0,16	0,17	0,17	0,17	80
	M	0.0055	0.006	0.006	0.0065	0.0065	0.0065	0.0065	0.0065	0.0065	260
M2	M	0,13	0,13	0,14	0,14	0,15	0,15	0,15	0,16	0,16	65
	M	0.005	0.005	0.0055	0.0055	0.006	0.006	0.006	0.0065	0.0065	215
M3	M	0,10	0,11	0,11	0,11	0,12	0,12	0,12	0,12	0,13	49
	M	0.004	0.0044	0.0044	0.0044	0.0048	0.0048	0.0048	0.0048	0.005	160
M4	M	0,090	0,095	0,095	0,10	0,10	0,10	0,11	0,11	0,11	37
	M	0.0036	0.0038	0.0038	0.004	0.004	0.004	0.0044	0.0044	0.0044	120
M5	M	0,090	0,095	0,095	0,10	0,10	0,10	0,11	0,11	0,11	31
	M	0.0036	0.0038	0.0038	0.004	0.004	0.004	0.0044	0.0044	0.0044	100
K1	K	0,28	0,32	0,34	0,36	0,38	0,40	0,42	0,42	0,44	90
	K	0.011	0.013	0.013	0.014	0.015	0.016	0.017	0.017	0.017	295
K2	K	0,26	0,28	0,30	0,32	0,34	0,36	0,38	0,38	0,40	80
	K	0.01	0.011	0.012	0.013	0.013	0.014	0.015	0.015	0.016	260
K3	K	0,26	0,28	0,30	0,32	0,34	0,36	0,38	0,38	0,40	65
	K	0.01	0.011	0.012	0.013	0.013	0.014	0.015	0.015	0.016	215
K4	K	0,26	0,28	0,30	0,32	0,34	0,36	0,38	0,38	0,40	65
	K	0.01	0.011	0.012	0.013	0.013	0.014	0.015	0.015	0.016	215
K5	K	0,24	0,26	0,28	0,30	0,32	0,32	0,34	0,36	0,36	38
	K	0.0095	0.01	0.011	0.012	0.013	0.013	0.013	0.014	0.014	125
N1	M	0,18	0,19	0,19	0,20	0,20	0,20	0,22	0,22	0,22	315
	M	0.007	0.0075	0.0075	0.008	0.008	0.008	0.0085	0.0085	0.0085	1025
N2	M	0,18	0,19	0,19	0,20	0,20	0,20	0,22	0,22	0,22	200
	M	0.007	0.0075	0.0075	0.008	0.008	0.008	0.0085	0.0085	0.0085	660
N3	M	0,18	0,19	0,19	0,20	0,20	0,20	0,22	0,22	0,22	135
	M	0.007	0.0075	0.0075	0.008	0.008	0.008	0.0085	0.0085	0.0085	445
N11	M	0,18	0,19	0,19	0,20	0,20	0,20	0,22	0,22	0,22	160
	M	0.007	0.0075	0.0075	0.008	0.008	0.008	0.0085	0.0085	0.0085	520
S1	M	0,090	0,095	0,095	0,10	0,10	0,10	0,11	0,11	0,11	32
	M	0.0036	0.0038	0.0038	0.004	0.004	0.004	0.0044	0.0044	0.0044	105
S2	M	0,090	0,095	0,095	0,10	0,10	0,10	0,11	0,11	0,11	23
	M	0.0036	0.0038	0.0038	0.004	0.004	0.004	0.0044	0.0044	0.0044	75
S3	M	0,085	0,085	0,090	0,095	0,095	0,095	0,10	0,10	0,10	23
	M	0.0034	0.0034	0.0036	0.0038	0.0038	0.0038	0.004	0.004	0.004	75
S11	M	0,10	0,11	0,11	0,11	0,12	0,12	0,12	0,12	0,13	60
	M	0.004	0.0044	0.0044	0.0044	0.0048	0.0048	0.0048	0.0048	0.005	195
S12	M	0,10	0,11	0,11	0,11	0,12	0,12	0,12	0,12	0,13	46
	M	0.004	0.0044	0.0044	0.0044	0.0048	0.0048	0.0048	0.0048	0.005	150
S13	M	0,090	0,095	0,095	0,10	0,10	0,10	0,11	0,11	0,11	36
	M	0.0036	0.0038	0.0038	0.004	0.004	0.004	0.0044	0.0044	0.0044	120
H3	P	0,085	0,095	0,11	0,12	0,12	0,13	0,14	0,14	0,15	25
	P	0.0034	0.0038	0.0044	0.0048	0.0048	0.005	0.0055	0.0055	0.006	80
H5	P	0,13	0,15	0,16	0,18	0,19	0,20	0,20	0,22	0,22	46
	P	0.005	0.006	0.0065	0.007	0.0075	0.008	0.008	0.0085	0.0085	150
H7	P	0,085	0,095	0,11	0,12	0,12	0,13	0,14	0,14	0,15	25
	P	0.0034	0.0038	0.0044	0.0048	0.0048	0.005	0.0055	0.0055	0.006	80
H8	P	0,095	0,11	0,12	0,13	0,14	0,15	0,16	0,17	0,17	46
	P	0.0038	0.0044	0.0048	0.005	0.0055	0.006	0.0065	0.0065	0.0065	150
H11	P	0,13	0,15	0,16	0,18	0,19	0,20	0,20	0,22	0,22	60
	P	0.005	0.006	0.0065	0.007	0.0075	0.008	0.008	0.0085	0.0085	195
H12	P	0,095	0,11	0,12	0,13	0,14	0,15	0,16	0,17	0,17	30
	P	0.0038	0.0044	0.0048	0.005	0.0055	0.006	0.0065	0.0065	0.0065	100
H21	P	0,095	0,11	0,12	0,13	0,14	0,15	0,16	0,17	0,17	46
	P	0.0038	0.0044	0.0048	0.005	0.0055	0.006	0.0065	0.0065	0.0065	150

SMG = Grupy materiałowe Seco f = mm/obr (cal/obr) v_c = m/min (stp/min) Wszystkie parametry są wartościami początkowymi

SMG		f									v _c
		Ø 10.00 Ø 0.394	Ø 12.00 Ø 0.472	Ø 14.00 Ø 0.551	Ø 16.00 Ø 0.630	Ø 18.00 Ø 0.709	Ø 20.00 Ø 0.787	Ø 22.00 Ø 0.866	Ø 24.00 Ø 0.945	Ø 26.00 Ø 1.024	
P1	P	0,20	0,24	0,26	0,28	0,30	0,32	0,34	0,34	0,36	110
	P	0,0080	0,0095	0,010	0,011	0,012	0,013	0,013	0,013	0,014	360
P2	P	0,20	0,24	0,26	0,28	0,30	0,32	0,34	0,36	0,36	110
	P	0,0080	0,0095	0,010	0,011	0,012	0,013	0,013	0,014	0,014	360
P3	P	0,19	0,22	0,25	0,26	0,28	0,30	0,32	0,34	0,34	95
	P	0,0075	0,0085	0,010	0,010	0,011	0,012	0,013	0,013	0,013	310
P4	P	0,19	0,22	0,24	0,26	0,28	0,30	0,32	0,32	0,34	85
	P	0,0075	0,0085	0,0095	0,010	0,011	0,012	0,013	0,013	0,013	280
P5	P	0,19	0,22	0,24	0,26	0,28	0,30	0,30	0,32	0,34	80
	P	0,0075	0,0085	0,0095	0,010	0,011	0,012	0,012	0,013	0,013	260
P6	P	0,18	0,22	0,24	0,26	0,28	0,28	0,30	0,32	0,32	90
	P	0,0070	0,0085	0,0095	0,010	0,011	0,011	0,012	0,013	0,013	295
P7	P	0,18	0,22	0,24	0,26	0,28	0,28	0,30	0,32	0,32	85
	P	0,0070	0,0085	0,0095	0,010	0,011	0,011	0,012	0,013	0,013	280
P8	P	0,19	0,22	0,25	0,26	0,28	0,30	0,32	0,34	0,34	80
	P	0,0075	0,0085	0,010	0,010	0,011	0,012	0,013	0,013	0,013	260
P11	P	0,18	0,22	0,24	0,26	0,28	0,28	0,30	0,32	0,32	80
	P	0,0070	0,0085	0,0095	0,010	0,011	0,011	0,012	0,013	0,013	260
P12	P	0,13	0,15	0,16	0,18	0,19	0,20	0,20	0,22	0,22	48
	P	0,0050	0,0060	0,0065	0,0070	0,0075	0,0080	0,0080	0,0085	0,0085	155
M1	M	0,14	0,15	0,15	0,16	0,16	0,16	0,17	0,17	0,17	75
	M	0,0055	0,0060	0,0060	0,0065	0,0065	0,0065	0,0065	0,0065	0,0065	245
M2	M	0,13	0,13	0,14	0,14	0,15	0,15	0,15	0,16	0,16	60
	M	0,0050	0,0050	0,0055	0,0055	0,0060	0,0060	0,0060	0,0065	0,0065	195
M3	M	0,10	0,11	0,11	0,11	0,12	0,12	0,12	0,12	0,13	46
	M	0,0040	0,0044	0,0044	0,0044	0,0048	0,0048	0,0048	0,0048	0,0050	150
M4	M	0,090	0,095	0,095	0,10	0,10	0,10	0,11	0,11	0,11	35
	M	0,0036	0,0038	0,0038	0,0040	0,0040	0,0040	0,0044	0,0044	0,0044	115
M5	M	0,090	0,095	0,095	0,10	0,10	0,10	0,11	0,11	0,11	29
	M	0,0036	0,0038	0,0038	0,0040	0,0040	0,0040	0,0044	0,0044	0,0044	95
K1	K	0,28	0,32	0,34	0,36	0,38	0,40	0,42	0,42	0,44	90
	K	0,011	0,013	0,013	0,014	0,015	0,016	0,017	0,017	0,017	295
K2	K	0,26	0,28	0,30	0,32	0,34	0,36	0,38	0,38	0,40	75
	K	0,010	0,011	0,012	0,013	0,013	0,014	0,015	0,015	0,016	245
K3	K	0,26	0,28	0,30	0,32	0,34	0,36	0,38	0,38	0,40	65
	K	0,010	0,011	0,012	0,013	0,013	0,014	0,015	0,015	0,016	215
K4	K	0,26	0,28	0,30	0,32	0,34	0,36	0,38	0,38	0,40	60
	K	0,010	0,011	0,012	0,013	0,013	0,014	0,015	0,015	0,016	195
K5	K	0,24	0,26	0,28	0,30	0,32	0,32	0,34	0,36	0,36	36
	K	0,0095	0,010	0,011	0,012	0,013	0,013	0,013	0,014	0,014	120
N1	M	0,18	0,19	0,19	0,20	0,20	0,20	0,22	0,22	0,22	300
	M	0,0070	0,0075	0,0075	0,0080	0,0080	0,0080	0,0085	0,0085	0,0085	980
N2	M	0,18	0,19	0,19	0,20	0,20	0,20	0,22	0,22	0,22	190
	M	0,0070	0,0075	0,0075	0,0080	0,0080	0,0080	0,0085	0,0085	0,0085	620
N3	M	0,18	0,19	0,19	0,20	0,20	0,20	0,22	0,22	0,22	130
	M	0,0070	0,0075	0,0075	0,0080	0,0080	0,0080	0,0085	0,0085	0,0085	425
N11	M	0,18	0,19	0,19	0,20	0,20	0,20	0,22	0,22	0,22	150
	M	0,0070	0,0075	0,0075	0,0080	0,0080	0,0080	0,0085	0,0085	0,0085	490
S1	M	0,090	0,095	0,095	0,10	0,10	0,10	0,11	0,11	0,11	30
	M	0,0036	0,0038	0,0038	0,0040	0,0040	0,0040	0,0044	0,0044	0,0044	100
S2	M	0,090	0,095	0,095	0,10	0,10	0,10	0,11	0,11	0,11	22
	M	0,0036	0,0038	0,0038	0,0040	0,0040	0,0040	0,0044	0,0044	0,0044	70
S3	M	0,085	0,085	0,090	0,095	0,095	0,095	0,10	0,10	0,10	22
	M	0,0034	0,0034	0,0036	0,0038	0,0038	0,0038	0,0040	0,0040	0,0040	70
S11	M	0,10	0,11	0,11	0,11	0,12	0,12	0,12	0,12	0,13	55
	M	0,0040	0,0044	0,0044	0,0044	0,0048	0,0048	0,0048	0,0048	0,0050	180
S12	M	0,10	0,11	0,11	0,11	0,12	0,12	0,12	0,12	0,13	44
	M	0,0040	0,0044	0,0044	0,0044	0,0048	0,0048	0,0048	0,0048	0,0050	145
S13	M	0,090	0,095	0,095	0,10	0,10	0,10	0,11	0,11	0,11	34
	M	0,0036	0,0038	0,0038	0,0040	0,0040	0,0040	0,0044	0,0044	0,0044	110
H3	P	0,085	0,095	0,11	0,12	0,12	0,13	0,14	0,14	0,15	24
	P	0,0034	0,0038	0,0044	0,0048	0,0048	0,0050	0,0055	0,0055	0,0060	80
H5	P	0,13	0,15	0,16	0,18	0,19	0,20	0,20	0,22	0,22	44
	P	0,0050	0,0060	0,0065	0,0070	0,0075	0,0080	0,0080	0,0085	0,0085	145
H7	P	0,085	0,095	0,11	0,12	0,12	0,13	0,14	0,14	0,15	24
	P	0,0034	0,0038	0,0044	0,0048	0,0048	0,0050	0,0055	0,0055	0,0060	80
H8	P	0,095	0,11	0,12	0,13	0,14	0,15	0,16	0,17	0,17	44
	P	0,0038	0,0044	0,0048	0,0050	0,0055	0,0060	0,0065	0,0065	0,0065	145
H11	P	0,13	0,15	0,16	0,18	0,19	0,20	0,20	0,22	0,22	55
	P	0,0050	0,0060	0,0065	0,0070	0,0075	0,0080	0,0080	0,0085	0,0085	180
H12	P	0,095	0,11	0,12	0,13	0,14	0,15	0,16	0,17	0,17	29
	P	0,0038	0,0044	0,0048	0,0050	0,0055	0,0060	0,0065	0,0065	0,0065	95
H21	P	0,095	0,11	0,12	0,13	0,14	0,15	0,16	0,17	0,17	44
	P	0,0038	0,0044	0,0048	0,0050	0,0055	0,0060	0,0065	0,0065	0,0065	145

SMG = Grupy materiałowe Seco f = mm/obr (cal/obr) v_c = m/min (stp/min) Wszystkie parametry są wartościami początkowymi

Wstęp

Wiercenie

Rozwiercanie

Wylaczanie

Zalacznik

SD107 – Ø 10-26 mm / 0.394-1.024 cal

SMG		f								V _c
		Ø 12.00 Ø 0.472	Ø 14.00 Ø 0.551	Ø 16.00 Ø 0.630	Ø 18.00 Ø 0.709	Ø 20.00 Ø 0.787	Ø 22.00 Ø 0.866	Ø 24.00 Ø 0.945	Ø 26.00 Ø 1.024	
P1	P	0,24	0,26	0,28	0,30	0,32	0,34	0,34	0,36	110
	P	0.0095	0.010	0.011	0.012	0.013	0.013	0.013	0.014	360
P2	P	0,24	0,26	0,28	0,30	0,32	0,34	0,36	0,36	105
	P	0.0095	0.010	0.011	0.012	0.013	0.013	0.014	0.014	345
P3	P	0,22	0,25	0,26	0,28	0,30	0,32	0,34	0,34	90
	P	0.0085	0.010	0.010	0.011	0.012	0.013	0.013	0.013	295
P4	P	0,22	0,24	0,26	0,28	0,30	0,32	0,32	0,34	80
	P	0.0085	0.0095	0.010	0.011	0.012	0.013	0.013	0.013	260
P5	P	0,22	0,24	0,26	0,28	0,30	0,30	0,32	0,34	75
	P	0.0085	0.0095	0.010	0.011	0.012	0.012	0.013	0.013	245
P6	P	0,22	0,24	0,26	0,28	0,28	0,30	0,32	0,32	85
	P	0.0085	0.0095	0.010	0.011	0.011	0.012	0.013	0.013	280
P7	P	0,22	0,24	0,26	0,28	0,28	0,30	0,32	0,32	80
	P	0.0085	0.0095	0.010	0.011	0.011	0.012	0.013	0.013	260
P8	P	0,22	0,25	0,26	0,28	0,30	0,32	0,34	0,34	75
	P	0.0085	0.010	0.010	0.011	0.012	0.013	0.013	0.013	245
P11	P	0,22	0,24	0,26	0,28	0,28	0,30	0,32	0,32	80
	P	0.0085	0.0095	0.010	0.011	0.011	0.012	0.013	0.013	260
P12	P	0,15	0,16	0,18	0,19	0,20	0,20	0,22	0,22	47
	P	0.0060	0.0065	0.0070	0.0075	0.0080	0.0080	0.0085	0.0085	155
M1	M	0,15	0,15	0,16	0,16	0,16	0,17	0,17	0,17	75
	M	0.0060	0.0060	0.0065	0.0065	0.0065	0.0065	0.0065	0.0065	245
M2	M	0,13	0,14	0,14	0,15	0,15	0,15	0,16	0,16	60
	M	0.0050	0.0055	0.0055	0.0060	0.0060	0.0060	0.0065	0.0065	195
M3	M	0,11	0,11	0,11	0,12	0,12	0,12	0,12	0,13	45
	M	0.0044	0.0044	0.0044	0.0048	0.0048	0.0048	0.0048	0.0050	150
M4	M	0,095	0,095	0,10	0,10	0,10	0,11	0,11	0,11	34
	M	0.0038	0.0038	0.0040	0.0040	0.0040	0.0044	0.0044	0.0044	110
M5	M	0,095	0,095	0,10	0,10	0,10	0,11	0,11	0,11	28
	M	0.0038	0.0038	0.0040	0.0040	0.0040	0.0044	0.0044	0.0044	90
K1	K	0,32	0,34	0,36	0,38	0,40	0,42	0,42	0,44	85
	K	0.013	0.013	0.014	0.015	0.016	0.017	0.017	0.017	280
K2	K	0,28	0,30	0,32	0,34	0,36	0,38	0,38	0,40	75
	K	0.011	0.012	0.013	0.013	0.014	0.015	0.015	0.016	245
K3	K	0,28	0,30	0,32	0,34	0,36	0,38	0,38	0,40	60
	K	0.011	0.012	0.013	0.013	0.014	0.015	0.015	0.016	195
K4	K	0,28	0,30	0,32	0,34	0,36	0,38	0,38	0,40	60
	K	0.011	0.012	0.013	0.013	0.014	0.015	0.015	0.016	195
K5	K	0,26	0,28	0,30	0,32	0,32	0,34	0,36	0,36	35
	K	0.010	0.011	0.012	0.013	0.013	0.013	0.014	0.014	115
N1	M	0,19	0,19	0,20	0,20	0,20	0,22	0,22	0,22	290
	M	0.0075	0.0075	0.0080	0.0080	0.0080	0.0085	0.0085	0.0085	950
N2	M	0,19	0,19	0,20	0,20	0,20	0,22	0,22	0,22	185
	M	0.0075	0.0075	0.0080	0.0080	0.0080	0.0085	0.0085	0.0085	610
N3	M	0,19	0,19	0,20	0,20	0,20	0,22	0,22	0,22	125
	M	0.0075	0.0075	0.0080	0.0080	0.0080	0.0085	0.0085	0.0085	410
N11	M	0,19	0,19	0,20	0,20	0,20	0,22	0,22	0,22	145
	M	0.0075	0.0075	0.0080	0.0080	0.0080	0.0085	0.0085	0.0085	475
S1	M	0,095	0,095	0,10	0,10	0,10	0,11	0,11	0,11	29
	M	0.0038	0.0038	0.0040	0.0040	0.0040	0.0044	0.0044	0.0044	95
S2	M	0,095	0,095	0,10	0,10	0,10	0,11	0,11	0,11	21
	M	0.0038	0.0038	0.0040	0.0040	0.0040	0.0044	0.0044	0.0044	70
S3	M	0,085	0,090	0,095	0,095	0,095	0,10	0,10	0,10	21
	M	0.0034	0.0036	0.0038	0.0038	0.0038	0.0040	0.0040	0.0040	70
S11	M	0,11	0,11	0,11	0,12	0,12	0,12	0,12	0,13	55
	M	0.0044	0.0044	0.0044	0.0048	0.0048	0.0048	0.0048	0.0050	180
S12	M	0,11	0,11	0,11	0,12	0,12	0,12	0,12	0,13	42
	M	0.0044	0.0044	0.0044	0.0048	0.0048	0.0048	0.0048	0.0050	140
S13	M	0,095	0,095	0,10	0,10	0,10	0,11	0,11	0,11	33
	M	0.0038	0.0038	0.0040	0.0040	0.0040	0.0044	0.0044	0.0044	110
H3	P	0,095	0,11	0,12	0,12	0,13	0,14	0,14	0,15	23
	P	0.0038	0.0044	0.0048	0.0048	0.0050	0.0055	0.0055	0.0060	75
H5	P	0,15	0,16	0,18	0,19	0,20	0,20	0,22	0,22	43
	P	0.0060	0.0065	0.0070	0.0075	0.0080	0.0080	0.0085	0.0085	140
H7	P	0,095	0,11	0,12	0,12	0,13	0,14	0,14	0,15	23
	P	0.0038	0.0044	0.0048	0.0048	0.0050	0.0055	0.0055	0.0060	75
H8	P	0,11	0,12	0,13	0,14	0,15	0,16	0,17	0,17	43
	P	0.0044	0.0048	0.0050	0.0055	0.0060	0.0065	0.0065	0.0065	140
H11	P	0,15	0,16	0,18	0,19	0,20	0,20	0,22	0,22	55
	P	0.0060	0.0065	0.0070	0.0075	0.0080	0.0080	0.0085	0.0085	180
H12	P	0,11	0,12	0,13	0,14	0,15	0,16	0,17	0,17	28
	P	0.0044	0.0048	0.0050	0.0055	0.0060	0.0065	0.0065	0.0065	90
H21	P	0,11	0,12	0,13	0,14	0,15	0,16	0,17	0,17	43
	P	0.0044	0.0048	0.0050	0.0055	0.0060	0.0065	0.0065	0.0065	140

SMG = Grupy materiałowe Seco f = mm/obr (cal/obr) v_c = m/min (stp/min) Wszystkie parametry są wartościami początkowymi

Wstęp

Wiercenie

Rozwiercanie

Wyłaczanie

Załącznik

Parametry skrawania

Wartości z wykresów mogą ulegać zmianie, zależnie od parametrów, materiału, wydajności obrabiarki i zużycia narzędzia.
Poniższe wykresy obowiązują dla grupy materiału P5-P6 i prędkości skrawania 90 m/min (295 sf/min).

Wstęp

Wiercenie

Rozwiercanie

Wyłaczanie

Załącznik

Zapotrzebowanie na moc

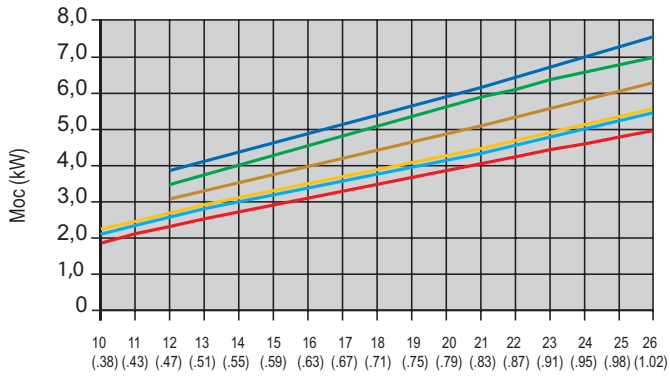

Średnica wiertła mm / (cale)

- f = 0,32 (0.013")
- f = 0,30 (0.012")
- f = 0,27 (0.011")
- f = 0,24 (0.009")
- f = 0,22 (0.0086")
- f = 0,20 (0.0078")

Moment obrotowy

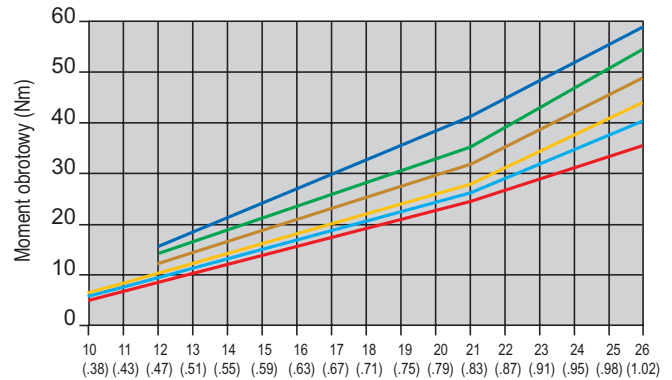

Średnica wiertła mm / (cale)

- f = 0,32 (0.013")
- f = 0,30 (0.012")
- f = 0,27 (0.011")
- f = 0,24 (0.009")
- f = 0,22 (0.0086")
- f = 0,20 (0.0078")

Siła od posuwu

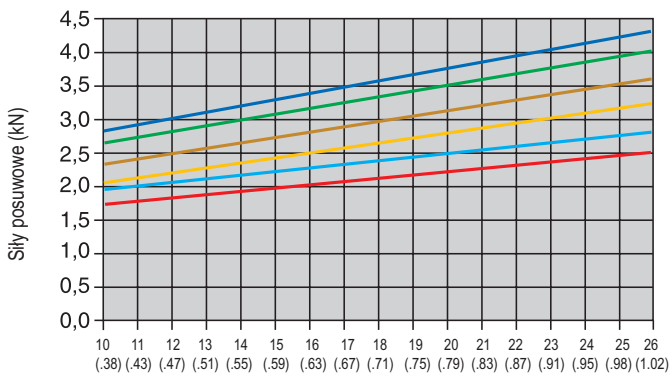

Średnica wiertła mm / (cale)

- f = 0,32 (0.013")
- f = 0,30 (0.012")
- f = 0,27 (0.011")
- f = 0,24 (0.009")
- f = 0,22 (0.0086")
- f = 0,20 (0.0078")

Przepływ chłodziwa przy różnych ciśnieniach

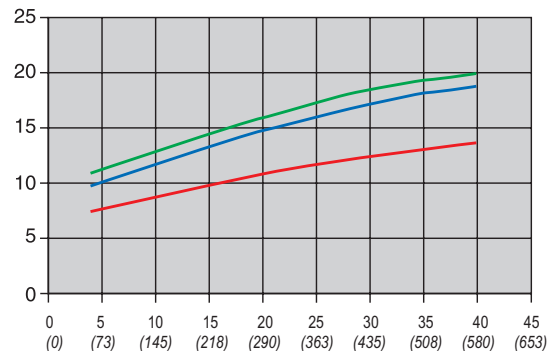

- Ø 17–19,99 mm (0.67–0.79")
- Ø 14–16,99 mm (0.55–0.67")
- Ø 12–13,99 mm (0.47–0.55")

Zalecany przepływ chłodziwa $D \times 1$ l/min
Minimalny przepływ chłodziwa $D/2$ l/min
D = średnica wiertła
Minimalne zalecane ciśnienie chłodziwa 10 bar (145 PSI) przy $< 3 \times D$
Minimalne zalecane ciśnienie chłodziwa 20 bar (290 PSI) przy $> 3 \times D$
Minimalne zalecane ciśnienie chłodziwa 40 bar (580 PSI) przy $> 5 \times D$

Koncentracja emulsji
Zalecane koncentracja emulsji 6-8%.
Przy wierceniu w stali nierdz., superstopach i stali o dużej wytrzymałości zaleca się stężenie emulsji 10%.

Zalecenia dotyczące obróbki
Istnieje możliwość wiercenia pakietów zamocowanych w bezpieczny sposób, tak aby nie było szczelin między warstwami materiału. W szczeliny mogą wnikać wióry, w konsekwencji powodując zniszczenie wiertła.

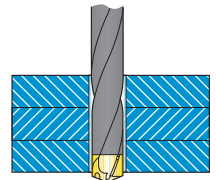

Tolerancja otworu/Gładkość powierzchni

SD101, SD103, SD105 i SD107 IT9-10 / R_a 1-4*, R_a 39-157 μm *					
Wiertło Ø DC (mm)	Tolerancja IT9 (μm)	Tolerancja IT10 (μm)	Wiertło Ø DC (cale)	Tolerancja IT9 (cale)	Tolerancja IT10 (cale)
0 – +10-18	0 – +43	0 – +70	0 – +0.394-0.709	0 – +0.0017	0 – +0.0028
0 – +18-30	0 – +52	0 – +84	0 – +0.709-1.181	0 – +0.0020	0 – +0.0033

*W przypadku wiercenia w stali niskowęglowej lub nierdzewnej może wystąpić pogorszenie chropowatości. Stosować możliwie najkrótsze wiertło w celu uzyskania otworu o najlepszej jakości.

Rozwiązywanie problemów - Co powinniśmy sprawdzić w pierwszej kolejności:

- Stabilność mocowania
- Stan techniczny wrzeciona
- Stan techniczny oprawki
- Zamocowanie narzędzia:
 - Bicie w granicach 0,06 (różnica skrajnych wskazań czujnika)

- Usuwanie wiórów:
 - Parametry skrawania
- Chłodzenie:
 - Ciśnienie
 - Wydatek
 - Koncentracja

Wykruszenie się krawędzi skrawających

- Zredukować posuw /obr.
- Jeśli wiertło drga, zredukować prędkość skrawania i zwiększyć posuw.
- Podczas wiercenia w surowej, twardej lub nachylonej powierzchni, zredukować posuw o 30%-50% na wejściu i wyjściu.

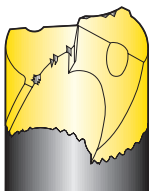

Zła tolerancja średnicy.

- Zwiększ posuw/obr.
- Zastosuj wiertło węglikowe Seco Feedmax, patrz str. 15-18
- Zastosuj operację rozwiercania, patrz str. 322
- Zastosuj operację wytaczania, patrz str. 492-493

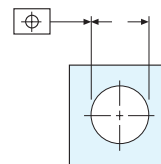

Zbyt szybkie zużycie się powierzchni przyłożenia

- Sprawdź czy użyto właściwej geometrii
- Zredukować prędkość skrawania

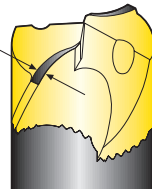

Zła gładkość powierzchni

- Zredukuj posuw/obr.
- Zwiększ prędkość skrawania
- Sprawdź czy zastosowano prawidłową geometrię
- Zastosuj wiertło węglikowe Seco Feedmax, patrz str. 15-18
- Zastosuj operację rozwiercania, patrz str. 322

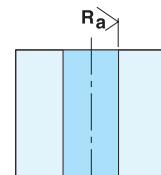

Zużycie się rowka

- Zredukować posuw/obr.
- Zredukować prędkość skrawania.
- Zwiększyć koncentrację chłodziwa.



Złe położenie otworu

- Zredukuj posuw/obr.
- Podczas wiercenia w surowej, twardej lub nachylonej powierzchni, zredukować posuw o 30%-50% na wejściu i wyjściu
- Nawiercić wstępnie wiertłem o kącie 140°.
- Zastosuj wiertło węglikowe Seco Feedmax, patrz str. 15-18
- Zastosuj operację wytaczania, patrz str. 492-493

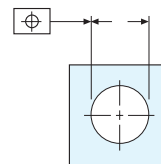

Zużycie zewnętrznej tyłki.

- Sprawdź czy użyto właściwej geometrii.
- Zredukuj prędkość skrawania.
- Zwiększ koncentrację chłodziwa.
- Podczas wiercenia w surowej, twardej lub nachylonej powierzchni, zredukuj posuw o 30%-50% na wejściu i wyjściu.

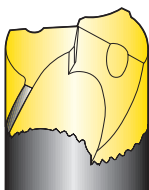

Zakleszczania długich wiórów

- Zwiększyć posuw
- Przy materiałach dających długi wiór, grupy mat. P1-P4, M1-M2:
 - Zwiększyć prędkość skrawania i zredukować posuw/obr.
 - Zastosować geometrię -L

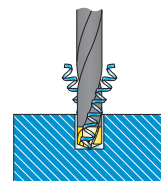

Złamanie wiertła na wyjściu z materiału

- Jeśli połączenie końcówki pęknie podczas wychodzenia z materiału. Problem spowodowany przez:
 - Połączenie między końcówką a korpusem wiertła nie zostało dobrze oczyszczone i nadal znajdują się zanieczyszczenia lub wióry.
 - Końcówka nie została prawidłowo zamocowana. Używaj klucza dynamometrycznego
 - Zbyt mała długość gwintu trzyma końcówkę

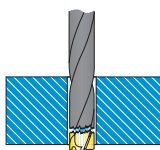

Wykruszenia powierzchni mocowania

- Drobne wykruszenia nie są niebezpieczne dla układu mocowania. Nie wpłyną na jakość otworu
- Jeśli występują spore wykruszenia przy dużym posuwie lub wierceniu pod kątem, należy zmniejszyć posuw.

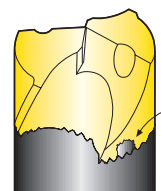



Crownloc® Plus

Seco Crownloc® Plus to nowa generacja wiertel Seco z wymiennymi końcówkami. Dzięki nowemu gniazdu Crownloc Plus poprawia usuwanie wiórów i odporność na zużycie w różnych materiałach.

- Mocna konstrukcja korpusu wiertła, wytrzymałe gniazdo z dużymi rowkami wiórowymi i polerowanym korpusem.
- Geometria P, mocna i uniwersalna, pierwszy wybór w ogólnych zastosowaniach.
- Geometria M zapewnia doskonałą wydajność w stopach żaroodpornych, tytanie, stopach tytanu i stali nierdzewnej

Przegląd asortymentu

Crownloc® Plus	Zakres \varnothing	Głębokość wiercenia	Tolerancja \varnothing otworu	Tolerancja otworu (1)	Wykończenie powierzchni (2)
<p>SD403</p>  <p>Str. - 201-204</p>	12,00-19,99 mm (0.472-0.787")	~ 3 x D	k7	IT 9-10	Ra 1-3 μm (Ra 39-118 μin)
<p>SD405</p>  <p>Str. - 205-208</p>	12,00-19,99 mm (0.472-0.787")	~ 5 x D	k7	IT 10	Ra 1-3 μm (Ra 39-118 μin)
<p>SD408</p>  <p>Str. - 209-212</p>	12,00-19,99 mm (0.472-0.787")	~ 8 x D	k7	IT 10	Ra 1-3 μm (Ra 39-118 μin)

1) mogą wystąpić różnice w zależności od materiału i stosowanych parametrów.

2) głębokość wiercenia, parametry, ciśnienie chłodziwa i materiał mogą spowodować pogorszenie wykończenia powierzchni.

Wstęp

Wiercenie

Rozwiercanie

Wytaczanie

Załącznik

Oznaczenia

Korpusy wiertel Crownloc® Plus

Metryczne

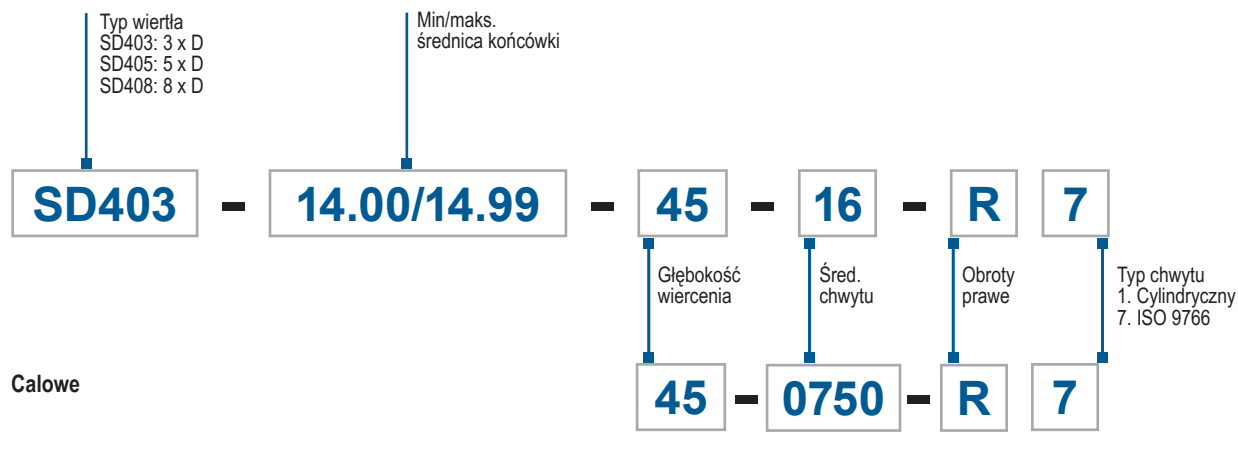

Wstęp

Wiercenie

Oznaczenia końcówki

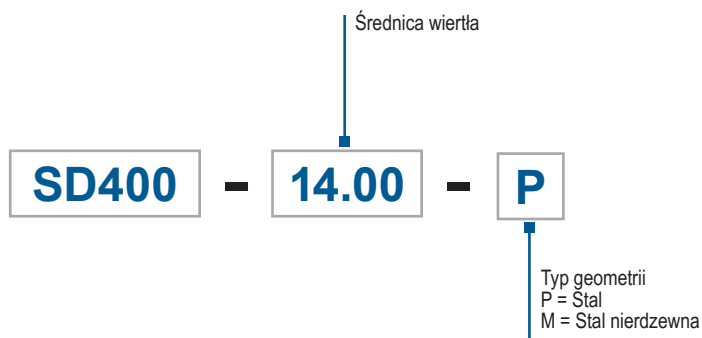

Rozwiercanie

Wytłaczanie

Załącznik

Geometrie

Geometria -P

- Geometria uniwersalna, pierwszy wybór do wiercenia w stali



Geometria -M

- Do stali nierdzewnych oraz stopów żaroodpornych



Wskazówki dotyczące mocowania

1. Stabilność

Stabilność obróbki bardzo mocno wpływa na trwałość ostrza oraz dokładność otworu. Należy sprawdzić stan wrzeciona obrabiarki, przyrządu oraz zamocowanie detalu dla zapewnienia maksymalnej stabilności i sztywności. Niestabilne warunki mogą spowodować złamanie narzędzia.

2. Zastosowania obrotowe

Całkowite zmierzone bicie (TIR) przy zast. obrotowym nie powinno przekraczać 0,06 mm (0.002"). Bicie należy zmierzyć obracając wiertło zamontowane we wrzecionie.

3. Zastosowania nieobrotowe

Odległość między środkiem wiertła a osią obracającego się detalu nie powinna być większa niż 0,03 mm (0.001") w przypadku pracy jako narzędzie nieobrotowe.

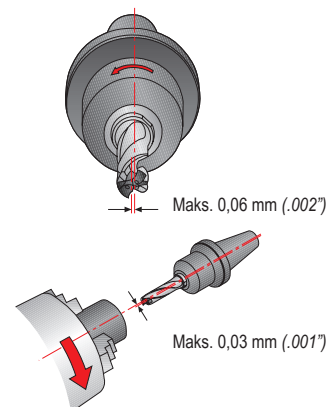

4. Zalecane oprawki

Firma Seco Tools oferuje szeroką gamę oprawek (tulejki zaciskowe, oprawki Shrinkfit, oprawki hydrauliczne Weldon...) dostępnych dla różnych typów wrzecion. Dla lepszych rezultatów, stosuj oprawki typu ERHP 5672, z precyzyjnym mocowaniem. Więcej informacji w katalogu Systemy Narzędziowe.



Oprawki na tulejki precyzyjne
(Tylko dla chwytów -R1 cylindrycznych)



Oprawki hydrauliczne
(Tylko dla chwytów -R1 cylindrycznych)



Weldon

1.

W celu odmocowania końcówki, załóż klucz na dwa spłaszczenia wykonane w końcówce.

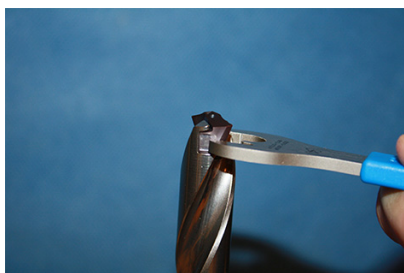

2.

Obróć klucz w kierunku przeciwnym do zegara o 1/4 obrotu.

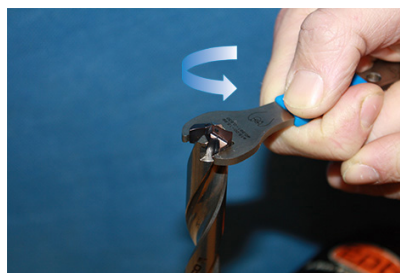

3.

Oczyść połączenie przed zamocowaniem nowej końcówki.

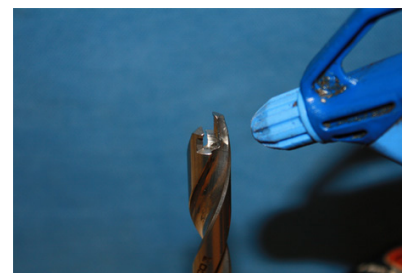

4.

Wstępnie zamocuj końcówkę palcami, przed użyciem klucza.

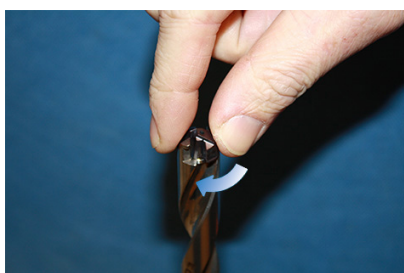

5.

Mocując końcówkę kluczem jednocześnie dociskaj ją do korpusu i obracaj klucz o 1/4 obrotu zgodnie z kierunkiem zegara trzymając go prostopadłe do wiertła.

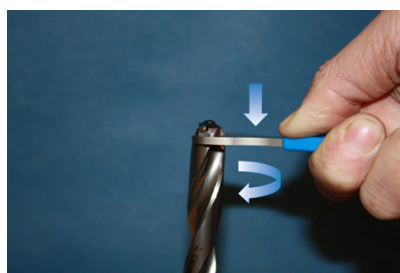

6.

Po zamocowaniu końcówki do korpusu, powierzchnie stykające się powinny mieć pełny kontakt, patrz rysunek.

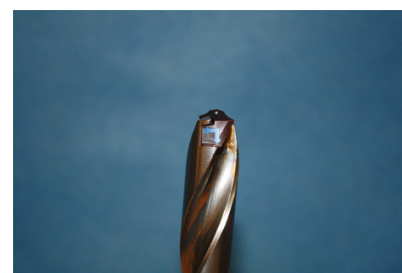

SD403 – R7

Głębokość wiercenia ~ 3 x D – Oprawka metryczna

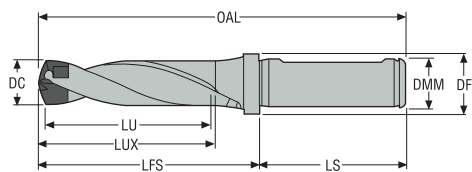

- Chłodzenie wewnętrzne
- ISO9766 do uchwyłów: Weldon 1835B, ISO 5414, DIN 60880
- Parametry skrawania, patrz strona (strony) 217

Oznaczenie	Numer produktu	DC	LU	OAL	LUX	LFS	LS	DMM	DF
		mm	mm	mm	mm	mm	mm	mm	mm
SD403-12.00/12.49-38-16R7	02622894	12,0-12,49	38,0	106,2	46,2	58,2	48,0	16,0	20,0
SD403-12.50/12.99-39-16R7	02622895	12,5-12,99	39,0	108,0	47,5	60,0	48,0	16,0	20,0
SD403-13.00/13.99-42-16R7	02622896	13,0-13,99	42,0	111,9	50,9	63,9	48,0	16,0	20,0
SD403-14.00/14.99-45-16R7	02622898	14,0-14,99	45,0	116,5	54,5	68,5	48,0	16,0	20,0
SD403-15.00/15.99-48-16R7	02622899	15,0-15,99	48,0	121,2	58,2	73,2	48,0	16,0	20,0
SD403-16.00/16.99-51-20R7	02622900	16,0-16,99	51,0	127,9	61,9	77,9	50,0	20,0	24,0
SD403-17.00/17.99-54-20R7	02622902	17,0-17,99	54,0	132,6	65,6	82,6	50,0	20,0	24,0
SD403-18.00/18.99-57-20R7	02622903	18,0-18,99	57,0	137,3	69,3	87,3	50,0	20,0	24,0
SD403-19.00/19.99-60-20R7	02622905	19,0-19,99	60,0	142,0	73,0	92,0	50,0	20,0	24,0

Akcesoria

Dla śred. wiertła (mm)	Klucz
	
12,00-12,99	SD400-K05
13,00-14,99	SD400-K06
15,00-16,99	SD400-K07
17,00-18,99	SD400-K08
19,00-19,99	SD400-K09

SD403 – R7

Głębokość wiercenia ~ 3 x D – Chwyć całowy

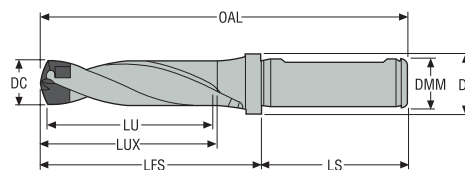

- Chłodzenie wewnętrzne
- ISO9766 do uchwytów: Weldon 1835B, ISO 5414, DIN 60880
- Parametry skrawania, patrz strona (strony) 217

Oznaczenie	Numer produktu	DC	LU	DF	OAL	LS	LFS	LUX	DMM
		<i>Cal.</i>	<i>Cal.</i>	<i>Cal.</i>	<i>Cal.</i>	<i>Cal.</i>	<i>Cal.</i>	<i>Cal.</i>	<i>Cal.</i>
SD403-12.00/12.49-38-0625R7	02622942	0.472-0.492	1.496	0.787	4.181	1.890	2.291	1.819	0.625
SD403-12.50/12.99-39-0625R7	02622943	0.492-0.511	1.535	0.787	4.252	1.890	2.362	1.870	0.625
SD403-13.00/13.99-42-0625R7	02622944	0.512-0.551	1.654	0.787	4.406	1.890	2.516	2.004	0.625
SD403-14.00/14.99-45-0625R7	02622945	0.551-0.590	1.772	0.787	4.587	1.890	2.697	2.146	0.625
SD403-15.00/15.99-48-0625R7	02622946	0.591-0.630	1.890	0.787	4.772	1.890	2.882	2.291	0.625
SD403-16.00/16.99-51-0750R7	02622947	0.630-0.669	2.008	0.945	5.035	1.969	3.067	2.437	0.750
SD403-17.00/17.99-54-0750R7	02622948	0.669-0.708	2.126	0.945	5.220	1.969	3.252	2.583	0.750
SD403-18.00/18.99-57-0750R7	02622949	0.709-0.748	2.244	0.945	5.406	1.969	3.437	2.728	0.750
SD403-19.00/19.99-60-0750R7	02622950	0.748-0.787	2.362	0.945	5.591	1.969	3.622	2.874	0.750

Akcesoria

Dla śred. wiertła
(cale)

Klucz



0.472-0.511	SD400-K05
0.512-0.590	SD400-K06
0.591-0.669	SD400-K07
0.669-0.748	SD400-K08
0.748-0.787	SD400-K09

SD403 – R1

Głębokość wiercenia ~ 3 x D – Oprawka metryczna

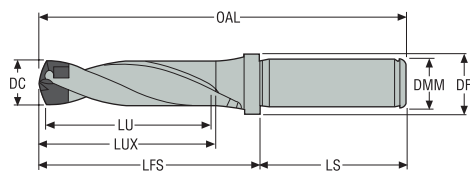

- Chłodzenie wewnętrzne
- Chwyt cylindryczny (R1) pasuje do oprawek: 5834 i 5672
- Parametry skrawania, patrz strona (strony) 217

Oznaczenie	Numer produktu	DC	LU	OAL	LUX	LFS	LS	DMM	DF
		mm	mm	mm	mm	mm	mm	mm	mm
SD403-12.00/12.49-38-16R1	02622920	12,0-12,49	38,0	106,2	46,2	58,2	48,0	16,0	20,0
SD403-12.50/12.99-39-16R1	02622921	12,5-12,99	39,0	108,0	47,5	60,0	48,0	16,0	20,0
SD403-13.00/13.99-42-16R1	02622922	13,0-13,99	42,0	111,9	50,9	63,9	48,0	16,0	20,0
SD403-14.00/14.99-45-16R1	02622923	14,0-14,99	45,0	116,5	54,5	68,5	48,0	16,0	20,0
SD403-15.00/15.99-48-16R1	02622924	15,0-15,99	48,0	121,2	58,2	73,2	48,0	16,0	20,0
SD403-16.00/16.99-51-20R1	02622927	16,0-16,99	51,0	127,9	61,9	77,9	50,0	20,0	24,0
SD403-17.00/17.99-54-20R1	02622928	17,0-17,99	54,0	132,6	65,6	82,6	50,0	20,0	24,0
SD403-18.00/18.99-57-20R1	02622930	18,0-18,99	57,0	137,3	69,3	87,3	50,0	20,0	24,0
SD403-19.00/19.99-60-20R1	02622931	19,0-19,99	60,0	142,0	73,0	92,0	50,0	20,0	24,0

Akcesoria

Dla śred. wiertła (mm)	Klucz
	
12,00-12,99	SD400-K05
13,00-14,99	SD400-K06
15,00-16,99	SD400-K07
17,00-18,99	SD400-K08
19,00-19,99	SD400-K09

SD403 – R1

Głębokość wiercenia ~ 3 x D – Chwyć calowy

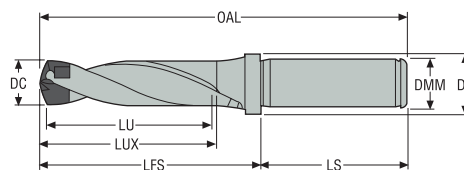

- Chłodzenie wewnętrzne
- Chwyć cylindryczny (R1) pasuje do opravek: 5834 i 5672
- Parametry skrawania, patrz strona (strony) 217

Oznaczenie	Numer produktu	DC	LU	DF	OAL	LS	LFS	LUX	DMM
		<i>Cal.</i>	<i>Cal.</i>	<i>Cal.</i>	<i>Cal.</i>	<i>Cal.</i>	<i>Cal.</i>	<i>Cal.</i>	<i>Cal.</i>
SD403-12.00/12.49-38-0625R1	02623538	0.472-0.492	1.496	0.787	4.181	1.890	2.291	1.819	0.625
SD403-12.50/12.99-39-0625R1	02623539	0.492-0.511	1.535	0.787	4.252	1.890	2.362	1.870	0.625
SD403-13.00/13.99-42-0625R1	02623540	0.512-0.551	1.654	0.787	4.406	1.890	2.516	2.004	0.625
SD403-14.00/14.99-45-0625R1	02623541	0.551-0.590	1.772	0.787	4.587	1.890	2.697	2.146	0.625
SD403-15.00/15.99-48-0625R1	02623542	0.591-0.630	1.890	0.787	4.772	1.890	2.882	2.291	0.625
SD403-16.00/16.99-51-0750R1	02623543	0.630-0.669	2.008	0.945	5.035	1.969	3.067	2.437	0.750
SD403-17.00/17.99-54-0750R1	02623544	0.669-0.708	2.126	0.945	5.220	1.969	3.252	2.583	0.750
SD403-18.00/18.99-57-0750R1	02623545	0.709-0.748	2.244	0.945	5.406	1.969	3.437	2.728	0.750
SD403-19.00/19.99-60-0750R1	02623546	0.748-0.787	2.362	0.945	5.591	1.969	3.622	2.874	0.750

Akcesoria

Dla śred. wiertła (cale)	Klucz
0.472-0.511	SD400-K05
0.512-0.590	SD400-K06
0.591-0.669	SD400-K07
0.669-0.748	SD400-K08
0.748-0.787	SD400-K09



Wstęp

Wiercenie

Rozwiercanie

Wytaczanie

Załącznik

SD405 – R7

Głębokość wiercenia ~ 5 x D – Oprawka metryczna

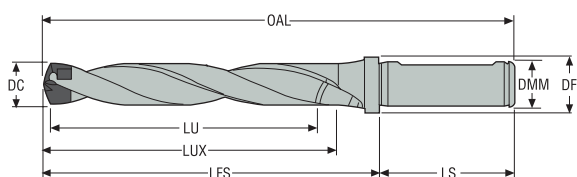

- Chłodzenie wewnętrzne
- ISO9766 do uchwytów: Weldon 1835B, ISO 5414, DIN 60880
- Parametry skrawania, patrz strona (strony) 218

Oznaczenie	Numer produktu	DC	LU	OAL	LUX	LFS	LS	DMM	DF
		mm	mm	mm	mm	mm	mm	mm	mm
SD405-12.00/12.49-63-16R7	02623554	12,0-12,49	63,0	131,2	71,2	83,2	48,0	16,0	20,0
SD405-12.50/12.99-65-16R7	02623555	12,5-12,99	65,0	134,0	73,5	86,0	48,0	16,0	20,0
SD405-13.00/13.99-70-16R7	02623556	13,0-13,99	70,0	139,9	78,9	91,9	48,0	16,0	20,0
SD405-14.00/14.99-75-16R7	02623557	14,0-14,99	75,0	146,5	84,5	98,5	48,0	16,0	20,0
SD405-15.00/15.99-80-16R7	02623558	15,0-15,99	80,0	153,2	90,2	105,2	48,0	16,0	20,0
SD405-16.00/16.99-85-20R7	02623559	16,0-16,99	85,0	161,9	95,9	111,9	50,0	20,0	24,0
SD405-17.00/17.99-90-20R7	02623560	17,0-17,99	90,0	168,6	101,6	118,6	50,0	20,0	24,0
SD405-18.00/18.99-95-20R7	02623561	18,0-18,99	95,0	175,3	107,3	125,3	50,0	20,0	24,0
SD405-19.00/19.99-100-20R7	02623562	19,0-19,99	100,0	182,0	113,0	132,0	50,0	20,0	24,0

Akcesoria

Dla śred. wiertła (mm)	Klucz
12,00-12,99	SD400-K05
13,00-14,99	SD400-K06
15,00-16,99	SD400-K07
17,00-18,99	SD400-K08
19,00-19,99	SD400-K09

SD405 – R7

Głębokość wiercenia ~ 5 x D – Chwyt całowy

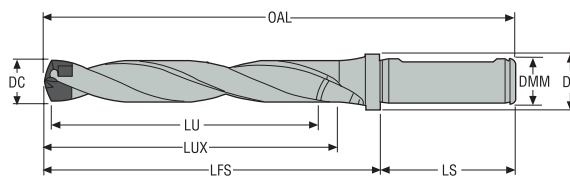

- Chłodzenie wewnętrzne
- ISO9766 do uchwytów: Weldon 1835B, ISO 5414, DIN 60880
- Parametry skrawania, patrz strona (strony) 218

Oznaczenie	Numer produktu	DC	LU	DF	OAL	LS	LFS	LUX	DMM
		<i>Cal.</i>	<i>Cal.</i>	<i>Cal.</i>	<i>Cal.</i>	<i>Cal.</i>	<i>Cal.</i>	<i>Cal.</i>	<i>Cal.</i>
SD405-12.00/12.49-63-0625R7	02623586	0.472-0.492	2.480	0.787	5.165	1.890	3.276	2.803	0.625
SD405-12.50/12.99-65-0625R7	02623587	0.492-0.511	2.559	0.787	5.276	1.890	3.386	2.894	0.625
SD405-13.00/13.99-70-0625R7	02623588	0.512-0.551	2.756	0.787	5.508	1.890	3.618	3.106	0.625
SD405-14.00/14.99-75-0625R7	02623589	0.551-0.590	2.953	0.787	5.768	1.890	3.878	3.327	0.625
SD405-15.00/15.99-80-0625R7	02623590	0.591-0.630	3.150	0.787	6.031	1.890	4.142	3.551	0.625
SD405-16.00/16.99-85-0750R7	02623591	0.630-0.669	3.346	0.945	6.374	1.969	4.406	3.776	0.750
SD405-17.00/17.99-90-0750R7	02623592	0.669-0.708	3.543	0.945	6.638	1.969	4.669	4.000	0.750
SD405-18.00/18.99-95-0750R7	02623593	0.709-0.748	3.740	0.945	6.902	1.969	4.933	4.224	0.750
SD405-19.00/19.99-100-0750R7	02623594	0.748-0.787	3.937	0.945	7.165	1.969	5.197	4.449	0.750

Akcesoria

Dla śred. wiertła (cale)	Klucz
0.472-0.511	SD400-K05
0.512-0.590	SD400-K06
0.591-0.669	SD400-K07
0.669-0.748	SD400-K08
0.748-0.787	SD400-K09



Wstęp

Wiercenie

Rozwiercanie

Wytaczanie

Załącznik

SD405 – R1

Głębokość wiercenia ~ 5 x D – Oprawka metryczna

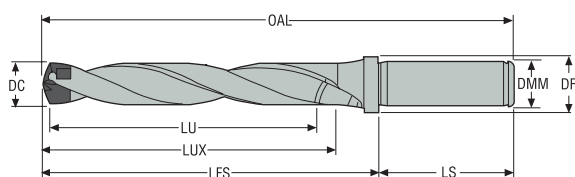

- Chłodzenie wewnętrzne
- Chwyt cylindryczny (R1) pasuje do oprawek: 5834 i 5672
- Parametry skrawania, patrz strona (strony) 218

Oznaczenie	Numer produktu	DC	LU	OAL	LUX	LFS	LS	DMM	DF
		mm	mm	mm	mm	mm	mm	mm	mm
SD405-12.00/12.49-63-16R1	02623570	12,0-12,49	63,0	131,2	71,2	83,2	48,0	16,0	20,0
SD405-12.50/12.99-65-16R1	02623571	12,5-12,99	65,0	134,0	73,5	86,0	48,0	16,0	20,0
SD405-13.00/13.99-70-16R1	02623572	13,0-13,99	70,0	139,9	78,9	91,9	48,0	16,0	20,0
SD405-14.00/14.99-75-16R1	02623573	14,0-14,99	75,0	146,5	84,5	98,5	48,0	16,0	20,0
SD405-15.00/15.99-80-16R1	02623574	15,0-15,99	80,0	153,2	90,2	105,2	48,0	16,0	20,0
SD405-16.00/16.99-85-20R1	02623575	16,0-16,99	85,0	161,9	95,9	111,9	50,0	20,0	24,0
SD405-17.00/17.99-90-20R1	02623576	17,0-17,99	90,0	168,6	101,6	118,6	50,0	20,0	24,0
SD405-18.00/18.99-95-20R1	02623577	18,0-18,99	95,0	175,3	107,3	125,3	50,0	20,0	24,0
SD405-19.00/19.99-100-20R1	02623578	19,0-19,99	100,0	182,0	113,0	132,0	50,0	20,0	24,0

Akcesoria

Dla śred. wiertła (mm)	Klucz
	
12,00-12,99	SD400-K05
13,00-14,99	SD400-K06
15,00-16,99	SD400-K07
17,00-18,99	SD400-K08
19,00-19,99	SD400-K09

SD405 – R1

Głębokość wiercenia ~ 5 x D – Chwył calowy

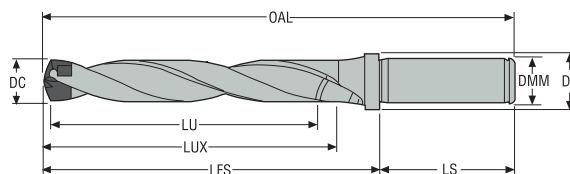

- Chłodzenie wewnętrzne
- Chwył cylindryczny (R1) pasuje do opravek: 5834 i 5672
- Parametry skrawania, patrz strona (strony) 218

Oznaczenie	Numer produktu	DC	LU	DF	OAL	LS	LFS	LUX	DMM
		<i>Cal.</i>	<i>Cal.</i>	<i>Cal.</i>	<i>Cal.</i>	<i>Cal.</i>	<i>Cal.</i>	<i>Cal.</i>	<i>Cal.</i>
SD405-12.00/12.49-63-0625R1	02623603	0.472-0.492	2.480	0.787	5.165	1.890	3.276	2.803	0.625
SD405-12.50/12.99-65-0625R1	02623604	0.492-0.511	2.559	0.787	5.276	1.890	3.386	2.894	0.625
SD405-13.00/13.99-70-0625R1	02623605	0.512-0.551	2.756	0.787	5.508	1.890	3.618	3.106	0.625
SD405-14.00/14.99-75-0625R1	02623606	0.551-0.590	2.953	0.787	5.768	1.890	3.878	3.327	0.625
SD405-15.00/15.99-80-0625R1	02623607	0.591-0.630	3.150	0.787	6.031	1.890	4.142	3.551	0.625
SD405-16.00/16.99-85-0750R1	02623608	0.630-0.669	3.346	0.945	6.374	1.969	4.406	3.776	0.750
SD405-17.00/17.99-90-0750R1	02623609	0.669-0.708	3.543	0.945	6.638	1.969	4.669	4.000	0.750
SD405-18.00/18.99-95-0750R1	02623610	0.709-0.748	3.740	0.945	6.902	1.969	4.933	4.224	0.750
SD405-19.00/19.99-100-0750R1	02623611	0.748-0.787	3.937	0.945	7.165	1.969	5.197	4.449	0.750

Akcesoria

Dla śred. wiertła (cale)	Klucz
0.472-0.511	SD400-K05
0.512-0.590	SD400-K06
0.591-0.669	SD400-K07
0.669-0.748	SD400-K08
0.748-0.787	SD400-K09



SD408 – R7

Głębokość wiercenia ~ 8 x D – Oprawka metryczna

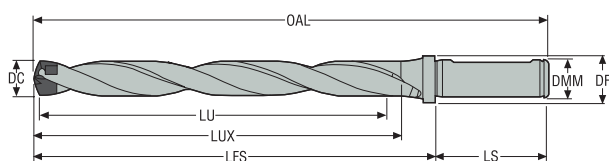

- Chłodzenie wewnętrzne
- ISO9766 do uchwytów: Weldon 1835B, ISO 5414, DIN 60880
- Parametry skrawania, patrz strona (strony) 219

Oznaczenie	Numer produktu	DC	LU	OAL	LUX	LFS	LS	DMM	DF
		mm	mm	mm	mm	mm	mm	mm	mm
SD408-12.00/12.49-100-16R7	02623615	12,0-12,49	100,0	168,2	108,2	120,2	48,0	16,0	20,0
SD408-12.50/12.99-104-16R7	02623616	12,5-12,99	104,0	173,0	112,5	125,0	48,0	16,0	20,0
SD408-13.00/13.99-112-16R7	02623617	13,0-13,99	112,0	181,9	120,9	133,9	48,0	16,0	20,0
SD408-14.00/14.99-120-16R7	02623618	14,0-14,99	120,0	191,5	129,5	143,5	48,0	16,0	20,0
SD408-15.00/15.99-128-16R7	02623619	15,0-15,99	128,0	201,2	138,2	153,2	48,0	16,0	20,0
SD408-16.00/16.99-136-20R7	02623620	16,0-16,99	136,0	212,9	146,9	162,9	50,0	20,0	24,0
SD408-17.00/17.99-144-20R7	02623621	17,0-17,99	144,0	222,6	155,6	172,6	50,0	20,0	24,0
SD408-18.00/18.99-152-20R7	02623622	18,0-18,99	152,0	232,3	164,3	182,3	50,0	20,0	24,0
SD408-19.00/19.99-160-20R7	02623623	19,0-19,99	160,0	242,0	173,0	192,0	50,0	20,0	24,0

Akcesoria

Dla śred. wiertła (mm)	Klucz
	
12,00-12,99	SD400-K05
13,00-14,99	SD400-K06
15,00-16,99	SD400-K07
17,00-18,99	SD400-K08
19,00-19,99	SD400-K09

SD408 – R7

Głębokość wiercenia ~ 8 x D – Chwyt całowy

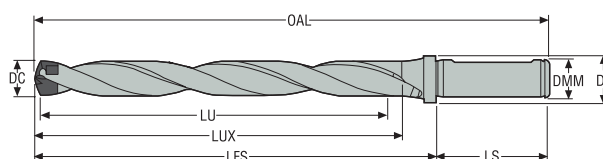

- Chłodzenie wewnętrzne
- ISO9766 do uchwytów: Weldon 1835B, ISO 5414, DIN 60880
- Parametry skrawania, patrz strona (strony) 219

Oznaczenie	Numer produktu	DC	LU	DF	OAL	LS	LFS	LUX	DMM
		<i>Cal.</i>	<i>Cal.</i>	<i>Cal.</i>	<i>Cal.</i>	<i>Cal.</i>	<i>Cal.</i>	<i>Cal.</i>	<i>Cal.</i>
SD408-12.00/12.49-100-0625R7	02623639	0.472-0.492	3.937	0.787	6.622	1.890	4.732	4.260	0.625
SD408-12.50/12.99-104-0625R7	02623640	0.492-0.511	4.094	0.787	6.811	1.890	4.921	4.429	0.625
SD408-13.00/13.99-112-0625R7	02623641	0.512-0.551	4.409	0.787	7.161	1.890	5.272	4.760	0.625
SD408-14.00/14.99-120-0625R7	02623642	0.551-0.590	4.724	0.787	7.539	1.890	5.650	5.098	0.625
SD408-15.00/15.99-128-0625R7	02623643	0.591-0.630	5.039	0.787	7.921	1.890	6.031	5.441	0.625
SD408-16.00/16.99-136-0750R7	02623644	0.630-0.669	5.354	0.945	8.382	1.969	6.413	5.783	0.750
SD408-17.00/17.99-144-0750R7	02623645	0.669-0.708	5.669	0.945	8.764	1.969	6.795	6.126	0.750
SD408-18.00/18.99-152-0750R7	02623646	0.709-0.748	5.984	0.945	9.146	1.969	7.177	6.469	0.750
SD408-19.00/19.99-160-0750R7	02623647	0.748-0.787	6.299	0.945	9.528	1.969	7.559	6.811	0.750

Akcesoria

Dla śred. wiertła
(cale)

Klucz



0.472-0.511	SD400-K05
0.512-0.590	SD400-K06
0.591-0.669	SD400-K07
0.669-0.748	SD400-K08
0.748-0.787	SD400-K09

SD408 – R1

Głębokość wiercenia ~ 8 x D – Oprawka metryczna

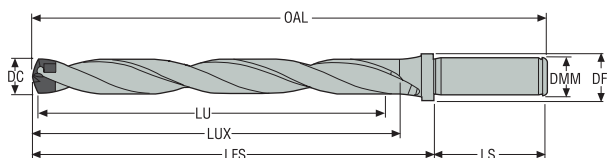

- Chłodzenie wewnętrzne
- Chwyt cylindryczny (R1) pasuje do oprawek: 5834 i 5672
- Parametry skrawania, patrz strona (strony) 219

Oznaczenie	Numer produktu	DC	LU	OAL	LUX	LFS	LS	DMM	DF
		mm	mm	mm	mm	mm	mm	mm	mm
SD408-12.00/12.49-100-16R1	02623627	12,0-12,49	100,0	168,2	108,2	120,2	48,0	16,0	20,0
SD408-12.50/12.99-104-16R1	02623628	12,5-12,99	104,0	173,0	112,5	125,0	48,0	16,0	20,0
SD408-13.00/13.99-112-16R1	02623629	13,0-13,99	112,0	181,9	120,9	133,9	48,0	16,0	20,0
SD408-14.00/14.99-120-16R1	02623630	14,0-14,99	120,0	191,5	129,5	143,5	48,0	16,0	20,0
SD408-15.00/15.99-128-16R1	02623631	15,0-15,99	128,0	201,2	138,2	153,2	48,0	16,0	20,0
SD408-16.00/16.99-136-20R1	02623632	16,0-16,99	136,0	212,9	146,9	162,9	50,0	20,0	24,0
SD408-17.00/17.99-144-20R1	02623633	17,0-17,99	144,0	222,6	155,6	172,6	50,0	20,0	24,0
SD408-18.00/18.99-152-20R1	02623634	18,0-18,99	152,0	232,3	164,3	182,3	50,0	20,0	24,0
SD408-19.00/19.99-160-20R1	02623635	19,0-19,99	160,0	242,0	173,0	192,0	50,0	20,0	24,0

Akcesoria

Dla śred. wiertła (mm)	Klucz
	
12,00-12,99	SD400-K05
13,00-14,99	SD400-K06
15,00-16,99	SD400-K07
17,00-18,99	SD400-K08
19,00-19,99	SD400-K09

SD408 – R1

Głębokość wiercenia ~ 8 x D – Chwył calowy

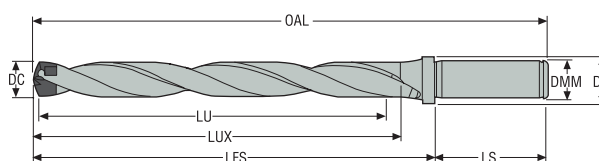

- Chłodzenie wewnętrzne
- Chwył cylindryczny (R1) pasuje do opravek: 5834 i 5672
- Parametry skrawania, patrz strona (strony) 219

Oznaczenie	Numer produktu	DC	LU	DF	OAL	LS	LFS	LUX	DMM
		<i>Cal.</i>	<i>Cal.</i>	<i>Cal.</i>	<i>Cal.</i>	<i>Cal.</i>	<i>Cal.</i>	<i>Cal.</i>	<i>Cal.</i>
SD408-12.00/12.49-100-0625R1	02623651	0.472-0.492	3.937	0.787	6.622	1.890	4.732	4.260	0.625
SD408-12.50/12.99-104-0625R1	02623652	0.492-0.511	4.094	0.787	6.811	1.890	4.921	4.429	0.625
SD408-13.00/13.99-112-0625R1	02623653	0.512-0.551	4.409	0.787	7.161	1.890	5.272	4.760	0.625
SD408-14.00/14.99-120-0625R1	02623654	0.551-0.590	4.724	0.787	7.539	1.890	5.650	5.098	0.625
SD408-15.00/15.99-128-0625R1	02623655	0.591-0.630	5.039	0.787	7.921	1.890	6.031	5.441	0.625
SD408-16.00/16.99-136-0750R1	02623656	0.630-0.669	5.354	0.945	8.382	1.969	6.413	5.783	0.750
SD408-17.00/17.99-144-0750R1	02623657	0.669-0.708	5.669	0.945	8.764	1.969	6.795	6.126	0.750
SD408-18.00/18.99-152-0750R1	02623658	0.709-0.748	5.984	0.945	9.146	1.969	7.177	6.469	0.750
SD408-19.00/19.99-160-0750R1	02623659	0.748-0.787	6.299	0.945	9.528	1.969	7.559	6.811	0.750

Akcesoria

Dla śred. wiertła (cale)	Klucz
0.472-0.511	SD400-K05
0.512-0.590	SD400-K06
0.591-0.669	SD400-K07
0.669-0.748	SD400-K08
0.748-0.787	SD400-K09



Moduł fazujący

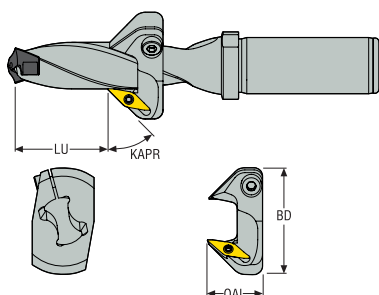

Oznaczenie	Numer produktu	Do korpusu wiertła	Głębokość wiercenia LU						Maks. głębokość fazy (mm)	OAL	BD	KAPR°
			SD403 (min-max)		SD405 (min-max)		SD408 (min-max)					
			mm	Cal.	mm	Cal.	mm	Cal.				
SD400-C45-12.00/12.49	02846075	SD40x-12.00/12.49	6,0 0.236	22,0 0.866	6,0 0.236	47,0 1.850	47,0 1.850	84,0 3.307	1,5 0.059	20,0 0.787	34,0 1.339	45
SD400-C45-12.50/12.99	02846076	SD40x-12.50/12.99	7,0 0.276	23,0 0.906	7,0 0.276	48,0 1.890	48,0 1.890	88,0 3.465	1,5 0.059	20,0 0.787	34,0 1.339	45
SD400-C45-13.00/13.99	02846077	SD40x-13.00/13.99	7,0 0.276	27,0 1.063	7,0 0.276	55,0 2.165	55,0 2.165	97,0 3.819	1,5 0.059	20,0 0.787	34,0 1.339	45
SD400-C45-14.00/14.99	02846078	SD40x-14.00/14.99	7,0 0.276	33,0 1.299	7,0 0.276	60,0 2.362	60,0 2.362	105,0 4.134	1,5 0.059	20,0 0.787	36,0 1.417	45
SD400-C45-15.00/15.99	02846079	SD40x-15.00/15.99	8,0 0.315	35,0 1.378	8,0 0.315	67,0 2.638	67,0 2.638	114,0 4.488	1,5 0.059	20,0 0.787	36,0 1.417	45
SD400-C45-16.00/16.99	02846080	SD40x-16.00/16.99	8,0 0.315	38,0 1.496	8,0 0.315	72,0 2.835	72,0 2.835	123,0 4.843	1,5 0.059	20,0 0.787	38,0 1.496	45
SD400-C45-17.00/17.99	02846117	SD40x-17.00/17.99	9,0 0.354	43,0 1.693	9,0 0.354	79,0 3.110	79,0 3.110	132,0 5.197	1,5 0.059	20,0 0.787	38,0 1.496	45
SD400-C45-18.00/18.99	02846082	SD40x-18.00/18.99	9,0 0.354	45,0 1.772	9,0 0.354	83,0 3.268	83,0 3.268	140,0 5.512	1,5 0.059	20,0 0.787	40,0 1.575	45
SD400-C45-19.00/19.99	02846083	SD40x-19.00/19.99	10,0 0.394	49,0 1.929	10,0 0.394	89,0 3.504	89,0 3.504	149,0 5.866	1,5 0.059	20,0 0.787	40,0 1.575	45

Części zamienne, zawarte w dostawie

Dla śred. wiertła (mm)	Klucz do płytek	Śruba mocująca płytkę	Klucz mocujący	Klucz mocujący	Śruba mocująca 1	Śruba mocująca 2
SD400-C45...	T07P-2	C02505-T07P	2SMS795	3SMS795	MC6S4X8	P6SS4X8

Płytki

Tolerancje: mm/cal.	Wielkość	L mm/cal.	EPSR	RE mm/cal.	IC mm/cal.	D1 mm/cal.	AN	S mm/cal.
IC = ±0,025/0.0009842 S = ±0,07/0.0027559 RE = ±0,10/0.0039370	09	9,0/ 2187	35°	0,2/ 0078	5,556/ 2187	2,9/ 1141	7°	2,5/ 0984
	Gatunek: T400D							
	Oznaczenie: VCGX090202-D1							
	Numer produktu: 00014948							

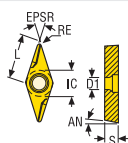

Końcówki – Geometria -P i -M

Kąt wierzchołkowy 140°

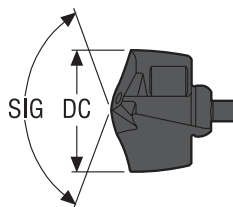

Oznaczenie	Numer produktu	Geometria P	Geometria M	DC	
				mm	cal.
SD400-12.00-M	02826210	-	■	12,0	0.472
SD400-12.00-P	02630908	■	-	12,0	0.472
SD400-12.10-P	02630910	■	-	12,1	0.476
SD400-12.20-P	02630911	■	-	12,2	0.480
SD400-12.30-M	02826211	-	■	12,3	0.484
SD400-12.30-P	02630912	■	-	12,3	0.484
SD400-12.41-M	02826212	-	■	12,41	0.489
SD400-12.41-P	02630913	■	-	12,41	0.489
SD400-12.50-M	02826213	-	■	12,5	0.492
SD400-12.50-P	02630915	■	-	12,5	0.492
SD400-12.60-P	02630916	■	-	12,6	0.496
SD400-12.70-M	02826214	-	■	12,7	0.500
SD400-12.70-P	02630917	■	-	12,7	0.500
SD400-12.80-M	02826215	-	■	12,8	0.504
SD400-12.80-P	02630918	■	-	12,8	0.504
SD400-12.90-M	02826216	-	■	12,9	0.508
SD400-12.90-P	02630919	■	-	12,9	0.508
SD400-13.00-M	02826217	-	■	13,0	0.512
SD400-13.00-P	02634577	■	-	13,0	0.512
SD400-13.10-M	02826218	-	■	13,1	0.516
SD400-13.10-P	02634578	■	-	13,1	0.516
SD400-13.20-P	02634579	■	-	13,2	0.520
SD400-13.30-M	02826219	-	■	13,3	0.524
SD400-13.30-P	02634580	■	-	13,3	0.524
SD400-13.50-M	02826220	-	■	13,5	0.531
SD400-13.50-P	02634581	■	-	13,5	0.531
SD400-13.70-M	02826221	-	■	13,7	0.539
SD400-13.70-P	02634582	■	-	13,7	0.539
SD400-13.80-M	02826222	-	■	13,8	0.543
SD400-13.80-P	02634583	■	-	13,8	0.543
SD400-13.89-M	02826223	-	■	13,89	0.547
SD400-13.89-P	02634584	■	-	13,89	0.547
SD400-14.00-M	02826224	-	■	14,0	0.551
SD400-14.00-P	02634589	■	-	14,0	0.551
SD400-14.10-P	02634590	■	-	14,1	0.555
SD400-14.20-M	02826225	-	■	14,2	0.559
SD400-14.20-P	02634591	■	-	14,2	0.559
SD400-14.288-M	02826226	-	■	14,29	0.563
SD400-14.288-P	02634592	■	-	14,288	0.563
SD400-14.40-P	02634593	■	-	14,4	0.567

Oznaczenie	Numer produktu	Geometria P	Geometria M	DC	
				mm	cal.
SD400-14.50-M	02826227	-	■	14,5	0.571
SD400-14.50-P	02634594	■	-	14,5	0.571
SD400-14.68-M	02826228	-	■	14,68	0.578
SD400-14.68-P	02634595	■	-	14,68	0.578
SD400-14.70-M	02826229	-	■	14,7	0.579
SD400-14.70-P	02634596	■	-	14,7	0.579
SD400-14.80-M	02826230	-	■	14,8	0.583
SD400-14.80-P	02634597	■	-	14,8	0.583
SD400-14.90-M	02826231	-	■	14,9	0.587
SD400-14.90-P	02634598	■	-	14,9	0.587
SD400-15.00-M	02826232	-	■	15,0	0.591
SD400-15.00-P	02634599	■	-	15,0	0.591
SD400-15.08-M	02826233	-	■	15,08	0.594
SD400-15.08-P	02634600	■	-	15,08	0.594
SD400-15.10-P	02634601	■	-	15,1	0.594
SD400-15.20-P	02634602	■	-	15,2	0.598
SD400-15.25-M	02826234	-	■	15,25	0.600
SD400-15.25-P	02634603	■	-	15,25	0.600
SD400-15.478-M	02826235	-	■	15,48	0.609
SD400-15.478-P	02634604	■	-	15,478	0.609
SD400-15.50-M	02826236	-	■	15,5	0.610
SD400-15.50-P	02634605	■	-	15,5	0.610
SD400-15.70-M	02826237	-	■	15,7	0.618
SD400-15.70-P	02634607	■	-	15,7	0.618
SD400-15.80-M	02826238	-	■	15,8	0.622
SD400-15.80-P	02634608	■	-	15,8	0.622
SD400-15.875-M	02826239	-	■	15,88	0.625
SD400-15.875-P	02634609	■	-	15,875	0.625
SD400-16.00-M	02826240	-	■	16,0	0.630
SD400-16.00-P	02635956	■	-	16,0	0.630
SD400-16.10-P	02635957	■	-	16,1	0.634
SD400-16.20-P	02635958	■	-	16,2	0.638
SD400-16.25-P	02635959	■	-	16,25	0.640
SD400-16.27-M	02826241	-	■	16,27	0.641
SD400-16.27-P	02635960	■	-	16,27	0.641
SD400-16.40-P	02635962	■	-	16,4	0.646
SD400-16.50-M	02826242	-	■	16,5	0.650
SD400-16.50-P	02635963	■	-	16,5	0.650
SD400-16.669-M	02826243	-	■	16,67	0.656
SD400-16.669-P	02635964	■	-	16,669	0.656
SD400-16.70-M	02826244	-	■	16,7	0.657
SD400-16.70-P	02635966	■	-	16,7	0.657
SD400-16.80-M	02826245	-	■	16,8	0.661
SD400-16.80-P	02635968	■	-	16,8	0.661
SD400-16.90-P	02635969	■	-	16,9	0.665
SD400-17.00-M	02826246	-	■	17,0	0.669
SD400-17.00-P	02635970	■	-	17,0	0.669
SD400-17.065-M	02826247	-	■	17,07	0.672
SD400-17.065-P	02635972	■	-	17,065	0.672
SD400-17.10-P	02635973	■	-	17,1	0.673
SD400-17.20-P	02635974	■	-	17,2	0.677
SD400-17.35-P	02888828	■	-	17,35	0.683

Wstęp

Wiercenie

Rozwiercanie

Wylaczanie

Załącznik

Oznaczenie	Numer produktu	Geometria P	Geometria M	DC	
				mm	cal.
SD400-17.463-M	02826248	-	■	17,46	0.687
SD400-17.463-P	02635975	■	-	17,463	0.688
SD400-17.50-M	02826249	-	■	17,5	0.689
SD400-17.50-P	02635976	■	-	17,5	0.689
SD400-17.70-M	02826250	-	■	17,7	0.697
SD400-17.70-P	02635977	■	-	17,7	0.697
SD400-17.80-M	02826251	-	■	17,8	0.701
SD400-17.80-P	02635978	■	-	17,8	0.701
SD400-17.859-M	02826252	-	■	17,86	0.703
SD400-17.859-P	02635979	■	-	17,859	0.703
SD400-17.90-M	02826253	-	■	17,9	0.705
SD400-17.90-P	02635980	■	-	17,9	0.705
SD400-18.00-M	02826254	-	■	18,0	0.709
SD400-18.00-P	02635981	■	-	18,0	0.709
SD400-18.10-P	02635982	■	-	18,1	0.713
SD400-18.20-P	02635983	■	-	18,2	0.717
SD400-18.256-M	02826255	-	■	18,26	0.719
SD400-18.256-P	02635984	■	-	18,256	0.719
SD400-18.50-M	02826256	-	■	18,5	0.728
SD400-18.50-P	02635985	■	-	18,5	0.728
SD400-18.653-M	02826257	-	■	18,65	0.734
SD400-18.653-P	02635986	■	-	18,653	0.734
SD400-18.70-M	02826258	-	■	18,7	0.736
SD400-18.70-P	02635987	■	-	18,7	0.736
SD400-18.80-M	02826259	-	■	18,8	0.740
SD400-18.80-P	02635988	■	-	18,8	0.740
SD400-18.90-M	02826260	-	■	18,9	0.744
SD400-18.90-P	02635989	■	-	18,9	0.744
SD400-19.00-M	02826261	-	■	19,0	0.748
SD400-19.00-P	02635991	■	-	19,0	0.748
SD400-19.05-M	02826262	-	■	19,05	0.750
SD400-19.05-P	02635992	■	-	19,05	0.750
SD400-19.10-P	02635993	■	-	19,1	0.752
SD400-19.20-M	02826263	-	■	19,2	0.756
SD400-19.20-P	02635995	■	-	19,2	0.756
SD400-19.25-M	02925410	-	■	19,25	0.758
SD400-19.447-M	02826264	-	■	19,45	0.766
SD400-19.447-P	02635997	■	-	19,447	0.766
SD400-19.50-M	02826265	-	■	19,5	0.768
SD400-19.50-P	02635998	■	-	19,5	0.768
SD400-19.70-M	02826266	-	■	19,7	0.776
SD400-19.70-P	02635999	■	-	19,7	0.776
SD400-19.80-M	02826267	-	■	19,8	0.780
SD400-19.80-P	02636000	■	-	19,8	0.780
SD400-19.844-M	02826268	-	■	19,84	0.781
SD400-19.844-P	02636001	■	-	19,844	0.781
SD400-19.90-M	02826269	-	■	19,9	0.783
SD400-19.90-P	02636002	■	-	19,9	0.783

■ Standard magazynowy.

Wstęp

Wiercenie

Rozwiercanie

Wyłaczanie

Załącznik

SMG		f					v _c
		Ø12,00 Ø 0.472	Ø14,00 Ø 0.551	Ø16,00 Ø 0.630	Ø18,00 Ø 0.709	Ø20,00 Ø 0.787	
P1	P	0,30	0,32	0,34	0,36	0,36	155
	P	0.012	0.013	0.013	0.014	0.014	510
P2	P	0,30	0,32	0,34	0,36	0,38	150
	P	0.012	0.013	0.013	0.014	0.015	490
P3	P	0,28	0,30	0,32	0,34	0,36	130
	P	0.011	0.012	0.013	0.013	0.014	425
P4	P	0,28	0,30	0,32	0,34	0,34	115
	P	0.011	0.012	0.013	0.013	0.013	375
P5	P	0,28	0,30	0,32	0,32	0,34	110
	P	0.011	0.012	0.013	0.013	0.013	360
P6	P	0,28	0,30	0,30	0,32	0,34	120
	P	0.011	0.012	0.012	0.013	0.013	395
P7	P	0,28	0,30	0,30	0,32	0,34	115
	P	0.011	0.012	0.012	0.013	0.013	375
P8	P	0,28	0,30	0,32	0,34	0,36	110
	P	0.011	0.012	0.013	0.013	0.014	360
P11	P	0,28	0,30	0,30	0,32	0,34	110
	P	0.011	0.012	0.012	0.013	0.013	360
P12	P	0,19	0,20	0,22	0,22	0,24	65
	P	0.0075	0.0080	0.0085	0.0085	0.0095	215
M1	M	0,17	0,19	0,20	0,22	0,22	95
	M	0.0065	0.0075	0.0080	0.0085	0.0085	310
M2	M	0,16	0,17	0,18	0,19	0,20	80
	M	0.0065	0.0065	0.0070	0.0075	0.0080	260
M3	M	0,13	0,14	0,14	0,15	0,16	60
	M	0.0050	0.0055	0.0055	0.0060	0.0065	195
M4	M	0,11	0,12	0,13	0,13	0,14	45
	M	0.0044	0.0048	0.0050	0.0050	0.0055	150
M5	M	0,11	0,12	0,13	0,13	0,14	37
	M	0.0044	0.0048	0.0050	0.0050	0.0055	120
K1	P	0,28	0,30	0,32	0,34	0,36	110
	P	0.011	0.012	0.013	0.013	0.014	360
K2	P	0,26	0,28	0,30	0,32	0,32	95
	P	0.010	0.011	0.012	0.013	0.013	310
K3	P	0,26	0,28	0,30	0,32	0,32	80
	P	0.010	0.011	0.012	0.013	0.013	260
K4	P	0,26	0,28	0,30	0,32	0,32	75
	P	0.010	0.011	0.012	0.013	0.013	245
K5	P	0,24	0,25	0,26	0,28	0,30	45
	P	0.0095	0.010	0.010	0.011	0.012	150
N2	M	0,26	0,28	0,30	0,32	0,34	215
	M	0.010	0.011	0.012	0.013	0.013	710
N3	M	0,26	0,28	0,30	0,32	0,34	145
	M	0.010	0.011	0.012	0.013	0.013	475
N11	M	0,26	0,28	0,30	0,32	0,34	170
	M	0.010	0.011	0.012	0.013	0.013	560
S1	M	0,095	0,11	0,12	0,13	0,13	34
	M	0.0038	0.0044	0.0048	0.0050	0.0050	110
S2	M	0,095	0,11	0,12	0,13	0,13	24
	M	0.0038	0.0044	0.0048	0.0050	0.0050	80
S3	M	0,095	0,11	0,12	0,13	0,13	24
	M	0.0038	0.0044	0.0048	0.0050	0.0050	80
S11	M	0,16	0,17	0,19	0,20	0,22	65
	M	0.0065	0.0065	0.0075	0.0080	0.0085	215
S12	M	0,16	0,17	0,19	0,20	0,22	49
	M	0.0065	0.0065	0.0075	0.0080	0.0085	160
S13	M	0,14	0,15	0,17	0,18	0,19	38
	M	0.0055	0.0060	0.0065	0.0070	0.0075	125
H3	P	0,12	0,13	0,14	0,15	0,15	32
	P	0.0048	0.0050	0.0055	0.0060	0.0060	105
H5	P	0,19	0,20	0,22	0,22	0,24	60
	P	0.0075	0.0080	0.0085	0.0085	0.0095	195
H7	P	0,12	0,13	0,14	0,15	0,15	32
	P	0.0048	0.0050	0.0055	0.0060	0.0060	105
H8	P	0,14	0,15	0,16	0,17	0,18	60
	P	0.0055	0.0060	0.0065	0.0065	0.0070	195
H11	P	0,19	0,20	0,22	0,22	0,24	75
	P	0.0075	0.0080	0.0085	0.0085	0.0095	245
H12	P	0,14	0,15	0,16	0,17	0,18	39
	P	0.0055	0.0060	0.0065	0.0065	0.0070	130
H21	P	0,14	0,15	0,16	0,17	0,18	60
	P	0.0055	0.0060	0.0065	0.0065	0.0070	195

SMG = Grupy materiałowe Seco f = mm/obr (cal/obr) v_c = m/min (stp/min) Wszystkie parametry są wartościami początkowymi

Wstęp

Wiercenie

Rozwiercanie

Wyłaczanie

Załącznik

SD405 – Ø 12-20 mm / 0.472-0.787 cal

SMG		f					V _c
		Ø 12,00 Ø 0.472	Ø 14,00 Ø 0.551	Ø 16,00 Ø 0.630	Ø 18,00 Ø 0.709	Ø 20,00 Ø 0.787	
P1	P	0,30	0,32	0,34	0,36	0,36	125
	P	0.012	0.013	0.013	0.014	0.014	410
P2	P	0,30	0,32	0,34	0,36	0,38	120
	P	0.012	0.013	0.013	0.014	0.015	395
P3	P	0,28	0,30	0,32	0,34	0,36	105
	P	0.011	0.012	0.013	0.013	0.014	345
P4	P	0,28	0,30	0,32	0,34	0,34	95
	P	0.011	0.012	0.013	0.013	0.013	310
P5	P	0,28	0,30	0,32	0,32	0,34	90
	P	0.011	0.012	0.013	0.013	0.013	295
P6	P	0,28	0,30	0,30	0,32	0,34	100
	P	0.011	0.012	0.012	0.013	0.013	330
P7	P	0,28	0,30	0,30	0,32	0,34	95
	P	0.011	0.012	0.012	0.013	0.013	310
P8	P	0,28	0,30	0,32	0,34	0,36	90
	P	0.011	0.012	0.013	0.013	0.014	295
P11	P	0,28	0,30	0,30	0,32	0,34	90
	P	0.011	0.012	0.012	0.013	0.013	295
P12	P	0,19	0,20	0,22	0,22	0,24	55
	P	0.0075	0.0080	0.0085	0.0085	0.0095	180
M1	M	0,17	0,19	0,20	0,22	0,22	80
	M	0.0065	0.0075	0.0080	0.0085	0.0085	260
M2	M	0,16	0,17	0,18	0,19	0,20	65
	M	0.0065	0.0065	0.0070	0.0075	0.0080	215
M3	M	0,13	0,14	0,14	0,15	0,16	49
	M	0.0050	0.0055	0.0055	0.0060	0.0065	160
M4	M	0,11	0,12	0,13	0,13	0,14	37
	M	0.0044	0.0048	0.0050	0.0050	0.0055	120
M5	M	0,11	0,12	0,13	0,13	0,14	31
	M	0.0044	0.0048	0.0050	0.0050	0.0055	100
K1	P	0,28	0,30	0,32	0,34	0,36	90
	P	0.011	0.012	0.013	0.013	0.014	295
K2	P	0,26	0,28	0,30	0,32	0,32	75
	P	0.010	0.011	0.012	0.013	0.013	245
K3	P	0,26	0,28	0,30	0,32	0,32	65
	P	0.010	0.011	0.012	0.013	0.013	215
K4	P	0,26	0,28	0,30	0,32	0,32	60
	P	0.010	0.011	0.012	0.013	0.013	195
K5	P	0,24	0,25	0,26	0,28	0,30	37
	P	0.0095	0.010	0.010	0.011	0.012	120
N2	M	0,26	0,28	0,30	0,32	0,34	175
	M	0.010	0.011	0.012	0.013	0.013	570
N3	M	0,26	0,28	0,30	0,32	0,34	120
	M	0.010	0.011	0.012	0.013	0.013	395
N11	M	0,26	0,28	0,30	0,32	0,34	140
	M	0.010	0.011	0.012	0.013	0.013	460
S1	M	0,095	0,11	0,12	0,13	0,13	28
	M	0.0038	0.0044	0.0048	0.0050	0.0050	90
S2	M	0,095	0,11	0,12	0,13	0,13	20
	M	0.0038	0.0044	0.0048	0.0050	0.0050	65
S3	M	0,095	0,11	0,12	0,13	0,13	20
	M	0.0038	0.0044	0.0048	0.0050	0.0050	65
S11	M	0,16	0,17	0,19	0,20	0,22	50
	M	0.0065	0.0065	0.0075	0.0080	0.0085	165
S12	M	0,16	0,17	0,19	0,20	0,22	40
	M	0.0065	0.0065	0.0075	0.0080	0.0085	130
S13	M	0,14	0,15	0,17	0,18	0,19	31
	M	0.0055	0.0060	0.0065	0.0070	0.0075	100
H3	P	0,12	0,13	0,14	0,15	0,15	26
	P	0.0048	0.0050	0.0055	0.0060	0.0060	85
H5	P	0,19	0,20	0,22	0,22	0,24	49
	P	0.0075	0.0080	0.0085	0.0085	0.0095	160
H7	P	0,12	0,13	0,14	0,15	0,15	26
	P	0.0048	0.0050	0.0055	0.0060	0.0060	85
H8	P	0,14	0,15	0,16	0,17	0,18	49
	P	0.0055	0.0060	0.0065	0.0065	0.0070	160
H11	P	0,19	0,20	0,22	0,22	0,24	60
	P	0.0075	0.0080	0.0085	0.0085	0.0095	195
H12	P	0,14	0,15	0,16	0,17	0,18	32
	P	0.0055	0.0060	0.0065	0.0065	0.0070	105
H21	P	0,14	0,15	0,16	0,17	0,18	49
	P	0.0055	0.0060	0.0065	0.0065	0.0070	160

SMG = Grupy materiałowe Seco f = mm/obr (cal/obr) v_c = m/min (stp/min) Wszystkie parametry są wartościami początkowymi

SMG		f					v _c
		Ø 12,00 Ø 0.472	Ø 14,00 Ø 0.551	Ø 16,00 Ø 0.630	Ø 18,00 Ø 0.709	Ø 20,00 Ø 0.787	
P1	P	0,30	0,32	0,34	0,36	0,36	100
	P	0.012	0.013	0.013	0.014	0.014	330
P2	P	0,30	0,32	0,34	0,36	0,38	100
	P	0.012	0.013	0.013	0.014	0.015	330
P3	P	0,28	0,30	0,32	0,34	0,36	85
	P	0.011	0.012	0.013	0.013	0.014	280
P4	P	0,28	0,30	0,32	0,34	0,34	75
	P	0.011	0.012	0.013	0.013	0.013	245
P5	P	0,28	0,30	0,32	0,32	0,34	70
	P	0.011	0.012	0.013	0.013	0.013	230
P6	P	0,28	0,30	0,30	0,32	0,34	80
	P	0.011	0.012	0.012	0.013	0.013	260
P7	P	0,28	0,30	0,30	0,32	0,34	75
	P	0.011	0.012	0.012	0.013	0.013	245
P8	P	0,28	0,30	0,32	0,34	0,36	70
	P	0.011	0.012	0.013	0.013	0.014	230
P11	P	0,28	0,30	0,30	0,32	0,34	75
	P	0.011	0.012	0.012	0.013	0.013	245
P12	P	0,19	0,20	0,22	0,22	0,24	43
	P	0.0075	0.0080	0.0085	0.0085	0.0095	140
M1	M	0,17	0,19	0,20	0,22	0,22	65
	M	0.0065	0.0075	0.0080	0.0085	0.0085	215
M2	M	0,16	0,17	0,18	0,19	0,20	50
	M	0.0065	0.0065	0.0070	0.0075	0.0080	165
M3	M	0,13	0,14	0,14	0,15	0,16	39
	M	0.0050	0.0055	0.0055	0.0060	0.0065	130
M4	M	0,11	0,12	0,13	0,13	0,14	29
	M	0.0044	0.0048	0.0050	0.0050	0.0055	95
M5	M	0,11	0,12	0,13	0,13	0,14	24
	M	0.0044	0.0048	0.0050	0.0050	0.0055	80
K1	P	0,28	0,30	0,32	0,34	0,36	70
	P	0.011	0.012	0.013	0.013	0.014	230
K2	P	0,26	0,28	0,30	0,32	0,32	60
	P	0.010	0.011	0.012	0.013	0.013	195
K3	P	0,26	0,28	0,30	0,32	0,32	50
	P	0.010	0.011	0.012	0.013	0.013	165
K4	P	0,26	0,28	0,30	0,32	0,32	49
	P	0.010	0.011	0.012	0.013	0.013	160
K5	P	0,24	0,25	0,26	0,28	0,30	29
	P	0.0095	0.010	0.010	0.011	0.012	95
N2	M	0,26	0,28	0,30	0,32	0,34	140
	M	0.010	0.011	0.012	0.013	0.013	460
N3	M	0,26	0,28	0,30	0,32	0,34	95
	M	0.010	0.011	0.012	0.013	0.013	310
N11	M	0,26	0,28	0,30	0,32	0,34	110
	M	0.010	0.011	0.012	0.013	0.013	360
S1	M	0,095	0,11	0,12	0,13	0,13	22
	M	0.0038	0.0044	0.0048	0.0050	0.0050	70
S2	M	0,095	0,11	0,12	0,13	0,13	16
	M	0.0038	0.0044	0.0048	0.0050	0.0050	50
S3	M	0,095	0,11	0,12	0,13	0,13	16
	M	0.0038	0.0044	0.0048	0.0050	0.0050	50
S11	M	0,16	0,17	0,19	0,20	0,22	42
	M	0.0065	0.0065	0.0075	0.0080	0.0085	140
S12	M	0,16	0,17	0,19	0,20	0,22	32
	M	0.0065	0.0065	0.0075	0.0080	0.0085	105
S13	M	0,14	0,15	0,17	0,18	0,19	25
	M	0.0055	0.0060	0.0065	0.0070	0.0075	80
H3	P	0,12	0,13	0,14	0,15	0,15	21
	P	0.0048	0.0050	0.0055	0.0060	0.0060	70
H5	P	0,19	0,20	0,22	0,22	0,24	39
	P	0.0075	0.0080	0.0085	0.0085	0.0095	130
H7	P	0,12	0,13	0,14	0,15	0,15	21
	P	0.0048	0.0050	0.0055	0.0060	0.0060	70
H8	P	0,14	0,15	0,16	0,17	0,18	39
	P	0.0055	0.0060	0.0065	0.0065	0.0070	130
H11	P	0,19	0,20	0,22	0,22	0,24	49
	P	0.0075	0.0080	0.0085	0.0085	0.0095	160
H12	P	0,14	0,15	0,16	0,17	0,18	26
	P	0.0055	0.0060	0.0065	0.0065	0.0070	85
H21	P	0,14	0,15	0,16	0,17	0,18	39
	P	0.0055	0.0060	0.0065	0.0065	0.0070	130

SMG = Grupy materiałowe Seco f = mm/obr (cal/obr) v_c = m/min (stp/min) Wszystkie parametry są wartościami początkowymi

Wstęp

Wiercenie

Rozwiercanie

Wyłaczanie

Załącznik

Informacje odnośnie zastosowania

Informacje odnośnie zastosowania

Obrobiona powierzchnia

Brak potrzeby nawiercania lub redukcji posuwu na wejściu gdy stosujemy SD403 i SD405. Gdy stosujemy wiertło SD408 wiercenie wstępne jest zawsze zalecane. (Gdy stosujemy SD405 w stali nierdzewnej może być wymagane wiercenie wstępne).

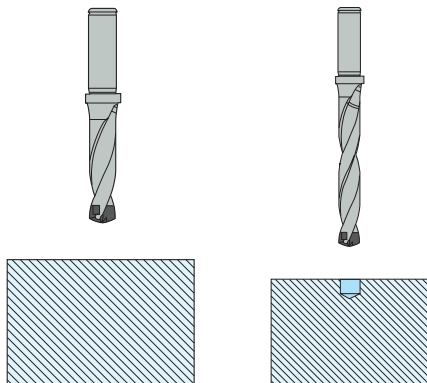

Pakiety materiałowe

Istnieje możliwość wiercenia pakietów zamocowanych w bezpieczny sposób, tak aby nie powstawały szczeliny między warstwami materiału. W szczeliny mogą wnikać wióry, w konsekwencji powodując zniszczenie wiertła.

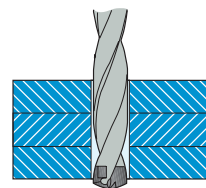

Nieregularne/Kątowe wejście w materiał

Jeśli wejście w mat. jest nieregularne lub pod kątem, należy wykonać operację wstępną. Gdy stosujemy wiertła $> 3 \times D$ zalecane jest wstępne wiercenie wiertłem np. SD403

Alternatywy wiercenia wstępnego

Wykonanie pogłębienia frezem walcowo-czołowym.

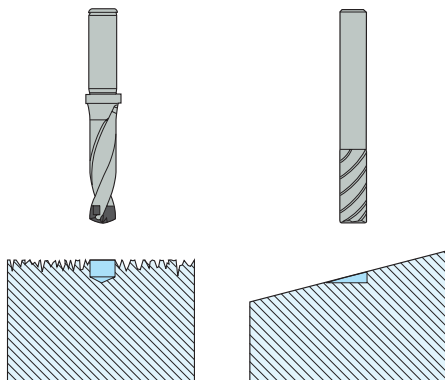

Nireg. wejście w materiał

Kątowe wej. w materiał

Zalecenia dotyczące chłodzenia

Ciśnienie chłodziwa

Minimalne zalecane ciśnienie chłodziwa wynosi 10 bar (145 PSI) przy $\leq 3 \times D$
Minimalne zalecane ciśnienie chłodziwa wynosi 30 bar (435 PSI) przy $> 3 \times D$

Koncentracja emulsji

Zalecane koncentracja emulsji 6-8%. Przy wierceniu w stali nierdz., superstopach i stali o dużej wytrzymał. zaleca się stężenie emulsji 10%

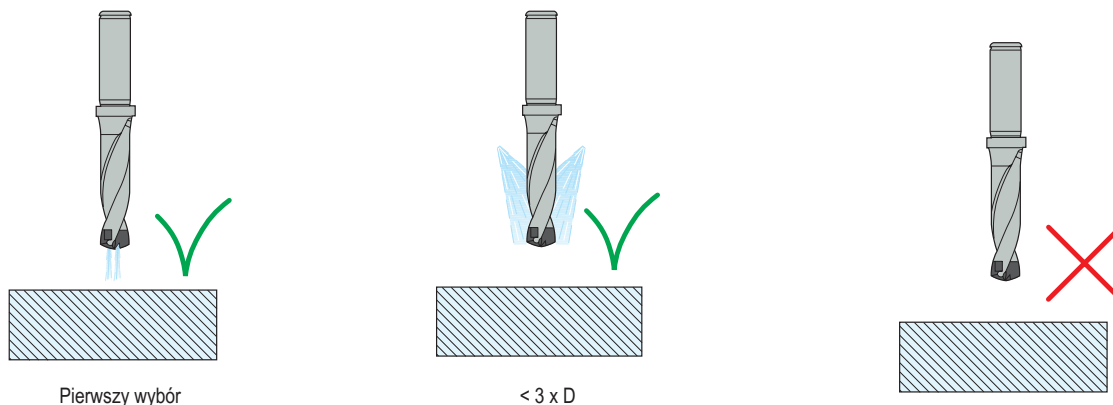

Pierwszy wybór

$< 3 \times D$

Parametry skrawania

Wartości z wykresów mogą ulegać zmianie, zależnie od parametrów, materiału, wydajności obrabiarki i zużycia narzędzia.
Poniższe wykresy obowiązują dla grupy materiału P5-P6 i prędkości skrawania 90 m/min (295 sf/min).

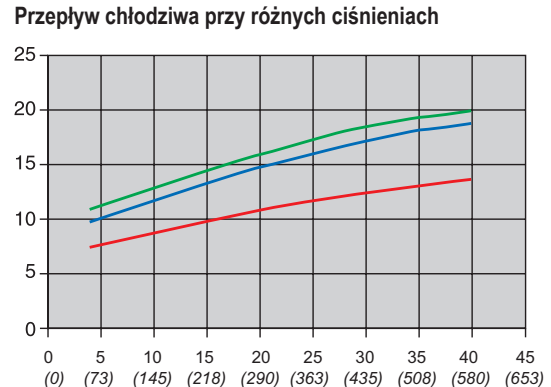
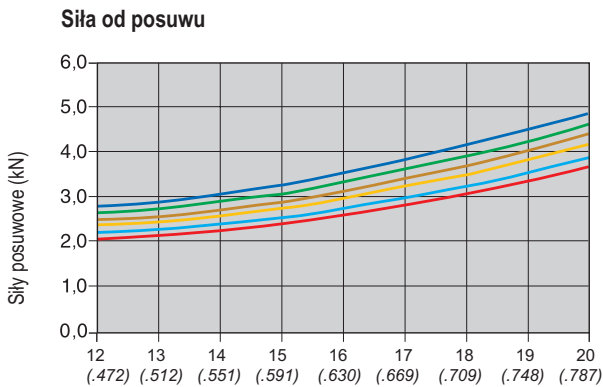
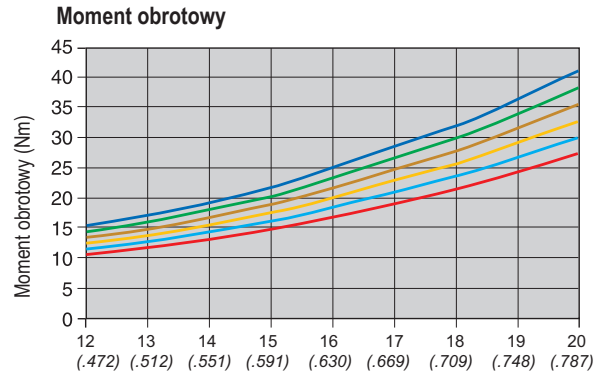
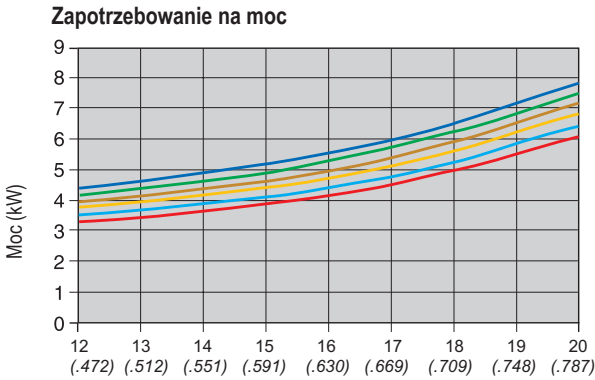

Zalecany przepływ chłodziwa $D \times 1$ l/min.
Minimalny przepływ chłodziwa $D/2$ l/min.
D = średnica wiertła
Minimalne zalecane ciśnienie chłodziwa 10 bar (145 PSI) przy $\leq 3 \times D$
Minimalne zalecane ciśnienie chłodziwa 20 bar (290 PSI) przy $\leq 5 \times D$
Minimalne zalecane ciśnienie chłodziwa 40 bar (580 PSI) przy $> 5 \times D$

Koncentracja emulsji
Zalecane koncentracja emulsji 6-8%.
Przy wierceniu w stali nierdz., superstopach i stali o dużej wytrzymałości zaleca się stężenie emulsji 10%.

Tolerancja otworu/Gładkość powierzchni

SD403, SD405 i SD408 IT9-10 / R_a 1-4*, R_a 39-157 μm *					
Wiertło Ø DC (mm)	Tolerancja IT9 (μm)	Tolerancja IT10 (μm)	Wiertło Ø DC (cale)	Tolerancja IT9 (cale)	Tolerancja IT10 (cale)
10-18	0 - +43	0 - +70	0 - +0.394-0.709	0 - +0.0017	0 - +0.0028
18-30	0 - +52	0 - +84	0 - +0.709-1.181	0 - +0.0020	0 - +0.0033

*W przypadku wiercenia w stali niskowęglowej lub nierdzewnej może wystąpić pogorszenie chropowatości. Stosować możliwie najkrótsze wiertło w celu uzyskania otworu o najlepszej jakości.

Rozwiązywanie problemów - Co powinniśmy sprawdzić w pierwszej kolejności:

- Stabilność mocowania
- Stan techniczny wrzeciona
- Stan techniczny oprawki
- Zamocowanie narzędzia:
 - Bicie w granicach 0,06 (różnica skrajnych wskazań czujnika)
- Usuwanie wiórów:
 - Parametry skrawania
- Chłodzenie:
 - Ciśnienie
 - Wydatek
 - Koncentracja

<p>Wykruszanie się krawędzi skrawających</p> <ul style="list-style-type: none"> • Zredukować posuw /obr. • Jeśli wiertło drga, zredukować prędkość skrawania i zwiększyć posuw. • Podczas wiercenia w surowej, twardej lub nachylonej powierzchni, zredukować posuw o 30%-50% na wejściu i wyjściu. 	<p>Zła tolerancja średnicy.</p> <ul style="list-style-type: none"> • Zwiększ posuw/obr. • Zastosuj wiertło węglikowe Seco Feedmax, patrz str. 15-18 • Zastosuj operację rozwiercania, patrz str. 322 • Zastosuj operację wytaczania, patrz str. 492-493
<p>Zbyt szybkie zużycie się powierzchni przyłożenia</p> <ul style="list-style-type: none"> • Sprawdź czy użyto właściwej geometrii • Zredukować prędkość skrawania 	<p>Zła gładkość powierzchni</p> <ul style="list-style-type: none"> • Zredukuj posuw/obr. • Zwiększ prędkość skrawania • Sprawdź czy zastosowano prawidłową geometrię • Zastosuj wiertło węglikowe Seco Feedmax, patrz str. 15-18 • Zastosuj operację rozwiercania, patrz str. 322
<p>Zużycie się rowka</p> <ul style="list-style-type: none"> • Zredukować posuw/obr. • Zredukować prędkość skrawania. • Zwiększyć koncentrację chłodziwa. 	<p>Złe położenie otworu</p> <ul style="list-style-type: none"> • Zredukuj posuw/obr. • Podczas wiercenia w surowej, twardej lub nachylonej powierzchni, zredukować posuw o 30%-50% na wejściu i wyjściu • Nawiercić wstępnie wiertłem o kącie 140°. • Zastosuj wiertło węglikowe Seco Feedmax, patrz str. 15-18 • Zastosuj operację wytaczania, patrz str. 492-493
<p>Zużycie zewnętrznej tyśinki.</p> <ul style="list-style-type: none"> • Sprawdź czy użyto właściwej geometrii. • Zredukuj prędkość skrawania. • Zwiększ koncentrację chłodziwa. • Podczas wiercenia w surowej, twardej lub nachylonej powierzchni, zredukuj posuw o 30%-50% na wejściu i wyjściu. 	<p>Zakleszczanie długich wiórów</p> <ul style="list-style-type: none"> • Zwiększyć posuw • Przy materiałach dających długi wiór, grupy mat. P1-P4, M1-M2: <ul style="list-style-type: none"> – Zwiększyć prędkość skrawania i zredukować posuw/obr. – Zastosować geometrię -L



Perfomax®

Perfomax® to dostępna od dawna na rynku, sprawdzona gama wiertel na płytki wymienne, ekonomiczne rozwiązanie pozwalające na wydajne wiercenie otworów.

- Niezawodne i godne zaufania kwadratowe płytki, wyposażone w cztery krawędzie skrawające.
- Większość nowoczesnych gatunków węgla i geometrii do różnych materiałów obrabianych
- Korpus wiertła ma unikatową konstrukcję rowków wiórowych i otwory do chłodziwa we wszystkich wielościach, co zapewnia optymalizację usuwania wiórów.

Przegląd asortymentu

Perfomax®	Zakres \varnothing	Głębokość wiercenia	Tolerancja \varnothing otworu	Tolerancja otworu
<p>SD522</p>  <p>Str. - 230, 231, 232, 233-237, 238, 239</p>	15-59 mm (0.594-2.375")	~ 2 x D	+/- 0,1 mm (+/- 0.004")	+0/+ 0,2 mm (+0/+ 0.008")
<p>SD523</p>  <p>Str. - 240, 241, 242, 243-256, 257, 258</p>	15-59 mm (0.594-2.375")	~ 3 x D	+/- 0,1 mm (+/- 0.004")	+0/+ 0,3 mm (+0/+ 0.012")
<p>SD524</p>  <p>Str. - 259, 260, 261-271, 272</p>	17-59 mm (0.594-2.375")	~ 4 x D	+/- 0,1 mm (+/- 0.004")	+ 0,4 mm (+0/+ 0.016")
<p>SD525</p>  <p>Str. - 273, 274-275</p>	19-45 mm (0.750-2.000")	~ 5 x D	+/- 0,1 mm (+/- 0.004")	+0/+ 0,5 mm (+0/+ 0.020")
<p>SD542</p>  <p>Str. - 276-277</p>	60-85 mm (2.250-3.500")	~ 2.5 x D	+/- 0,1 mm (+/- 0.004")	+0/+ 0,2 mm (+0/+ 0.008")

Przeгляд asortymentu

Perfomax®	Zakres \varnothing	Głębokość wiercenia	Tolerancja \varnothing otworu	Tolerancja otworu
SD572  Str. - 278, 279	15-47 mm (0.591"-1.850")	~ 2 x D	+/- 0,1 mm (+/- 0.004")	+0/+ 0,2 mm (+0/+ 0.008")
SD602  Str. - 282-286	60-160 mm (2.5"-4.000")	~ 1-10 x D	+/- 0,2 mm (+/- 0.008")	-

Wstęp

Wiercenie

Rozwiercanie

Wytaczanie

Załącznik

Oznaczenie wiertła z płytką wymienną

Metryczne

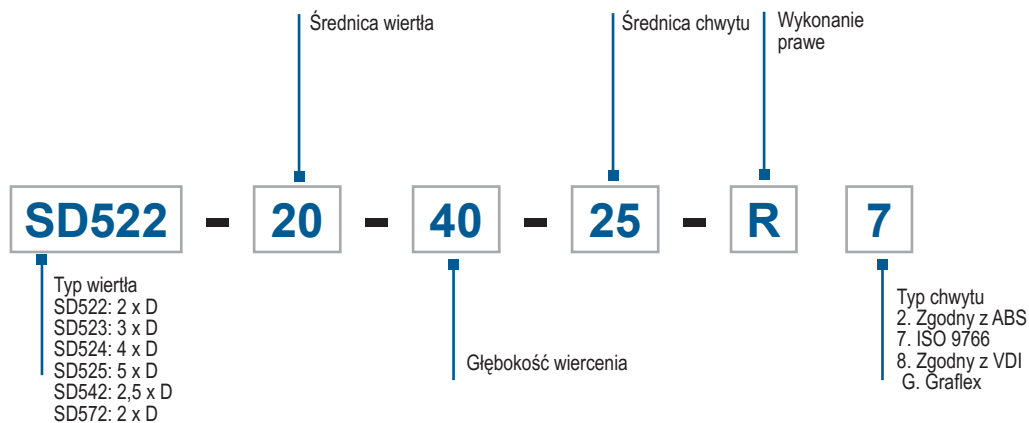

Calowe

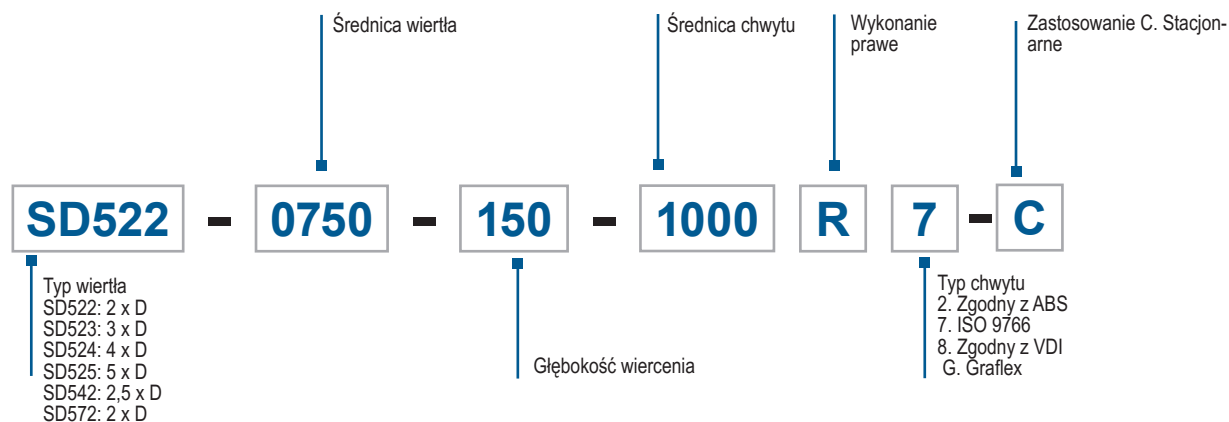

Capto™

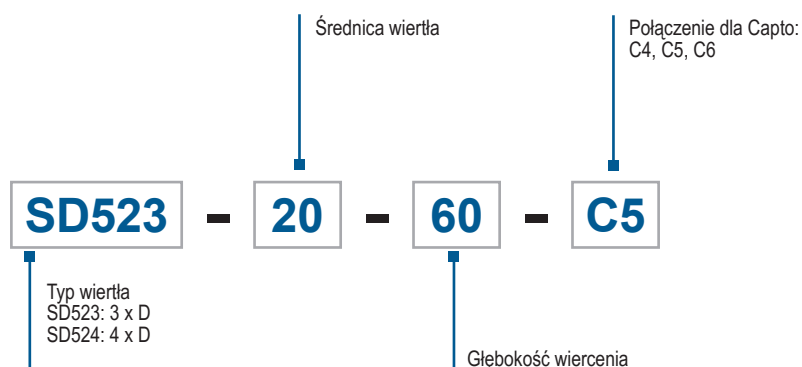

Chwyty

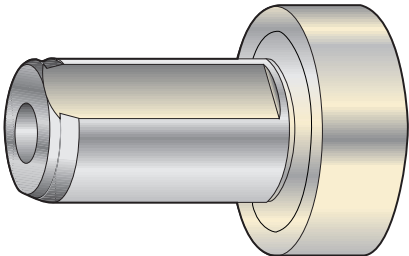
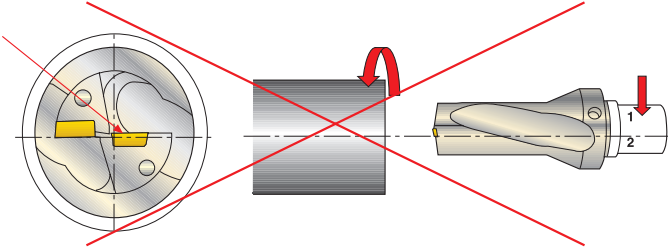
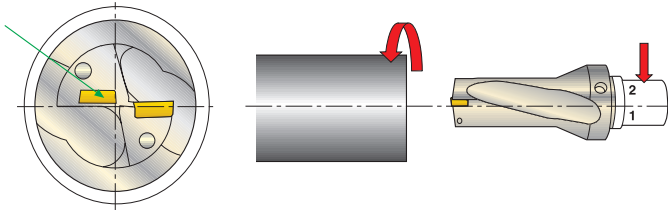
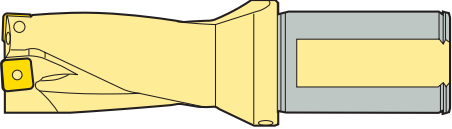
Chwyty	
<p>-R7</p> 	<p>ISO 9766 Wybór podstawowy dla większości opravek obecnych na rynku, takich jak:</p> <ul style="list-style-type: none"> • Weldon 1835B • ISO 5414 • DIN 69880 <p>Doprowadzenie chłodziwa do chwytu wiertła.</p>
<p>R7 i R7-C</p> 	<p>Chwyty z dwoma lub czterema spłaszczeniami Krawędź skrawająca płytki środkowej nad linią środkową elementu obrabianego.</p> <p>Do zastosowań nieobrotowych:</p> <ul style="list-style-type: none"> • Dodatkowe spłaszczenie na chwycie jest w celu poprawy elastyczności przy operacjach tokarskich. • W takich zastosowaniach niezbędnej jest utrzymanie współosiowości wiertła i detalu. • W przypadku niezachowania tego warunku płytka centralna może przesunąć się nad oś detalu. Spowoduje to zmniejszenie trwałości ostrza.
 <p>Obrót wiertła o 180 stopni i wykorzystanie drugiego spłaszczenia daje, w sposób łatwy i szybki, możliwość kompensacji przestawienia osiowego wiertła.</p>	<p>Chwyty z czterema spłaszczeniami Krawędź skrawająca płytki środkowej nad linią środkową elementu obrabianego.</p>
	<p>UWAGA!</p> <ul style="list-style-type: none"> • W przypadku użycia wiertła z chwytem -7 w zastosowaniach obrotowych z oprawką regulowaną lub bez, należy użyć spłaszczenia położonego po tej samej stronie co płytka centralna. • W przeciwnym wypadku wiertło zamocowane będzie nieprawidłowo.

Chwyty

Seco-Capto

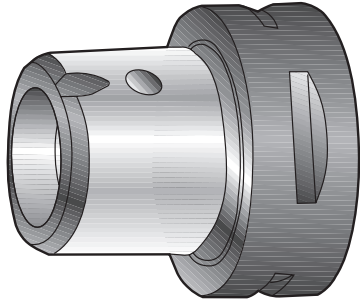

Seco-Capto™: C4, C5, C6

- Elastyczność- Ta sama oprawka może być użyta na różnych obrabiarkach.
- Modułowość — możliwość budowania narzędzi z wykorzystaniem adapterów przedłużających.
- Przenoszenie dużych momentów - Obciążenie jest rozłożone symetrycznie.
- Duża sztywność - Duża dokładność i siła połączenia gwarantują sztywność.
- Dokładność - Specjalny wielokątny stożek zapewnia mocne, samocentrujące połączenie z dokładnością do 2 mikronów.

Graflex

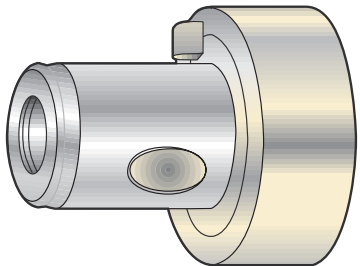

-G

- Pasuje bezpośrednio do opravek Graflex i jest mocowany dwiema śrubami kulowymi rozstawionymi o 120°.
- Modułowe zespoły zapewniające sztywność i dobre parametry bicia.
- Połączenie powierzchni cylindrycznej i płaskiej — wysoka dokładność.
- Szybki i łatwy montaż/demontaż modułów zapewnia dużą uniwersalność.
- Doprowadzenie chłodziwa do chwytu wiertła.

ABS 50 (zgodny)

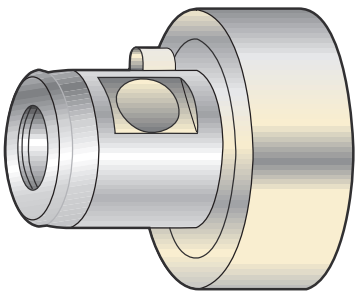

- 2

- Chwyt zgodny z ABS 50.
- Pasuje bezpośrednio do opravek ABS 50 z jedną śrubą zabezpieczającą.
- Doprowadzenie chłodziwa do chwytu wiertła.

VDI 30 i VDI 40 (zgodne)

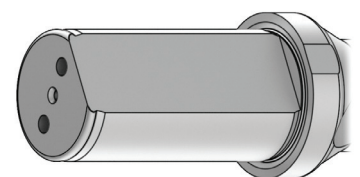





- 8

- Chwyt zgodny z VDI.
- Pasuje bezpośrednio do opravek:
 - VDI 3425 bl.2
 - DIN 69880

UWAGA!

Pierścień do chłodziwa należy zamawiać oddzielnie

Chwyty — pierścien chłodziwa

VDI 30				VDI 40					
Głębokość wiercenia	Średnica wiertła		Akcesoria Pierścień	Głębokość wiercenia	Średnica wiertła		Zaślepka	Śruba mocująca	Akcesoria Pierścień
	mm	cale			mm	cale			
									
2 x D	15-31	0.591-1.220	SDA5-30R8	2 x D	15-31	0.591-1.220			SDA5-40R8
3 x D	15-31	0.591-1.220	SDA5-30R8	3 x D	15-31	0.591-1.220			SDA5-40R8
4 x D	17-31	0.669-1.220	SDA5-30R8	4 x D	17-31	0.669-1.220			SDA5-40R8
5 x D	19-31	0.748-1.220	SDA5-30R8	5 x D	19-31	0.748-1.220			SDA5-40R8
				2 x D	41-59	1.614-2.323	R1/4"	P6SS8x8	SDA5-40R8
				3 x D	41-59	1.614-2.323	R1/4"	P6SS8x8	SDA5-40R8

1. Należy umieścić pierścień na wiertle bez dociągania śrub mocujących

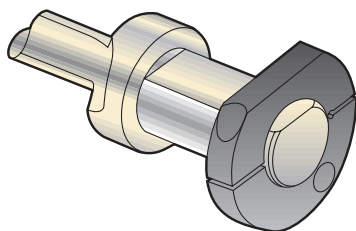

2. Zamocować wiertło w tulejce

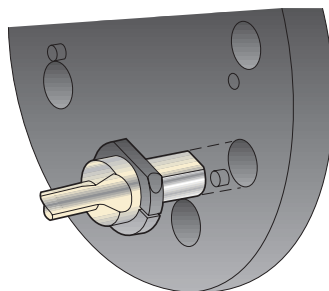

3. Dociągnąć śruby mocujące pierścienia do chłodzenia

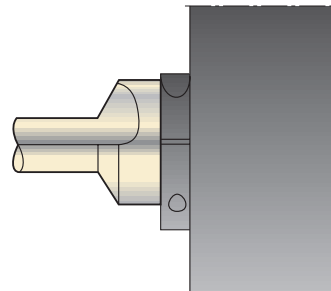

Pierścien do chłodzenia

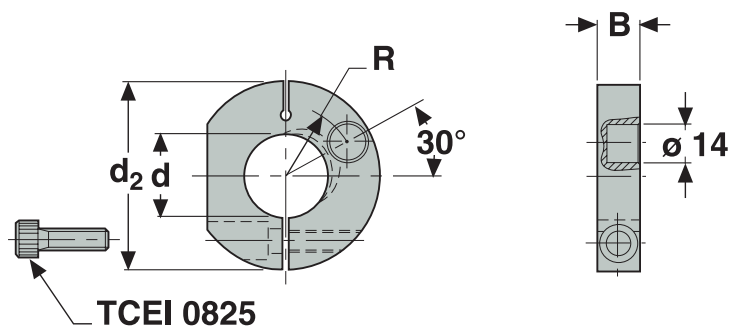

SD522

Głębokość wiercenia ~ 2 x D – Metryczne/Calowe

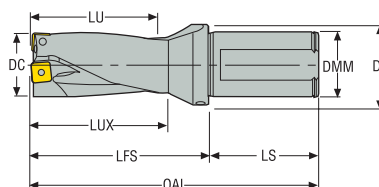

- Chwyt ISO 9766, -7
- Chłodzenie wewnętrzne
- Informacja na temat płytek patrz str. 292-298
- Parametry skrawania, patrz strona (strony) 299, 300
- Średnice pośrednie patrz aplikacja MyDesign.

Oznaczenie	Numer produktu	DC	LU	OAL	LUX	LFS	LS	DMM	DF	Płytki		Regulacja promieniowa	
										Płytki centralna	Płytki peryferyjna	mm - Cal. -	mm + Cal. +
SD522-15-30-20R7	03080744	15,0 0.591	30,0 1.181	110,0 4.331	35,0 1.378	60,0 2.362	50,0 1.969	20,0 0.787	30,0 1.181	SPGX0502	SCGX050204	0,22 0.009	0,31 0.012
SD522-15-30-25R7	03080745	15,0 0.591	30,0 1.181	116,0 4.567	35,0 1.378	60,0 2.362	56,0 2.205	25,0 0.984	35,0 1.378	SPGX0502	SCGX050204	0,22 0.009	0,31 0.012
SD522-15.5-31-20R7	03080740	15,5 0.610	31,0 1.220	111,0 4.370	36,0 1.417	61,0 2.402	50,0 1.969	20,0 0.787	30,0 1.181	SPGX0502	SCGX050204	0,17 0.007	0,36 0.014
SD522-15.5-31-25R7	03080741	15,5 0.610	31,0 1.220	117,0 4.606	36,0 1.417	61,0 2.402	56,0 2.205	25,0 0.984	35,0 1.378	SPGX0502	SCGX050204	0,17 0.007	0,36 0.014
SD522-16-32-20R7	03080749	16,0 0.630	32,0 1.260	112,0 4.409	37,0 1.457	62,0 2.441	50,0 1.969	20,0 0.787	30,0 1.181	SPGX0502	SCGX050204	0,12 0.005	0,41 0.016
SD522-16-32-25R7	03080750	16,0 0.630	32,0 1.260	118,0 4.646	37,0 1.457	62,0 2.441	56,0 2.205	25,0 0.984	35,0 1.378	SPGX0502	SCGX050204	0,12 0.005	0,41 0.016
SD522-16.5-33-20R7	03080746	16,5 0.650	33,0 1.299	113,0 4.449	38,0 1.496	63,0 2.480	50,0 1.969	20,0 0.787	30,0 1.181	SPGX0502	SCGX050204	0,07 0.003	0,46 0.018
SD522-16.5-33-25R7	03080747	16,5 0.650	33,0 1.299	119,0 4.685	38,0 1.496	63,0 2.480	56,0 2.205	25,0 0.984	35,0 1.378	SPGX0502	SCGX050204	0,07 0.003	0,46 0.018
SD522-17-34-20R7	03080754	17,0 0.669	34,0 1.339	114,0 4.488	39,0 1.535	64,0 2.520	50,0 1.969	20,0 0.787	30,0 1.181	SPGX0502	SCGX050204	0,02 0.001	0,5 0.020
SD522-17-34-25R7	03080755	17,0 0.669	34,0 1.339	120,0 4.724	39,0 1.535	64,0 2.520	56,0 2.205	25,0 0.984	35,0 1.378	SPGX0502	SCGX050204	0,02 0.001	0,5 0.020
SD522-17.5-35-20R7	03080752	17,5 0.689	35,0 1.378	115,0 4.528	40,0 1.575	65,0 2.559	50,0 1.969	20,0 0.787	30,0 1.181	SPGX0602	SCGX050204	0,43 0.017	0,1 0.004
SD522-17.5-35-25R7	03080753	17,5 0.689	35,0 1.378	121,0 4.764	40,0 1.575	65,0 2.559	56,0 2.205	25,0 0.984	35,0 1.378	SPGX0602	SCGX050204	0,43 0.017	0,1 0.004
SD522-18-36-20R7	03080760	18,0 0.709	36,0 1.417	116,0 4.567	41,0 1.614	66,0 2.598	50,0 1.969	20,0 0.787	30,0 1.181	SPGX0602	SCGX050204	0,32 0.013	0,21 0.008
SD522-18-36-25R7	03080761	18,0 0.709	36,0 1.417	122,0 4.803	41,0 1.614	66,0 2.598	56,0 2.205	25,0 0.984	35,0 1.378	SPGX0602	SCGX050204	0,32 0.013	0,21 0.008
SD522-18.5-37-20R7	03080758	18,5 0.728	37,0 1.457	117,0 4.606	42,0 1.654	67,0 2.638	50,0 1.969	20,0 0.787	30,0 1.181	SPGX0602	SCGX050204	0,22 0.009	0,31 0.012
SD522-18.5-37-25R7	03080759	18,5 0.728	37,0 1.457	123,0 4.843	42,0 1.654	67,0 2.638	56,0 2.205	25,0 0.984	35,0 1.378	SPGX0602	SCGX050204	0,22 0.009	0,31 0.012
SD522-19-38-20R7	03080765	19,0 0.748	38,0 1.496	118,0 4.646	43,0 1.693	68,0 2.677	50,0 1.969	20,0 0.787	30,0 1.181	SPGX0602	SCGX050204	0,11 0.004	0,42 0.017
SD522-19-38-25R7	03080766	19,0 0.748	38,0 1.496	124,0 4.882	43,0 1.693	68,0 2.677	56,0 2.205	25,0 0.984	35,0 1.378	SPGX0602	SCGX050204	0,11 0.004	0,42 0.017
SD522-19.5-39-20R7	03080764	19,5 0.768	39,0 1.535	119,0 4.685	44,0 1.732	69,0 2.717	50,0 1.969	20,0 0.787	30,0 1.181	SPGX0602	SCGX060204	0,11 0.004	0,42 0.017
SD522-20-40-25R7	03080771	20,0 0.787	40,0 1.575	126,0 4.961	45,0 1.772	70,0 2.756	56,0 2.205	25,0 0.984	35,0 1.378	SPGX0602	SCGX060204	0,07 0.003	0,46 0.018
SD522-21-42-25R7	03080775	21,0 0.827	42,0 1.654	128,0 5.039	47,0 1.850	72,0 2.835	56,0 2.205	25,0 0.984	35,0 1.378	SPGX0602	SCGX060204	0,01 0	0,5 0.020
SD522-22-44-25R7	03080777	22,0 0.866	44,0 1.732	130,0 5.118	49,0 1.929	74,0 2.913	56,0 2.205	25,0 0.984	35,0 1.378	SPGX0703	SCGX060204	0,44 0.017	0,46 0.018

Wstęp

Wiercenie

Rozwiercanie

Wyłaczanie

Załącznik

Oznaczenie	Numer produktu	DC	LU	OAL	LUX	LFS	LS	DMM	DF	Płytki		Regulacja promieniowa	
		mm Cal.	mm Cal.	mm Cal.	mm Cal.	mm Cal.	mm Cal.	mm Cal.	mm Cal.	Płytki centralna	Płytki peryferyjna	mm - Cal. -	mm + Cal. +
SD522-23-46-25R7	03080781	23,0 0.906	46,0 1.811	132,0 5.197	51,0 2.008	76,0 2.992	56,0 2.205	25,0 0.984	35,0 1.378	SPGX0703	SCGX070308	0,33 0.013	0,5 0.020
SD522-23.5-47-25R7	03192517	23,5 0.925	47,0 1.850	133,0 5.236	52,0 2.047	77,0 3.031	56,0 2.205	25,0 0.984	35,0 1.378	SPGX0703	SCGX070308	0,23 0.009	0,5 0.020
SD522-24-48-25R7	03080785	24,0 0.945	48,0 1.890	134,0 5.276	53,0 2.087	78,0 3.071	56,0 2.205	25,0 0.984	35,0 1.378	SPGX0703	SCGX070308	0,11 0.004	0,5 0.020
SD522-25-50-32R7	03080788	25,0 0.984	50,0 1.969	140,0 5.512	55,0 2.165	80,0 3.150	60,0 2.362	32,0 1.260	42,0 1.654	SPGX0703	SCGX070308	0,11 0.004	0,5 0.020
SD522-26-52-32R7	03080790	26,0 1.024	52,0 2.047	142,0 5.591	57,0 2.244	82,0 3.228	60,0 2.362	32,0 1.260	42,0 1.654	SPGX0903	SCGX070308	0,5 0.020	0,11 0.004
SD522-27-54-32R7	03080792	27,0 1.063	54,0 2.126	144,0 5.669	59,0 2.323	84,0 3.307	60,0 2.362	32,0 1.260	42,0 1.654	SPGX0903	SCGX070308	0,5 0.020	0,26 0.010
SD522-28-56-32R7	03080795	28,0 1.102	56,0 2.205	146,0 5.748	61,0 2.402	86,0 3.386	60,0 2.362	32,0 1.260	42,0 1.654	SPGX0903	SCGX070308	0,28 0.011	0,5 0.020
SD522-29-58-32R7	03080796	29,0 1.142	58,0 2.283	148,0 5.827	63,0 2.480	88,0 3.465	60,0 2.362	32,0 1.260	42,0 1.654	SPGX0903	SCGX09T308	0,18 0.007	0,5 0.020
SD522-30-60-32R7	03080798	30,0 1.181	60,0 2.362	150,0 5.906	65,0 2.559	90,0 3.543	60,0 2.362	32,0 1.260	42,0 1.654	SPGX0903	SCGX09T308	0,12 0.005	0,5 0.020
SD522-31-62-32R7	03080801	31,0 1.220	62,0 2.441	152,0 5.984	67,0 2.638	92,0 3.622	60,0 2.362	32,0 1.260	42,0 1.654	SPGX0903	SCGX09T308	0,12 0.005	0,5 0.020
SD522-32-64-32R7	03080802	32,0 1.260	64,0 2.520	154,0 6.063	69,0 2.717	94,0 3.701	60,0 2.362	32,0 1.260	42,0 1.654	SPGX11T3	SCGX09T308	0,5 0.020	0,31 0.012
SD522-32-64-40R7	03080803	32,0 1.260	64,0 2.520	162,0 6.378	69,0 2.717	94,0 3.701	68,0 2.677	40,0 1.575	50,0 1.969	SPGX11T3	SCGX09T308	0,5 0.020	0,31 0.012
SD522-33-66-32R7	03080805	33,0 1.299	66,0 2.598	156,0 6.142	71,0 2.795	96,0 3.780	60,0 2.362	32,0 1.260	42,0 1.654	SPGX11T3	SCGX09T308	0,5 0.020	0,46 0.018
SD522-33-66-40R7	03080806	33,0 1.299	66,0 2.598	164,0 6.457	71,0 2.795	96,0 3.780	68,0 2.677	40,0 1.575	50,0 1.969	SPGX11T3	SCGX09T308	0,5 0.020	0,46 0.018
SD522-34-68-32R7	03080808	34,0 1.339	68,0 2.677	158,0 6.220	73,0 2.874	98,0 3.858	60,0 2.362	32,0 1.260	42,0 1.654	SPGX11T3	SCGX09T308	0,22 0.009	0,5 0.020
SD522-34-68-40R7	03080809	34,0 1.339	68,0 2.677	166,0 6.535	73,0 2.874	98,0 3.858	68,0 2.677	40,0 1.575	50,0 1.969	SPGX11T3	SCGX09T308	0,22 0.009	0,5 0.020
SD522-35-70-32R7	03080810	35,0 1.378	70,0 2.756	160,0 6.299	75,0 2.953	100,0 3.937	60,0 2.362	32,0 1.260	42,0 1.654	SPGX11T3	SCGX11T308	0,22 0.009	0,5 0.020
SD522-35-70-40R7	03080811	35,0 1.378	70,0 2.756	168,0 6.614	75,0 2.953	100,0 3.937	68,0 2.677	40,0 1.575	50,0 1.969	SPGX11T3	SCGX11T308	0,22 0.009	0,5 0.020
SD522-36-72-32R7	03080813	36,0 1.417	72,0 2.835	162,0 6.378	77,0 3.031	102,0 4.016	60,0 2.362	32,0 1.260	42,0 1.654	SPGX11T3	SCGX11T308	0,09 0.004	0,5 0.020
SD522-36-72-40R7	03080814	36,0 1.417	72,0 2.835	170,0 6.693	77,0 3.031	102,0 4.016	68,0 2.677	40,0 1.575	50,0 1.969	SPGX11T3	SCGX11T308	0,09 0.004	0,5 0.020
SD522-37-74-32R7	03080816	37,0 1.457	74,0 2.913	164,0 6.457	79,0 3.110	104,0 4.094	60,0 2.362	32,0 1.260	42,0 1.654	SPGX11T3	SCGX11T308	0,09 0.004	0,5 0.020
SD522-37-74-40R7	03080817	37,0 1.457	74,0 2.913	172,0 6.772	79,0 3.110	104,0 4.094	68,0 2.677	40,0 1.575	50,0 1.969	SPGX11T3	SCGX11T308	0,09 0.004	0,5 0.020
SD522-38-76-32R7	03080818	38,0 1.496	76,0 2.992	166,0 6.535	81,0 3.189	106,0 4.173	60,0 2.362	32,0 1.260	42,0 1.654	SPGX12T3	SCGX11T308	0,5 0.020	0,5 0.020
SD522-38-76-40R7	03080819	38,0 1.496	76,0 2.992	174,0 6.850	81,0 3.189	106,0 4.173	68,0 2.677	40,0 1.575	50,0 1.969	SPGX12T3	SCGX11T308	0,5 0.020	0,5 0.020
SD522-39-78-32R7	03080821	39,0 1.535	78,0 3.071	168,0 6.614	83,0 3.268	108,0 4.252	60,0 2.362	32,0 1.260	42,0 1.654	SPGX12T3	SCGX11T308	0,39 0.015	0,5 0.020
SD522-39-78-40R7	03080822	39,0 1.535	78,0 3.071	176,0 6.929	83,0 3.268	108,0 4.252	68,0 2.677	40,0 1.575	50,0 1.969	SPGX12T3	SCGX11T308	0,39 0.015	0,5 0.020
SD522-40-80-32R7	03080823	40,0 1.575	80,0 3.150	170,0 6.693	85,0 3.346	110,0 4.331	60,0 2.362	32,0 1.260	50,0 1.969	SPGX12T3	SCGX11T308	0,19 0.007	0,5 0.020
SD522-40-80-40R7	03080824	40,0 1.575	80,0 3.150	178,0 7.008	85,0 3.346	110,0 4.331	68,0 2.677	40,0 1.575	50,0 1.969	SPGX12T3	SCGX11T308	0,19 0.007	0,5 0.020
SD522-41-82-40R7	03080826	41,0 1.614	82,0 3.228	180,0 7.087	87,0 3.425	112,0 4.409	68,0 2.677	40,0 1.575	50,0 1.969	SPGX12T3	SCGX120408	0,19 0.007	0,5 0.020
SD522-42-84-40R7	03080828	42,0 1.654	84,0 3.307	182,0 7.165	89,0 3.504	114,0 4.488	68,0 2.677	40,0 1.575	50,0 1.969	SPGX12T3	SCGX120408	0,19 0.007	0,5 0.020
SD522-43-86-40R7	03080830	43,0 1.693	86,0 3.386	184,0 7.244	91,0 3.583	116,0 4.567	68,0 2.677	40,0 1.575	50,0 1.969	SPGX12T3	SCGX120408	0,05 0.002	0,5 0.020

Wstęp

Wiercenie

Rozwiercanie

Wylaczanie



Załącznik

Oznaczenie	Numer produktu	DC	LU	OAL	LUX	LFS	LS	DMM	DF	Płytki		Regulacja promieniowa	
		mm Cal.	mm Cal.	mm Cal.	mm Cal.	mm Cal.	mm Cal.	mm Cal.	mm Cal.	mm Cal.	Płytki centralna	Płytki peryferyjna	mm - Cal. -
SD522-44-88-40R7	03080832	44,0 1.732	88,0 3.465	186,0 7.323	93,0 3.661	118,0 4.646	68,0 2.677	40,0 1.575	50,0 1.969	SPGX1504	SCGX120408	0,5 0.020	0,41 0.016
SD522-45-90-40R7	03080834	45,0 1.772	90,0 3.543	188,0 7.402	95,0 3.740	120,0 4.724	68,0 2.677	40,0 1.575	50,0 1.969	SPGX1504	SCGX150512	0,5 0.020	0,41 0.016
SD522-46-92-40R7	03080835	46,0 1.811	92,0 3.622	190,0 7.480	97,0 3.819	122,0 4.803	68,0 2.677	40,0 1.575	50,0 1.969	SPGX1504	SCGX150512	0,5 0.020	0,5 0.020
SD522-47-94-40R7	03080836	47,0 1.850	94,0 3.701	192,0 7.559	99,0 3.898	124,0 4.882	68,0 2.677	40,0 1.575	50,0 1.969	SPGX1504	SCGX150512	0,5 0.020	0,5 0.020
SD522-48-96-40R7	03080837	48,0 1.890	96,0 3.780	194,0 7.638	101,0 3.976	126,0 4.961	68,0 2.677	40,0 1.575	59,35 2.337	SPGX1504	SCGX150512	0,45 0.018	0,5 0.020
SD522-49-98-40R7	03080838	49,0 1.929	98,0 3.858	196,0 7.717	103,0 4.055	128,0 5.039	68,0 2.677	40,0 1.575	59,35 2.337	SPGX1504	SCGX150512	0,2 0.008	0,5 0.020
SD522-50-100-40R7	03080839	50,0 1.969	100,0 3.937	198,0 7.795	105,0 4.134	130,0 5.118	68,0 2.677	40,0 1.575	59,35 2.337	SPGX1504	SCGX150512	0,2 0.008	0,5 0.020
SD522-51-102-40R7	03080840	51,0 2.008	102,0 4.016	200,0 7.874	107,0 4.213	132,0 5.197	68,0 2.677	40,0 1.575	59,35 2.337	SPGX1504	SCGX150512	0,2 0.008	0,5 0.020
SD522-52-104-40R7	03080841	52,0 2.047	104,0 4.094	202,0 7.953	109,0 4.291	134,0 5.276	68,0 2.677	40,0 1.575	59,35 2.337	SPGX1904	SCGX150512	0,5 0.020	0,42 0.017
SD522-53-106-40R7	03080842	53,0 2.087	106,0 4.173	204,0 8.031	111,0 4.370	136,0 5.354	68,0 2.677	40,0 1.575	59,35 2.337	SPGX1904	SCGX150512	0,5 0.020	0,42 0.017
SD522-54-108-40R7	03080843	54,0 2.126	108,0 4.252	206,0 8.110	113,0 4.449	138,0 5.433	68,0 2.677	40,0 1.575	59,35 2.337	SPGX1904	SCGX150512	0,5 0.020	0,5 0.020
SD522-55-110-40R7	03080844	55,0 2.165	110,0 4.331	208,0 8.189	115,0 4.528	140,0 5.512	68,0 2.677	40,0 1.575	59,35 2.337	SPGX1904	SCGX150512	0,5 0.020	0,5 0.020
SD522-56-112-40R7	03080845	56,0 2.205	112,0 4.409	210,0 8.268	117,0 4.606	142,0 5.591	68,0 2.677	40,0 1.575	59,35 2.337	SPGX1904	SCGX150512	0,5 0.020	0,5 0.020
SD522-57-114-40R7	03080846	57,0 2.244	114,0 4.488	212,0 8.346	119,0 4.685	144,0 5.669	68,0 2.677	40,0 1.575	59,35 2.337	SPGX1904	SCGX150512	0,39 0.015	0,5 0.020
SD522-58-116-40R7	03080847	58,0 2.283	116,0 4.567	214,0 8.425	121,0 4.764	146,0 5.748	68,0 2.677	40,0 1.575	63,0 2.480	SPGX1904	SCGX150512	0,09 0.004	0,5 0.020
SD522-59-118-40R7	03080848	59,0 2.323	118,0 4.646	216,0 8.504	123,0 4.843	148,0 5.827	68,0 2.677	40,0 1.575	63,0 2.480	SPGX1904	SCGX150512	0,09 0.004	0,5 0.020

Części zamienne, zawarte w dostawie

Dla śred. wiertła (mm)	Śruba mocująca płytkę		Klucz do płytek
			
	Płytki centralna	Płytki zewn.	
15,00-17,45	C02245-T07P	C02245-T07P	T07P-2
17,46-19,49	C02205-T07P	C02245-T07P	T07P-2
19,50-21,24	C02205-T07P	C02205-T07P	T07P-2
21,25-22,49	C02506-T08P	C02506-T08P	T08P-2
22,50-25,49	C02507-T08P	C03007-T08P	T08P-2
25,50-28,49	C03007-T09P	C03007-T09P	T09P-2
28,50-31,49	C03007-T09P	C03009-T09P	T09P-2
31,50-40,49	C03508-T15P	C03508-T15P	T15P-2D
40,50-43,24	C03508-T15P	C05012-T15P	T15P-2D
43,25-59,00	C04011-T15P	C05012-T15P	T15P-2D

Akcesoria

Dla śred. wiertła (mm)	Klucz dynamometryczny*	Wkładka wymienna	Wielk. mom.
			
15,00-17,45	T00-07P09	T00-07P	0,9 Nm
17,46-19,49	T00-07P09	T00-07P	0,9 Nm
19,50-21,24	T00-07P09	T00-07P	0,9 Nm
21,25-22,49	T00-08P12	T00-08P	1,2 Nm
22,50-25,49	T00-08P12	T00-08P	1,2 Nm
25,50-28,49	T00-09P20	T00-09P	2,0 Nm
28,50-31,49	T00-09P20	T00-09P	2,0 Nm
31,50-40,49	T00-15P30	T00-15P	3,0 Nm
40,50-43,24	T00-15P30	T00-15P	3,0 Nm
43,25-59,00	T00-15P30	T00-15P	3,0 Nm

*Zawiera płytkę.

SD522

Głębokość wiercenia ~ 2 x D – Calowe

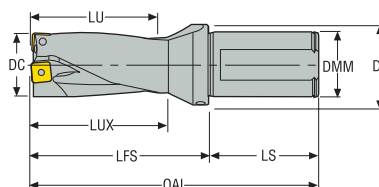



- Chwył ISO 9766, R7
- Chłodzenie wewnętrzne
- Informacja na temat płytek patrz str. 292-298
- Parametry skrawania, patrz strona (strony) 299, 300
- Średnice pośrednie patrz aplikacja MyDesign.

Oznaczenie	Numer produktu	DC	LU	OAL	LUX	LFS	LS	DMM	DF	Płytki		Regulacja promieniowa	
										Płytki centralna	Płytki peryferyjna	Cal. -	Cal. +
SD522-0594-119-1000R7	03080704	0.594	1.190	4.621	1.387	2.371	2.250	1.000	1.378	SPGX0502	SCGX050204	0.008	0.013
SD522-0625-125-1000R7	03080705	0.625	1.250	4.681	1.447	2.431	2.250	1.000	1.378	SPGX0502	SCGX050204	0.005	0.015
SD522-0656-131-1000R7	03080707	0.656	1.310	4.741	1.507	2.491	2.250	1.000	1.378	SPGX0502	SCGX050204	0.002	0.019
SD522-0687-137-1000R7	03080709	0.687	1.370	4.801	1.567	2.551	2.250	1.000	1.378	SPGX0502	SCGX050204	0	0.020
SD522-0709-142-1000R7	03080710	0.709	1.420	4.851	1.617	2.601	2.250	1.000	1.378	SPGX0602	SCGX050204	0.013	0.008
SD522-0750-150-1000R7	03080712	0.750	1.500	4.931	1.697	2.681	2.250	1.000	1.378	SPGX0602	SCGX050204	0.004	0.017
SD522-0766-153-1000R7	03080713	0.766	1.530	4.961	1.727	2.711	2.250	1.000	1.378	SPGX0602	SCGX050204	0.001	0.020
SD522-0787-157-1000R7	03080714	0.787	1.570	5.001	1.767	2.751	2.250	1.000	1.378	SPGX0602	SCGX060204	0.003	0.018
SD522-0812-162-1000R7	03080715	0.812	1.620	5.051	1.817	2.801	2.250	1.000	1.378	SPGX0602	SCGX060204	0.001	0.020
SD522-0827-165-1000R7	03080717	0.827	1.650	5.081	1.847	2.831	2.250	1.000	1.378	SPGX0602	SCGX060204	0	0.020
SD522-0875-175-1000R7	03080718	0.875	1.750	5.181	1.947	2.931	2.250	1.000	1.378	SPGX0703	SCGX060204	0.015	0.020
SD522-0906-181-1000R7	03080720	0.906	1.810	5.241	2.007	2.991	2.250	1.000	1.378	SPGX0703	SCGX070308	0.013	0.020
SD522-0922-184-1000R7	03080721	0.922	1.840	5.271	2.037	3.021	2.250	1.000	1.378	SPGX0703	SCGX070308	0.010	0.020
SD522-0937-187-1000R7	03080722	0.937	1.870	5.301	2.067	3.051	2.250	1.000	1.378	SPGX0703	SCGX070308	0.004	0.020
SD522-0984-197-1250R7	03080724	0.984	1.970	5.526	2.167	3.151	2.375	1.250	1.654	SPGX0703	SCGX070308	0.004	0.020
SD522-1000-200-1250R7	03080725	1.000	2.000	5.556	2.197	3.181	2.375	1.250	1.654	SPGX0703	SCGX070308	0.004	0.020
SD522-1032-206-1250R7	03080727	1.032	2.060	5.616	2.257	3.241	2.375	1.250	1.654	SPGX0903	SCGX070308	0.020	0.004
SD522-1062-212-1250R7	03080728	1.062	2.120	5.676	2.317	3.301	2.375	1.250	1.654	SPGX0903	SCGX070308	0.020	0.010
SD522-1125-225-1250R7	03080730	1.125	2.250	5.806	2.447	3.431	2.375	1.250	1.654	SPGX0903	SCGX09T308	0.008	0.020
SD522-1187-237-1250R7	03080732	1.187	2.370	5.926	2.567	3.551	2.375	1.250	1.654	SPGX0903	SCGX09T308	0.005	0.020
SD522-1250-250-1500R7	03080735	1.250	2.500	6.306	2.697	3.681	2.625	1.500	1.969	SPGX11T3	SCGX09T308	0.020	0.011
SD522-1312-262-1500R7	03080736	1.312	2.620	6.426	2.817	3.801	2.625	1.500	1.969	SPGX11T3	SCGX09T308	0.020	0.020
SD522-1375-275-1500R7	03080737	1.375	2.750	6.556	2.947	3.931	2.625	1.500	1.969	SPGX11T3	SCGX11T308	0.009	0.020
SD522-1437-287-1500R7	03080739	1.437	2.870	6.676	3.067	4.051	2.625	1.500	1.969	SPGX11T3	SCGX11T308	0.004	0.020
SD522-1500-300-1500R7	03080743	1.500	3.000	6.806	3.197	4.181	2.625	1.500	1.969	SPGX12T3	SCGX11T308	0.020	0.020
SD522-1625-325-1500R7	03080748	1.625	3.250	7.056	3.447	4.431	2.625	1.500	1.969	SPGX12T3	SCGX120408	0.007	0.020
SD522-1750-350-1500R7	03080756	1.750	3.500	7.306	3.697	4.681	2.625	1.500	1.969	SPGX1504	SCGX120408	0.020	0.016
SD522-1875-375-1500R7	03080763	1.875	3.750	7.556	3.947	4.931	2.625	1.500	1.969	SPGX1504	SCGX150512	0.020	0.020
SD522-2000-400-1500R7	03080769	2.000	4.000	7.806	4.197	5.181	2.625	1.500	2.337	SPGX1504	SCGX150512	0.008	0.020
SD522-2125-425-1500R7	03080773	2.125	4.250	8.056	4.447	5.431	2.625	1.500	2.337	SPGX1904	SCGX150512	0.020	0.020
SD522-2250-450-1500R7	03080779	2.250	4.500	8.306	4.697	5.681	2.625	1.500	2.337	SPGX1904	SCGX150512	0.013	0.020
SD522-2375-475-1500R7	03080783	2.375	4.750	8.556	4.947	5.931	2.625	1.500	2.480	SPGX1904	SCGX150512	0.004	0.020

Części zamienne, zawarte w dostawie

Dla śred. wiertła (cale)	Śruba mocująca płytkę		Klucz do płytek
			
	Płytki centralna	Płytki zewn.	
0.594-0.687	C02245-T07P	C02245-T07P	T07P-2
0.709-0.766	C02205-T07P	C02245-T07P	T07P-2
0.787	C02205-T07P	C02205-T07P	T07P-2
0.812-0.827	C02205-T07P	C02205-T07P	T07P-2
0.875	C02506-T08P	C02506-T08P	T08P-2
0.906-1.000	C02507-T08P	C03007-T08P	T08P-2
1.032-1.062	C03007-T09P	C03007-T09P	T09P-2
1.125-1.187	C03007-T09P	C03009-T09P	T09P-2
1.250-1.500	C03508-T15P	C03508-T15P	T15P-2D
1.625	C03508-T15P	C05012-T15P	T15P-2D
1.750-2.375	C04011-T15P	C05012-T15P	T15P-2D

Akcesoria

Dla śred. wiertła (cale)	Klucz dynamometryczny*	Wkładka wymienna	Wielk. mom.
			
0.594-0.687	T00-07P09	T00-07P	8 in/lbs
0.709-0.766	T00-07P09	T00-07P	8 in/lbs
0.787	T00-07P09	T00-07P	8 in/lbs
0.812-0.827	T00-07P09	T00-07P	8 in/lbs
0.875	T00-08P12	T00-08P	10.6 in/lbs
0.906-1.000	T00-08P12	T00-08P	10.6 in/lbs
1.032-1.062	T00-09P20	T00-09P	17.7 in/lbs
1.125-1.187	T00-09P20	T00-09P	17.7 in/lbs
1.250-1.500	T00-15P30	T00-15P	26.6 in/lbs
1.625	T00-15P30	T00-15P	26.6 in/lbs
1.750-2.375	T00-15P30	T00-15P	26.6 in/lbs

*Zawiera płytkę.

SD522

Głębokość wiercenia ~ 2 x D – Calowe

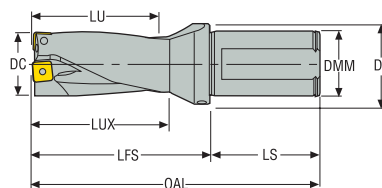

- Chwyt ISO 9766, R7-C
- Chłodzenie wewnętrzne
- Informacja na temat płytek patrz str. 292-298
- Parametry skrawania, patrz strona (strony) 299-300
- Średnice pośrednie patrz aplikacja MyDesign.
- Do zastosowań stacjonarnych

Oznaczenie	Numer produktu	DC	LU	OAL	LUX	LFS	LS	DMM	DF	Płytki		Regulacja promieniowa	
										Płytki centralna	Płytki peryferyjna	Cal. -	Cal. +
SD522-0625-125-1000R7-C	03080706	0.625	1.250	5.378	1.447	2.628	2.750	1.000	1.378	SPGX0502	SCGX050204	0.005	0.015
SD522-0687-137-1000R7-C	03080708	0.687	1.370	5.498	1.567	2.748	2.750	1.000	1.378	SPGX0502	SCGX050204	0	0.020
SD522-0750-150-1000R7-C	03080711	0.750	1.500	5.628	1.697	2.878	2.750	1.000	1.378	SPGX0602	SCGX050204	0.004	0.017
SD522-0812-162-1000R7-C	03080716	0.812	1.620	5.748	1.817	2.998	2.750	1.000	1.378	SPGX0602	SCGX060204	0.001	0.020
SD522-0875-175-1000R7-C	03080719	0.875	1.750	5.878	1.947	3.128	2.750	1.000	1.378	SPGX0703	SCGX060204	0.015	0.020
SD522-0937-187-1000R7-C	03080723	0.937	1.870	5.998	2.067	3.248	2.750	1.000	1.378	SPGX0703	SCGX070308	0.004	0.020
SD522-1000-200-1250R7-C	03080726	1.000	2.000	6.128	2.197	3.378	2.750	1.250	1.654	SPGX0703	SCGX070308	0.004	0.020
SD522-1062-212-1250R7-C	03080729	1.062	2.120	6.248	2.317	3.498	2.750	1.250	1.654	SPGX0903	SCGX070308	0.020	0.010
SD522-1125-225-1250R7-C	03080731	1.125	2.250	6.378	2.447	3.628	2.750	1.250	1.654	SPGX0903	SCGX09T308	0.008	0.020
SD522-1187-237-1250R7-C	03080733	1.187	2.370	6.498	2.567	3.748	2.750	1.250	1.654	SPGX0903	SCGX09T308	0.005	0.020
SD522-1250-250-1500R7-C	03080734	1.250	2.500	6.628	2.697	3.878	2.750	1.500	1.969	SPGX11T3	SCGX09T308	0.020	0.011
SD522-1375-275-1500R7-C	03080738	1.375	2.750	6.878	2.947	4.128	2.750	1.500	1.969	SPGX11T3	SCGX11T308	0.009	0.020
SD522-1500-300-1500R7-C	03080742	1.500	3.000	7.128	3.197	4.378	2.750	1.500	1.969	SPGX12T3	SCGX11T308	0.020	0.020
SD522-1750-350-1500R7-C	03080757	1.750	3.500	7.628	3.697	4.878	2.750	1.500	1.969	SPGX1504	SCGX120408	0.020	0.016
SD522-2000-400-1500R7-C	03080770	2.000	4.000	8.128	4.197	5.378	2.750	1.500	2.337	SPGX1504	SCGX150512	0.008	0.020
SD522-2125-425-1500R7-C	03080774	2.125	4.250	8.378	4.447	5.628	2.750	1.500	2.337	SPGX1904	SCGX150512	0.020	0.020
SD522-2250-450-1500R7-C	03080780	2.250	4.500	8.628	4.697	5.878	2.750	1.500	2.337	SPGX1904	SCGX150512	0.013	0.020
SD522-2375-475-1500R7-C	03080784	2.375	4.750	8.878	4.947	6.128	2.750	1.500	2.480	SPGX1904	SCGX150512	0.004	0.020

Części zamienne, zawarte w dostawie

Akcesoria

Dla śred. wiertła (cale)	Adapter przewodu	Śruba do płytki centralnej	Śruba do płytki zewnętrznej	Klucz	Zaślepka	Klucz dynamometryczny
0.625	1310	C02245-T07P	C02245-T07P	T07P-2	R1/4	T00-07P09
0.687	1310	C02245-T07P	C02245-T07P	T07P-2	R1/4	T00-07P09
0.750	1310	C02205-T07P	C02245-T07P	T07P-2	R1/4	T00-07P09
0.812	1310	C02205-T07P	C02205-T07P	T07P-2	R1/4	T00-07P09
0.875	1310	C02506-T08P	C02506-T08P	T08P-2	R1/4	T00-08P12
0.937-1.000	1310	C02507-T08P	C03007-T08P	T08P-2	R1/4	T00-08P12
1.062	1310	C03007-T09P	C03007-T09P	T09P-2	R1/4	T00-09P20
1.125-1.187	1310	C03007-T09P	C03009-T09P	T09P-2	R1/4	T00-09P20
1.250-1.500	1310	C03508-T15P	C03508-T15P	T15P-2D	R1/4	T00-15P30
1.750-2.375	1310	C04011-T15P	C05012-T15P	T15P-2D	R1/4	T00-15P35

SD522

Głębokość wiercenia ~ 2 x D – Metryczne/Calowe

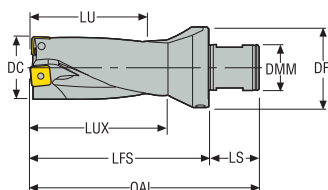

- Chwyt zgodny z ABS 50, R2
- Chłodzenie wewnętrzne
- Informacja na temat płytek patrz str. 292-298
- Parametry skrawania, patrz strona (strony) 299, 300
- Średnice pośrednie patrz aplikacja MyDesign.



Oznaczenie	Numer produktu	DC	LU	OAL	LUX	LFS	LS	DMM	DF	Płytki		Regulacja promieniowa	
										Płytki centralna	Płytki peryferyjna	mm - Cal. -	mm + Cal. +
SD522-15-30-50R2	03081056	15,0 0.591	30,0 1.181	91,0 3.583	35,0 1.378	60,0 2.362	31,0 1.220	28,0 1.102	50,0 1.969	SPGX0502	SCGX050204	0,22 0.009	0,31 0.012
SD522-15.5-31-50R2	03081057	15,5 0.610	31,0 1.220	92,0 3.622	36,0 1.417	61,0 2.402	31,0 1.220	28,0 1.102	50,0 1.969	SPGX0502	SCGX050204	0,17 0.007	0,36 0.014
SD522-16-32-50R2	03080751	16,0 0.630	32,0 1.260	93,0 3.661	37,0 1.457	62,0 2.441	31,0 1.220	28,0 1.102	50,0 1.969	SPGX0502	SCGX050204	0,12 0.005	0,41 0.016
SD522-16.5-33-50R2	03081058	16,5 0.650	33,0 1.299	94,0 3.701	38,0 1.496	63,0 2.480	31,0 1.220	28,0 1.102	50,0 1.969	SPGX0502	SCGX050204	0,07 0.003	0,46 0.018
SD522-17-34-50R2	03081059	17,0 0.669	34,0 1.339	95,0 3.740	39,0 1.535	64,0 2.520	31,0 1.220	28,0 1.102	50,0 1.969	SPGX0502	SCGX050204	0,02 0.001	0,5 0.020
SD522-17.5-35-50R2	03081060	17,5 0.689	35,0 1.378	96,0 3.780	40,0 1.575	65,0 2.559	31,0 1.220	28,0 1.102	50,0 1.969	SPGX0602	SCGX050204	0,43 0.017	0,1 0.004
SD522-18-36-50R2	03080762	18,0 0.709	36,0 1.417	97,0 3.819	41,0 1.614	66,0 2.598	31,0 1.220	28,0 1.102	50,0 1.969	SPGX0602	SCGX050204	0,32 0.013	0,21 0.008
SD522-18.5-37-50R2	03081061	18,5 0.728	37,0 1.457	98,0 3.858	42,0 1.654	67,0 2.638	31,0 1.220	28,0 1.102	50,0 1.969	SPGX0602	SCGX050204	0,22 0.009	0,31 0.012
SD522-19-38-50R2	03080767	19,0 0.748	38,0 1.496	99,0 3.898	43,0 1.693	68,0 2.677	31,0 1.220	28,0 1.102	50,0 1.969	SPGX0602	SCGX050204	0,11 0.004	0,42 0.017
SD522-20-40-50R2	03080772	20,0 0.787	40,0 1.575	101,0 3.976	45,0 1.772	70,0 2.756	31,0 1.220	28,0 1.102	50,0 1.969	SPGX0602	SCGX060204	0,07 0.003	0,46 0.018
SD522-20.62-42-50R2	03080768	20,62 0.812	42,0 1.654	103,0 4.055	47,0 1.850	72,0 2.835	31,0 1.220	28,0 1.102	50,0 1.969	SPGX0602	SCGX060204	0,03 0.001	0,5 0.020
SD522-21-42-50R2	03081062	21,0 0.827	42,0 1.654	103,0 4.055	47,0 1.850	72,0 2.835	31,0 1.220	28,0 1.102	50,0 1.969	SPGX0602	SCGX060204	0,01 0	0,5 0.020
SD522-22-44-50R2	03080778	22,0 0.866	44,0 1.732	105,0 4.134	49,0 1.929	74,0 2.913	31,0 1.220	28,0 1.102	50,0 1.969	SPGX0703	SCGX060204	0,44 0.017	0,46 0.018
SD522-22.23-45-50R2	03080776	22,23 0.875	45,0 1.772	106,0 4.173	50,0 1.969	75,0 2.953	31,0 1.220	28,0 1.102	50,0 1.969	SPGX0703	SCGX060204	0,39 0.015	0,5 0.020
SD522-23-46-50R2	03080782	23,0 0.906	46,0 1.811	107,0 4.213	51,0 2.008	76,0 2.992	31,0 1.220	28,0 1.102	50,0 1.969	SPGX0703	SCGX070308	0,33 0.013	0,5 0.020
SD522-24-48-50R2	03080786	24,0 0.945	48,0 1.890	109,0 4.291	53,0 2.087	78,0 3.071	31,0 1.220	28,0 1.102	50,0 1.969	SPGX0703	SCGX070308	0,11 0.004	0,5 0.020
SD522-25-50-50R2	03080789	25,0 0.984	50,0 1.969	111,0 4.370	55,0 2.165	80,0 3.150	31,0 1.220	28,0 1.102	50,0 1.969	SPGX0703	SCGX070308	0,11 0.004	0,5 0.020
SD522-25.40-51-50R2	03080787	25,4 1.000	51,0 2.008	112,0 4.409	56,0 2.205	81,0 3.189	31,0 1.220	28,0 1.102	50,0 1.969	SPGX0703	SCGX070308	0,11 0.004	0,5 0.020
SD522-26-52-50R2	03080791	26,0 1.024	52,0 2.047	113,0 4.449	57,0 2.244	82,0 3.228	31,0 1.220	28,0 1.102	50,0 1.969	SPGX0903	SCGX070308	0,5 0.020	0,11 0.004
SD522-27-54-50R2	03080793	27,0 1.063	54,0 2.126	115,0 4.528	59,0 2.323	84,0 3.307	31,0 1.220	28,0 1.102	50,0 1.969	SPGX0903	SCGX070308	0,5 0.020	0,26 0.010
SD522-28-56-50R2	03081087	28,0 1.102	56,0 2.205	117,0 4.606	61,0 2.402	86,0 3.386	31,0 1.220	28,0 1.102	50,0 1.969	SPGX0903	SCGX070308	0,28 0.011	0,5 0.020

Oznaczenie	Numer produktu	DC	LU	OAL	LUX	LFS	LS	DMM	DF	Płytki		Regulacja promieniowa	
		mm Cal.	mm Cal.	mm Cal.	mm Cal.	mm Cal.	mm Cal.	mm Cal.	mm Cal.	mm Cal.	Płytki centralna	Płytki peryferyjna	mm - Cal. -
SD522-28.59-58-50R2	03080794	28,59 1.126	58,0 2.283	119,0 4.685	63,0 2.480	88,0 3.465	31,0 1.220	28,0 1.102	50,0 1.969	SPGX0903	SCGX09T308	0,21 0.008	0,5 0.020
SD522-29.58-50R2	03080797	29,0 1.142	58,0 2.283	119,0 4.685	63,0 2.480	88,0 3.465	31,0 1.220	28,0 1.102	50,0 1.969	SPGX0903	SCGX09T308	0,18 0.007	0,5 0.020
SD522-30.60-50R2	03080799	30,0 1.181	60,0 2.362	121,0 4.764	65,0 2.559	90,0 3.543	31,0 1.220	28,0 1.102	50,0 1.969	SPGX0903	SCGX09T308	0,12 0.005	0,5 0.020
SD522-31.62-50R2	03081063	31,0 1.220	62,0 2.441	123,0 4.843	67,0 2.638	92,0 3.622	31,0 1.220	28,0 1.102	50,0 1.969	SPGX0903	SCGX09T308	0,12 0.005	0,5 0.020
SD522-31.75-64-50R2	03080800	31,75 1.250	64,0 2.520	125,0 4.921	69,0 2.717	94,0 3.701	31,0 1.220	28,0 1.102	50,0 1.969	SPGX11T3	SCGX09T308	0,5 0.020	0,28 0.011
SD522-32.64-50R2	03080804	32,0 1.260	64,0 2.520	125,0 4.921	69,0 2.717	94,0 3.701	31,0 1.220	28,0 1.102	50,0 1.969	SPGX11T3	SCGX09T308	0,5 0.020	0,31 0.012
SD522-33.66-50R2	03080807	33,0 1.299	66,0 2.598	127,0 5.000	71,0 2.795	96,0 3.780	31,0 1.220	28,0 1.102	50,0 1.969	SPGX11T3	SCGX09T308	0,5 0.020	0,46 0.018
SD522-34.68-50R2	03081064	34,0 1.339	68,0 2.677	129,0 5.079	73,0 2.874	98,0 3.858	31,0 1.220	28,0 1.102	50,0 1.969	SPGX11T3	SCGX09T308	0,22 0.009	0,5 0.020
SD522-35.70-50R2	03080812	35,0 1.378	70,0 2.756	131,0 5.157	75,0 2.953	100,0 3.937	31,0 1.220	28,0 1.102	50,0 1.969	SPGX11T3	SCGX11T308	0,22 0.009	0,5 0.020
SD522-36.72-50R2	03080815	36,0 1.417	72,0 2.835	133,0 5.236	77,0 3.031	102,0 4.016	31,0 1.220	28,0 1.102	50,0 1.969	SPGX11T3	SCGX11T308	0,09 0.004	0,5 0.020
SD522-37.74-50R2	03081065	37,0 1.457	74,0 2.913	135,0 5.315	79,0 3.110	104,0 4.094	31,0 1.220	28,0 1.102	50,0 1.969	SPGX11T3	SCGX11T308	0,09 0.004	0,5 0.020
SD522-38.76-50R2	03080820	38,0 1.496	76,0 2.992	137,0 5.394	81,0 3.189	106,0 4.173	31,0 1.220	28,0 1.102	50,0 1.969	SPGX12T3	SCGX11T308	0,5 0.020	0,5 0.020
SD522-39.78-50R2	03081066	39,0 1.535	78,0 3.071	139,0 5.472	83,0 3.268	108,0 4.252	31,0 1.220	28,0 1.102	50,0 1.969	SPGX12T3	SCGX11T308	0,39 0.015	0,5 0.020
SD522-40.80-50R2	03080825	40,0 1.575	80,0 3.150	141,0 5.551	85,0 3.346	110,0 4.331	31,0 1.220	28,0 1.102	50,0 1.969	SPGX12T3	SCGX11T308	0,19 0.007	0,5 0.020
SD522-41.82-50R2	03080827	41,0 1.614	82,0 3.228	143,0 5.630	87,0 3.425	112,0 4.409	31,0 1.220	28,0 1.102	50,0 1.969	SPGX12T3	SCGX120408	0,19 0.007	0,5 0.020
SD522-42.84-50R2	03080829	42,0 1.654	84,0 3.307	145,0 5.709	89,0 3.504	114,0 4.488	31,0 1.220	28,0 1.102	50,0 1.969	SPGX12T3	SCGX120408	0,19 0.007	0,5 0.020
SD522-43.86-50R2	03081067	43,0 1.693	86,0 3.386	147,0 5.787	91,0 3.583	116,0 4.567	31,0 1.220	28,0 1.102	50,0 1.969	SPGX12T3	SCGX120408	0,05 0.002	0,5 0.020
SD522-44.45-89-50R2	03080831	44,45 1.750	89,0 3.504	150,0 5.906	94,0 3.701	119,0 4.685	31,0 1.220	50,0 1.969	50,0 1.969	SPGX1504	SCGX120408	0,5 0.020	0,41 0.016

Części zamienne, zawarte w dostawie

Dla śred. wiertła (mm)	Śruba mocująca płytkę		Klucz do płytek
			
	Płytki centralna	Płytki zewn.	
15,00-17,45	C02245-T07P	C02245-T07P	T07P-2
17,46-19,49	C02205-T07P	C02245-T07P	T07P-2
19,50-21,24	C02205-T07P	C02205-T07P	T07P-2
21,25-22,49	C02506-T08P	C02506-T08P	T08P-2
22,50-25,49	C02507-T08P	C03007-T08P	T08P-2
25,50-28,49	C03007-T09P	C03007-T09P	T09P-2
28,50-31,49	C03007-T09P	C03009-T09P	T09P-2
31,50-40,49	C03508-T15P	C03508-T15P	T15P-2D
40,50-43,24	C03508-T15P	C05012-T15P	T15P-2D
43,25-59,00	C04011-T15P	C05012-T15P	T15P-2D

Akcesoria

Dla śred. wiertła (mm)	Klucz dynamometryczny*	Wkładka wymienna	Wielk. mom.
			
15,00-17,45	T00-07P09	T00-07P	0,9 Nm
17,46-19,49	T00-07P09	T00-07P	0,9 Nm
19,50-21,24	T00-07P09	T00-07P	0,9 Nm
21,25-22,49	T00-08P12	T00-08P	1,2 Nm
22,50-25,49	T00-08P12	T00-08P	1,2 Nm
25,50-28,49	T00-09P20	T00-09P	2,0 Nm
28,50-31,49	T00-09P20	T00-09P	2,0 Nm
31,50-40,49	T00-15P30	T00-15P	3,0 Nm
40,50-43,24	T00-15P30	T00-15P	3,0 Nm
43,25-59,00	T00-15P30	T00-15P	3,0 Nm

*Zawiera płytkę.

Wstęp

Wiercenie

Rozwiercanie

Wytaczanie

Załącznik

SD523

Głębokość wiercenia ~ 3 x D – Metryczne/Calowe

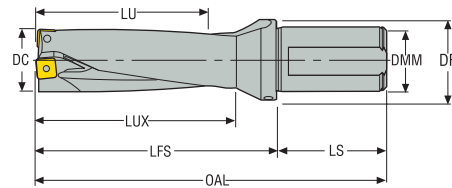

- Chwył ISO 9766, -7
- Chłodzenie wewnętrzne
- Informacja na temat płytek patrz str. 292-298
- Parametry skrawania, patrz strona (strony) 301-302
- Średnice pośrednie patrz aplikacja MyDesign.

Oznaczenie	Numer produktu	DC	LU	OAL	LUX	LFS	LS	DMM	DF	Płytki		Regulacja promieniowa	
										Płytki centralna	Płytki peryferyjna	mm - Cal. -	mm + Cal. +
SD523-15-45-20R7	03080548	15,0 0.591	45,0 1.772	125,0 4.921	50,0 1.969	75,0 2.953	50,0 1.969	20,0 0.787	30,0 1.181	SPGX0502	SCGX050204	0,22 0.009	0,31 0.012
SD523-15-45-25R7	03080549	15,0 0.591	45,0 1.772	131,0 5.157	50,0 1.969	75,0 2.953	56,0 2.205	25,0 0.984	35,0 1.378	SPGX0502	SCGX050204	0,22 0.009	0,31 0.012
SD523-15.5-47-20R7	03080544	15,5 0.610	47,0 1.850	127,0 5.000	52,0 2.047	77,0 3.031	50,0 1.969	20,0 0.787	30,0 1.181	SPGX0502	SCGX050204	0,17 0.007	0,36 0.014
SD523-15.5-47-25R7	03080545	15,5 0.610	47,0 1.850	133,0 5.236	52,0 2.047	77,0 3.031	56,0 2.205	25,0 0.984	35,0 1.378	SPGX0502	SCGX050204	0,17 0.007	0,36 0.014
SD523-16-48-20R7	03080557	16,0 0.630	48,0 1.890	128,0 5.039	53,0 2.087	78,0 3.071	50,0 1.969	20,0 0.787	30,0 1.181	SPGX0502	SCGX050204	0,12 0.005	0,41 0.016
SD523-16-48-25R7	03080558	16,0 0.630	48,0 1.890	134,0 5.276	53,0 2.087	78,0 3.071	56,0 2.205	25,0 0.984	35,0 1.378	SPGX0502	SCGX050204	0,12 0.005	0,41 0.016
SD523-16.5-50-20R7	03080552	16,5 0.650	50,0 1.969	130,0 5.118	55,0 2.165	80,0 3.150	50,0 1.969	20,0 0.787	30,0 1.181	SPGX0502	SCGX050204	0,07 0.003	0,46 0.018
SD523-16.5-50-25R7	03080554	16,5 0.650	50,0 1.969	136,0 5.354	55,0 2.165	80,0 3.150	56,0 2.205	25,0 0.984	35,0 1.378	SPGX0502	SCGX050204	0,07 0.003	0,46 0.018
SD523-17-51-20R7	03080568	17,0 0.669	51,0 2.008	131,0 5.157	56,0 2.205	81,0 3.189	50,0 1.969	20,0 0.787	30,0 1.181	SPGX0502	SCGX050204	0,02 0.001	0,5 0.020
SD523-17-51-25R7	03080569	17,0 0.669	51,0 2.008	137,0 5.394	56,0 2.205	81,0 3.189	56,0 2.205	25,0 0.984	35,0 1.378	SPGX0502	SCGX050204	0,02 0.001	0,5 0.020
SD523-17.5-53-20R7	03080562	17,5 0.689	53,0 2.087	133,0 5.236	58,0 2.283	83,0 3.268	50,0 1.969	20,0 0.787	30,0 1.181	SPGX0602	SCGX050204	0,43 0.017	0,1 0.004
SD523-17.5-53-25R7	03080563	17,5 0.689	53,0 2.087	139,0 5.472	58,0 2.283	83,0 3.268	56,0 2.205	25,0 0.984	35,0 1.378	SPGX0602	SCGX050204	0,43 0.017	0,1 0.004
SD523-18-54-20R7	03080574	18,0 0.709	54,0 2.126	134,0 5.276	59,0 2.323	84,0 3.307	50,0 1.969	20,0 0.787	30,0 1.181	SPGX0602	SCGX050204	0,32 0.013	0,21 0.008
SD523-18-54-25R7	03080575	18,0 0.709	54,0 2.126	140,0 5.512	59,0 2.323	84,0 3.307	56,0 2.205	25,0 0.984	35,0 1.378	SPGX0602	SCGX050204	0,32 0.013	0,21 0.008
SD523-18.5-56-20R7	03080570	18,5 0.728	56,0 2.205	136,0 5.354	61,0 2.402	86,0 3.386	50,0 1.969	20,0 0.787	30,0 1.181	SPGX0602	SCGX050204	0,22 0.009	0,31 0.012
SD523-18.5-56-25R7	03080571	18,5 0.728	56,0 2.205	142,0 5.591	61,0 2.402	86,0 3.386	56,0 2.205	25,0 0.984	35,0 1.378	SPGX0602	SCGX050204	0,22 0.009	0,31 0.012
SD523-19-57-20R7	03080583	19,0 0.748	57,0 2.244	137,0 5.394	62,0 2.441	87,0 3.425	50,0 1.969	20,0 0.787	30,0 1.181	SPGX0602	SCGX050204	0,11 0.004	0,42 0.017
SD523-19-57-25R7	03080584	19,0 0.748	57,0 2.244	143,0 5.630	62,0 2.441	87,0 3.425	56,0 2.205	25,0 0.984	35,0 1.378	SPGX0602	SCGX050204	0,11 0.004	0,42 0.017
SD523-19.5-59-20R7	03080579	19,5 0.768	59,0 2.323	139,0 5.472	64,0 2.520	89,0 3.504	50,0 1.969	20,0 0.787	30,0 1.181	SPGX0602	SCGX060204	0,11 0.004	0,42 0.017
SD523-19.5-59-25R7	03080580	19,5 0.768	59,0 2.323	145,0 5.709	64,0 2.520	89,0 3.504	56,0 2.205	25,0 0.984	35,0 1.378	SPGX0602	SCGX060204	0,11 0.004	0,42 0.017
SD523-20-60-25R7	03080590	20,0 0.787	60,0 2.362	146,0 5.748	65,0 2.559	90,0 3.543	56,0 2.205	25,0 0.984	35,0 1.378	SPGX0602	SCGX060204	0,07 0.003	0,46 0.018
SD523-20.5-62-25R7	03080586	20,5 0.807	62,0 2.441	148,0 5.827	67,0 2.638	92,0 3.622	56,0 2.205	25,0 0.984	35,0 1.378	SPGX0602	SCGX060204	0,04 0.002	0,49 0.019

Wstęp

Wiercenie

Rozwiercanie

Wyłaczanie

Załącznik

Oznaczenie	Numer produktu	DC	LU	OAL	LUX	LFS	LS	DMM	DF	Płytki		Regulacja promieniowa	
		mm Cal.	mm Cal.	mm Cal.	mm Cal.	mm Cal.	mm Cal.	mm Cal.	mm Cal.	Płytki centralna	Płytki peryferyjna	mm - Cal. -	mm + Cal. +
SD523-21-63-25R7	03080599	21,0 0.827	63,0 2.480	149,0 5.866	68,0 2.677	93,0 3.661	56,0 2.205	25,0 0.984	35,0 1.378	SPGX0602	SCGX060204	0,01 0	0,5 0.020
SD523-21.5-65-25R7	03080595	21,5 0.846	65,0 2.559	151,0 5.945	70,0 2.756	95,0 3.740	56,0 2.205	25,0 0.984	35,0 1.378	SPGX0703	SCGX060204	0,5 0.020	0,36 0.014
SD523-22-66-25R7	03080605	22,0 0.866	66,0 2.598	152,0 5.984	71,0 2.795	96,0 3.780	56,0 2.205	25,0 0.984	35,0 1.378	SPGX0703	SCGX060204	0,44 0.017	0,46 0.018
SD523-22.5-68-25R7	03080602	22,5 0.886	68,0 2.677	154,0 6.063	73,0 2.874	98,0 3.858	56,0 2.205	25,0 0.984	35,0 1.378	SPGX0703	SCGX070308	0,42 0.017	0,47 0.019
SD523-23-69-25R7	03080608	23,0 0.906	69,0 2.717	155,0 6.102	74,0 2.913	99,0 3.898	56,0 2.205	25,0 0.984	35,0 1.378	SPGX0703	SCGX070308	0,33 0.013	0,5 0.020
SD523-23.5-71-25R7	03080607	23,5 0.925	71,0 2.795	157,0 6.181	76,0 2.992	101,0 3.976	56,0 2.205	25,0 0.984	35,0 1.378	SPGX0703	SCGX070308	0,23 0.009	0,5 0.020
SD523-24-72-25R7	03080612	24,0 0.945	72,0 2.835	158,0 6.220	77,0 3.031	102,0 4.016	56,0 2.205	25,0 0.984	35,0 1.378	SPGX0703	SCGX070308	0,11 0.004	0,5 0.020
SD523-24.5-74-25R7	03080611	24,5 0.965	74,0 2.913	160,0 6.299	79,0 3.110	104,0 4.094	56,0 2.205	25,0 0.984	35,0 1.378	SPGX0703	SCGX070308	0,11 0.004	0,5 0.020
SD523-25-75-32R7	03080616	25,0 0.984	75,0 2.953	165,0 6.496	80,0 3.150	105,0 4.134	60,0 2.362	32,0 1.260	42,0 1.654	SPGX0703	SCGX070308	0,11 0.004	0,5 0.020
SD523-25.5-77-32R7	03080615	25,5 1.004	77,0 3.031	167,0 6.575	82,0 3.228	107,0 4.213	60,0 2.362	32,0 1.260	42,0 1.654	SPGX0903	SCGX070308	0,5 0.020	0,11 0.004
SD523-26-78-32R7	03080619	26,0 1.024	78,0 3.071	168,0 6.614	83,0 3.268	108,0 4.252	60,0 2.362	32,0 1.260	42,0 1.654	SPGX0903	SCGX070308	0,5 0.020	0,11 0.004
SD523-26.5-80-32R7	03080618	26,5 1.043	80,0 3.150	170,0 6.693	85,0 3.346	110,0 4.331	60,0 2.362	32,0 1.260	42,0 1.654	SPGX0903	SCGX070308	0,5 0.020	0,19 0.007
SD523-27-81-32R7	03080622	27,0 1.063	81,0 3.189	171,0 6.732	86,0 3.386	111,0 4.370	60,0 2.362	32,0 1.260	42,0 1.654	SPGX0903	SCGX070308	0,5 0.020	0,26 0.010
SD523-27.5-83-32R7	03080621	27,5 1.083	83,0 3.268	173,0 6.811	88,0 3.465	113,0 4.449	60,0 2.362	32,0 1.260	42,0 1.654	SPGX0903	SCGX070308	0,46 0.018	0,44 0.017
SD523-28-84-32R7	03080626	28,0 1.102	84,0 3.307	174,0 6.850	89,0 3.504	114,0 4.488	60,0 2.362	32,0 1.260	42,0 1.654	SPGX0903	SCGX070308	0,28 0.011	0,5 0.020
SD523-28.5-86-32R7	03080624	28,5 1.122	86,0 3.386	176,0 6.929	91,0 3.583	116,0 4.567	60,0 2.362	32,0 1.260	42,0 1.654	SPGX0903	SCGX09T308	0,21 0.008	0,5 0.020
SD523-29-87-32R7	03080629	29,0 1.142	87,0 3.425	177,0 6.969	92,0 3.622	117,0 4.606	60,0 2.362	32,0 1.260	42,0 1.654	SPGX0903	SCGX09T308	0,18 0.007	0,5 0.020
SD523-29.5-89-32R7	03080628	29,5 1.161	89,0 3.504	179,0 7.047	94,0 3.701	119,0 4.685	60,0 2.362	32,0 1.260	42,0 1.654	SPGX0903	SCGX09T308	0,15 0.006	0,5 0.020
SD523-30-90-32R7	03080632	30,0 1.181	90,0 3.543	180,0 7.087	95,0 3.740	120,0 4.724	60,0 2.362	32,0 1.260	42,0 1.654	SPGX0903	SCGX09T308	0,12 0.005	0,5 0.020
SD523-30.5-92-32R7	03080631	30,5 1.201	92,0 3.622	182,0 7.165	97,0 3.819	122,0 4.803	60,0 2.362	32,0 1.260	42,0 1.654	SPGX0903	SCGX09T308	0,12 0.005	0,5 0.020
SD523-31-93-32R7	03080636	31,0 1.220	93,0 3.661	183,0 7.205	98,0 3.858	123,0 4.843	60,0 2.362	32,0 1.260	42,0 1.654	SPGX0903	SCGX09T308	0,12 0.005	0,5 0.020
SD523-31.5-95-32R7	03080634	31,5 1.240	95,0 3.740	185,0 7.283	100,0 3.937	125,0 4.921	60,0 2.362	32,0 1.260	42,0 1.654	SPGX11T3	SCGX09T308	0,5 0.020	0,24 0.009
SD523-32-96-32R7	03080638	32,0 1.260	96,0 3.780	186,0 7.323	101,0 3.976	126,0 4.961	60,0 2.362	32,0 1.260	42,0 1.654	SPGX11T3	SCGX09T308	0,5 0.020	0,31 0.012
SD523-32-96-40R7	03080639	32,0 1.260	96,0 3.780	194,0 7.638	101,0 3.976	126,0 4.961	68,0 2.677	40,0 1.575	50,0 1.969	SPGX11T3	SCGX09T308	0,5 0.020	0,31 0.012
SD523-33-99-32R7	03080641	33,0 1.299	99,0 3.898	189,0 7.441	104,0 4.094	129,0 5.079	60,0 2.362	32,0 1.260	42,0 1.654	SPGX11T3	SCGX09T308	0,5 0.020	0,46 0.018
SD523-33-99-40R7	03080642	33,0 1.299	99,0 3.898	197,0 7.756	104,0 4.094	129,0 5.079	68,0 2.677	40,0 1.575	50,0 1.969	SPGX11T3	SCGX09T308	0,5 0.020	0,46 0.018
SD523-34-102-32R7	03080644	34,0 1.339	102,0 4.016	192,0 7.559	107,0 4.213	132,0 5.197	60,0 2.362	32,0 1.260	42,0 1.654	SPGX11T3	SCGX09T308	0,22 0.009	0,5 0.020
SD523-34-102-40R7	03080645	34,0 1.339	102,0 4.016	200,0 7.874	107,0 4.213	132,0 5.197	68,0 2.677	40,0 1.575	50,0 1.969	SPGX11T3	SCGX09T308	0,22 0.009	0,5 0.020
SD523-35-105-32R7	03080648	35,0 1.378	105,0 4.134	195,0 7.677	110,0 4.331	135,0 5.315	60,0 2.362	32,0 1.260	42,0 1.654	SPGX11T3	SCGX11T308	0,22 0.009	0,5 0.020
SD523-35-105-40R7	03080649	35,0 1.378	105,0 4.134	203,0 7.992	110,0 4.331	135,0 5.315	68,0 2.677	40,0 1.575	50,0 1.969	SPGX11T3	SCGX11T308	0,22 0.009	0,5 0.020
SD523-35.5-107-40R7	03080647	35,5 1.398	107,0 4.213	205,0 8.071	112,0 4.409	137,0 5.394	68,0 2.677	40,0 1.575	50,0 1.969	SPGX11T3	SCGX11T308	0,09 0.004	0,5 0.020

Wstęp

Wiercenie

Rozwiercanie

Wylaczanie

Załącznik

Oznaczenie	Numer produktu	DC	LU	OAL	LUX	LFS	LS	DMM	DF	Płytki		Regulacja promieniowa	
		mm Cal.	mm Cal.	mm Cal.	mm Cal.	mm Cal.	mm Cal.	mm Cal.	mm Cal.	Płytki centralna	Płytki pereryferyjna	mm - Cal. -	mm + Cal. +
SD523-36-108-32R7	03080651	36,0 1.417	108,0 4.252	198,0 7.795	113,0 4.449	138,0 5.433	60,0 2.362	32,0 1.260	42,0 1.654	SPGX11T3	SCGX11T308	0,09 0.004	0,5 0.020
SD523-36-108-40R7	03080652	36,0 1.417	108,0 4.252	206,0 8.110	113,0 4.449	138,0 5.433	68,0 2.677	40,0 1.575	50,0 1.969	SPGX11T3	SCGX11T308	0,09 0.004	0,5 0.020
SD523-37-111-32R7	03080653	37,0 1.457	111,0 4.370	201,0 7.913	116,0 4.567	141,0 5.551	60,0 2.362	32,0 1.260	42,0 1.654	SPGX11T3	SCGX11T308	0,09 0.004	0,5 0.020
SD523-37-111-40R7	03080654	37,0 1.457	111,0 4.370	209,0 8.228	116,0 4.567	141,0 5.551	68,0 2.677	40,0 1.575	50,0 1.969	SPGX11T3	SCGX11T308	0,09 0.004	0,5 0.020
SD523-38-114-32R7	03080655	38,0 1.496	114,0 4.488	204,0 8.031	119,0 4.685	144,0 5.669	60,0 2.362	32,0 1.260	42,0 1.654	SPGX12T3	SCGX11T308	0,5 0.020	0,5 0.020
SD523-38-114-40R7	03080656	38,0 1.496	114,0 4.488	212,0 8.346	119,0 4.685	144,0 5.669	68,0 2.677	40,0 1.575	50,0 1.969	SPGX12T3	SCGX11T308	0,5 0.020	0,5 0.020
SD523-39-117-32R7	03080658	39,0 1.535	117,0 4.606	207,0 8.150	122,0 4.803	147,0 5.787	60,0 2.362	32,0 1.260	42,0 1.654	SPGX12T3	SCGX11T308	0,39 0.015	0,5 0.020
SD523-39-117-40R7	03080659	39,0 1.535	117,0 4.606	215,0 8.465	122,0 4.803	147,0 5.787	68,0 2.677	40,0 1.575	50,0 1.969	SPGX12T3	SCGX11T308	0,39 0.015	0,5 0.020
SD523-40-120-32R7	03080661	40,0 1.575	120,0 4.724	210,0 8.268	125,0 4.921	150,0 5.906	60,0 2.362	32,0 1.260	50,0 1.969	SPGX12T3	SCGX11T308	0,19 0.007	0,5 0.020
SD523-40-120-40R7	03080662	40,0 1.575	120,0 4.724	218,0 8.583	125,0 4.921	150,0 5.906	68,0 2.677	40,0 1.575	50,0 1.969	SPGX12T3	SCGX11T308	0,19 0.007	0,5 0.020
SD523-41-123-40R7	03080665	41,0 1.614	123,0 4.843	221,0 8.701	128,0 5.039	153,0 6.024	68,0 2.677	40,0 1.575	50,0 1.969	SPGX12T3	SCGX120408	0,19 0.007	0,5 0.020
SD523-41.5-125-40R7	03080663	41,5 1.634	125,0 4.921	223,0 8.780	130,0 5.118	155,0 6.102	68,0 2.677	40,0 1.575	50,0 1.969	SPGX12T3	SCGX120408	0,19 0.007	0,5 0.020
SD523-42-126-40R7	03080666	42,0 1.654	126,0 4.961	224,0 8.819	131,0 5.157	156,0 6.142	68,0 2.677	40,0 1.575	50,0 1.969	SPGX12T3	SCGX120408	0,19 0.007	0,5 0.020
SD523-43-129-40R7	03080667	43,0 1.693	129,0 5.079	227,0 8.937	134,0 5.276	159,0 6.260	68,0 2.677	40,0 1.575	50,0 1.969	SPGX12T3	SCGX120408	0,05 0.002	0,5 0.020
SD523-44-132-40R7	03080670	44,0 1.732	132,0 5.197	230,0 9.055	137,0 5.394	162,0 6.378	68,0 2.677	40,0 1.575	50,0 1.969	SPGX1504	SCGX120408	0,5 0.020	0,41 0.016
SD523-44.5-134-40R7	03080669	44,5 1.752	134,0 5.276	232,0 9.134	139,0 5.472	164,0 6.457	68,0 2.677	40,0 1.575	50,0 1.969	SPGX1504	SCGX150512	0,5 0.020	0,41 0.016
SD523-45-135-40R7	03080672	45,0 1.772	135,0 5.315	233,0 9.173	140,0 5.512	165,0 6.496	68,0 2.677	40,0 1.575	50,0 1.969	SPGX1504	SCGX150512	0,5 0.020	0,41 0.016
SD523-46-138-40R7	03080673	46,0 1.811	138,0 5.433	236,0 9.291	143,0 5.630	168,0 6.614	68,0 2.677	40,0 1.575	50,0 1.969	SPGX1504	SCGX150512	0,5 0.020	0,5 0.020
SD523-47-141-40R7	03080675	47,0 1.850	141,0 5.551	239,0 9.409	146,0 5.748	171,0 6.732	68,0 2.677	40,0 1.575	50,0 1.969	SPGX1504	SCGX150512	0,5 0.020	0,5 0.020
SD523-47.5-143-40R7	03080674	47,5 1.870	143,0 5.630	241,0 9.488	148,0 5.827	173,0 6.811	68,0 2.677	40,0 1.575	50,0 1.969	SPGX1504	SCGX150512	0,5 0.020	0,5 0.020
SD523-48-144-40R7	03080676	48,0 1.890	144,0 5.669	242,0 9.528	149,0 5.866	174,0 6.850	68,0 2.677	40,0 1.575	59,35 2.337	SPGX1504	SCGX150512	0,45 0.018	0,5 0.020
SD523-49-147-40R7	03080677	49,0 1.929	147,0 5.787	245,0 9.646	152,0 5.984	177,0 6.969	68,0 2.677	40,0 1.575	59,35 2.337	SPGX1504	SCGX150512	0,2 0.008	0,5 0.020
SD523-50-150-40R7	03080678	50,0 1.969	150,0 5.906	248,0 9.764	155,0 6.102	180,0 7.087	68,0 2.677	40,0 1.575	59,35 2.337	SPGX1504	SCGX150512	0,2 0.008	0,5 0.020
SD523-51-153-40R7	03080679	51,0 2.008	153,0 6.024	251,0 9.882	158,0 6.220	183,0 7.205	68,0 2.677	40,0 1.575	59,35 2.337	SPGX1504	SCGX150512	0,2 0.008	0,5 0.020
SD523-52-156-40R7	03080680	52,0 2.047	156,0 6.142	254,0 10.000	161,0 6.339	186,0 7.323	68,0 2.677	40,0 1.575	59,35 2.337	SPGX1904	SCGX150512	0,5 0.020	0,42 0.017
SD523-53-159-40R7	03080681	53,0 2.087	159,0 6.260	257,0 10.118	164,0 6.457	189,0 7.441	68,0 2.677	40,0 1.575	59,35 2.337	SPGX1904	SCGX150512	0,5 0.020	0,42 0.017
SD523-54-162-40R7	03080682	54,0 2.126	162,0 6.378	260,0 10.236	167,0 6.575	192,0 7.559	68,0 2.677	40,0 1.575	59,35 2.337	SPGX1904	SCGX150512	0,5 0.020	0,5 0.020
SD523-55-165-40R7	03080683	55,0 2.165	165,0 6.496	263,0 10.354	170,0 6.693	195,0 7.677	68,0 2.677	40,0 1.575	59,35 2.337	SPGX1904	SCGX150512	0,5 0.020	0,5 0.020
SD523-56-168-40R7	03080684	56,0 2.205	168,0 6.614	266,0 10.472	173,0 6.811	198,0 7.795	68,0 2.677	40,0 1.575	59,35 2.337	SPGX1904	SCGX150512	0,5 0.020	0,5 0.020
SD523-57-171-40R7	03080685	57,0 2.244	171,0 6.732	269,0 10.591	176,0 6.929	201,0 7.913	68,0 2.677	40,0 1.575	59,35 2.337	SPGX1904	SCGX150512	0,39 0.015	0,5 0.020

Wstęp

Wiercenie



Rozwiercanie

Wytaczanie



Załącznik

Oznaczenie	Numer produktu	DC	LU	OAL	LUX	LFS	LS	DMM	DF	Płytki		Regulacja promieniowa	
		mm Cal.	mm Cal.	mm Cal.	mm Cal.	mm Cal.	mm Cal.	mm Cal.	mm Cal.	mm Cal.	Płytki centralna	Płytki peryferyjna	mm - Cal. -
SD523-58-174-40R7	03080686	58,0 2.283	174,0 6.850	272,0 10.709	179,0 7.047	204,0 8.031	68,0 2.677	40,0 1.575	63,0 2.480	SPGX1904	SCGX150512	0,09 0.004	0,5 0.020
SD523-59-177-40R7	03080687	59,0 2.323	177,0 6.969	275,0 10.827	182,0 7.165	207,0 8.150	68,0 2.677	40,0 1.575	63,0 2.480	SPGX1904	SCGX150512	0,09 0.004	0,5 0.020

Części zamienne, zawarte w dostawie

Dla śred. wiertła (mm)	Śruba mocująca płytkę		Klucz do płytek
			
	Płytki centralna	Płytki zewn.	
15,00-17,45	C02245-T07P	C02245-T07P	T07P-2
17,46-19,49	C02205-T07P	C02245-T07P	T07P-2
19,50-21,24	C02205-T07P	C02205-T07P	T07P-2
21,25-22,49	C02506-T08P	C02506-T08P	T08P-2
22,50-25,49	C02507-T08P	C03007-T08P	T08P-2
25,50-28,49	C03007-T09P	C03007-T09P	T09P-2
28,50-31,49	C03007-T09P	C03009-T09P	T09P-2
31,50-40,49	C03508-T15P	C03508-T15P	T15P-2D
40,50-43,24	C03508-T15P	C05012-T15P	T15P-2D
43,25-59,00	C04011-T15P	C05012-T15P	T15P-2D

Akcesoria

Dla śred. wiertła (mm)	Klucz dynamometryczny*	Wkładka wymienna	Wielk. mom.
			
15,00-17,45	T00-07P09	T00-07P	0,9 Nm
17,46-19,49	T00-07P09	T00-07P	0,9 Nm
19,50-21,24	T00-07P09	T00-07P	0,9 Nm
21,25-22,49	T00-08P12	T00-08P	1,2 Nm
22,50-25,49	T00-08P12	T00-08P	1,2 Nm
25,50-28,49	T00-09P20	T00-09P	2,0 Nm
28,50-31,49	T00-09P20	T00-09P	2,0 Nm
31,50-40,49	T00-15P30	T00-15P	3,0 Nm
40,50-43,24	T00-15P30	T00-15P	3,0 Nm
43,25-59,00	T00-15P30	T00-15P	3,0 Nm

*Zawiera płytkę.

SD523

Głębokość wiercenia ~ 3 x D – Calowe

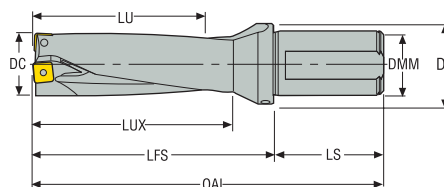

- Chwył ISO 9766, -7
- Chłodzenie wewnętrzne
- Informacja na temat płytek patrz str. 292-298
- Parametry skrawania, patrz strona (strony) 301-302
- Średnice pośrednie patrz aplikacja MyDesign.

Oznaczenie	Numer produktu	DC	LU	OAL	LUX	LFS	LS	DMM	DF	Płytki		Regulacja promieniowa	
										Płytki centralna	Płytki peryferyjna	Cal. -	Cal. +
SD523-0562-169-1000R7	03080485	0.562	1.686	5.117	1.883	2.867	2.250	1.000	1.378	SPGX0502	SCGX050204	0.011	0.009
SD523-0594-178-1000R7	03080486	0.594	1.780	5.211	1.977	2.961	2.250	1.000	1.378	SPGX0502	SCGX050204	0.008	0.013
SD523-0625-188-1000R7	03080488	0.625	1.880	5.311	2.077	3.061	2.250	1.000	1.378	SPGX0502	SCGX050204	0.005	0.015
SD523-0656-197-1000R7	03080490	0.656	1.970	5.401	2.167	3.151	2.250	1.000	1.378	SPGX0502	SCGX050204	0.002	0.019
SD523-0687-206-1000R7	03080493	0.687	2.030	5.461	2.227	3.211	2.250	1.000	1.378	SPGX0502	SCGX050204	0	0.020
SD523-0709-213-1000R7	03080494	0.709	2.130	5.561	2.327	3.311	2.250	1.000	1.378	SPGX0602	SCGX050204	0.013	0.008
SD523-0750-225-1000R7	03080497	0.750	2.250	5.681	2.447	3.431	2.250	1.000	1.378	SPGX0602	SCGX050204	0.004	0.017
SD523-0766-230-1000R7	03080499	0.766	2.300	5.731	2.497	3.481	2.250	1.000	1.378	SPGX0602	SCGX050204	0.001	0.020
SD523-0787-236-1000R7	03080501	0.787	2.360	5.791	2.557	3.541	2.250	1.000	1.378	SPGX0602	SCGX060204	0.003	0.018
SD523-0812-244-1000R7	03080503	0.812	2.440	5.871	2.637	3.621	2.250	1.000	1.378	SPGX0602	SCGX060204	0.001	0.020
SD523-0827-248-1000R7	03080505	0.827	2.480	5.911	2.677	3.661	2.250	1.000	1.378	SPGX0602	SCGX060204	0	0.020
SD523-0875-263-1000R7	03080507	0.875	2.630	6.061	2.827	3.811	2.250	1.000	1.378	SPGX0703	SCGX060204	0.015	0.020
SD523-0906-272-1000R7	03080509	0.906	2.720	6.151	2.917	3.901	2.250	1.000	1.378	SPGX0703	SCGX070308	0.013	0.020
SD523-0922-276-1000R7	03080512	0.922	2.760	6.191	2.957	3.941	2.250	1.000	1.378	SPGX0703	SCGX070308	0.010	0.020
SD523-0937-281-1000R7	03080514	0.937	2.810	6.241	3.007	3.991	2.250	1.000	1.378	SPGX0703	SCGX070308	0.004	0.020
SD523-0984-295-1250R7	03080516	0.984	2.950	6.506	3.147	4.131	2.375	1.250	1.654	SPGX0703	SCGX070308	0.004	0.020
SD523-1000-300-1250R7	03080518	1.000	3.000	6.556	3.197	4.181	2.375	1.250	1.654	SPGX0703	SCGX070308	0.004	0.020
SD523-1032-310-1250R7	03080521	1.032	3.100	6.656	3.297	4.281	2.375	1.250	1.654	SPGX0903	SCGX070308	0.020	0.004
SD523-1062-319-1250R7	03080522	1.062	3.190	6.746	3.387	4.371	2.375	1.250	1.654	SPGX0903	SCGX070308	0.020	0.010
SD523-1109-332-1250R7	03080525	1.109	3.320	6.876	3.517	4.501	2.375	1.250	1.654	SPGX0903	SCGX070308	0.009	0.020
SD523-1125-338-1250R7	03080526	1.125	3.380	6.936	3.577	4.561	2.375	1.250	1.654	SPGX0903	SCGX09T308	0.008	0.020
SD523-1172-351-1250R7	03080528	1.172	3.510	7.066	3.707	4.691	2.375	1.250	1.654	SPGX0903	SCGX09T308	0.005	0.020
SD523-1187-356-1250R7	03080530	1.187	3.560	7.116	3.757	4.741	2.375	1.250	1.654	SPGX0903	SCGX09T308	0.005	0.020
SD523-1250-375-1500R7	03080533	1.250	3.750	7.556	3.947	4.931	2.625	1.500	1.969	SPGX11T3	SCGX09T308	0.020	0.011
SD523-1312-394-1500R7	03080535	1.312	3.940	7.746	4.137	5.121	2.625	1.500	1.969	SPGX11T3	SCGX09T308	0.020	0.020
SD523-1344-403-1500R7	03080537	1.344	4.030	7.836	4.227	5.211	2.625	1.500	1.969	SPGX11T3	SCGX09T308	0.006	0.020
SD523-1375-413-1500R7	03080539	1.375	4.130	7.936	4.327	5.311	2.625	1.500	1.969	SPGX11T3	SCGX11T308	0.009	0.020
SD523-1422-426-1500R7	03080541	1.422	4.260	8.066	4.457	5.441	2.625	1.500	1.969	SPGX11T3	SCGX11T308	0.004	0.020
SD523-1437-431-1500R7	03080542	1.437	4.310	8.116	4.507	5.491	2.625	1.500	1.969	SPGX11T3	SCGX11T308	0.004	0.020
SD523-1500-450-1500R7	03080547	1.500	4.500	8.306	4.697	5.681	2.625	1.500	1.969	SPGX12T3	SCGX11T308	0.020	0.020
SD523-1562-469-1500R7	03080550	1.562	4.690	8.496	4.887	5.871	2.625	1.500	1.969	SPGX12T3	SCGX11T308	0.010	0.020
SD523-1625-488-1500R7	03080555	1.625	4.880	8.686	5.077	6.061	2.625	1.500	1.969	SPGX12T3	SCGX120408	0.007	0.020
SD523-1687-506-1500R7	03080560	1.687	5.060	8.866	5.257	6.241	2.625	1.500	1.969	SPGX12T3	SCGX120408	0.004	0.020
SD523-1750-525-1500R7	03080565	1.750	5.250	9.056	5.447	6.431	2.625	1.500	1.969	SPGX1504	SCGX120408	0.020	0.016
SD523-1812-544-1500R7	03080572	1.812	5.440	9.246	5.637	6.621	2.625	1.500	1.969	SPGX1504	SCGX150512	0.020	0.020
SD523-1875-563-1500R7	03080577	1.875	5.630	9.436	5.827	6.811	2.625	1.500	1.969	SPGX1504	SCGX150512	0.020	0.020

Oznaczenie	Numer produktu	DC	LU	OAL	LUX	LFS	LS	DMM	DF	Płytki		Regulacja promieniowa	
		Cal.	Cal.	Cal.	Cal.	Cal.	Cal.	Cal.	Cal.	Płytki centralna	Płytki peryferyjna	Cal. -	Cal. +
SD523-1937-581-1500R7	03080581	1.937	5.810	9.616	6.007	6.991	2.625	1.500	2.337	SPGX1504	SCGX150512	0.008	0.020
SD523-2000-600-1500R7	03080588	2.000	6.000	9.806	6.197	7.181	2.625	1.500	2.337	SPGX1504	SCGX150512	0.008	0.020
SD523-2062-619-1500R7	03080593	2.062	6.190	9.996	6.387	7.371	2.625	1.500	2.337	SPGX1904	SCGX150512	0.020	0.017
SD523-2125-638-1500R7	03080596	2.125	6.380	10.186	6.577	7.561	2.625	1.500	2.337	SPGX1904	SCGX150512	0.020	0.020
SD523-2250-675-1500R7	03080603	2.250	6.750	10.556	6.947	7.931	2.625	1.500	2.337	SPGX1904	SCGX150512	0.013	0.020
SD523-2375-713-1500R7	03080609	2.375	7.130	10.936	7.327	8.311	2.625	1.500	2.480	SPGX1904	SCGX150512	0.004	0.020

Części zamienne, zawarte w dostawie

Dla śred. wiertła (cale)	Śruba do płytki centralnej	Śruba do płytki zewnętrznej	Klucz
0.562-0.687	C02245-T07P	C02245-T07P	T07P-2
0.709-0.766	C02205-T07P	C02245-T07P	T07P-2
0.787-0.827	C02205-T07P	C02205-T07P	T07P-2
0.875	C02506-T08P	C02506-T08P	T08P-2
0.906	C02507-T08P	C03007-T08P	T08P-2
0.922	C02506-T08P	C03007-T08P	T08P-2
0.937-1.000	C02507-T08P	C03007-T08P	T08P-2
1.032-1.109	C03007-T09P	C03007-T09P	T09P-2
1.125-1.187	C03007-T09P	C03009-T09P	T09P-2
1.250-1.562	C03508-T15P	C03508-T15P	T15P-2D
1.625-1.687	C03508-T15P	C05012-T15P	T15P-2D
1.750-2.375	C04011-T15P	C05012-T15P	T15P-2D

Akcesoria

Dla śred. wiertła (cale)	Wkładka do wymiany	Klucz dynamometryczny
0.562-0.687	T00-07P	T00-07P09
0.709-0.766	-	T00-07P09
0.787-0.827	-	T00-07P09
0.875	-	T00-08P12
0.906	-	T00-08P12
0.922	-	T00-08P12
0.937-1.000	-	T00-08P12
1.032-1.109	-	T00-09P20
1.125-1.187	-	T00-09P20
1.250-1.562	-	T00-15P30
1.625-1.687	-	T00-15P30
1.750-2.375	-	T00-15P35

SD523

Głębokość wiercenia ~ 3 x D – Calowe

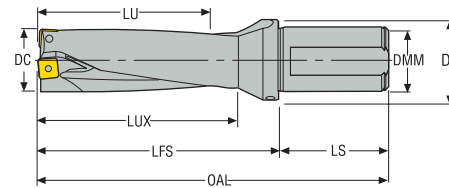





- Chwyłt ISO 9766, R7-C
- Chłodzenie wewnętrzne
- Informacja na temat płytek patrz str. 292-298
- Parametry skrawania, patrz strona (strony) 301-302
- Średnice pośrednie patrz aplikacja MyDesign.
- Do zastosowań stacjonarnych

Oznaczenie	Numer produktu	DC	LU	OAL	LUX	LFS	LS	DMM	DF	Płytki		Regulacja promieniowa	
										Płytki centralna	Płytki peryferyjna	Cal. -	Cal. +
SD523-0594-178-1000R7-C	03080487	0.594	1.780	5.908	1.977	3.158	2.750	1.000	1.378	SPGX0502	SCGX050204	0.008	0.013
SD523-0625-188-1000R7-C	03080489	0.625	1.880	6.008	2.077	3.258	2.750	1.000	1.378	SPGX0502	SCGX050204	0.005	0.015
SD523-0656-197-1000R7-C	03080491	0.656	1.970	6.098	2.167	3.348	2.750	1.000	1.378	SPGX0502	SCGX050204	0.002	0.019
SD523-0687-206-1000R7-C	03080492	0.687	2.060	6.188	2.257	3.438	2.750	1.000	1.378	SPGX0502	SCGX050204	0	0.020
SD523-0709-213-1000R7-C	03080495	0.709	2.130	6.258	2.327	3.508	2.750	1.000	1.378	SPGX0602	SCGX050204	0.013	0.008
SD523-0750-225-1000R7-C	03080496	0.750	2.250	6.378	2.447	3.628	2.750	1.000	1.378	SPGX0602	SCGX050204	0.004	0.017
SD523-0766-230-1000R7-C	03080500	0.766	2.300	6.428	2.497	3.678	2.750	1.000	1.378	SPGX0602	SCGX050204	0.001	0.020
SD523-0787-236-1000R7-C	03080502	0.787	2.360	6.488	2.557	3.738	2.750	1.000	1.378	SPGX0602	SCGX060204	0.003	0.018
SD523-0812-244-1000R7-C	03080504	0.812	2.440	6.568	2.637	3.818	2.750	1.000	1.378	SPGX0602	SCGX060204	0.001	0.020
SD523-0827-248-1000R7-C	03080506	0.827	2.480	6.608	2.677	3.858	2.750	1.000	1.378	SPGX0602	SCGX060204	0	0.020
SD523-0875-263-1000R7-C	03080508	0.875	2.630	6.758	2.827	4.008	2.750	1.000	1.378	SPGX0703	SCGX060204	0.015	0.020
SD523-0906-272-1000R7-C	03080511	0.906	2.720	6.848	2.917	4.098	2.750	1.000	1.378	SPGX0703	SCGX070308	0.013	0.020
SD523-0922-276-1000R7-C	03080513	0.922	2.760	6.888	2.957	4.138	2.750	1.000	1.378	SPGX0703	SCGX070308	0.010	0.020
SD523-0937-281-1000R7-C	03080515	0.937	2.810	6.938	3.007	4.188	2.750	1.000	1.378	SPGX0703	SCGX070308	0.004	0.020
SD523-0984-295-1250R7-C	03080517	0.984	2.950	7.078	3.147	4.328	2.750	1.250	1.654	SPGX0703	SCGX070308	0.004	0.020
SD523-1000-300-1250R7-C	03080519	1.000	3.000	7.128	3.197	4.378	2.750	1.250	1.654	SPGX0703	SCGX070308	0.004	0.020
SD523-1032-310-1250R7-C	03080520	1.032	3.100	7.228	3.297	4.478	2.750	1.250	1.654	SPGX0903	SCGX070308	0.020	0.004
SD523-1062-319-1250R7-C	03080523	1.062	3.190	7.318	3.387	4.568	2.750	1.250	1.654	SPGX0903	SCGX070308	0.020	0.010
SD523-1109-332-1250R7-C	03080524	1.109	3.320	7.448	3.517	4.698	2.750	1.250	1.654	SPGX0903	SCGX070308	0.009	0.020
SD523-1125-338-1250R7-C	03080527	1.125	3.380	7.508	3.577	4.758	2.750	1.250	1.654	SPGX0903	SCGX09T308	0.008	0.020
SD523-1172-351-1250R7-C	03080529	1.172	3.510	7.638	3.707	4.888	2.750	1.250	1.654	SPGX0903	SCGX09T308	0.005	0.020
SD523-1187-356-1250R7-C	03080531	1.187	3.560	7.688	3.757	4.938	2.750	1.250	1.654	SPGX0903	SCGX09T308	0.005	0.020
SD523-1250-375-1500R7-C	03080532	1.250	3.750	7.878	3.947	5.128	2.750	1.500	1.969	SPGX11T3	SCGX09T308	0.020	0.011
SD523-1312-394-1500R7-C	03080536	1.312	3.940	8.068	4.137	5.318	2.750	1.500	1.969	SPGX11T3	SCGX09T308	0.020	0.020
SD523-1344-403-1500R7-C	03080538	1.344	4.030	8.158	4.227	5.408	2.750	1.500	1.969	SPGX11T3	SCGX09T308	0.006	0.020
SD523-1375-413-1500R7-C	03080540	1.375	4.130	8.258	4.327	5.508	2.750	1.500	1.969	SPGX11T3	SCGX11T308	0.009	0.020
SD523-1422-426-1500R7-C	03080900	1.422	4.260	8.388	4.457	5.638	2.750	1.500	1.969	SPGX11T3	SCGX11T308	0.004	0.020
SD523-1437-431-1500R7-C	03080543	1.437	4.310	8.438	4.507	5.688	2.750	1.500	1.969	SPGX11T3	SCGX11T308	0.004	0.020
SD523-1500-450-1500R7-C	03080546	1.500	4.500	8.628	4.697	5.878	2.750	1.500	1.969	SPGX12T3	SCGX11T308	0.020	0.020
SD523-1562-469-1500R7-C	03080551	1.562	4.690	8.818	4.887	6.068	2.750	1.500	1.969	SPGX12T3	SCGX11T308	0.010	0.020
SD523-1625-488-1500R7-C	03080556	1.625	4.880	9.008	5.077	6.258	2.750	1.500	1.969	SPGX12T3	SCGX120408	0.007	0.020
SD523-1687-506-1500R7-C	03080561	1.687	5.060	9.188	5.257	6.438	2.750	1.500	1.969	SPGX12T3	SCGX120408	0.004	0.020
SD523-1750-525-1500R7-C	03080566	1.750	5.250	9.378	5.447	6.628	2.750	1.500	1.969	SPGX1504	SCGX120408	0.020	0.016
SD523-1812-544-1500R7-C	03080573	1.812	5.440	9.568	5.637	6.818	2.750	1.500	1.969	SPGX1504	SCGX150512	0.020	0.020
SD523-1875-563-1500R7-C	03080578	1.875	5.630	9.758	5.827	7.008	2.750	1.500	1.969	SPGX1504	SCGX150512	0.020	0.020

Oznaczenie	Numer produktu	DC	LU	OAL	LUX	LFS	LS	DMM	DF	Płytki		Regulacja promieniowa	
		Cal.	Cal.	Cal.	Cal.	Cal.	Cal.	Cal.	Cal.	Płytki centralna	Płytki peryferyjna	Cal. -	Cal. +
SD523-1937-581-1500R7-C	03080582	1.937	5.810	9.938	6.007	7.188	2.750	1.500	2.337	SPGX1504	SCGX150512	0.008	0.020
SD523-2000-600-1500R7-C	03080589	2.000	6.000	10.128	6.197	7.378	2.750	1.500	2.337	SPGX1504	SCGX150512	0.008	0.020
SD523-2125-638-1500R7-C	03080598	2.125	6.380	10.508	6.577	7.758	2.750	1.500	2.337	SPGX1904	SCGX150512	0.020	0.020
SD523-2250-675-1500R7-C	03080604	2.250	6.750	10.878	6.947	8.128	2.750	1.500	2.337	SPGX1904	SCGX150512	0.013	0.020
SD523-2375-713-1500R7-C	03080610	2.375	7.130	11.258	7.327	8.508	2.750	1.500	2.480	SPGX1904	SCGX150512	0.004	0.020

Części zamienne, zawarte w dostawie

Dla śred. wiertła (cale)	Adapter przewodu	Śruba do płytki centralnej	Śruba do płytki zewnętrznej	Klucz	Zaślepka
0.594-0.687	 1310	 C02245-T07P	 C02245-T07P	 T07P-2	 R1/4
0.709-0.766	1310	C02205-T07P	C02245-T07P	T07P-2	R1/4
0.787-0.827	1310	C02205-T07P	C02205-T07P	T07P-2	R1/4
0.875	1310	C02506-T08P	C02506-T08P	T08P-2	R1/4
0.906-0.922	1310	C02506-T08P	C03007-T08P	T08P-2	R1/4
0.937-1.000	1310	C02507-T08P	C03007-T08P	T08P-2	R1/4
1.032-1.109	1310	C03007-T09P	C03007-T09P	T09P-2	R1/4
1.125-1.187	1310	C03007-T09P	C03009-T09P	T09P-2	R1/4
1.250-1.562	1310	C03508-T15P	C03508-T15P	T15P-2D	R1/4
1.625-1.687	1310	C03508-T15P	C05012-T15P	T15P-2D	R1/4
1.750-2.375	1310	C04011-T15P	C05012-T15P	T15P-2D	R1/4

Akcesoria

Dla śred. wiertła (cale)	Klucz dynamometryczny
	
0.594-0.687	T00-07P09
0.709-0.766	T00-07P09
0.787-0.827	T00-07P09
0.875	T00-08P12
0.906-0.922	T00-08P12
0.937-1.000	T00-08P12
1.032-1.109	T00-09P20
1.125-1.187	T00-09P20
1.250-1.562	T00-15P30
1.625-1.687	T00-15P30
1.750-2.375	T00-15P35

SD523

Głębokość wiercenia ~ 3 x D – Metryczne/Calowe

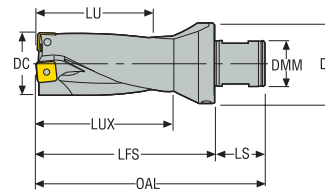



- Chwyt kompatybilny z ABS 50, -2
- Chłodzenie wewnętrzne
- Informacja na temat płytek patrz str. 292-298
- Parametry skrawania, patrz strona (strony) 301-302
- Średnice pośrednie patrz aplikacja MyDesign.

Oznaczenie	Numer produktu	DC	LU	OAL	LUX	LFS	LS	DMM	DF	Płytki		Regulacja promieniowa	
										Płytki centralna	Płytki peryferyjna	mm - Cal. -	mm + Cal. +
SD523-15-45-50R2	03080864	15,0 0.591	45,0 1.772	106,0 4.173	50,0 1.969	75,0 2.953	31,0 1.220	28,0 1.102	50,0 1.969	SPGX0502	SCGX050204	0,22 0.009	0,31 0.012
SD523-15.5-47-50R2	03080865	15,5 0.610	47,0 1.850	108,0 4.252	52,0 2.047	77,0 3.031	31,0 1.220	28,0 1.102	50,0 1.969	SPGX0502	SCGX050204	0,17 0.007	0,36 0.014
SD523-16-48-50R2	03080559	16,0 0.630	48,0 1.890	109,0 4.291	53,0 2.087	78,0 3.071	31,0 1.220	28,0 1.102	50,0 1.969	SPGX0502	SCGX050204	0,12 0.005	0,41 0.016
SD523-16.5-50-50R2	03080866	16,5 0.650	50,0 1.969	111,0 4.370	55,0 2.165	80,0 3.150	31,0 1.220	28,0 1.102	50,0 1.969	SPGX0502	SCGX050204	0,07 0.003	0,46 0.018
SD523-17-51-50R2	03080867	17,0 0.669	51,0 2.008	112,0 4.409	56,0 2.205	81,0 3.189	31,0 1.220	28,0 1.102	50,0 1.969	SPGX0502	SCGX050204	0,02 0.001	0,5 0.020
SD523-17.5-53-50R2	03080564	17,5 0.689	53,0 2.087	114,0 4.488	58,0 2.283	83,0 3.268	31,0 1.220	28,0 1.102	50,0 1.969	SPGX0602	SCGX050204	0,43 0.017	0,1 0.004
SD523-18-54-50R2	03080576	18,0 0.709	54,0 2.126	115,0 4.528	59,0 2.323	84,0 3.307	31,0 1.220	28,0 1.102	50,0 1.969	SPGX0602	SCGX050204	0,32 0.013	0,21 0.008
SD523-18.5-56-50R2	03080868	18,5 0.728	56,0 2.205	117,0 4.606	61,0 2.402	86,0 3.386	31,0 1.220	28,0 1.102	50,0 1.969	SPGX0602	SCGX050204	0,22 0.009	0,31 0.012
SD523-19-57-50R2	03080585	19,0 0.748	57,0 2.244	118,0 4.646	62,0 2.441	87,0 3.425	31,0 1.220	28,0 1.102	50,0 1.969	SPGX0602	SCGX050204	0,11 0.004	0,42 0.017
SD523-20-60-50R2	03080591	20,0 0.787	60,0 2.362	121,0 4.764	65,0 2.559	90,0 3.543	31,0 1.220	28,0 1.102	50,0 1.969	SPGX0602	SCGX060204	0,07 0.003	0,46 0.018
SD523-20.62-62-50R2	03080587	20,62 0.812	62,0 2.441	123,0 4.843	67,0 2.638	92,0 3.622	31,0 1.220	28,0 1.102	50,0 1.969	SPGX0602	SCGX060204	0,03 0.001	0,5 0.020
SD523-21-63-50R2	03080600	21,0 0.827	63,0 2.480	124,0 4.882	68,0 2.677	93,0 3.661	31,0 1.220	28,0 1.102	50,0 1.969	SPGX0602	SCGX060204	0,01 0	0,5 0.020
SD523-22-66-50R2	03080606	22,0 0.866	66,0 2.598	127,0 5.000	71,0 2.795	96,0 3.780	31,0 1.220	28,0 1.102	50,0 1.969	SPGX0703	SCGX060204	0,44 0.017	0,46 0.018
SD523-22.23-67-50R2	03080601	22,23 0.875	67,0 2.638	128,0 5.039	72,0 2.835	97,0 3.819	31,0 1.220	28,0 1.102	50,0 1.969	SPGX0703	SCGX060204	0,39 0.015	0,5 0.020
SD523-23-69-50R2	03080869	23,0 0.906	69,0 2.717	130,0 5.118	74,0 2.913	99,0 3.898	31,0 1.220	28,0 1.102	50,0 1.969	SPGX0703	SCGX070308	0,33 0.013	0,5 0.020
SD523-24-72-50R2	03080613	24,0 0.945	72,0 2.835	133,0 5.236	77,0 3.031	102,0 4.016	31,0 1.220	28,0 1.102	50,0 1.969	SPGX0703	SCGX070308	0,11 0.004	0,5 0.020
SD523-25-75-50R2	03080617	25,0 0.984	75,0 2.953	136,0 5.354	80,0 3.150	105,0 4.134	31,0 1.220	28,0 1.102	50,0 1.969	SPGX0703	SCGX070308	0,11 0.004	0,5 0.020
SD523-25.40-77-50R2	03080614	25,4 1.000	77,0 3.031	138,0 5.433	82,0 3.228	107,0 4.213	31,0 1.220	28,0 1.102	50,0 1.969	SPGX0703	SCGX070308	0,11 0.004	0,5 0.020
SD523-26-78-50R2	03080620	26,0 1.024	78,0 3.071	139,0 5.472	83,0 3.268	108,0 4.252	31,0 1.220	28,0 1.102	50,0 1.969	SPGX0903	SCGX070308	0,5 0.020	0,11 0.004
SD523-27-81-50R2	03080623	27,0 1.063	81,0 3.189	142,0 5.591	86,0 3.386	111,0 4.370	31,0 1.220	28,0 1.102	50,0 1.969	SPGX0903	SCGX070308	0,5 0.020	0,26 0.010
SD523-28-84-50R2	03080627	28,0 1.102	84,0 3.307	145,0 5.709	89,0 3.504	114,0 4.488	31,0 1.220	28,0 1.102	50,0 1.969	SPGX0903	SCGX070308	0,28 0.011	0,5 0.020
SD523-28.59-86-50R2	03080625	28,59 1.126	86,0 3.386	147,0 5.787	91,0 3.583	116,0 4.567	31,0 1.220	28,0 1.102	50,0 1.969	SPGX0903	SCGX09T308	0,21 0.008	0,5 0.020

Oznaczenie	Numer produktu	DC	LU	OAL	LUX	LFS	LS	DMM	DF	Płytki		Regulacja promieniowa	
		mm Cal.	mm Cal.	mm Cal.	mm Cal.	mm Cal.	mm Cal.	mm Cal.	mm Cal.	Płytki centralna	Płytki peryferyjna	mm - Cal. -	mm + Cal. +
SD523-29-87-50R2	03080630	29,0 1.142	87,0 3.425	148,0 5.827	92,0 3.622	117,0 4.606	31,0 1.220	28,0 1.102	50,0 1.969	SPGX0903	SCGX09T308	0,18 0.007	0,5 0.020
SD523-30-90-50R2	03080633	30,0 1.181	90,0 3.543	151,0 5.945	95,0 3.740	120,0 4.724	31,0 1.220	28,0 1.102	50,0 1.969	SPGX0903	SCGX09T308	0,12 0.005	0,5 0.020
SD523-31-93-50R2	03080637	31,0 1.220	93,0 3.661	154,0 6.063	98,0 3.858	123,0 4.843	31,0 1.220	28,0 1.102	50,0 1.969	SPGX0903	SCGX09T308	0,12 0.005	0,5 0.020
SD523-31.75-96-50R2	03080635	31,75 1.250	96,0 3.780	157,0 6.181	101,0 3.976	126,0 4.961	31,0 1.220	28,0 1.102	50,0 1.969	SPGX11T3	SCGX09T308	0,5 0.020	0,28 0.011
SD523-32-96-50R2	03080640	32,0 1.260	96,0 3.780	157,0 6.181	101,0 3.976	126,0 4.961	31,0 1.220	28,0 1.102	50,0 1.969	SPGX11T3	SCGX09T308	0,5 0.020	0,31 0.012
SD523-33-99-50R2	03080643	33,0 1.299	99,0 3.898	160,0 6.299	104,0 4.094	129,0 5.079	31,0 1.220	28,0 1.102	50,0 1.969	SPGX11T3	SCGX09T308	0,5 0.020	0,46 0.018
SD523-34-102-50R2	03080646	34,0 1.339	102,0 4.016	163,0 6.417	107,0 4.213	132,0 5.197	31,0 1.220	28,0 1.102	50,0 1.969	SPGX11T3	SCGX09T308	0,22 0.009	0,5 0.020
SD523-35-105-50R2	03080650	35,0 1.378	105,0 4.134	166,0 6.535	110,0 4.331	135,0 5.315	31,0 1.220	28,0 1.102	50,0 1.969	SPGX11T3	SCGX11T308	0,22 0.009	0,5 0.020
SD523-36-108-50R2	03080870	36,0 1.417	108,0 4.252	169,0 6.654	113,0 4.449	138,0 5.433	31,0 1.220	28,0 1.102	50,0 1.969	SPGX11T3	SCGX11T308	0,09 0.004	0,5 0.020
SD523-37-111-50R2	03080871	37,0 1.457	111,0 4.370	172,0 6.772	116,0 4.567	141,0 5.551	31,0 1.220	28,0 1.102	50,0 1.969	SPGX11T3	SCGX11T308	0,09 0.004	0,5 0.020
SD523-38-114-50R2	03080657	38,0 1.496	114,0 4.488	175,0 6.890	119,0 4.685	144,0 5.669	31,0 1.220	28,0 1.102	50,0 1.969	SPGX12T3	SCGX11T308	0,5 0.020	0,5 0.020
SD523-39-117-50R2	03080660	39,0 1.535	117,0 4.606	178,0 7.008	122,0 4.803	147,0 5.787	31,0 1.220	28,0 1.102	50,0 1.969	SPGX12T3	SCGX11T308	0,39 0.015	0,5 0.020
SD523-40-120-50R2	03080872	40,0 1.575	120,0 4.724	181,0 7.126	125,0 4.921	150,0 5.906	31,0 1.220	28,0 1.102	50,0 1.969	SPGX12T3	SCGX11T308	0,19 0.007	0,5 0.020
SD523-41-123-50R2	03080873	41,0 1.614	123,0 4.843	184,0 7.244	128,0 5.039	153,0 6.024	31,0 1.220	28,0 1.102	50,0 1.969	SPGX12T3	SCGX120408	0,19 0.007	0,5 0.020
SD523-42-126-50R2	03080874	42,0 1.654	126,0 4.961	187,0 7.362	131,0 5.157	156,0 6.142	31,0 1.220	28,0 1.102	50,0 1.969	SPGX12T3	SCGX120408	0,19 0.007	0,5 0.020
SD523-43-129-50R2	03080875	43,0 1.693	129,0 5.079	190,0 7.480	134,0 5.276	159,0 6.260	31,0 1.220	28,0 1.102	50,0 1.969	SPGX12T3	SCGX120408	0,05 0.002	0,5 0.020
SD523-44-132-50R2	03080671	44,0 1.732	132,0 5.197	193,0 7.598	137,0 5.394	162,0 6.378	31,0 1.220	28,0 1.102	50,0 1.969	SPGX1504	SCGX120408	0,5 0.020	0,41 0.016
SD523-44.45-134-50R2	03080668	44,45 1.750	134,0 5.276	195,0 7.677	139,0 5.472	164,0 6.457	31,0 1.220	28,0 1.102	50,0 1.969	SPGX1504	SCGX120408	0,5 0.020	0,41 0.016

Części zamienne, zawarte w dostawie

Dla śred. wiertła (mm)	Śruba mocująca płytkę		Klucz do płytek
			
	Płytki centralna	Płytki zewn.	
15,00-17,45	C02245-T07P	C02245-T07P	T07P-2
17,46-19,49	C02205-T07P	C02245-T07P	T07P-2
19,50-21,24	C02205-T07P	C02205-T07P	T07P-2
21,25-22,49	C02506-T08P	C02506-T08P	T08P-2
22,50-25,49	C02507-T08P	C03007-T08P	T08P-2
25,50-28,49	C03007-T09P	C03007-T09P	T09P-2
28,50-31,49	C03007-T09P	C03009-T09P	T09P-2
31,50-40,49	C03508-T15P	C03508-T15P	T15P-2D
40,50-43,24	C03508-T15P	C05012-T15P	T15P-2D
43,25-59,00	C04011-T15P	C05012-T15P	T15P-2D

Akcesoria

Dla śred. wiertła (mm)	Klucz dynamometryczny*	Wkładka wymienna	Wielk. mom.
15,00-17,45	T00-07P09	T00-07P	0,9 Nm
17,46-19,49	T00-07P09	T00-07P	0,9 Nm
19,50-21,24	T00-07P09	T00-07P	0,9 Nm
21,25-22,49	T00-08P12	T00-08P	1,2 Nm
22,50-25,49	T00-08P12	T00-08P	1,2 Nm
25,50-28,49	T00-09P20	T00-09P	2,0 Nm
28,50-31,49	T00-09P20	T00-09P	2,0 Nm
31,50-40,49	T00-15P30	T00-15P	3,0 Nm
40,50-43,24	T00-15P30	T00-15P	3,0 Nm
43,25-59,00	T00-15P30	T00-15P	3,0 Nm

*Zawiera płytkę.

Wstęp

Wiercenie

Rozwiercanie

Wytaczanie

Załącznik

SD523

Głębokość wiercenia ~ 3 x D – Metryczne/Calowe

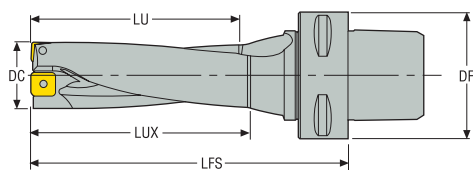

- Chwyt Seco-Capto™ C4
- Chłodzenie wewnętrzne
- Informacja na temat płytek patrz str. 292-298
- Parametry skrawania, patrz strona (strony) 301-302
- Średnice pośrednie patrz aplikacja MyDesign.

Oznaczenie	Numer produktu	DC		LUX		LFS		DF		Regulacja promieniowa	
		mm Cal.	mm Cal.	mm Cal.	mm Cal.	mm Cal.	mm Cal.	Płytki centralna	Płytki peryferyjna	mm - Cal. -	mm + Cal. +
SD523-15-45-C4	03080920	15,0 0.591	45,0 1.772	50,0 1.969	82,0 3.228	40,0 1.575	SPGX0502	SCGX050204	0,22 0.009	0,31 0.012	
SD523-15.5-47-C4	03080921	15,5 0.610	47,0 1.850	52,0 2.047	84,0 3.307	40,0 1.575	SPGX0502	SCGX050204	0,17 0.007	0,36 0.014	
SD523-16-48-C4	03080922	16,0 0.630	48,0 1.890	53,0 2.087	86,0 3.386	40,0 1.575	SPGX0502	SCGX050204	0,12 0.005	0,41 0.016	
SD523-16.5-50-C4	03080923	16,5 0.650	50,0 1.969	55,0 2.165	88,0 3.465	40,0 1.575	SPGX0502	SCGX050204	0,07 0.003	0,46 0.018	
SD523-17-51-C4	03080925	17,0 0.669	51,0 2.008	56,0 2.205	89,0 3.504	40,0 1.575	SPGX0502	SCGX050204	0,02 0.001	0,5 0.020	
SD523-17.5-53-C4	03080926	17,5 0.689	53,0 2.087	58,0 2.283	92,0 3.622	40,0 1.575	SPGX0602	SCGX050204	0,43 0.017	0,1 0.004	
SD523-18-54-C4	03080927	18,0 0.709	54,0 2.126	59,0 2.323	93,0 3.661	40,0 1.575	SPGX0602	SCGX050204	0,32 0.013	0,21 0.008	
SD523-18.5-56-C4	03080928	18,5 0.728	56,0 2.205	61,0 2.402	95,0 3.740	40,0 1.575	SPGX0602	SCGX050204	0,22 0.009	0,31 0.012	
SD523-19-57-C4	03080929	19,0 0.748	57,0 2.244	62,0 2.441	96,0 3.780	40,0 1.575	SPGX0602	SCGX050204	0,11 0.004	0,42 0.017	
SD523-20-60-C4	03080930	20,0 0.787	60,0 2.362	65,0 2.559	101,0 3.976	40,0 1.575	SPGX0602	SCGX060204	0,07 0.003	0,46 0.018	
SD523-20.62-62-C4	03081006	20,62 0.812	62,0 2.441	67,0 2.638	103,0 4.055	40,0 1.575	SPGX0602	SCGX060204	0,03 0.001	0,5 0.020	
SD523-21-63-C4	03080931	21,0 0.827	63,0 2.480	68,0 2.677	104,0 4.094	40,0 1.575	SPGX0602	SCGX060204	0,01 0	0,5 0.020	
SD523-22-66-C4	03080932	22,0 0.866	66,0 2.598	71,0 2.795	107,0 4.213	40,0 1.575	SPGX0703	SCGX060204	0,44 0.017	0,46 0.018	
SD523-22.23-67-C4	03081008	22,23 0.875	67,0 2.638	72,0 2.835	108,0 4.252	40,0 1.575	SPGX0703	SCGX060204	0,39 0.015	0,5 0.020	
SD523-23-69-C4	03080933	23,0 0.906	69,0 2.717	74,0 2.913	111,0 4.370	40,0 1.575	SPGX0703	SCGX070308	0,33 0.013	0,5 0.020	
SD523-24-72-C4	03080934	24,0 0.945	72,0 2.835	77,0 3.031	115,0 4.528	40,0 1.575	SPGX0703	SCGX070308	0,11 0.004	0,5 0.020	
SD523-25-75-C4	03080935	25,0 0.984	75,0 2.953	80,0 3.150	119,0 4.685	40,0 1.575	SPGX0703	SCGX070308	0,11 0.004	0,5 0.020	
SD523-25.4-77-C4	03081009	25,4 1.000	77,0 3.031	82,0 3.228	121,0 4.764	40,0 1.575	SPGX0703	SCGX070308	0,11 0.004	0,5 0.020	
SD523-26-78-C4	03080936	26,0 1.024	78,0 3.071	83,0 3.268	122,0 4.803	40,0 1.575	SPGX0903	SCGX070308	0,5 0.020	0,11 0.004	
SD523-27-81-C4	03080937	27,0 1.063	81,0 3.189	86,0 3.386	125,0 4.921	40,0 1.575	SPGX0903	SCGX070308	0,5 0.020	0,26 0.010	
SD523-28-84-C4	03080938	28,0 1.102	84,0 3.307	89,0 3.504	129,0 5.079	40,0 1.575	SPGX0903	SCGX070308	0,28 0.011	0,5 0.020	

Wstęp

Wiercenie



Rozwiercanie

Wytłaczanie



Załącznik

Oznaczenie	Numer produktu	DC	LU	LUX	LFS	DF	Płytki		Regulacja promieniowa	
		mm Cal.	mm Cal.	mm Cal.	mm Cal.	mm Cal.	Płytki centralna	Płytki peryferyjna	mm - Cal. -	mm + Cal. +
SD523-28.59-86-C4	03081010	28,59 1.126	86,0 3.386	91,0 3.583	131,0 5.157	40,0 1.575	SPGX0903	SCGX09T308	0,21 0.008	0,5 0.020
SD523-29-87-C4	03080939	29,0 1.142	87,0 3.425	92,0 3.622	132,0 5.197	40,0 1.575	SPGX0903	SCGX09T308	0,18 0.007	0,5 0.020
SD523-30-90-C4	03080940	30,0 1.181	90,0 3.543	95,0 3.740	135,0 5.315	40,0 1.575	SPGX0903	SCGX09T308	0,12 0.005	0,5 0.020

Części zamienne, zawarte w dostawie

Dla śred. wiertła (mm)	Śruba mocująca płytkę		Klucz do płytek
			
	Płytki centralna	Płytki zewn.	
15,00-17,45	C02245-T07P	C02245-T07P	T07P-2
17,46-19,49	C02205-T07P	C02245-T07P	T07P-2
19,50-21,24	C02205-T07P	C02205-T07P	T07P-2
21,25-22,49	C02506-T08P	C02506-T08P	T08P-2
22,50-25,49	C02507-T08P	C03007-T08P	T08P-2
25,50-28,49	C03007-T09P	C03007-T09P	T09P-2
28,50-31,49	C03007-T09P	C03009-T09P	T09P-2
31,50-40,49	C03508-T15P	C03508-T15P	T15P-2D
40,50-43,24	C03508-T15P	C05012-T15P	T15P-2D
43,25-59,00	C04011-T15P	C05012-T15P	T15P-2D

Akcesoria

Dla śred. wiertła (mm)	Klucz dynamometryczny*	Wkładka wymienna	Wielk. mom.
			
15,00-17,45	T00-07P09	T00-07P	0,9 Nm
17,46-19,49	T00-07P09	T00-07P	0,9 Nm
19,50-21,24	T00-07P09	T00-07P	0,9 Nm
21,25-22,49	T00-08P12	T00-08P	1,2 Nm
22,50-25,49	T00-08P12	T00-08P	1,2 Nm
25,50-28,49	T00-09P20	T00-09P	2,0 Nm
28,50-31,49	T00-09P20	T00-09P	2,0 Nm
31,50-40,49	T00-15P30	T00-15P	3,0 Nm
40,50-43,24	T00-15P30	T00-15P	3,0 Nm
43,25-59,00	T00-15P30	T00-15P	3,0 Nm

*Zawiera płytkę.

Wstęp

Wiercenie

Rozwiercanie

Wyłaczanie

Załącznik

SD523

Głębokość wiercenia ~ 3 x D – Metryczne/Calowe

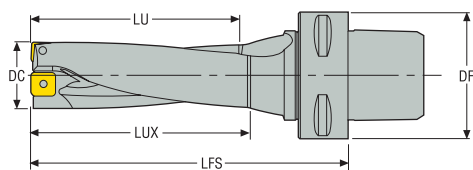

- Chwyt Seco-Capto™ C5
- Chłodzenie wewnętrzne
- Informacja na temat płytek patrz str. 292-298
- Parametry skrawania, patrz strona (strony) 301-302
- Średnice pośrednie patrz aplikacja MyDesign.

Oznaczenie	Numer produktu	DC		LUX		LFS		DF		Regulacja promieniowa	
		mm Cal.	mm Cal.	mm Cal.	mm Cal.	mm Cal.	mm Cal.	Płytki centralna	Płytki peryferyjna	mm - Cal. -	mm + Cal. +
SD523-15-45-C5	03080941	15,0 0.591	45,0 1.772	50,0 1.969	82,0 3.228	50,0 1.969	SPGX0502	SCGX050204	0,22 0.009	0,31 0.012	
SD523-15.5-47-C5	03080942	15,5 0.610	47,0 1.850	52,0 2.047	84,0 3.307	50,0 1.969	SPGX0502	SCGX050204	0,17 0.007	0,36 0.014	
SD523-16-48-C5	03080943	16,0 0.630	48,0 1.890	53,0 2.087	86,0 3.386	50,0 1.969	SPGX0502	SCGX050204	0,12 0.005	0,41 0.016	
SD523-16.5-50-C5	03080944	16,5 0.650	50,0 1.969	55,0 2.165	88,0 3.465	50,0 1.969	SPGX0502	SCGX050204	0,07 0.003	0,46 0.018	
SD523-17-51-C5	03080945	17,0 0.669	51,0 2.008	56,0 2.205	89,0 3.504	50,0 1.969	SPGX0502	SCGX050204	0,02 0.001	0,5 0.020	
SD523-17.5-53-C5	03080946	17,5 0.689	53,0 2.087	58,0 2.283	92,0 3.622	50,0 1.969	SPGX0602	SCGX050204	0,43 0.017	0,1 0.004	
SD523-18-54-C5	03080947	18,0 0.709	54,0 2.126	59,0 2.323	93,0 3.661	50,0 1.969	SPGX0602	SCGX050204	0,32 0.013	0,21 0.008	
SD523-18.5-56-C5	03080948	18,5 0.728	56,0 2.205	61,0 2.402	95,0 3.740	50,0 1.969	SPGX0602	SCGX050204	0,22 0.009	0,31 0.012	
SD523-19-57-C5	03080949	19,0 0.748	57,0 2.244	62,0 2.441	96,0 3.780	50,0 1.969	SPGX0602	SCGX050204	0,11 0.004	0,42 0.017	
SD523-20-60-C5	03080950	20,0 0.787	60,0 2.362	65,0 2.559	101,0 3.976	50,0 1.969	SPGX0602	SCGX060204	0,07 0.003	0,46 0.018	
SD523-20.62-62-C5	03081001	20,62 0.812	62,0 2.441	67,0 2.638	103,0 4.055	50,0 1.969	SPGX0602	SCGX060204	0,03 0.001	0,5 0.020	
SD523-21-63-C5	03080951	21,0 0.827	63,0 2.480	68,0 2.677	104,0 4.094	50,0 1.969	SPGX0602	SCGX060204	0,01 0	0,5 0.020	
SD523-22-66-C5	03080952	22,0 0.866	66,0 2.598	71,0 2.795	107,0 4.213	50,0 1.969	SPGX0703	SCGX060204	0,44 0.017	0,46 0.018	
SD523-22.23-67-C5	03081002	22,23 0.875	67,0 2.638	72,0 2.835	108,0 4.252	50,0 1.969	SPGX0703	SCGX060204	0,39 0.015	0,5 0.020	
SD523-23-69-C5	03080953	23,0 0.906	69,0 2.717	74,0 2.913	111,0 4.370	50,0 1.969	SPGX0703	SCGX070308	0,33 0.013	0,5 0.020	
SD523-24-72-C5	03080954	24,0 0.945	72,0 2.835	77,0 3.031	115,0 4.528	50,0 1.969	SPGX0703	SCGX070308	0,11 0.004	0,5 0.020	
SD523-25-75-C5	03080955	25,0 0.984	75,0 2.953	80,0 3.150	119,0 4.685	50,0 1.969	SPGX0703	SCGX070308	0,11 0.004	0,5 0.020	
SD523-25.4-77-C5	03081003	25,4 1.000	77,0 3.031	82,0 3.228	121,0 4.764	50,0 1.969	SPGX0703	SCGX070308	0,11 0.004	0,5 0.020	
SD523-26-78-C5	03080956	26,0 1.024	78,0 3.071	83,0 3.268	122,0 4.803	50,0 1.969	SPGX0903	SCGX070308	0,5 0.020	0,11 0.004	
SD523-27-81-C5	03080957	27,0 1.063	81,0 3.189	86,0 3.386	125,0 4.921	50,0 1.969	SPGX0903	SCGX070308	0,5 0.020	0,26 0.010	
SD523-28-84-C5	03080958	28,0 1.102	84,0 3.307	89,0 3.504	129,0 5.079	50,0 1.969	SPGX0903	SCGX070308	0,28 0.011	0,5 0.020	

Wstęp

Wiercenie

Rozwiercanie

Wytłaczanie

Załącznik

Oznaczenie	Numer produktu	DC	LU	LUX	LFS	DF	Płytki		Regulacja promieniowa	
							Płytki centralna	Płytki peryferyjna	mm - Cal. -	mm + Cal. +
		mm Cal.	mm Cal.	mm Cal.	mm Cal.	mm Cal.			mm - Cal. -	mm + Cal. +
SD523-28.59-86-C5	03081004	28,59 1.126	86,0 3.386	91,0 3.583	131,0 5.157	50,0 1.969	SPGX0903	SCGX09T308	0,21 0.008	0,5 0.020
SD523-29.87-C5	03080959	29,0 1.142	87,0 3.425	92,0 3.622	132,0 5.197	50,0 1.969	SPGX0903	SCGX09T308	0,18 0.007	0,5 0.020
SD523-30.90-C5	03080960	30,0 1.181	90,0 3.543	95,0 3.740	135,0 5.315	50,0 1.969	SPGX0903	SCGX09T308	0,12 0.005	0,5 0.020
SD523-31.93-C5	03080961	31,0 1.220	93,0 3.661	98,0 3.858	138,0 5.433	50,0 1.969	SPGX0903	SCGX09T308	0,12 0.005	0,5 0.020
SD523-31.75-96-C5	03081005	31,75 1.250	96,0 3.780	101,0 3.976	142,0 5.591	50,0 1.969	SPGX11T3	SCGX09T308	0,5 0.020	0,28 0.011
SD523-32.96-C5	03080962	32,0 1.260	96,0 3.780	101,0 3.976	142,0 5.591	50,0 1.969	SPGX11T3	SCGX09T308	0,5 0.020	0,31 0.012
SD523-33.99-C5	03080963	33,0 1.299	99,0 3.898	104,0 4.094	145,0 5.709	50,0 1.969	SPGX11T3	SCGX09T308	0,5 0.020	0,46 0.018
SD523-34.102-C5	03080964	34,0 1.339	102,0 4.016	107,0 4.213	148,0 5.827	50,0 1.969	SPGX11T3	SCGX09T308	0,22 0.009	0,5 0.020
SD523-35.105-C5	03080965	35,0 1.378	105,0 4.134	110,0 4.331	151,0 5.945	50,0 1.969	SPGX11T3	SCGX11T308	0,22 0.009	0,5 0.020
SD523-36.108-C5	03080966	36,0 1.417	108,0 4.252	113,0 4.449	154,0 6.063	50,0 1.969	SPGX11T3	SCGX11T308	0,09 0.004	0,5 0.020
SD523-37.111-C5	03080967	37,0 1.457	111,0 4.370	116,0 4.567	157,0 6.181	50,0 1.969	SPGX11T3	SCGX11T308	0,09 0.004	0,5 0.020
SD523-38.114-C5	03080968	38,0 1.496	114,0 4.488	119,0 4.685	160,0 6.299	50,0 1.969	SPGX12T3	SCGX11T308	0,5 0.020	0,5 0.020
SD523-39.117-C5	03080969	39,0 1.535	117,0 4.606	122,0 4.803	163,0 6.417	50,0 1.969	SPGX12T3	SCGX11T308	0,39 0.015	0,5 0.020
SD523-40.120-C5	03080970	40,0 1.575	120,0 4.724	125,0 4.921	166,0 6.535	50,0 1.969	SPGX12T3	SCGX11T308	0,19 0.007	0,5 0.020

Części zamienne, zawarte w dostawie

Długość średnicy wiertła (mm)	Śruba mocująca płytkę		Klucz do płytek
	Płytki centralna	Płytki zewn.	
15,00-17,45	C02245-T07P	C02245-T07P	T07P-2
17,46-19,49	C02205-T07P	C02245-T07P	T07P-2
19,50-21,24	C02205-T07P	C02205-T07P	T07P-2
21,25-22,49	C02506-T08P	C02506-T08P	T08P-2
22,50-25,49	C02507-T08P	C03007-T08P	T08P-2
25,50-28,49	C03007-T09P	C03007-T09P	T09P-2
28,50-31,49	C03007-T09P	C03009-T09P	T09P-2
31,50-40,49	C03508-T15P	C03508-T15P	T15P-2D
40,50-43,24	C03508-T15P	C05012-T15P	T15P-2D
43,25-59,00	C04011-T15P	C05012-T15P	T15P-2D

Wstęp



Wiercenie

Rozwiercanie

Wyłaczanie

Załącznik

Akcesoria

Dla śred. wiertła (mm)	Klucz dynamometryczny*	Wkładka wymienna	Wielk. mom.
			
15,00-17,45	T00-07P09	T00-07P	0,9 Nm
17,46-19,49	T00-07P09	T00-07P	0,9 Nm
19,50-21,24	T00-07P09	T00-07P	0,9 Nm
21,25-22,49	T00-08P12	T00-08P	1,2 Nm
22,50-25,49	T00-08P12	T00-08P	1,2 Nm
25,50-28,49	T00-09P20	T00-09P	2,0 Nm
28,50-31,49	T00-09P20	T00-09P	2,0 Nm
31,50-40,49	T00-15P30	T00-15P	3,0 Nm
40,50-43,24	T00-15P30	T00-15P	3,0 Nm
43,25-59,00	T00-15P30	T00-15P	3,0 Nm

*Zawiera płytkę.

Wstęp

Wiercenie

Rozwiercanie

Wyłaczanie

Załącznik

SD523

Głębokość wiercenia ~ 3 x D – Metryczne/Calowe

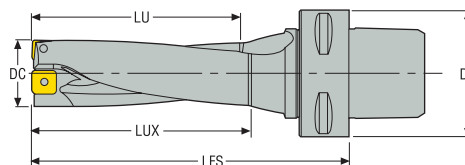

- Chwyt Seco-Capto™ C6
- Chłodzenie wewnętrzne
- Informacja na temat płytek patrz str. 292-298
- Parametry skrawania, patrz strona (strony) 301-302
- Średnice pośrednie patrz aplikacja MyDesign.

Oznaczenie	Numer produktu	DC	LU	LUX	LFS	DF	Regulacja promieniowa			
							Płytki centralna	Płytki peryferyjna	mm - Cal. -	mm + Cal. +
SD523-15-45-C6	03080971	15,0 0.591	45,0 1.772	50,0 1.969	84,0 3.307	63,0 2.480	SPGX0502	SCGX050204	0,22 0.009	0,31 0.012
SD523-15.5-47-C6	03080972	15,5 0.610	47,0 1.850	52,0 2.047	86,0 3.386	63,0 2.480	SPGX0502	SCGX050204	0,17 0.007	0,36 0.014
SD523-16-48-C6	03080973	16,0 0.630	48,0 1.890	53,0 2.087	88,0 3.465	63,0 2.480	SPGX0502	SCGX050204	0,12 0.005	0,41 0.016
SD523-16.5-50-C6	03080974	16,5 0.650	50,0 1.969	55,0 2.165	90,0 3.543	63,0 2.480	SPGX0502	SCGX050204	0,07 0.003	0,46 0.018
SD523-17-51-C6	03080975	17,0 0.669	51,0 2.008	56,0 2.205	91,0 3.583	63,0 2.480	SPGX0502	SCGX050204	0,02 0.001	0,5 0.020
SD523-17.5-53-C6	03080976	17,5 0.689	53,0 2.087	58,0 2.283	94,0 3.701	63,0 2.480	SPGX0602	SCGX050204	0,43 0.017	0,1 0.004
SD523-18-54-C6	03080977	18,0 0.709	54,0 2.126	59,0 2.323	95,0 3.740	63,0 2.480	SPGX0602	SCGX050204	0,32 0.013	0,21 0.008
SD523-18.5-56-C6	03080978	18,5 0.728	56,0 2.205	61,0 2.402	97,0 3.819	63,0 2.480	SPGX0602	SCGX050204	0,22 0.009	0,31 0.012
SD523-19-57-C6	03080979	19,0 0.748	57,0 2.244	62,0 2.441	98,0 3.858	63,0 2.480	SPGX0602	SCGX050204	0,11 0.004	0,42 0.017
SD523-20-60-C6	03080980	20,0 0.787	60,0 2.362	65,0 2.559	103,0 4.055	63,0 2.480	SPGX0602	SCGX060204	0,07 0.003	0,46 0.018
SD523-20.62-62-C6	03081011	20,62 0.812	62,0 2.441	67,0 2.638	105,0 4.134	63,0 2.480	SPGX0602	SCGX060204	0,03 0.001	0,5 0.020
SD523-21-63-C6	03080981	21,0 0.827	63,0 2.480	68,0 2.677	106,0 4.173	63,0 2.480	SPGX0602	SCGX060204	0,01 0	0,5 0.020
SD523-22-66-C6	03080982	22,0 0.866	66,0 2.598	71,0 2.795	109,0 4.291	63,0 2.480	SPGX0703	SCGX060204	0,44 0.017	0,46 0.018
SD523-22.23-67-C6	03081012	22,23 0.875	67,0 2.638	72,0 2.835	110,0 4.331	63,0 2.480	SPGX0703	SCGX060204	0,39 0.015	0,5 0.020
SD523-23-69-C6	03080983	23,0 0.906	69,0 2.717	74,0 2.913	113,0 4.449	63,0 2.480	SPGX0703	SCGX070308	0,33 0.013	0,5 0.020
SD523-24-72-C6	03080984	24,0 0.945	72,0 2.835	77,0 3.031	117,0 4.606	63,0 2.480	SPGX0703	SCGX070308	0,11 0.004	0,5 0.020
SD523-25-75-C6	03080985	25,0 0.984	75,0 2.953	80,0 3.150	121,0 4.764	63,0 2.480	SPGX0703	SCGX070308	0,11 0.004	0,5 0.020
SD523-25.4-77-C6	03081013	25,4 1.000	77,0 3.031	82,0 3.228	123,0 4.843	63,0 2.480	SPGX0703	SCGX070308	0,11 0.004	0,5 0.020
SD523-26-78-C6	03080986	26,0 1.024	78,0 3.071	83,0 3.268	124,0 4.882	63,0 2.480	SPGX0903	SCGX070308	0,5 0.020	0,11 0.004
SD523-27-81-C6	03080987	27,0 1.063	81,0 3.189	86,0 3.386	127,0 5.000	63,0 2.480	SPGX0903	SCGX070308	0,5 0.020	0,26 0.010
SD523-28-84-C6	03080988	28,0 1.102	84,0 3.307	89,0 3.504	131,0 5.157	63,0 2.480	SPGX0903	SCGX070308	0,28 0.011	0,5 0.020
SD523-28.59-86-C6	03081014	28,59 1.126	86,0 3.386	91,0 3.583	133,0 5.236	63,0 2.480	SPGX0903	SCGX09T308	0,21 0.008	0,5 0.020

Wstęp

Wiercenie



Rozwiercanie

Wytaczanie

Załącznik

Oznaczenie	Numer produktu	DC	LU	LUX	LFS	DF	Płytki		Regulacja promieniowa	
		mm Cal.	mm Cal.	mm Cal.	mm Cal.	mm Cal.	Płytki centralna	Płytki peryferyjna	mm - Cal. -	mm + Cal. +
SD523-29-87-C6	03080989	29,0 1.142	87,0 3.425	92,0 3.622	134,0 5.276	63,0 2.480	SPGX0903	SCGX09T308	0,18 0.007	0,5 0.020
SD523-30-90-C6	03080990	30,0 1.181	90,0 3.543	95,0 3.740	137,0 5.394	63,0 2.480	SPGX0903	SCGX09T308	0,12 0.005	0,5 0.020
SD523-31-93-C6	03080991	31,0 1.220	93,0 3.661	98,0 3.858	140,0 5.512	63,0 2.480	SPGX0903	SCGX09T308	0,12 0.005	0,5 0.020
SD523-31.75-96-C6	03081015	31,75 1.250	96,0 3.780	101,0 3.976	144,0 5.669	63,0 2.480	SPGX11T3	SCGX09T308	0,5 0.020	0,28 0.011
SD523-32-96-C6	03080992	32,0 1.260	96,0 3.780	101,0 3.976	144,0 5.669	63,0 2.480	SPGX11T3	SCGX09T308	0,5 0.020	0,31 0.012
SD523-33-99-C6	03080993	33,0 1.299	99,0 3.898	104,0 4.094	147,0 5.787	63,0 2.480	SPGX11T3	SCGX09T308	0,5 0.020	0,46 0.018
SD523-34-102-C6	03080994	34,0 1.339	102,0 4.016	107,0 4.213	150,0 5.906	63,0 2.480	SPGX11T3	SCGX09T308	0,22 0.009	0,5 0.020
SD523-35-105-C6	03080995	35,0 1.378	105,0 4.134	110,0 4.331	153,0 6.024	63,0 2.480	SPGX11T3	SCGX11T308	0,22 0.009	0,5 0.020
SD523-36-108-C6	03080996	36,0 1.417	108,0 4.252	113,0 4.449	156,0 6.142	63,0 2.480	SPGX11T3	SCGX11T308	0,09 0.004	0,5 0.020
SD523-37-111-C6	03080997	37,0 1.457	111,0 4.370	116,0 4.567	159,0 6.260	63,0 2.480	SPGX11T3	SCGX11T308	0,09 0.004	0,5 0.020
SD523-38-114-C6	03080998	38,0 1.496	114,0 4.488	119,0 4.685	162,0 6.378	63,0 2.480	SPGX12T3	SCGX11T308	0,5 0.020	0,5 0.020
SD523-39-117-C6	03080999	39,0 1.535	117,0 4.606	122,0 4.803	165,0 6.496	63,0 2.480	SPGX12T3	SCGX11T308	0,39 0.015	0,5 0.020
SD523-40-120-C6	03081000	40,0 1.575	120,0 4.724	125,0 4.921	168,0 6.614	63,0 2.480	SPGX12T3	SCGX11T308	0,19 0.007	0,5 0.020

Części zamienne, zawarte w dostawie

Dla śred. wiertła (mm)	Śruba mocująca płytkę		Klucz do płytek
			
	Płytki centralna	Płytki zewn.	
15,00-17,45	C02245-T07P	C02245-T07P	T07P-2
17,46-19,49	C02205-T07P	C02245-T07P	T07P-2
19,50-21,24	C02205-T07P	C02205-T07P	T07P-2
21,25-22,49	C02506-T08P	C02506-T08P	T08P-2
22,50-25,49	C02507-T08P	C03007-T08P	T08P-2
25,50-28,49	C03007-T09P	C03007-T09P	T09P-2
28,50-31,49	C03007-T09P	C03009-T09P	T09P-2
31,50-40,49	C03508-T15P	C03508-T15P	T15P-2D
40,50-43,24	C03508-T15P	C05012-T15P	T15P-2D
43,25-59,00	C04011-T15P	C05012-T15P	T15P-2D

Akcesoria

Dla śred. wiertła (mm)	Klucz dynamometryczny*	Wkładka wymienna	Wielk. mom.
15,00-17,45	T00-07P09	T00-07P	0,9 Nm
17,46-19,49	T00-07P09	T00-07P	0,9 Nm
19,50-21,24	T00-07P09	T00-07P	0,9 Nm
21,25-22,49	T00-08P12	T00-08P	1,2 Nm
22,50-25,49	T00-08P12	T00-08P	1,2 Nm
25,50-28,49	T00-09P20	T00-09P	2,0 Nm
28,50-31,49	T00-09P20	T00-09P	2,0 Nm
31,50-40,49	T00-15P30	T00-15P	3,0 Nm
40,50-43,24	T00-15P30	T00-15P	3,0 Nm
43,25-59,00	T00-15P30	T00-15P	3,0 Nm

*Zawiera płytkę.

Wstęp

Wiercenie

Rozwiercanie

Wytaczanie

Załącznik

SD524

Głębokość wiercenia ~ 4 x D – Metryczne/Calowe

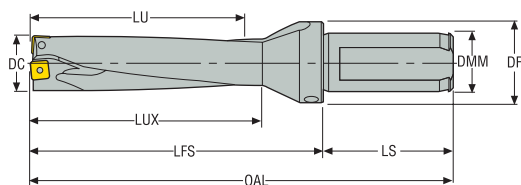

- Chwył ISO 9766, -7
- Chłodzenie wewnętrzne
- Informacja na temat płytek patrz str. 292-298
- Parametry skrawania, patrz strona (strony) 303, 304
- Średnice pośrednie patrz aplikacja MyDesign.

Oznaczenie	Numer produktu	DC	LU	OAL	LUX	LFS	LS	DMM	DF	Płytki	
		mm Cal.	mm Cal.	mm Cal.	mm Cal.	mm Cal.	mm Cal.	mm Cal.	mm Cal.	Płytki centralna	Płytki peryferyjna
SD524-17-68-25R7	03080330	17,0 0.669	68,0 2.677	154,0 6.063	73,0 2.874	98,0 3.858	56,0 2.205	25,0 0.984	35,0 1.378	SPGX0502	SCGX050204
SD524-17.5-70-25R7	03080326	17,5 0.689	70,0 2.756	156,0 6.142	75,0 2.953	100,0 3.937	56,0 2.205	25,0 0.984	35,0 1.378	SPGX0602	SCGX050204
SD524-18-72-25R7	03080333	18,0 0.709	72,0 2.835	158,0 6.220	77,0 3.031	102,0 4.016	56,0 2.205	25,0 0.984	35,0 1.378	SPGX0602	SCGX050204
SD524-18.5-74-25R7	03080331	18,5 0.728	74,0 2.913	160,0 6.299	79,0 3.110	104,0 4.094	56,0 2.205	25,0 0.984	35,0 1.378	SPGX0602	SCGX050204
SD524-19-76-25R7	03080336	19,0 0.748	76,0 2.992	162,0 6.378	81,0 3.189	106,0 4.173	56,0 2.205	25,0 0.984	35,0 1.378	SPGX0602	SCGX050204
SD524-20-80-25R7	03080340	20,0 0.787	80,0 3.150	166,0 6.535	85,0 3.346	110,0 4.331	56,0 2.205	25,0 0.984	35,0 1.378	SPGX0602	SCGX060204
SD524-21-84-25R7	03080344	21,0 0.827	84,0 3.307	170,0 6.693	89,0 3.504	114,0 4.488	56,0 2.205	25,0 0.984	35,0 1.378	SPGX0602	SCGX060204
SD524-22-88-25R7	03080348	22,0 0.866	88,0 3.465	174,0 6.850	93,0 3.661	118,0 4.646	56,0 2.205	25,0 0.984	35,0 1.378	SPGX0703	SCGX060204
SD524-23-92-25R7	03080351	23,0 0.906	92,0 3.622	178,0 7.008	97,0 3.819	122,0 4.803	56,0 2.205	25,0 0.984	35,0 1.378	SPGX0703	SCGX070308
SD524-24-96-25R7	03080352	24,0 0.945	96,0 3.780	182,0 7.165	101,0 3.976	126,0 4.961	56,0 2.205	25,0 0.984	35,0 1.378	SPGX0703	SCGX070308
SD524-25-100-32R7	03080353	25,0 0.984	100,0 3.937	190,0 7.480	105,0 4.134	130,0 5.118	60,0 2.362	32,0 1.260	42,0 1.654	SPGX0703	SCGX070308
SD524-26-104-32R7	03080354	26,0 1.024	104,0 4.094	194,0 7.638	109,0 4.291	134,0 5.276	60,0 2.362	32,0 1.260	42,0 1.654	SPGX0903	SCGX070308
SD524-27-108-32R7	03080355	27,0 1.063	108,0 4.252	198,0 7.795	113,0 4.449	138,0 5.433	60,0 2.362	32,0 1.260	42,0 1.654	SPGX0903	SCGX070308
SD524-28-112-32R7	03080356	28,0 1.102	112,0 4.409	202,0 7.953	117,0 4.606	142,0 5.591	60,0 2.362	32,0 1.260	42,0 1.654	SPGX0903	SCGX070308
SD524-29-116-32R7	03080357	29,0 1.142	116,0 4.567	206,0 8.110	121,0 4.764	146,0 5.748	60,0 2.362	32,0 1.260	42,0 1.654	SPGX0903	SCGX09T308
SD524-30-120-32R7	03080358	30,0 1.181	120,0 4.724	210,0 8.268	125,0 4.921	150,0 5.906	60,0 2.362	32,0 1.260	42,0 1.654	SPGX0903	SCGX09T308
SD524-31-124-32R7	03080360	31,0 1.220	124,0 4.882	214,0 8.425	129,0 5.079	154,0 6.063	60,0 2.362	32,0 1.260	42,0 1.654	SPGX0903	SCGX09T308
SD524-32-128-40R7	03080361	32,0 1.260	128,0 5.039	226,0 8.898	133,0 5.236	158,0 6.220	68,0 2.677	40,0 1.575	50,0 1.969	SPGX11T3	SCGX09T308
SD524-33-132-40R7	03080362	33,0 1.299	132,0 5.197	230,0 9.055	137,0 5.394	162,0 6.378	68,0 2.677	40,0 1.575	50,0 1.969	SPGX11T3	SCGX09T308
SD524-34-136-40R7	03080363	34,0 1.339	136,0 5.354	234,0 9.213	141,0 5.551	166,0 6.535	68,0 2.677	40,0 1.575	50,0 1.969	SPGX11T3	SCGX09T308
SD524-35-140-40R7	03080364	35,0 1.378	140,0 5.512	238,0 9.370	145,0 5.709	170,0 6.693	68,0 2.677	40,0 1.575	50,0 1.969	SPGX11T3	SCGX11T308

Wstęp

Wiercenie

Rozwiercanie

Wylacznik

Zalacznik

Oznaczenie	Numer produktu	DC	LU	OAL	LUX	LFS	LS	DMM	DF	Płytki	
		mm Cal.	mm Cal.	mm Cal.	mm Cal.	mm Cal.	mm Cal.	mm Cal.	mm Cal.	mm Cal.	Płytki centralna
SD524-36-144-40R7	03080365	36,0 1.417	144,0 5.669	242,0 9.528	149,0 5.866	174,0 6.850	68,0 2.677	40,0 1.575	50,0 1.969	SPGX11T3	SCGX11T308
SD524-37-148-40R7	03080366	37,0 1.457	148,0 5.827	246,0 9.685	153,0 6.024	178,0 7.008	68,0 2.677	40,0 1.575	50,0 1.969	SPGX11T3	SCGX11T308
SD524-38-152-40R7	03080367	38,0 1.496	152,0 5.984	250,0 9.843	157,0 6.181	182,0 7.165	68,0 2.677	40,0 1.575	50,0 1.969	SPGX12T3	SCGX11T308
SD524-39-156-40R7	03080368	39,0 1.535	156,0 6.142	254,0 10.000	161,0 6.339	186,0 7.323	68,0 2.677	40,0 1.575	50,0 1.969	SPGX12T3	SCGX11T308
SD524-40-160-40R7	03080369	40,0 1.575	160,0 6.299	258,0 10.157	165,0 6.496	190,0 7.480	68,0 2.677	40,0 1.575	50,0 1.969	SPGX12T3	SCGX11T308
SD524-41-164-40R7	03080370	41,0 1.614	164,0 6.457	262,0 10.315	169,0 6.654	194,0 7.638	68,0 2.677	40,0 1.575	50,0 1.969	SPGX12T3	SCGX120408
SD524-42-168-40R7	03080371	42,0 1.654	168,0 6.614	266,0 10.472	173,0 6.811	198,0 7.795	68,0 2.677	40,0 1.575	50,0 1.969	SPGX12T3	SCGX120408
SD524-43-172-40R7	03080372	43,0 1.693	172,0 6.772	270,0 10.630	177,0 6.969	202,0 7.953	68,0 2.677	40,0 1.575	50,0 1.969	SPGX12T3	SCGX120408
SD524-44-176-40R7	03080373	44,0 1.732	176,0 6.929	274,0 10.787	181,0 7.126	206,0 8.110	68,0 2.677	40,0 1.575	50,0 1.969	SPGX1504	SCGX120408
SD524-45-180-40R7	03080374	45,0 1.772	180,0 7.087	278,0 10.945	185,0 7.283	210,0 8.268	68,0 2.677	40,0 1.575	50,0 1.969	SPGX1504	SCGX150512
SD524-46-184-40R7	03080375	46,0 1.811	184,0 7.244	282,0 11.102	189,0 7.441	214,0 8.425	68,0 2.677	40,0 1.575	50,0 1.969	SPGX1504	SCGX150512
SD524-47-188-40R7	03080376	47,0 1.850	188,0 7.402	286,0 11.260	193,0 7.598	218,0 8.583	68,0 2.677	40,0 1.575	50,0 1.969	SPGX1504	SCGX150512
SD524-48-192-40R7	03080377	48,0 1.890	192,0 7.559	290,0 11.417	197,0 7.756	222,0 8.740	68,0 2.677	40,0 1.575	59,35 2.337	SPGX1504	SCGX150512
SD524-49-196-40R7	03080378	49,0 1.929	196,0 7.717	294,0 11.575	201,0 7.913	226,0 8.898	68,0 2.677	40,0 1.575	59,35 2.337	SPGX1504	SCGX150512
SD524-50-200-40R7	03080379	50,0 1.969	200,0 7.874	298,0 11.732	205,0 8.071	230,0 9.055	68,0 2.677	40,0 1.575	59,35 2.337	SPGX1504	SCGX150512
SD524-51-204-40R7	03080380	51,0 2.008	204,0 8.031	302,0 11.890	209,0 8.228	234,0 9.213	68,0 2.677	40,0 1.575	59,35 2.337	SPGX1504	SCGX150512
SD524-52-208-40R7	03080381	52,0 2.047	208,0 8.189	306,0 12.047	213,0 8.386	238,0 9.370	68,0 2.677	40,0 1.575	59,35 2.337	SPGX1904	SCGX150512
SD524-53-212-40R7	03080382	53,0 2.087	212,0 8.346	310,0 12.205	217,0 8.543	242,0 9.528	68,0 2.677	40,0 1.575	59,35 2.337	SPGX1904	SCGX150512
SD524-54-216-40R7	03080383	54,0 2.126	216,0 8.504	314,0 12.362	221,0 8.701	246,0 9.685	68,0 2.677	40,0 1.575	59,35 2.337	SPGX1904	SCGX150512
SD524-55-220-40R7	03080384	55,0 2.165	220,0 8.661	318,0 12.520	225,0 8.858	250,0 9.843	68,0 2.677	40,0 1.575	59,35 2.337	SPGX1904	SCGX150512
SD524-56-224-40R7	03080385	56,0 2.205	224,0 8.819	322,0 12.677	229,0 9.016	254,0 10.000	68,0 2.677	40,0 1.575	59,35 2.337	SPGX1904	SCGX150512
SD524-57-228-40R7	03080386	57,0 2.244	228,0 8.976	326,0 12.835	233,0 9.173	258,0 10.157	68,0 2.677	40,0 1.575	59,35 2.337	SPGX1904	SCGX150512
SD524-58-232-40R7	03080387	58,0 2.283	232,0 9.134	330,0 12.992	237,0 9.331	262,0 10.315	68,0 2.677	40,0 1.575	63,0 2.480	SPGX1904	SCGX150512
SD524-59-236-40R7	03080388	59,0 2.323	236,0 9.291	334,0 13.150	241,0 9.488	266,0 10.472	68,0 2.677	40,0 1.575	63,0 2.480	SPGX1904	SCGX150512

Wstęp



Wiercenie

Rozwiercanie



Wytaczanie

Załącznik

Części zamienne, zawarte w dostawie

Dla śred. wiertła (mm)	Śruba mocująca płytkę		Klucz do płytek
			
	Płytką centralną	Płytką zewn.	
15,00-17,45	C02245-T07P	C02245-T07P	T07P-2
17,46-19,49	C02205-T07P	C02245-T07P	T07P-2
19,50-21,24	C02205-T07P	C02205-T07P	T07P-2
21,25-22,49	C02506-T08P	C02506-T08P	T08P-2
22,50-25,49	C02507-T08P	C03007-T08P	T08P-2
25,50-28,49	C03007-T09P	C03007-T09P	T09P-2
28,50-31,49	C03007-T09P	C03009-T09P	T09P-2
31,50-40,49	C03508-T15P	C03508-T15P	T15P-2D
40,50-43,24	C03508-T15P	C05012-T15P	T15P-2D
43,25-59,00	C04011-T15P	C05012-T15P	T15P-2D

Akcesoria

Dla śred. wiertła (mm)	Klucz dynamometryczny*	Wkładka wymienna	Wielk. mom.
			
15,00-17,45	T00-07P09	T00-07P	0,9 Nm
17,46-19,49	T00-07P09	T00-07P	0,9 Nm
19,50-21,24	T00-07P09	T00-07P	0,9 Nm
21,25-22,49	T00-08P12	T00-08P	1,2 Nm
22,50-25,49	T00-08P12	T00-08P	1,2 Nm
25,50-28,49	T00-09P20	T00-09P	2,0 Nm
28,50-31,49	T00-09P20	T00-09P	2,0 Nm
31,50-40,49	T00-15P30	T00-15P	3,0 Nm
40,50-43,24	T00-15P30	T00-15P	3,0 Nm
43,25-59,00	T00-15P30	T00-15P	3,0 Nm

*Zawiera płytkę.

SD524

Głębokość wiercenia ~ 4 x D – Calowe

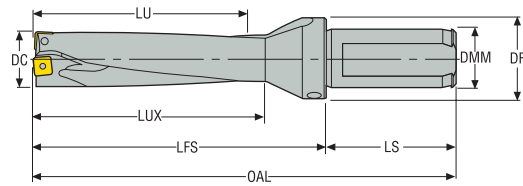

- Chwyt ISO 9766, R7
- Chłodzenie wewnętrzne
- Informacja na temat płytek patrz str. 292-298
- Parametry skrawania, patrz strona (strony) 303, 304
- Średnice pośrednie patrz aplikacja MyDesign.

Oznaczenie	Numer produktu	DC	LU	OAL	LUX	LFS	LS	DMM	DF	Płytki	
		Cal.	Cal.	Cal.	Cal.	Cal.	Cal.	Cal.	Cal.	Płytki centralna	Płytki peryferyjna
SD524-0594-238-1000R7	03080280	0.594	2.380	5.811	2.577	3.561	2.250	1.000	1.378	SPGX0502	SCGX050204
SD524-0625-250-1000R7	03080281	0.625	2.500	5.931	2.697	3.681	2.250	1.000	1.378	SPGX0502	SCGX050204
SD524-0656-262-1000R7	03080283	0.656	2.620	6.051	2.817	3.801	2.250	1.000	1.378	SPGX0502	SCGX050204
SD524-0687-275-1000R7	03080285	0.687	2.750	6.181	2.947	3.931	2.250	1.000	1.378	SPGX0502	SCGX050204
SD524-0709-284-1000R7	03080286	0.709	2.840	6.271	3.037	4.021	2.250	1.000	1.378	SPGX0602	SCGX050204
SD524-0750-300-1000R7	03080288	0.750	3.000	6.431	3.197	4.181	2.250	1.000	1.378	SPGX0602	SCGX050204
SD524-0766-306-1000R7	03080289	0.766	3.060	6.491	3.257	4.241	2.250	1.000	1.378	SPGX0602	SCGX050204
SD524-0787-315-1000R7	03080290	0.787	3.150	6.581	3.347	4.331	2.250	1.000	1.378	SPGX0602	SCGX060204
SD524-0812-325-1000R7	03080292	0.812	3.250	6.681	3.447	4.431	2.250	1.000	1.378	SPGX0602	SCGX060204
SD524-0827-331-1000R7	03080294	0.827	3.310	6.741	3.507	4.491	2.250	1.000	1.378	SPGX0602	SCGX060204
SD524-0875-350-1000R7	03080295	0.875	3.500	6.931	3.697	4.681	2.250	1.000	1.378	SPGX0703	SCGX060204
SD524-0906-362-1000R7	03080297	0.906	3.620	7.051	3.817	4.801	2.250	1.000	1.378	SPGX0703	SCGX070308
SD524-0922-369-1000R7	03080298	0.922	3.690	7.121	3.887	4.871	2.250	1.000	1.378	SPGX0703	SCGX070308
SD524-0937-375-1000R7	03080299	0.937	3.750	7.181	3.947	4.931	2.250	1.000	1.378	SPGX0703	SCGX070308
SD524-0984-394-1250R7	03080301	0.984	3.940	7.496	4.137	5.121	2.375	1.250	1.654	SPGX0703	SCGX070308
SD524-1000-400-1250R7	03080302	1.000	4.000	7.556	4.197	5.181	2.375	1.250	1.654	SPGX0703	SCGX070308
SD524-1032-413-1250R7	03080304	1.032	4.130	7.686	4.327	5.311	2.375	1.250	1.654	SPGX0903	SCGX070308
SD524-1062-425-1250R7	03080305	1.062	4.250	7.806	4.447	5.431	2.375	1.250	1.654	SPGX0903	SCGX070308
SD524-1109-443-1250R7	03080307	1.109	4.430	7.986	4.627	5.611	2.375	1.250	1.654	SPGX0903	SCGX070308
SD524-1125-450-1250R7	03080308	1.125	4.500	8.056	4.697	5.681	2.375	1.250	1.654	SPGX0903	SCGX09T308
SD524-1172-469-1250R7	03080310	1.172	4.690	8.246	4.887	5.871	2.375	1.250	1.654	SPGX0903	SCGX09T308
SD524-1187-475-1250R7	03080311	1.187	4.750	8.306	4.947	5.931	2.375	1.250	1.654	SPGX0903	SCGX09T308
SD524-1250-500-1500R7	03080314	1.250	5.000	8.806	5.197	6.181	2.625	1.500	1.969	SPGX11T3	SCGX09T308
SD524-1312-525-1500R7	03080315	1.312	5.250	9.056	5.447	6.431	2.625	1.500	1.969	SPGX11T3	SCGX09T308
SD524-1344-538-1500R7	03080317	1.344	5.380	9.186	5.577	6.561	2.625	1.500	1.969	SPGX11T3	SCGX09T308
SD524-1375-550-1500R7	03080318	1.375	5.500	9.306	5.697	6.681	2.625	1.500	1.969	SPGX11T3	SCGX11T308
SD524-1437-575-1500R7	03080320	1.437	5.750	9.556	5.947	6.931	2.625	1.500	1.969	SPGX11T3	SCGX11T308
SD524-1500-600-1500R7	03080322	1.500	6.000	9.806	6.197	7.181	2.625	1.500	1.969	SPGX12T3	SCGX11T308
SD524-1562-625-1500R7	03080323	1.562	6.250	10.056	6.447	7.431	2.625	1.500	1.969	SPGX12T3	SCGX11T308
SD524-1625-650-1500R7	03080324	1.625	6.500	10.306	6.697	7.681	2.625	1.500	1.969	SPGX12T3	SCGX120408
SD524-1687-675-1500R7	03080325	1.687	6.750	10.556	6.947	7.931	2.625	1.500	1.969	SPGX12T3	SCGX120408
SD524-1750-700-1500R7	03080328	1.750	7.000	10.806	7.197	8.181	2.625	1.500	1.969	SPGX1504	SCGX120408
SD524-1812-725-1500R7	03080332	1.812	7.250	11.056	7.447	8.431	2.625	1.500	1.969	SPGX1504	SCGX150512
SD524-1875-750-1500R7	03080334	1.875	7.500	11.306	7.697	8.681	2.625	1.500	1.969	SPGX1504	SCGX150512
SD524-1937-775-1500R7	03080335	1.937	7.750	11.556	7.947	8.931	2.625	1.500	2.337	SPGX1504	SCGX150512
SD524-2000-800-1500R7	03080337	2.000	8.000	11.806	8.197	9.181	2.625	1.500	2.337	SPGX1504	SCGX150512

Wstęp

Wiercenie



Rozwiercanie

Wytaczanie

Załącznik

Oznaczenie	Numer produktu	DC	LU	OAL	LUX	LFS	LS	DMM	DF	Płytki	
		<i>Cal.</i>	<i>Cal.</i>	<i>Cal.</i>	<i>Cal.</i>	<i>Cal.</i>	<i>Cal.</i>	<i>Cal.</i>	<i>Cal.</i>	Płytki centralna	Płytki peryferyjna
SD524-2062-825-1500R7	03080339	2.062	8.250	12.056	8.447	9.431	2.625	1.500	2.337	SPGX1904	SCGX150512
SD524-2125-850-1500R7	03080342	2.125	8.500	12.306	8.697	9.681	2.625	1.500	2.337	SPGX1904	SCGX150512
SD524-2250-900-1500R7	03080346	2.250	9.000	12.806	9.197	10.181	2.625	1.500	2.337	SPGX1904	SCGX150512
SD524-2375-950-1500R7	03080349	2.375	9.500	13.306	9.697	10.681	2.625	1.500	2.480	SPGX1904	SCGX150512

Części zamienne, zawarte w dostawie

Dla śred. wiertła (cale)	Śruba do płytki centralnej	Śruba do płytki zewnętrznej	Klucz
			
0.594-0.687	C02245-T07P	C02245-T07P	T07P-2
0.709-0.766	C02205-T07P	C02245-T07P	T07P-2
0.787-0.827	C02205-T07P	C02205-T07P	T07P-2
0.875-0.905	C02506-T08P	C02506-T08P	T08P-2
0.906-1.000	C02507-T08P	C03007-T08P	T08P-2
1.032-1.109	C03007-T09P	C03007-T09P	T09P-2
1.125-1.187	C03007-T09P	C03009-T09P	T09P-2
1.250-1.562	C03508-T15P	C03508-T15P	T15P-2D
1.625-1.687	C03508-T15P	C05012-T15P	T15P-2D
1.750-2.375	C04011-T15P	C05012-T15P	T15P-2D

Akcesoria

Dla śred. wiertła (cale)	Klucz dynamometryczny
	
0.594-0.687	T00-07P09
0.709-0.766	T00-07P09
0.787-0.827	T00-07P09
0.875-0.905	T00-08P12
0.906-1.000	T00-08P12
1.032-1.109	T00-09P20
1.125-1.187	T00-09P20
1.250-1.562	T00-15P30
1.625-1.687	T00-15P30
1.750-2.375	T00-15P35

Klucz dynamometryczny wraz z wkładką.

SD524

Głębokość wiercenia ~ 4 x D – Calowe

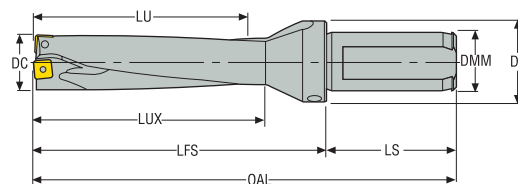

- Chwyt ISO 9766, R7-C
- Chłodzenie wewnętrzne
- Informacja na temat płytek patrz str. 292-298
- Parametry skrawania, patrz strona (strony) 303, 304
- Średnice pośrednie patrz aplikacja MyDesign.
- Do zastosowań stacjonarnych

Oznaczenie	Numer produktu	DC	LU	OAL	LUX	LFS	LS	DMM	DF	Płytki	
		Cal.	Cal.	Cal.	Cal.	Cal.	Cal.	Cal.	Cal.	Płytki centralna	Płytki peryferyjna
SD524-0625-250-1000R7-C	03080282	0.625	2.500	6.628	2.697	3.878	2.750	1.000	1.378	SPGX0502	SCGX050204
SD524-0687-275-1000R7-C	03080284	0.687	2.750	6.878	2.947	4.128	2.750	1.000	1.378	SCGX0502	SCGX050204
SD524-0750-300-1000R7-C	03080287	0.750	3.000	7.128	3.197	4.378	2.750	1.000	1.378	SPGX0602	SCGX050204
SD524-0812-325-1000R7-C	03080293	0.812	3.250	7.378	3.447	4.628	2.750	1.000	1.378	SPGX0602	SCGX060204
SD524-0875-350-1000R7-C	03080296	0.875	3.500	7.628	3.697	4.878	2.750	1.000	1.378	SPGX0703	SCGX060204
SD524-0937-375-1000R7-C	03080300	0.937	3.750	7.878	3.947	5.128	2.750	1.000	1.378	SPGX0703	SCGX070308
SD524-1000-400-1250R7-C	03080303	1.000	4.000	8.128	4.197	5.378	2.750	1.250	1.654	SPGX0703	SCGX070308
SD524-1062-425-1250R7-C	03080306	1.062	4.250	8.378	4.447	5.628	2.750	1.250	1.654	SPGX0903	SCGX070308
SD524-1125-450-1250R7-C	03080309	1.125	4.500	8.628	4.697	5.878	2.750	1.250	1.654	SPGX0903	SCGX09T308
SD524-1187-475-1250R7-C	03080312	1.187	4.750	8.878	4.947	6.128	2.750	1.250	1.654	SPGX0903	SCGX09T308
SD524-1250-500-1500R7-C	03080313	1.250	5.000	9.128	5.197	6.378	2.750	1.500	1.969	SPGX11T3	SCGX09T308
SD524-1312-525-1500R7-C	03080316	1.312	5.250	9.378	5.447	6.628	2.750	1.500	1.969	SPGX11T3	SCGX09T308
SD524-1375-550-1500R7-C	03080319	1.375	5.500	9.628	5.697	6.878	2.750	1.500	1.969	SPGX11T3	SCGX11T308
SD524-1500-600-1500R7-C	03080321	1.500	6.000	10.128	6.197	7.378	2.750	1.500	1.969	SPGX12T3	SCGX11T308
SD524-1750-700-1500R7-C	03080329	1.750	7.000	11.128	7.197	8.378	2.750	1.500	1.969	SPGX1504	SCGX120408
SD524-2000-800-1500R7-C	03080338	2.000	8.000	12.128	8.197	9.378	2.750	1.500	2.337	SPGX1504	SCGX150512
SD524-2125-850-1500R7-C	03080343	2.125	8.500	12.628	8.697	9.878	2.750	1.500	2.337	SPGX1904	SCGX150512
SD524-2250-900-1500R7-C	03080347	2.250	9.000	13.128	9.197	10.378	2.750	1.500	2.337	SPGX1904	SCGX150512
SD524-2375-950-1500R7-C	03080350	2.375	9.500	13.628	9.697	10.878	2.750	1.500	2.480	SPGX1904	SCGX150512

Części zamienne, zawarte w dostawie

Akcesoria

Dla śred. wiertła (cale)	Adapter przewodu	Śruba do płytki centralnej	Śruba do płytki zewnętrznej	Klucz	Zaślepka	Klucz dynamometryczny
0.625-0.687	1310	C02245-T07P	C02245-T07P	T07P-2	R1/4	T00-07P09
0.750	1310	C02205-T07P	C02245-T07P	T07P-2	R1/4	T00-07P09
0.812	1310	C02205-T07P	C02205-T07P	T07P-2	R1/4	T00-07P09
0.875	1310	C02506-T08P	C02506-T08P	T08P-2	R1/4	T00-08P12
0.937-1.000	1310	C02507-T08P	C03007-T08P	T08P-2	R1/4	T00-08P12
1.062	1310	C03007-T09P	C03007-T09P	T09P-2	R1/4	T00-09P20
1.125-1.187	1310	C03007-T09P	C03009-T09P	T09P-2	R1/4	T00-09P20
1.250-1.375	1310	C03508-T15P	C03508-T15P	T15P-2D	R1/4	T00-15P30
1.750-2.375	1310	C04011-T15P	C05012-T15P	T15P-2D	R1/4	T00-15P35

SD524

Głębokość wiercenia ~ 4 x D – Metryczne/Calowe

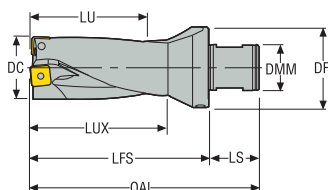

- Chwyt kompatybilny z ABS 50, -2
- Chłodzenie wewnętrzne
- Informacja na temat płytek patrz str. 292-298
- Parametry skrawania, patrz strona (strony) 303, 304
- Średnice pośrednie patrz aplikacja MyDesign.

Oznaczenie	Numer produktu	DC	LU	OAL	LUX	LFS	LS	DMM	DF	Płytki	
		mm Cal.	mm Cal.	mm Cal.	mm Cal.	mm Cal.	mm Cal.	mm Cal.	mm Cal.	Płytki centralna	Płytki peryferyjna
SD524-17-68-50R2	03080208	17,0 0.669	68,0 2.677	129,0 5.079	73,0 2.874	98,0 3.858	31,0 1.220	28,0 1.102	50,0 1.969	SPGX0502	SCGX050204
SD524-17.5-70-50R2	03080327	17,5 0.689	70,0 2.756	131,0 5.157	75,0 2.953	100,0 3.937	31,0 1.220	28,0 1.102	50,0 1.969	SPGX0602	SCGX050204
SD524-18-72-50R2	03080209	18,0 0.709	72,0 2.835	133,0 5.236	77,0 3.031	102,0 4.016	31,0 1.220	28,0 1.102	50,0 1.969	SPGX0602	SCGX050204
SD524-18.5-74-50R2	03080210	18,5 0.728	74,0 2.913	135,0 5.315	79,0 3.110	104,0 4.094	31,0 1.220	28,0 1.102	50,0 1.969	SPGX0602	SCGX050204
SD524-19-76-50R2	03080422	19,0 0.748	76,0 2.992	137,0 5.394	81,0 3.189	106,0 4.173	31,0 1.220	28,0 1.102	50,0 1.969	SPGX0602	SCGX050204
SD524-20-80-50R2	03080341	20,0 0.787	80,0 3.150	141,0 5.551	85,0 3.346	110,0 4.331	31,0 1.220	28,0 1.102	50,0 1.969	SPGX0602	SCGX060204
SD524-20.62-83-50R2	03080215	20,62 0.812	83,0 3.268	144,0 5.669	88,0 3.465	113,0 4.449	31,0 1.220	28,0 1.102	50,0 1.969	SPGX0602	SCGX060204
SD524-21-84-50R2	03080345	21,0 0.827	84,0 3.307	145,0 5.709	89,0 3.504	114,0 4.488	31,0 1.220	28,0 1.102	50,0 1.969	SPGX0602	SCGX060204
SD524-22-88-50R2	03080193	22,0 0.866	88,0 3.465	149,0 5.866	93,0 3.661	118,0 4.646	31,0 1.220	28,0 1.102	50,0 1.969	SPGX0703	SCGX060204
SD524-22.23-89-50R2	03080216	22,23 0.875	89,0 3.504	150,0 5.906	94,0 3.701	119,0 4.685	31,0 1.220	28,0 1.102	50,0 1.969	SPGX0703	SCGX060204
SD524-23-92-50R2	03080194	23,0 0.906	92,0 3.622	153,0 6.024	97,0 3.819	122,0 4.803	31,0 1.220	28,0 1.102	50,0 1.969	SPGX0703	SCGX070308
SD524-24-96-50R2	03080195	24,0 0.945	96,0 3.780	157,0 6.181	101,0 3.976	126,0 4.961	31,0 1.220	28,0 1.102	50,0 1.969	SPGX0703	SCGX070308
SD524-25-100-50R2	03080196	25,0 0.984	100,0 3.937	161,0 6.339	105,0 4.134	130,0 5.118	31,0 1.220	28,0 1.102	50,0 1.969	SPGX0703	SCGX070308
SD524-25.4-102-50R2	03080217	25,4 1.000	102,0 4.016	163,0 6.417	107,0 4.213	132,0 5.197	31,0 1.220	28,0 1.102	50,0 1.969	SPGX0703	SCGX070308
SD524-26-104-50R2	03080423	26,0 1.024	104,0 4.094	165,0 6.496	109,0 4.291	134,0 5.276	31,0 1.220	28,0 1.102	50,0 1.969	SPGX0903	SCGX070308
SD524-27-108-50R2	03080197	27,0 1.063	108,0 4.252	169,0 6.654	113,0 4.449	138,0 5.433	31,0 1.220	28,0 1.102	50,0 1.969	SPGX0903	SCGX070308
SD524-28-112-50R2	03080424	28,0 1.102	112,0 4.409	173,0 6.811	117,0 4.606	142,0 5.591	31,0 1.220	28,0 1.102	50,0 1.969	SPGX0903	SCGX070308
SD524-28.59-115-50R2	03080218	28,59 1.126	115,0 4.528	176,0 6.929	120,0 4.724	145,0 5.709	31,0 1.220	28,0 1.102	50,0 1.969	SPGX0903	SCGX070308
SD524-29-116-50R2	03080198	29,0 1.142	116,0 4.567	177,0 6.969	121,0 4.764	146,0 5.748	31,0 1.220	28,0 1.102	50,0 1.969	SPGX0903	SCGX09T308
SD524-30-120-50R2	03080199	30,0 1.181	120,0 4.724	181,0 7.126	125,0 4.921	150,0 5.906	31,0 1.220	28,0 1.102	50,0 1.969	SPGX0903	SCGX09T308
SD524-31-124-50R2	03080200	31,0 1.220	124,0 4.882	185,0 7.283	129,0 5.079	154,0 6.063	31,0 1.220	28,0 1.102	50,0 1.969	SPGX0903	SCGX09T308

Wstęp

Oznaczenie	Numer produktu	DC	LU	OAL	LUX	LFS	LS	DMM	DF	Płytki	
		mm Cal.	mm Cal.	mm Cal.	mm Cal.	mm Cal.	mm Cal.	mm Cal.	mm Cal.	Płytki centralna	Płytki peryferyjna
SD524-31.75-127-50R2	03080359	31,75 1.250	127,0 5.000	188,0 7.402	132,0 5.197	157,0 6.181	31,0 1.220	50,0 1.969	50,0 1.969	SPGX11T3	SCGX09T308
SD524-32-128-50R2	03080425	32,0 1.260	128,0 5.039	189,0 7.441	133,0 5.236	158,0 6.220	31,0 1.220	28,0 1.102	50,0 1.969	SPGX11T3	SCGX09T308
SD524-33-132-50R2	03080201	33,0 1.299	132,0 5.197	193,0 7.598	137,0 5.394	162,0 6.378	31,0 1.220	28,0 1.102	50,0 1.969	SPGX11T3	SCGX09T308
SD524-34-136-50R2	03080207	34,0 1.339	136,0 5.354	197,0 7.756	141,0 5.551	166,0 6.535	31,0 1.220	28,0 1.102	50,0 1.969	SPGX11T3	SCGX09T308
SD524-35-140-50R2	03080202	35,0 1.378	140,0 5.512	201,0 7.913	145,0 5.709	170,0 6.693	31,0 1.220	28,0 1.102	50,0 1.969	SPGX11T3	SCGX11T308
SD524-36-144-50R2	03080203	36,0 1.417	144,0 5.669	205,0 8.071	149,0 5.866	174,0 6.850	31,0 1.220	28,0 1.102	50,0 1.969	SPGX11T3	SCGX11T308
SD524-37-148-50R2	03080204	37,0 1.457	148,0 5.827	209,0 8.228	153,0 6.024	178,0 7.008	31,0 1.220	28,0 1.102	50,0 1.969	SPGX11T3	SCGX11T308
SD524-38-152-50R2	03080426	38,0 1.496	152,0 5.984	213,0 8.386	157,0 6.181	182,0 7.165	31,0 1.220	28,0 1.102	50,0 1.969	SPGX12T3	SCGX11T308
SD524-39-156-50R2	03080205	39,0 1.535	156,0 6.142	217,0 8.543	161,0 6.339	186,0 7.323	31,0 1.220	28,0 1.102	50,0 1.969	SPGX12T3	SCGX11T308
SD524-40-160-50R2	03080206	40,0 1.575	160,0 6.299	221,0 8.701	165,0 6.496	190,0 7.480	31,0 1.220	28,0 1.102	50,0 1.969	SPGX12T3	SCGX11T308



Wiercenie

Części zamienne, zawarte w dostawie

Dla śred. wiertła (mm)	Śruba mocująca płytkę		Klucz do płytek
			
	Płytki centralna	Płytki zewn.	
15,00-17,45	C02245-T07P	C02245-T07P	T07P-2
17,46-19,49	C02205-T07P	C02245-T07P	T07P-2
19,50-21,24	C02205-T07P	C02205-T07P	T07P-2
21,25-22,49	C02506-T08P	C02506-T08P	T08P-2
22,50-25,49	C02507-T08P	C03007-T08P	T08P-2
25,50-28,49	C03007-T09P	C03007-T09P	T09P-2
28,50-31,49	C03007-T09P	C03009-T09P	T09P-2
31,50-40,49	C03508-T15P	C03508-T15P	T15P-2D
40,50-43,24	C03508-T15P	C05012-T15P	T15P-2D
43,25-59,00	C04011-T15P	C05012-T15P	T15P-2D

Rozwiercanie

Akcesoria

Dla śred. wiertła (mm)	Klucz dynamometryczny*	Wkładka wymienna	Wielk. mom.
			
15,00-17,45	T00-07P09	T00-07P	0,9 Nm
17,46-19,49	T00-07P09	T00-07P	0,9 Nm
19,50-21,24	T00-07P09	T00-07P	0,9 Nm
21,25-22,49	T00-08P12	T00-08P	1,2 Nm
22,50-25,49	T00-08P12	T00-08P	1,2 Nm
25,50-28,49	T00-09P20	T00-09P	2,0 Nm
28,50-31,49	T00-09P20	T00-09P	2,0 Nm
31,50-40,49	T00-15P30	T00-15P	3,0 Nm
40,50-43,24	T00-15P30	T00-15P	3,0 Nm
43,25-59,00	T00-15P30	T00-15P	3,0 Nm

Wyłaczanie

Załącznik

*Zawiera płytkę.

SD524

Głębokość wiercenia ~ 4 x D – Metryczne/Calowe

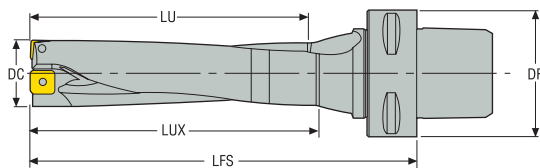



- Chwyt Seco-Capto™ C4
- Chłodzenie wewnętrzne
- Informacja na temat płytek patrz str. 292-298
- Parametry skrawania, patrz strona (strony) 303, 304
- Średnice pośrednie patrz aplikacja MyDesign.

Oznaczenie	Numer produktu	DC		LU		LUX		LFS		DF		Płytki	
		mm	Cal.	mm	Cal.	mm	Cal.	mm	Cal.	mm	Cal.	Płytki centralna	Płytki peryferyjna
SD524-17-68-C4	03080219	17,0	0.669	68,0	2.677	73,0	2.874	106,0	4.173	40,0	1.575	SPGX0502	SCGX050204
SD524-17.5-70-C4	03080220	17,5	0.689	70,0	2.756	75,0	2.953	109,0	4.291	40,0	1.575	SPGX0602	SCGX050204
SD524-18-72-C4	03080221	18,0	0.709	72,0	2.835	77,0	3.031	111,0	4.370	40,0	1.575	SPGX0602	SCGX050204
SD524-18.5-74-C4	03080222	18,5	0.728	74,0	2.913	79,0	3.110	113,0	4.449	40,0	1.575	SPGX0602	SCGX050204
SD524-19-76-C4	03080223	19,0	0.748	76,0	2.992	81,0	3.189	115,0	4.528	40,0	1.575	SPGX0602	SCGX050204
SD524-20-80-C4	03080224	20,0	0.787	80,0	3.150	85,0	3.346	121,0	4.764	40,0	1.575	SPGX0602	SCGX060204
SD524-20.62-83-C4	03080413	20,62	0.812	83,0	3.268	88,0	3.465	124,0	4.882	40,0	1.575	SPGX0602	SCGX060204
SD524-21-84-C4	03080225	21,0	0.827	84,0	3.307	89,0	3.504	125,0	4.921	40,0	1.575	SPGX0602	SCGX060204
SD524-22-88-C4	03080226	22,0	0.866	88,0	3.465	93,0	3.661	129,0	5.079	40,0	1.575	SPGX0703	SCGX060204
SD524-22.23-89-C4	03080414	22,23	0.875	89,0	3.504	94,0	3.701	130,0	5.118	40,0	1.575	SPGX0703	SCGX060204
SD524-23-92-C4	03080227	23,0	0.906	92,0	3.622	97,0	3.819	134,0	5.276	40,0	1.575	SPGX0703	SCGX070308
SD524-24-96-C4	03080228	24,0	0.945	96,0	3.780	101,0	3.976	139,0	5.472	40,0	1.575	SPGX0703	SCGX070308
SD524-25-100-C4	03080229	25,0	0.984	100,0	3.937	105,0	4.134	144,0	5.669	40,0	1.575	SPGX0703	SCGX070308
SD524-25.4-102-C4	03080415	25,4	1.000	102,0	4.016	107,0	4.213	146,0	5.748	40,0	1.575	SPGX0703	SCGX070308
SD524-26-104-C4	03080230	26,0	1.024	104,0	4.094	109,0	4.291	148,0	5.827	40,0	1.575	SPGX0903	SCGX070308
SD524-27-108-C4	03080231	27,0	1.063	108,0	4.252	113,0	4.449	152,0	5.984	40,0	1.575	SPGX0903	SCGX070308
SD524-28-112-C4	03080232	28,0	1.102	112,0	4.409	117,0	4.606	157,0	6.181	40,0	1.575	SPGX0903	SCGX070308
SD524-28.59-115-C4	03080416	28,59	1.126	115,0	4.528	120,0	4.724	160,0	6.299	40,0	1.575	SPGX0903	SCGX070308
SD524-29-116-C4	03080233	29,0	1.142	116,0	4.567	121,0	4.764	161,0	6.339	40,0	1.575	SPGX0903	SCGX09T308
SD524-30-120-C4	03080234	30,0	1.181	120,0	4.724	125,0	4.921	165,0	6.496	40,0	1.575	SPGX0903	SCGX09T308

Części zamienne, zawarte w dostawie

Dla śred. wiertła (mm)	Śruba mocująca płytkę		Klucz do płytek
			
	Płytki centralna	Płytki zewn.	
15,00-17,45	C02245-T07P	C02245-T07P	T07P-2
17,46-19,49	C02205-T07P	C02245-T07P	T07P-2
19,50-21,24	C02205-T07P	C02205-T07P	T07P-2
21,25-22,49	C02506-T08P	C02506-T08P	T08P-2
22,50-25,49	C02507-T08P	C03007-T08P	T08P-2
25,50-28,49	C03007-T09P	C03007-T09P	T09P-2
28,50-31,49	C03007-T09P	C03009-T09P	T09P-2
31,50-40,49	C03508-T15P	C03508-T15P	T15P-2D
40,50-43,24	C03508-T15P	C05012-T15P	T15P-2D
43,25-59,00	C04011-T15P	C05012-T15P	T15P-2D

Akcesoria

Dla śred. wiertła (mm)	Klucz dynamometryczny*	Wkładka wymienna	Wielk. mom.
			
15,00-17,45	T00-07P09	T00-07P	0,9 Nm
17,46-19,49	T00-07P09	T00-07P	0,9 Nm
19,50-21,24	T00-07P09	T00-07P	0,9 Nm
21,25-22,49	T00-08P12	T00-08P	1,2 Nm
22,50-25,49	T00-08P12	T00-08P	1,2 Nm
25,50-28,49	T00-09P20	T00-09P	2,0 Nm
28,50-31,49	T00-09P20	T00-09P	2,0 Nm
31,50-40,49	T00-15P30	T00-15P	3,0 Nm
40,50-43,24	T00-15P30	T00-15P	3,0 Nm
43,25-59,00	T00-15P30	T00-15P	3,0 Nm

*Zawiera płytkę.

SD524

Głębokość wiercenia ~ 4 x D – Metryczne/Calowe

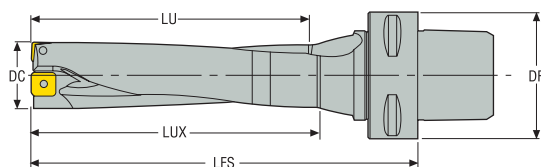

- Chwyt Seco-Capto™ C5
- Chłodzenie wewnętrzne
- Informacja na temat płytek patrz str. 292-298
- Parametry skrawania, patrz strona (strony) 303, 304
- Średnice pośrednie patrz aplikacja MyDesign.

Oznaczenie	Numer produktu	DC		LU		LUX		LFS		DF		Płytki	
		mm	Cal.	mm	Cal.	mm	Cal.	mm	Cal.	mm	Cal.	Płytki centralna	Płytki peryferyjna
SD524-17-68-C5	03080235	17,0	0.669	68,0	2.677	73,0	2.874	106,0	4.173	50,0	1.969	SPGX0502	SCGX050204
SD524-17.5-70-C5	03080237	17,5	0.689	70,0	2.756	75,0	2.953	109,0	4.291	50,0	1.969	SPGX0602	SCGX050204
SD524-18-72-C5	03080238	18,0	0.709	72,0	2.835	77,0	3.031	111,0	4.370	50,0	1.969	SPGX0602	SCGX050204
SD524-18.5-74-C5	03080239	18,5	0.728	74,0	2.913	79,0	3.110	113,0	4.449	50,0	1.969	SPGX0602	SCGX050204
SD524-19-76-C5	03080240	19,0	0.748	76,0	2.992	81,0	3.189	115,0	4.528	50,0	1.969	SPGX0602	SCGX050204
SD524-20-80-C5	03080241	20,0	0.787	80,0	3.150	85,0	3.346	121,0	4.764	50,0	1.969	SPGX0602	SCGX060204
SD524-20.62-83-C5	03080408	20,62	0.812	83,0	3.268	88,0	3.465	124,0	4.882	50,0	1.969	SPGX0602	SCGX060204
SD524-21-84-C5	03080242	21,0	0.827	84,0	3.307	89,0	3.504	125,0	4.921	50,0	1.969	SPGX0602	SCGX060204
SD524-22-88-C5	03080243	22,0	0.866	88,0	3.465	93,0	3.661	129,0	5.079	50,0	1.969	SPGX0703	SCGX060204
SD524-22.23-89-C5	03080409	22,23	0.875	89,0	3.504	94,0	3.701	130,0	5.118	50,0	1.969	SPGX0703	SCGX060204
SD524-23-92-C5	03080244	23,0	0.906	92,0	3.622	97,0	3.819	134,0	5.276	50,0	1.969	SPGX0703	SCGX070308
SD524-24-96-C5	03080245	24,0	0.945	96,0	3.780	101,0	3.976	139,0	5.472	50,0	1.969	SPGX0703	SCGX070308
SD524-25-100-C5	03080246	25,0	0.984	100,0	3.937	105,0	4.134	144,0	5.669	50,0	1.969	SPGX0703	SCGX070308
SD524-25.4-102-C5	03080410	25,4	1.000	102,0	4.016	107,0	4.213	146,0	5.748	50,0	1.969	SPGX0703	SCGX070308
SD524-26-104-C5	03080247	26,0	1.024	104,0	4.094	109,0	4.291	148,0	5.827	50,0	1.969	SPGX0903	SCGX070308
SD524-27-108-C5	03080248	27,0	1.063	108,0	4.252	113,0	4.449	152,0	5.984	50,0	1.969	SPGX0903	SCGX070308
SD524-28-112-C5	03080249	28,0	1.102	112,0	4.409	117,0	4.606	157,0	6.181	50,0	1.969	SPGX0903	SCGX070308
SD524-28.59-115-C5	03080411	28,59	1.126	115,0	4.528	120,0	4.724	160,0	6.299	50,0	1.969	SPGX0903	SCGX070308
SD524-29-116-C5	03080250	29,0	1.142	116,0	4.567	121,0	4.764	161,0	6.339	50,0	1.969	SPGX0903	SCGX09T308
SD524-30-120-C5	03080251	30,0	1.181	120,0	4.724	125,0	4.921	165,0	6.496	50,0	1.969	SPGX0903	SCGX09T308
SD524-31-124-C5	03080252	31,0	1.220	124,0	4.882	129,0	5.079	169,0	6.654	50,0	1.969	SPGX0903	SCGX09T308

Wstęp

Oznaczenie	Numer produktu	DC	LU	LUX	LFS	DF	Płytki	
		mm Cal.	mm Cal.	mm Cal.	mm Cal.	mm Cal.	Płytki centralna	Płytki peryferyjna
SD524-31.75-127-C5	03080412	31,75 1.250	127,0 5.000	132,0 5.197	173,0 6.811	50,0 1.969	SPGX11T3	SCGX09T308
SD524-32-128-C5	03080253	32,0 1.260	128,0 5.039	133,0 5.236	174,0 6.850	50,0 1.969	SPGX11T3	SCGX09T308
SD524-33-132-C5	03080254	33,0 1.299	132,0 5.197	137,0 5.394	178,0 7.008	50,0 1.969	SPGX11T3	SCGX09T308
SD524-34-136-C5	03080255	34,0 1.339	136,0 5.354	141,0 5.551	182,0 7.165	50,0 1.969	SPGX11T3	SCGX09T308
SD524-35-140-C5	03080256	35,0 1.378	140,0 5.512	145,0 5.709	186,0 7.323	50,0 1.969	SPGX11T3	SCGX11T308
SD524-36-144-C5	03080257	36,0 1.417	144,0 5.669	149,0 5.866	190,0 7.480	50,0 1.969	SPGX11T3	SCGX11T308
SD524-37-148-C5	03080258	37,0 1.457	148,0 5.827	153,0 6.024	194,0 7.638	50,0 1.969	SPGX11T3	SCGX11T308
SD524-38-152-C5	03080259	38,0 1.496	152,0 5.984	157,0 6.181	198,0 7.795	50,0 1.969	SPGX12T3	SCGX11T308
SD524-39-156-C5	03080260	39,0 1.535	156,0 6.142	161,0 6.339	202,0 7.953	50,0 1.969	SPGX12T3	SCGX11T308
SD524-40-160-C5	03080261	40,0 1.575	160,0 6.299	165,0 6.496	206,0 8.110	50,0 1.969	SPGX12T3	SCGX11T308



Wiercenie

Części zamienne, zawarte w dostawie

Dla śred. wiertła (mm)	Śruba mocująca płytkę		Klucz do płytek
			
	Płytki centralna	Płytki zewn.	
15,00-17,45	C02245-T07P	C02245-T07P	T07P-2
17,46-19,49	C02205-T07P	C02245-T07P	T07P-2
19,50-21,24	C02205-T07P	C02205-T07P	T07P-2
21,25-22,49	C02506-T08P	C02506-T08P	T08P-2
22,50-25,49	C02507-T08P	C03007-T08P	T08P-2
25,50-28,49	C03007-T09P	C03007-T09P	T09P-2
28,50-31,49	C03007-T09P	C03009-T09P	T09P-2
31,50-40,49	C03508-T15P	C03508-T15P	T15P-2D
40,50-43,24	C03508-T15P	C05012-T15P	T15P-2D
43,25-59,00	C04011-T15P	C05012-T15P	T15P-2D

Rozwiercanie

Akcesoria

Dla śred. wiertła (mm)	Klucz dynamometryczny*	Wkładka wymienna	Wielk. mom.
			
15,00-17,45	T00-07P09	T00-07P	0,9 Nm
17,46-19,49	T00-07P09	T00-07P	0,9 Nm
19,50-21,24	T00-07P09	T00-07P	0,9 Nm
21,25-22,49	T00-08P12	T00-08P	1,2 Nm
22,50-25,49	T00-08P12	T00-08P	1,2 Nm
25,50-28,49	T00-09P20	T00-09P	2,0 Nm
28,50-31,49	T00-09P20	T00-09P	2,0 Nm
31,50-40,49	T00-15P30	T00-15P	3,0 Nm
40,50-43,24	T00-15P30	T00-15P	3,0 Nm
43,25-59,00	T00-15P30	T00-15P	3,0 Nm

Wyłaczanie

Załącznik

*Zawiera płytkę.

SD524

Głębokość wiercenia ~ 4 x D – Metryczne/Calowe

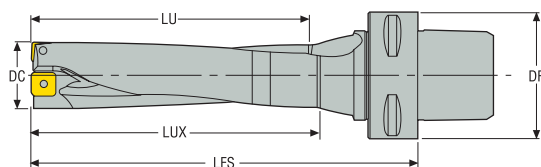

- Chwyt Seco-Capto™ C6
- Chłodzenie wewnętrzne
- Informacja na temat płytek patrz str. 292-298
- Parametry skrawania, patrz strona (strony) 303, 304
- Średnice pośrednie patrz aplikacja MyDesign.

Oznaczenie	Numer produktu	DC	LU	LUX	LFS	DF	Płytki	
		mm Cal.	mm Cal.	mm Cal.	mm Cal.	mm Cal.	Płytki centralna	Płytki peryferyjna
SD524-17-68-C6	03080262	17,0 0.669	68,0 2.677	73,0 2.874	108,0 4.252	63,0 2.480	SPGX0502	SCGX050204
SD524-17.5-70-C6	03080263	17,5 0.689	70,0 2.756	75,0 2.953	111,0 4.370	63,0 2.480	SPGX0602	SCGX050204
SD524-18-72-C6	03080265	18,0 0.709	72,0 2.835	77,0 3.031	113,0 4.449	63,0 2.480	SPGX0602	SCGX050204
SD524-18.5-74-C6	03080266	18,5 0.728	74,0 2.913	79,0 3.110	115,0 4.528	63,0 2.480	SPGX0602	SCGX050204
SD524-19-76-C6	03080267	19,0 0.748	76,0 2.992	81,0 3.189	117,0 4.606	63,0 2.480	SPGX0602	SCGX050204
SD524-20-80-C6	03080268	20,0 0.787	80,0 3.150	85,0 3.346	123,0 4.843	63,0 2.480	SPGX0602	SCGX060204
SD524-20.62-83-C6	03080417	20,62 0.812	83,0 3.268	88,0 3.465	126,0 4.961	63,0 2.480	SPGX0602	SCGX060204
SD524-21-84-C6	03080269	21,0 0.827	84,0 3.307	89,0 3.504	127,0 5.000	63,0 2.480	SPGX0602	SCGX060204
SD524-22-88-C6	03080270	22,0 0.866	88,0 3.465	93,0 3.661	131,0 5.157	63,0 2.480	SPGX0703	SCGX060204
SD524-22.23-89-C6	03080418	22,23 0.875	89,0 3.504	94,0 3.701	132,0 5.197	63,0 2.480	SPGX0703	SCGX060204
SD524-23-92-C6	03080271	23,0 0.906	92,0 3.622	97,0 3.819	136,0 5.354	63,0 2.480	SPGX0703	SCGX070308
SD524-24-96-C6	03080272	24,0 0.945	96,0 3.780	101,0 3.976	141,0 5.551	63,0 2.480	SPGX0703	SCGX070308
SD524-25-100-C6	03080392	25,0 0.984	100,0 3.937	105,0 4.134	146,0 5.748	63,0 2.480	SPGX0703	SCGX070308
SD524-25.4-102-C6	03080419	25,4 1.000	102,0 4.016	107,0 4.213	148,0 5.827	63,0 2.480	SPGX0703	SCGX070308
SD524-26-104-C6	03080393	26,0 1.024	104,0 4.094	109,0 4.291	150,0 5.906	63,0 2.480	SPGX0903	SCGX070308
SD524-27-108-C6	03080394	27,0 1.063	108,0 4.252	113,0 4.449	154,0 6.063	63,0 2.480	SPGX0903	SCGX070308
SD524-28-112-C6	03080395	28,0 1.102	112,0 4.409	117,0 4.606	159,0 6.260	63,0 2.480	SPGX0903	SCGX070308
SD524-28.59-115-C6	03080420	28,59 1.126	115,0 4.528	120,0 4.724	162,0 6.378	63,0 2.480	SPGX0903	SCGX070308
SD524-29-116-C6	03080396	29,0 1.142	116,0 4.567	121,0 4.764	163,0 6.417	63,0 2.480	SPGX0903	SCGX09T308
SD524-30-120-C6	03080397	30,0 1.181	120,0 4.724	125,0 4.921	167,0 6.575	63,0 2.480	SPGX0903	SCGX09T308
SD524-31-124-C6	03080398	31,0 1.220	124,0 4.882	129,0 5.079	171,0 6.732	63,0 2.480	SPGX0903	SCGX09T308

Wstęp

Oznaczenie	Numer produktu	DC	LU	LUX	LFS	DF	Płytki	
		mm Cal.	mm Cal.	mm Cal.	mm Cal.	mm Cal.	Płytki centralna	Płytki peryferyjna
SD524-31.75-127-C6	03080421	31,75 1.250	127,0 5.000	132,0 5.197	175,0 6.890	63,0 2.480	SPGX0903	SCGX09T308
SD524-32-128-C6	03080399	32,0 1.260	128,0 5.039	133,0 5.236	176,0 6.929	63,0 2.480	SPGX11T3	SCGX09T308
SD524-33-132-C6	03080400	33,0 1.299	132,0 5.197	137,0 5.394	180,0 7.087	63,0 2.480	SPGX11T3	SCGX09T308
SD524-34-136-C6	03080401	34,0 1.339	136,0 5.354	141,0 5.551	184,0 7.244	63,0 2.480	SPGX11T3	SCGX09T308
SD524-35-140-C6	03080402	35,0 1.378	140,0 5.512	145,0 5.709	188,0 7.402	63,0 2.480	SPGX11T3	SCGX11T308
SD524-36-144-C6	03080403	36,0 1.417	144,0 5.669	149,0 5.866	192,0 7.559	63,0 2.480	SPGX11T3	SCGX11T308
SD524-37-148-C6	03080404	37,0 1.457	148,0 5.827	153,0 6.024	196,0 7.717	63,0 2.480	SPGX11T3	SCGX11T308
SD524-38-152-C6	03080405	38,0 1.496	152,0 5.984	157,0 6.181	200,0 7.874	63,0 2.480	SPGX12T3	SCGX11T308
SD524-39-156-C6	03080406	39,0 1.535	156,0 6.142	161,0 6.339	204,0 8.031	63,0 2.480	SPGX12T3	SCGX11T308
SD524-40-160-C6	03080407	40,0 1.575	160,0 6.299	165,0 6.496	208,0 8.189	63,0 2.480	SPGX12T3	SCGX11T308



Wiercenie

Części zamienne, zawarte w dostawie

Dla śred. wiertła (mm)	Śruba mocująca płytkę		Klucz do płytek
			
	Płytki centralna	Płytki zewn.	
15,00-17,45	C02245-T07P	C02245-T07P	T07P-2
17,46-19,49	C02205-T07P	C02245-T07P	T07P-2
19,50-21,24	C02205-T07P	C02205-T07P	T07P-2
21,25-22,49	C02506-T08P	C02506-T08P	T08P-2
22,50-25,49	C02507-T08P	C03007-T08P	T08P-2
25,50-28,49	C03007-T09P	C03007-T09P	T09P-2
28,50-31,49	C03007-T09P	C03009-T09P	T09P-2
31,50-40,49	C03508-T15P	C03508-T15P	T15P-2D
40,50-43,24	C03508-T15P	C05012-T15P	T15P-2D
43,25-59,00	C04011-T15P	C05012-T15P	T15P-2D

Rozwiercanie

Akcesoria

Dla śred. wiertła (mm)	Klucz dynamometryczny*	Wkładka wymienna	Wielk. mom.
			
15,00-17,45	T00-07P09	T00-07P	0,9 Nm
17,46-19,49	T00-07P09	T00-07P	0,9 Nm
19,50-21,24	T00-07P09	T00-07P	0,9 Nm
21,25-22,49	T00-08P12	T00-08P	1,2 Nm
22,50-25,49	T00-08P12	T00-08P	1,2 Nm
25,50-28,49	T00-09P20	T00-09P	2,0 Nm
28,50-31,49	T00-09P20	T00-09P	2,0 Nm
31,50-40,49	T00-15P30	T00-15P	3,0 Nm
40,50-43,24	T00-15P30	T00-15P	3,0 Nm
43,25-59,00	T00-15P30	T00-15P	3,0 Nm

Wyłaczanie

Załącznik

*Zawiera płytkę.

SD525

Głębokość wiercenia ~ 5 x D – Metryczne/Calowe

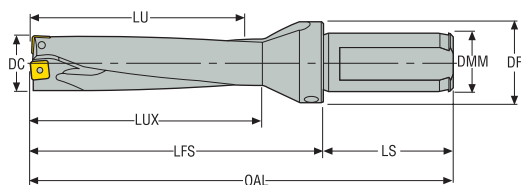



- Chwył ISO 9766, -7
- Chłodzenie wewnętrzne
- Informacja na temat płytek patrz str. 292-298
- Parametry skrawania, patrz strona (strony) 305, 306
- Średnice pośrednie patrz aplikacja MyDesign.



Oznaczenie	Numer produktu	DC	LU	OAL	LUX	LFS	LS	DMM	DF	Płytki	
		mm Cal.	mm Cal.	mm Cal.	mm Cal.	mm Cal.	mm Cal.	mm Cal.	mm Cal.	Płytki centralna	Płytki peryferyjna
SD525-19-95-25R7	03079580	19,0 0.748	95,0 3.740	181,0 7.126	100,0 3.937	125,0 4.921	56,0 2.205	25,0 0.984	35,0 1.378	SPGX0602	SCGX050204
SD525-20-100-25R7	03079582	20,0 0.787	100,0 3.937	186,0 7.323	105,0 4.134	130,0 5.118	56,0 2.205	25,0 0.984	35,0 1.378	SPGX0602	SCGX060204
SD525-21-105-25R7	03079583	21,0 0.827	105,0 4.134	191,0 7.520	110,0 4.331	135,0 5.315	56,0 2.205	25,0 0.984	35,0 1.378	SPGX0602	SCGX060204
SD525-22-110-25R7	03079584	22,0 0.866	110,0 4.331	196,0 7.717	115,0 4.528	140,0 5.512	56,0 2.205	25,0 0.984	35,0 1.378	SPGX0703	SCGX060204
SD525-23-115-25R7	03079585	23,0 0.906	115,0 4.528	201,0 7.913	120,0 4.724	145,0 5.709	56,0 2.205	25,0 0.984	35,0 1.378	SPGX0703	SCGX070308
SD525-24-120-25R7	03079586	24,0 0.945	120,0 4.724	206,0 8.110	125,0 4.921	150,0 5.906	56,0 2.205	25,0 0.984	35,0 1.378	SPGX0703	SCGX070308
SD525-25-125-32R7	03079587	25,0 0.984	125,0 4.921	215,0 8.465	130,0 5.118	155,0 6.102	60,0 2.362	32,0 1.260	42,0 1.654	SPGX0703	SCGX070308
SD525-26-130-32R7	03079588	26,0 1.024	130,0 5.118	220,0 8.661	135,0 5.315	160,0 6.299	60,0 2.362	32,0 1.260	42,0 1.654	SPGX0903	SCGX070308
SD525-27-135-32R7	03079589	27,0 1.063	135,0 5.315	225,0 8.858	140,0 5.512	165,0 6.496	60,0 2.362	32,0 1.260	42,0 1.654	SPGX0903	SCGX070308
SD525-28-140-32R7	03079590	28,0 1.102	140,0 5.512	230,0 9.055	145,0 5.709	170,0 6.693	60,0 2.362	32,0 1.260	42,0 1.654	SPGX0903	SCGX070308
SD525-29-145-32R7	03079591	29,0 1.142	145,0 5.709	235,0 9.252	150,0 5.906	175,0 6.890	60,0 2.362	32,0 1.260	42,0 1.654	SPGX0903	SCGX09T308
SD525-30-150-32R7	03079592	30,0 1.181	150,0 5.906	240,0 9.449	155,0 6.102	180,0 7.087	60,0 2.362	32,0 1.260	42,0 1.654	SPGX0903	SCGX09T308
SD525-31-155-32R7	03079593	31,0 1.220	155,0 6.102	245,0 9.646	160,0 6.299	185,0 7.283	60,0 2.362	32,0 1.260	42,0 1.654	SPGX0903	SCGX09T308
SD525-32-160-40R7	03079595	32,0 1.260	160,0 6.299	258,0 10.157	165,0 6.496	190,0 7.480	68,0 2.677	40,0 1.575	50,0 1.969	SPGX11T3	SCGX09T308
SD525-33-165-40R7	03079596	33,0 1.299	165,0 6.496	263,0 10.354	170,0 6.693	195,0 7.677	68,0 2.677	40,0 1.575	50,0 1.969	SPGX11T3	SCGX09T308
SD525-34-170-40R7	03079597	34,0 1.339	170,0 6.693	268,0 10.551	175,0 6.890	200,0 7.874	68,0 2.677	40,0 1.575	50,0 1.969	SPGX11T3	SCGX09T308
SD525-35-175-40R7	03079598	35,0 1.378	175,0 6.890	273,0 10.748	180,0 7.087	205,0 8.071	68,0 2.677	40,0 1.575	50,0 1.969	SPGX11T3	SCGX11T308
SD525-36-180-40R7	03079599	36,0 1.417	180,0 7.087	278,0 10.945	185,0 7.283	210,0 8.268	68,0 2.677	40,0 1.575	50,0 1.969	SPGX11T3	SCGX11T308
SD525-37-185-40R7	03079600	37,0 1.457	185,0 7.283	283,0 11.142	190,0 7.480	215,0 8.465	68,0 2.677	40,0 1.575	50,0 1.969	SPGX11T3	SCGX11T308
SD525-38-190-40R7	03079601	38,0 1.496	190,0 7.480	288,0 11.339	195,0 7.677	220,0 8.661	68,0 2.677	40,0 1.575	50,0 1.969	SPGX12T3	SCGX11T308
SD525-39-195-40R7	03079602	39,0 1.535	195,0 7.677	293,0 11.535	200,0 7.874	225,0 8.858	68,0 2.677	40,0 1.575	50,0 1.969	SPGX12T3	SCGX11T308

Oznaczenie	Numer produktu	DC	LU	OAL	LUX	LFS	LS	DMM	DF	Płytki	
		mm Cal.	mm Cal.	mm Cal.	mm Cal.	mm Cal.	mm Cal.	mm Cal.	mm Cal.	Płytki centralna	Płytki peryferyjna
SD525-40-200-40R7	03079603	40,0 1.575	200,0 7.874	298,0 11.732	205,0 8.071	230,0 9.055	68,0 2.677	40,0 1.575	50,0 1.969	SPGX12T3	SCGX11T308
SD525-41-205-40R7	03079604	41,0 1.614	205,0 8.071	303,0 11.929	210,0 8.268	235,0 9.252	68,0 2.677	40,0 1.575	50,0 1.969	SPGX12T3	SCGX120408
SD525-42-210-40R7	03079605	42,0 1.654	210,0 8.268	308,0 12.126	215,0 8.465	240,0 9.449	68,0 2.677	40,0 1.575	50,0 1.969	SPGX12T3	SCGX120408
SD525-43-215-40R7	03079606	43,0 1.693	215,0 8.465	313,0 12.323	220,0 8.661	245,0 9.646	68,0 2.677	40,0 1.575	50,0 1.969	SPGX12T3	SCGX120408
SD525-44-220-40R7	03079607	44,0 1.732	220,0 8.661	318,0 12.520	225,0 8.858	250,0 9.843	68,0 2.677	40,0 1.575	50,0 1.969	SPGX1504	SCGX120408
SD525-45-225-40R7	03079608	45,0 1.772	225,0 8.858	323,0 12.717	230,0 9.055	255,0 10.039	68,0 2.677	40,0 1.575	50,0 1.969	SPGX1504	SCGX150512

Części zamienne, zawarte w dostawie

Dla śred. wiertła (mm)	Śruba mocująca płytkę		Klucz do płytek
			
	Płytki centralna	Płytki zewn.	
15,00-17,45	C02245-T07P	C02245-T07P	T07P-2
17,46-19,49	C02205-T07P	C02245-T07P	T07P-2
19,50-21,24	C02205-T07P	C02205-T07P	T07P-2
21,25-22,49	C02506-T08P	C02506-T08P	T08P-2
22,50-25,49	C02507-T08P	C03007-T08P	T08P-2
25,50-28,49	C03007-T09P	C03007-T09P	T09P-2
28,50-31,49	C03007-T09P	C03009-T09P	T09P-2
31,50-40,49	C03508-T15P	C03508-T15P	T15P-2D
40,50-43,24	C03508-T15P	C05012-T15P	T15P-2D
43,25-59,00	C04011-T15P	C05012-T15P	T15P-2D

Akcesoria

Dla śred. wiertła (mm)	Klucz dynamometryczny*	Wkładka wymienna	Wielk. mom.
			
15,00-17,45	T00-07P09	T00-07P	0,9 Nm
17,46-19,49	T00-07P09	T00-07P	0,9 Nm
19,50-21,24	T00-07P09	T00-07P	0,9 Nm
21,25-22,49	T00-08P12	T00-08P	1,2 Nm
22,50-25,49	T00-08P12	T00-08P	1,2 Nm
25,50-28,49	T00-09P20	T00-09P	2,0 Nm
28,50-31,49	T00-09P20	T00-09P	2,0 Nm
31,50-40,49	T00-15P30	T00-15P	3,0 Nm
40,50-43,24	T00-15P30	T00-15P	3,0 Nm
43,25-59,00	T00-15P30	T00-15P	3,0 Nm

*Zawiera płytkę.

SD525

Głębokość wiercenia ~ 5 x D – Calowe

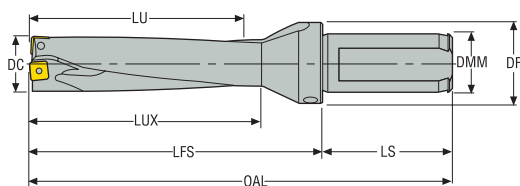

- Chwyt ISO 9766, -7
- Chłodzenie wewnętrzne
- Informacja na temat płytek patrz str. 292-298
- Parametry skrawania, patrz strona (strony) 305, 306
- Średnice pośrednie patrz aplikacja MyDesign.

Oznaczenie	Numer produktu	DC	LU	OAL	LUX	LFS	LS	DMM	DF	Płytki	
		Cal.	Cal.	Cal.	Cal.	Cal.	Cal.	Cal.	Cal.	Płytki centralna	Płytki peryferyjna
SD525-0750-375-1000R7	03079565	0.750	3.750	7.181	3.947	4.931	2.250	1.000	1.378	SPGX0602	SCGX050204
SD525-0812-406-1000R7	03079566	0.812	4.060	7.491	4.257	5.241	2.250	1.000	1.378	SPGX0602	SCGX060204
SD525-0875-438-1000R7	03079567	0.875	4.380	7.811	4.577	5.561	2.250	1.000	1.378	SPGX0703	SCGX060204
SD525-0937-469-1000R7	03079568	0.937	4.690	8.121	4.887	5.871	2.250	1.000	1.378	SPGX0703	SCGX070308
SD525-1000-500-1250R7	03079569	1.000	5.000	8.556	5.197	6.181	2.375	1.250	1.654	SPGX0703	SCGX070308
SD525-1062-531-1250R7	03079570	1.062	5.310	8.866	5.507	6.491	2.375	1.250	1.654	SPGX0903	SCGX070308
SD525-1125-563-1250R7	03079571	1.125	5.630	9.186	5.827	6.811	2.375	1.250	1.654	SPGX0903	SCGX09T308
SD525-1187-594-1250R7	03079572	1.187	5.940	9.496	6.137	7.121	2.375	1.250	1.654	SPGX0903	SCGX09T308
SD525-1250-625-1500R7	03079573	1.250	6.250	10.056	6.447	7.431	2.625	1.500	1.969	SPGX11T3	SCGX09T308
SD525-1375-687-1500R7	03079574	1.375	6.870	10.676	7.067	8.051	2.625	1.500	1.969	SPGX11T3	SCGX11T308
SD525-1500-750-1500R7	03079575	1.500	7.500	11.306	7.697	8.681	2.625	1.500	1.969	SPGX12T3	SCGX11T308
SD525-1625-812-1500R7	03079576	1.625	8.120	11.926	8.317	9.301	2.625	1.500	1.969	SPGX12T3	SCGX120408
SD525-1750-875-1500R7	03079577	1.750	8.750	12.556	8.947	9.931	2.625	1.500	1.969	SPGX1504	SCGX120408
SD525-1875-937-1500R7	03079578	1.875	9.370	13.176	9.567	10.551	2.625	1.500	1.969	SPGX1504	SCGX150512
SD525-1937-968-1500R7	03079579	1.937	9.680	13.486	9.877	10.861	2.625	1.500	2.337	SPGX1504	SCGX150512
SD525-2000-1000-1500R7	03079581	2.000	10.000	13.806	10.197	11.181	2.625	1.500	2.337	SPGX1504	SCGX150512

Części zamienne, zawarte w dostawie

Akcesoria

Dla śred. wiertła (cale)	Śruba do płytki centralnej	Śruba do płytki zewnętrznej	Klucz	Klucz dynamometryczny
0.750	C02205-T07P	C02245-T07P	T07P-2	T00-07P09
0.812	C02205-T07P	C02205-T07P	T07P-2	T00-07P09
0.875	C02506-T08P	C02506-T08P	T08P-2	T00-08P12
0.937-1.000	C02507-T08P	C03007-T08P	T08P-2	T00-08P12
1.062	C03007-T09P	C03007-T09P	T09P-2	T00-09P20
1.125-1.187	C03007-T09P	C03009-T09P	T09P-2	T00-09P20
1.250-1.500	C03508-T15P	C03508-T15P	T15P-2D	T00-15P30
1.625	C03508-T15P	C05012-T15P	T15P-2D	T00-15P30
1.750-2.000	C04011-T15P	C05012-T15P	T15P-2D	T00-15P35

SD542

Głębokość wiercenia ~ 2,5 x D – Metryczne

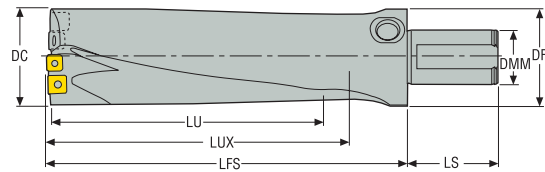

- Chwył ISO 9766, -7
- Chłodzenie wewnętrzne
- Informacja na temat płytek patrz str. 292-298
- Parametry skrawania, patrz strona (strony) 307, 308
- Średnice pośrednie patrz aplikacja MyDesign.

Oznaczenie	Numer produktu	DC	LU	LUX	LFS	LS	DMM	DF	Płytki	
		mm	mm	mm	mm	mm	mm	mm	Płytki centralna	Płytki peryferyjna
SD542-60-150-40R7	02590456	60,0	150,0	156,0	201,5	68,0	40,0	79,0	SPGX0903-C1	SCGX09T308..
SD542-65-162.5-40R7	02590457	65,0	162,5	169,5	214,0	68,0	40,0	79,0	SPGX11T3-C1	SCGX09T308..
SD542-70-175-40R7	02590458	70,0	175,0	182,5	226,5	68,0	40,0	79,0	SPGX11T3-C1	SCGX120408..
SD542-75-187.5-50R7	02590459	75,0	187,5	196,0	239,0	78,0	50,0	79,0	SPGX11T3-C1	SCGX120408..
SD542-80-200-50R7	02590460	80,0	200,0	210,0	251,5	78,0	50,0	79,0	SPGX12T3-C1	SCGX120408..
SD542-85-212.5-50R7	02590461	85,0	212,5	221,0	264,0	78,0	50,0	89,0	SPGX12T3-C1	SCGX120408..

Części zamienne, zawarte w dostawie

Dla śred. wiertła (mm)	Śruba mocująca płytkę	Klucz do płytek	Zaślepka	Adapter przewodu
	Płytki centralna	Płytki zewn.		
60,00-64,99	C03007-T09P	C03009-T09P	T09P-2	R3/8
65,00-68,99	C03508-T15P	C03508-T15P	T15P-2D	R3/8
69,00-86,99	C03508-T15P	C05012-T15P	T15P-2D	R3/8

Akcesoria

Dla śred. wiertła (mm)	Klucz dynamometryczny*	Wkładka wymienna	Wielk. mom.
15,00-17,45	T00-09P20	T00-09P	3,0 Nm
17,46-19,49	T00-15P30	T00-15P	3,0 Nm
19,50-21,24	T00-15P30	T00-15P	3,0 Nm

*Zawiera płytkę.

SD542



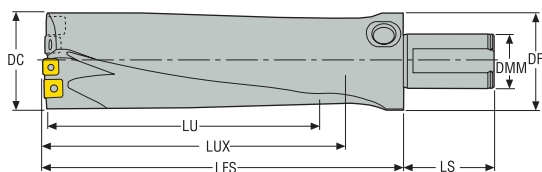

Głębokość wiercenia ~ 2.5 X D – Calowe





- Chwył ISO 9766, -7
- Chłodzenie wewnętrzne
- Informacja na temat płytek patrz str. 292-298
- Parametry skrawania, patrz strona (strony) 307, 308
- Średnice pośrednie patrz aplikacja MyDesign.

Oznaczenie	Numer produktu	DC	LU	LUX	LFS	LS	DMM	DF	Płytki	
		Cal.	Cal.	Cal.	Cal.	Cal.	Cal.	Cal.	Płytki centralna	Płytki peryferyjna
SD542-2250-563-1500R7	02602085	2.250	5.630	5.800	7.000	4.500	1.500	3.110	SPGX 0903-C1	SCGX 09T308..
SD542-2500-625-1500R7	02602087	2.500	6.250	6.520	8.280	4.500	1.500	3.110	SPGX 0903-C1	SCGX 09T308..
SD542-2750-688-1500R7	02602088	2.750	6.880	7.190	8.900	4.500	1.500	3.110	SPGX 11T3-C1	SCGX 120408..
SD542-3000-750-2000R7	02602089	3.000	7.500	7.860	9.530	4.500	2.000	3.110	SPGX 11T3-C1	SCGX 120408..
SD542-3250-813-2500R7	02602090	3.250	8.130	8.460	10.150	4.500	2.500	3.500	SPGX 12T3-C1	SCGX 120408..
SD542-3500-875-2500R7	02602091	3.500	8.750	9.140	10.780	4.500	2.500	3.500	SPGX 1504-C1	SCGX 120408..

Części zamienne, zawarte w dostawie

Dla śred. wiertła (mm)	Śruba mocująca płytkę		Klucz do płytek	Zaślepka	Adapter przewodu
					
	Płytki centralna	Płytki zewn.			
60,00-64,99	C03007-T09P	C03009-T09P	T09P-2	R3/8	R3/8-HA
65,00-68,99	C03508-T15P	C03508-T15P	T15P-2D	R3/8	R3/8-HA
69,00-86,99	C03508-T15P	C05012-T15P	T15P-2D	R3/8	R3/8-HA

Akcesoria

Dla śred. wiertła (mm)	Klucz dynamometryczny*	Wkładka wymienna	Wielk. mom.
			
15,00-17,45	T00-09P20	T00-09P	3,0 Nm
17,46-19,49	T00-15P30	T00-15P	3,0 Nm
19,50-21,24	T00-15P30	T00-15P	3,0 Nm

*Zawiera płytkę.

SD572

Głębokość wiercenia ~ 2 x D – Metryczne

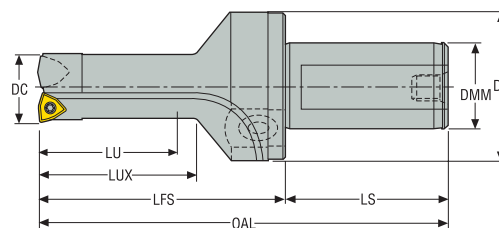



- Chwyt ISO 9766, -7
- Chłodzenie wewnętrzne
- Informacja na temat płytek patrz str. 292-298
- Parametry skrawania, patrz strona (strony) 309-310
- Średnice pośrednie patrz aplikacja MyDesign.

Oznaczenie	Numer produktu	DC	LU	LUX	LFS	LS	DMM	DF	Płytki	
									Płytki centralna	Płytki peryferyjna
SD572-15-30-25R7	02595777	15,0	30,0	35,0	65,0	56,0	25,0	42,0	WCMX030208-86	WCMX030208..
SD572-16-32-25R7	02595778	16,0	32,0	37,0	67,0	56,0	25,0	42,0	WCMX030208-86	WCMX030208..
SD572-17-34-25R7	02595779	17,0	34,0	39,0	69,0	56,0	25,0	42,0	WCMX030208-86	WCMX030208..
SD572-19-38-25R7	02595780	19,0	38,0	43,0	73,0	56,0	25,0	42,0	WCMX040208-86	WCMX030208..
SD572-22-44-25R7	02595781	22,0	44,0	49,0	79,0	56,0	25,0	42,0	WCMX050308-86	WCMX040208..
SD572-27-54-32R7	02595783	27,0	54,0	59,0	89,0	60,0	32,0	50,0	WCMX06T308-86	WCMX050308..
SD572-33-66-40R7	02595784	33,0	66,0	71,0	101,0	68,0	40,0	59,0	WCMX080412-86	WCMX06T308..
SD572-41-82-40R7	02595785	41,0	82,0	87,0	117,0	68,0	40,0	59,0	WCMX080412-86	WCMX080412..
SD572-47-94-40R7	02595786	47,0	94,0	99,0	129,0	68,0	40,0	59,0	WCMX080412-86	WCMX080412..

Części zamienne, zawarte w dostawie

Dla śred. wiertła (mm)	Śruba mocująca płytkę		Klucz do płytek	Zaślepka	Adapter przewodu
	Płytki centralna	Płytki zewn.			
15,00-20,50	C02205-T07P	C02205-T07P	T07P-2	R1/4	1310
20,51-24,50	C03007-T08P	C02506-T08P	T08P-2	R1/4	1310
24,51-32,50	C03508-T15P	C03007-T08P	T08P-2, T15P-2D	R1/4	1310
32,51-36,50	C03508-T15P	C03508-T15P	T15P-2D	R1/4	1310
36,51-59,00	C04011-T15P	C04011-T15P	T15P-2D	R1/4	1310

Akcesoria

Dla śred. wiertła (mm)	Klucz dynamometryczny*	Wkładka wymienna	Wielk. mom.
			
15,00-20,50	T00-07P09	T00-07P	0,9 Nm
20,51-24,50	T00-08P12	T00-08P	1,2 Nm
24,51-32,50	T00-08P12	T00-08P	1,2 Nm
32,51-36,50	T00-15P30	T00-15P	3,0 Nm
36,51-59,00	T00-15P30	T00-15P	3,0 Nm

*Zawiera płytkę.

SD572

Głębokość wiercenia ~ 2 x D – Calowe

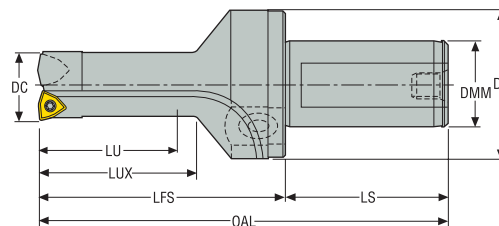

- Chwył ISO 9766, -7
- Chłodzenie wewnętrzne
- Informacja na temat płytek patrz str. 292-298
- Parametry skrawania, patrz strona (strony) 309-310
- Średnice pośrednie patrz aplikacja MyDesign.

Oznaczenie	Numer produktu	Srednica otworu min-maks.	DC	LU	LUX	LFS	DF	Płytki	
		(cale)						Płytki centralna	Płytki periferyjna
SD572-0591-118-1000R7	02602128	0.591—	0.591	1.182	1.379	2.56	1.775	WCMX030208-86	WCMX 030208..
SD572-0669-134-1000R7	02602129	0.669—	0.669	1.338	1.535	2.716	1.775	WCMX030208-86	WCMX 030208..
SD572-0748-150-1000R7	02602131	0.748—	0.748	1.496	1.69	2.874	1.775	WCMX040208-86	WCMX 030208..
SD572-0866-173-1000R7	02602132	0.866—	0.866	1.732	1.929	3.11	1.775	WCMX050308-86	WCMX 040208..
SD572-1062-212-1250R7	02602133	1.062—	1.062	2.124	2.321	3.502	2.165	WCMX06T308-86	WCMX 050308..
SD572-1299-260-1500R7	02602134	1.299—	1.299	2.598	2.795	3.976	2.303	WCMX080412-86	WCMX 06T308..
SD572-1614-322-1500R7	02602135	1.614—	1.614	3.228	3.425	4.606	2.303	WCMX080412-86	WCMX 080412..
SD572-1850-370-1500R7	02602136	1.850—	1.85	3.7	3.7	5.078	2.303	WCMX080412-86	WCMX 080412..

Części zamienne, zawarte w dostawie

Dla śred. wiertła (cale)	Adapter przewodu	Klucz do płytki	Śruba do płytki centralnej	Śruba do płytki zewnętrznej	Klucz (Typu flaga)	Śruba
0.591-0.748	1310	T07P-2	C02205-T07P	C02245-T07P	C02245-T07P	R1/4
0.866	1310	T08P-2	C02506-T08P	C03007-T08P	-	R1/4
1.062	1310	T08P-2	C03508-T15P	C03007-T08P	T15P-2D	R1/4
1.299	1310	T15P-2D	C03508-T15P	C02506-T08P	C02506-T08P	R1/4
1.614-1.850	1310	T15P-2D	C04011-T15P	C04011-T15P	-	R1/4

Akcesoria

Dla śred. wiertła (cale)	Wkładka do wymiany	Klucz dynamometryczny
0.591-0.748	-	T00-07P09
0.866	-	T00-08P12
1.062	T00-15P	T00-15P30
1.299	-	T00-15P30
1.614-1.850	-	T00-15P30

SD572

Głębokość wiercenia ~ 2 x D – Metryczne

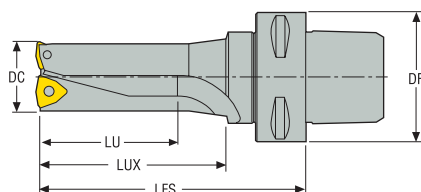

- Chwyt Seco-Capto™ C5
- Chłodzenie wewnętrzne
- Informacja na temat płytek patrz str. 292-298
- Parametry skrawania, patrz strona (strony) 309-310
- Średnice pośrednie patrz aplikacja MyDesign.

Oznaczenie	Numer produktu	Minm. śred. otworu-maks. (mm)	DC	LU	LUX	LFS	DF	Płytki	
		mm						Płytki centralna	Płytki peryferyjna
SD572-15-30-C5	02595831	14,8-18,0	15,0	30,0	35,0	85,0	50,0	WCMX030208-86	WCMX030208..
SD572-16-32-C5	02595832	15,8-18,0	16,0	32,0	37,0	87,0	50,0	WCMX030208-86	WCMX030208..
SD572-17-34-C5	02595833	16,8-19,0	17,0	34,0	39,0	89,0	50,0	WCMX030208-86	WCMX030208..
SD572-19-38-C5	02595834	18,8-22,0	19,0	38,0	43,0	93,0	50,0	WCMX040208-86	WCMX030208..
SD572-22-44-C5	02595835	21,8-27,0	22,0	44,0	49,0	99,0	50,0	WCMX050308-86	WCMX040208..
SD572-27-54-C5	02595836	26,8-33,0	27,0	54,0	59,0	109,0	50,0	WCMX06T308-86	WCMX050308..
SD572-33-66-C5	02595837	32,8-41,0	33,0	66,0	71,0	121,0	50,0	WCMX080412-86	WCMX06T308..
SD572-41-82-C5	02595838	40,8-47,0	41,0	82,0	87,0	157,0	50,0	WCMX080412-86	WCMX080412..
SD572-47-94-C5	02595839	46,8-52,0	47,0	94,0	99,0	169,0	50,0	WCMX080412-86	WCMX080412..

Części zamienne, zawarte w dostawie

Dla śred. wiertła (mm)	Śruba mocująca płytkę	Klucz do płytek	Zaślepka	Adapter przewodu	
	Płytki centralna	Płytki zewn.			
15,00-20,50	C02205-T07P	C02205-T07P	T07P-2	R1/4	1310
20,51-24,50	C03007-T08P	C02506-T08P	T08P-2	R1/4	1310
24,51-32,50	C03508-T15P	C03007-T08P	T08P-2, T15P-2D	R1/4	1310
32,51-36,50	C03508-T15P	C03508-T15P	T15P-2D	R1/4	1310
36,51-59,00	C04011-T15P	C04011-T15P	T15P-2D	R1/4	1310

Akcesoria

Dla śred. wiertła (mm)	Klucz dynamometryczny*	Wkładka wymienna	Wielk. mom.
15,00-20,50	T00-07P09	T00-07P	0,9 Nm
20,51-24,50	T00-08P12	T00-08P	1,2 Nm
24,51-32,50	T00-08P12	T00-08P	1,2 Nm
32,51-36,50	T00-15P30	T00-15P	3,0 Nm
36,51-59,00	T00-15P30	T00-15P	3,0 Nm

*Zawiera płytkę.



Perfomax® SD602

Perfomax® SD602 to modułowy system głowicy wierzącej zaprojektowany z myślą o wierceniu głębokich otworów, gdy wymagana jest bezpieczna i wydajna obróbka przy dużych średnicach.

- Gatunek DP3000 zapewnia wytrzymałość wymaganą do optymalizacji Perfomax® SD602
- Umożliwia duże posuwy i prędkości obróbki
- Wysoka uniwersalność dzięki zastosowaniu przedłużeń pozwala uzyskać wymaganą głębokość wiercenia

Oznaczenia

Korpusy wiertel

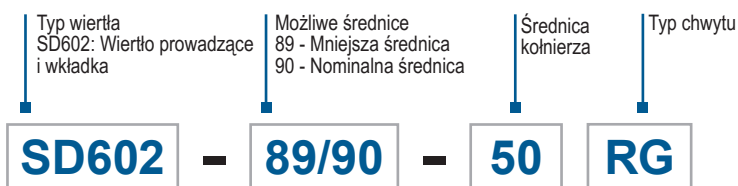

Wiertło prowadzące

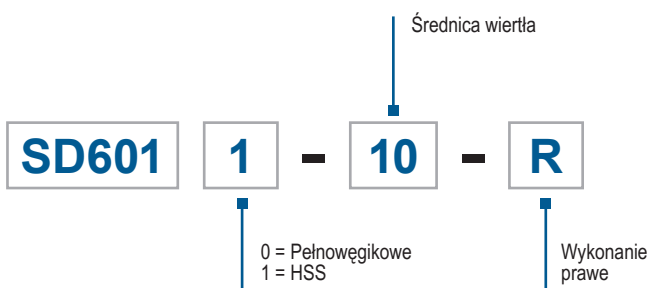

(Wiertło prowadzące należy zakupić osobno)

Kaseta

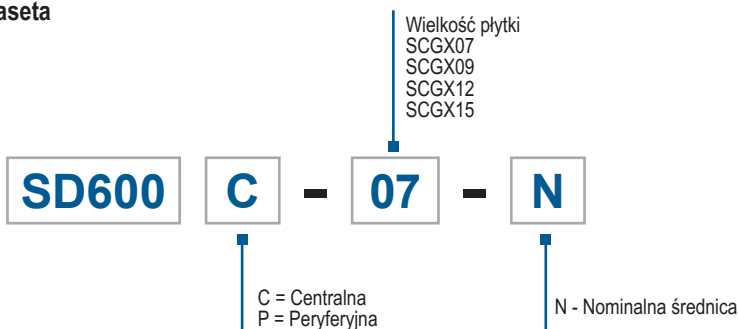

-N



-U

Zestaw

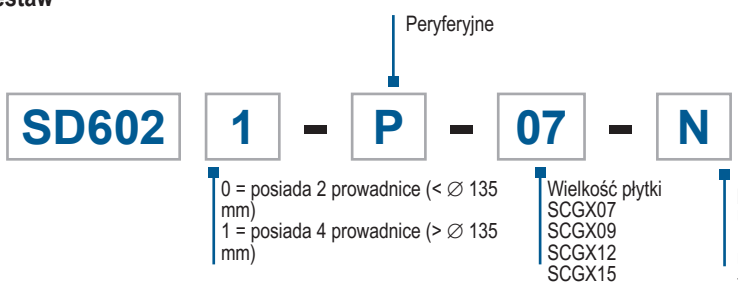

-N



-U

Całowe



Prowadnica



Zestaw modułowej głowicy wierzącej

SD602-59/60-40RG

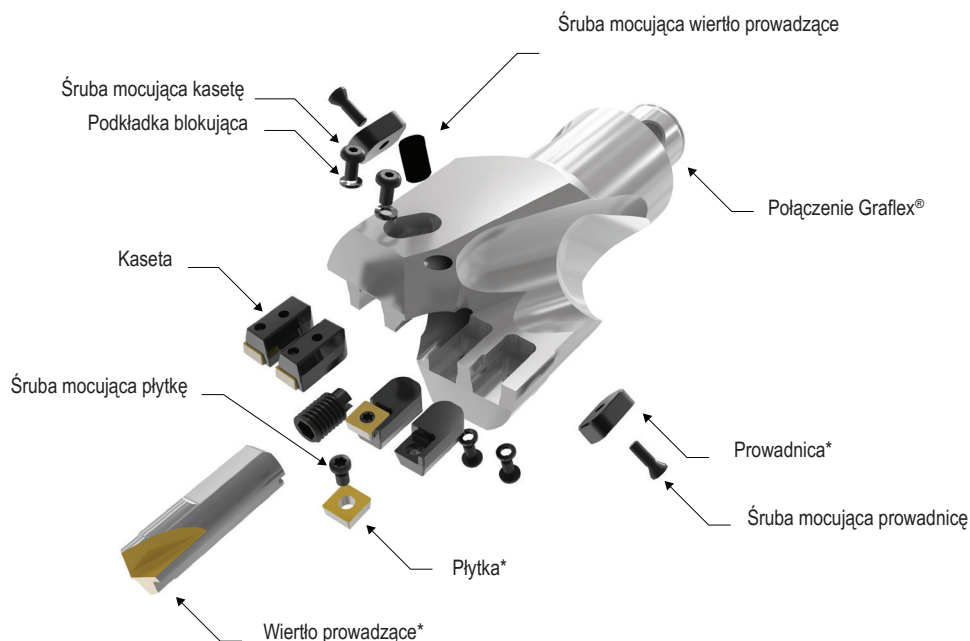

Przykład: Średnica 59; SD602-59-40RG
Użyć zestawu: SD6020-P07*

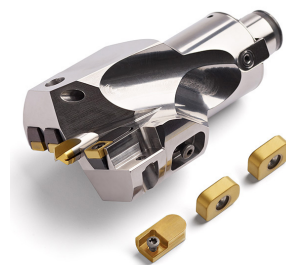

Przykład: Średnica 60; SD602-60-40RG
Użyć zestawu: SD6020-P07-N*

Wskazówki dotyczące mocowania

- Dokręć śrubę mocującą kasetę
- Zamocuj płytki
- Zamocuj wiertło prowadzące opierając o dno otworu, w przypadku konieczności wysunięcia wiertła użyć śruby regulacyjnej
- Zamocować przedłużki

Mocowanie wkładek oraz prowadnic

- Zamocuj kasetę
- Upewnij się iż kasety ściśle przylegają do gniazda korpusu
- Dokręć śrubę mocującą kasetę:
SD600-x-07: 3 Nm
SD600-x-09: 3 Nm
SD600-x-12: 8 Nm
SD600-x-15: 8 Nm
- Zamocuj prowadnicę
- Dokręć śrubę mocującą prowadnicę

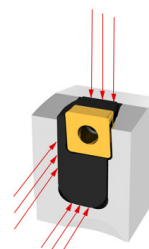

* Nie zawarte w dostawie. Zestaw zewnętrzny, wiertło prowadzące i płytki należy zamawiać osobno.

SD602

Modułowa głowica wierząca – Metryczne/Calowe

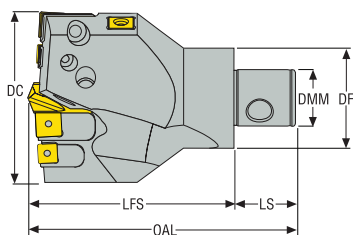

- Chłodzenie wewnętrzne
- Informacja na temat płytek patrz str. 292-298
- Parametry skrawania, patrz strona (strony) 311-312
- Wiertło prowadzące z regulowaną długością

Zakres											
Numer produktu	Oznaczenie	Wielk. Graflex	DCN	DCX	OAL	LFS	LS	DF	DMM	Waga	Płytki
			mm	mm	mm	mm	mm	mm	mm	kg	
			Cal.	Cal.	Cal.	Cal.	Cal.	Cal.	Cal.	lbs	
02846688	SD602-59/60-40RG	G4	59,0 2.323	60,0 2.362	129,0 5.079	105,0 4.134	24,0 0.945	40,0 1.575	22,0 0.866	0,9 1.980	SCGX07
02846689	SD602-69/70-40RG	G4	69,0 2.717	70,0 2.756	129,0 5.079	105,0 4.134	24,0 0.945	40,0 1.575	22,0 0.866	1,1 2.430	SCGX09
02846690	SD602-79/80-50RG	G5	79,0 3.110	80,0 3.150	160,0 6.299	130,0 5.118	30,0 1.181	50,0 1.969	28,0 1.102	1,8 3.970	SCGX09
02846691	SD602-89/90-50RG	G5	89,0 3.504	90,0 3.543	160,0 6.299	130,0 5.118	30,0 1.181	50,0 1.969	28,0 1.102	2,0 4.410	SCGX09/12
02846692	SD602-99/100-63RG	G6	99,0 3.898	100,0 3.937	185,0 7.283	145,0 5.709	40,0 1.575	63,0 2.480	36,0 1.417	3,1 6.830	SCGX12
02846693	SD602-119/120-63RG	G6	119,0 4.685	120,0 4.724	185,0 7.283	145,0 5.709	40,0 1.575	63,0 2.480	36,0 1.417	3,5 7.720	SCGX15
02846694	SD602-139/140-90RG	G7	139,0 5.472	140,0 5.512	210,0 8.268	160,0 6.299	50,0 1.969	90,0 3.543	46,0 1.811	6,1 13.450	SCGX12
02846695	SD602-159/160-90RG	G7	159,0 6.260	160,0 6.299	210,0 8.268	160,0 6.299	50,0 1.969	90,0 3.543	46,0 1.811	6,6 14.550	SCGX12/15
02846698	SD602-2500-40RG	G4	62,5 2.461	63,5 2.500	129,0 5.079	105,0 4.134	24,0 0.945	40,0 1.575	22,0 0.866	1,0 2.200	SCGX07
02846699	SD602-2750-40RG	G4	68,85 2.711	69,85 2.750	129,0 5.079	105,0 4.134	24,0 0.945	40,0 1.575	22,0 0.866	1,1 2.430	SCGX07/09
02846700	SD602-3000-40RG	G4	75,2 2.961	76,2 3.000	129,0 5.079	105,0 4.134	24,0 0.945	40,0 1.575	22,0 0.866	1,1 2.430	SCGX09
02846701	SD602-3250-50RG	G5	81,55 3.211	82,55 3.250	160,0 6.299	130,0 5.118	30,0 1.181	50,0 1.969	28,0 1.102	1,8 3.970	SCGX09/12
02846702	SD602-3500-50RG	G5	87,9 3.461	88,9 3.500	160,0 6.299	130,0 5.118	30,0 1.181	50,0 1.969	28,0 1.102	1,9 4.190	SCGX09/12
02846703	SD602-4000-63RG	G6	100,6 3.961	101,6 4.000	185,0 7.283	145,0 5.709	40,0 1.575	63,0 2.480	36,0 1.417	3,2 7.050	SCGX12

Części zamienne, zawarte w dostawie

Kaseta	Kaseta	Śruba mocująca kasetę	Podkładka	Śruba mocująca płytkę	Klucz do płytek	Prowadnica*	Prowadnica*	Śruba prowadnicy
SD600-C-07	SD600-P-07-N	K6S4x8	LW0408	C03007-T09P	T09P-2, T15P-2D	PAD-L20R25	PAD-L20R25-N	C04014-T15P
SD600-C-09	SD600-P-09-N	K6S4x8	LW0408	C03508-T15P	T15P-2D	PAD-L20R25	PAD-L20R25-N	C04014-T15P
SD600-C-12	SD600-P-12-N	K6S6x10	LW0611	C05012-T15P	T15P-2D	PAD-L20R25	PAD-L20R25-N	C04014-T15P
SD600-C-15	SD600-P-15-N	K6S6x12	LW0611	C05012-T15P	T15P-2D	PAD-L20R25	PAD-L20R25-N	C04014-T15P

*Nie zawarte w dostawie

SD602

Modułowa głowica wiercąca

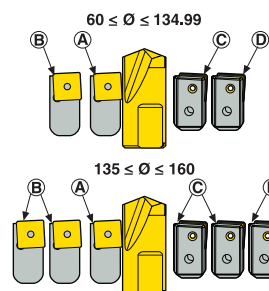

Części zamienne, zawarte w dostawie

Oznaczenie	Dla śred. wiertła (mm)	Dla śred. wiertła (cale)	Śruba pilota	Śruba regulacyjna	Kaseta (A)	Kaseta (B)	Kaseta (C)	Zestaw zewn.* (D)	Wierło prowadzące* x=0 Węgiel spiekany x=1 HSS
SD602-59/60-40RG	59	2.323	P6SS 8X8	19TLR0816	SD600-C-07	SD600-C-07	SD600-P-07	SD6020-P-07-U	SD601x-10-R
SD602-59/60-40RG	60	2.362	P6SS 8X8	19TLR0816	SD600-C-07	SD600-C-07	SD600-P-07	SD6020-P-07-N	SD601x-10-R
SD602-2500-40RG	62,5	2.461	P6SS 8X8	19TLR0816	SD600-C-07	SD600-C-07	SD600-P-07	SD6020-P-07-U	SD601x-10-R
SD602-2500-40RG	63,5	2.500	P6SS 8X8	19TLR0816	SD600-C-07	SD600-C-07	SD600-P-07	SD6020-P-07-N	SD601x-10-R
SD602-2750-40RG	68,85	2.711	P6SS 8X8	19TLR0816	SD600-C-09	SD600-C-07	SD600-P-07	SD6020-P-07-U	SD601x-10-R
SD602-2750-40RG	69,85	2.750	P6SS 8X8	19TLR0816	SD600-C-09	SD600-C-07	SD600-P-07	SD6020-P-07-N	SD601x-10-R
SD602-69/70-40RG	69	2.717	P6SS 8X8	19TLR0816	SD600-C-09	SD600-C-09	SD600-P-09	SD6020-P-09-U	SD601x-10-R
SD602-69/70-40RG	70	2.756	P6SS 8X8	19TLR0816	SD600-C-09	SD600-C-09	SD600-P-09	SD6020-P-09-N	SD601x-10-R
SD602-3000-40RG	75,2	2.961	P6SS 10X10	19TLR1016	SD600-C-09	SD600-C-09	SD600-P-09	SD6020-P-09-U	SD601x-15-R
SD602-3000-40RG	76,2	3.000	P6SS 10X10	19TLR1016	SD600-C-09	SD600-C-09	SD600-P-09	SD6020-P-09-N	SD601x-15-R
SD602-79/80-50RG	79	3.110	P6SS 10X10	19TLR1016	SD600-C-09	SD600-C-09	SD600-P-09	SD6020-P-09-U	SD601x-15-R
SD602-79/80-50RG	80	3.150	P6SS 10X10	19TLR1016	SD600-C-09	SD600-C-09	SD600-P-09	SD6020-P-09-N	SD601x-15-R
SD602-3250-50RG	81,55	3.211	P6SS 10X10	19TLR1016	SD600-C-12	SD600-C-09	SD600-P-09	SD6020-P-09-U	SD601x-15-R
SD602-3250-50RG	82,55	3.250	P6SS 10X10	19TLR1016	SD600-C-12	SD600-C-09	SD600-P-09	SD6020-P-09-N	SD601x-15-R
SD602-3500-50RG	87,9	3.461	P6SS 10X10	19TLR1016	SD600-C-12	SD600-C-09	SD600-P-09	SD6020-P-12-U	SD601x-15-R
SD602-3500-50RG	88,9	3.500	P6SS 10X10	19TLR1016	SD600-C-12	SD600-C-09	SD600-P-09	SD6020-P-12-N	SD601x-15-R
SD602-89/90-50RG	89	3.504	P6SS 10X10	19TLR1016	SD600-C-12	SD600-C-09	SD600-P-09	SD6020-P-12-U	SD601x-15-R
SD602-89/90-50RG	90	3.543	P6SS 10X10	19TLR1016	SD600-C-12	SD600-C-09	SD600-P-09	SD6020-P-12-N	SD601x-15-R
SD602-99/100-63RG	99	3.898	P6SS 10X10	19TLR1016	SD600-C-12	SD600-C-12	SD600-P-12	SD6020-P-12-U	SD601x-15-R
SD602-99/100-63RG	100	3.937	P6SS 10X10	19TLR1016	SD600-C-12	SD600-C-12	SD600-P-12	SD6020-P-12-N	SD601x-15-R
SD602-4000-63RG	100,6	3.961	P6SS 10X10	19TLR1016	SD600-C-12	SD600-C-12	SD600-P-12	SD6020-P-12-U	SD601x-15-R
SD602-4000-63RG	101,6	4.000	P6SS 10X10	19TLR1016	SD600-C-12	SD600-C-12	SD600-P-12	SD6020-P-12-N	SD601x-15-R
SD602-119/120-63RG	119	4.685	P6SS 10X10	19TLR1016	SD600-C-15	SD600-C-15	SD600-P-15	SD6020-P-15-U	SD601x-15-R
SD602-119/120-63RG	120	4.724	P6SS 10X10	19TLR1016	SD600-C-15	SD600-C-15	SD600-P-15	SD6020-P-15-N	SD601x-15-R
SD602-139/140-90RG	139	5.472	P6SS 12X12	19TLR1216	SD600-C-12	SD600-C-12	SD600-P-12	SD6021-P-12-U	SD601x-25-R
SD602-139/140-90RG	140	5.512	P6SS 12X12	19TLR1216	SD600-C-12	SD600-C-12	SD600-P-12	SD6021-P-12-N	SD601x-25-R
SD602-159/160-90RG	159	6.260	P6SS 12X12	19TLR1216	SD600-C-15	SD600-C-12	SD600-P-12	SD6021-P-15-U	SD601x-25-R
SD602-159/160-90RG	160	6.299	P6SS 12X12	19TLR1216	SD600-C-15	SD600-C-12	SD600-P-12	SD6021-P-15-N	SD601x-25-R

*Nie zawarte w dostawie. Zestaw peryferyjny, U- podwymiarowy U, N-nominalny.
Wielkości płytek patrz str. 292-298

Instrukcja ostrzenia dla SD602

Warunki techniczne:

Proponowany kształt ściernicy diamentowej:

Kąt przyłożenia na stożku: Kształt ściernicy 12A2 wielkość ziarna D54 (rys. 1).

Rowek wiórowy: Kształt ściernicy 1A1 lub 1V1 wielkość ziarna D64-D46 (rys. 2-3).

Faza na narożu: Kształt ściernicy 1A1 lub 12A2 (rys. 1).

Zabezp. krawędzi: szlifowanie płaszcz. K lub szczotkowanie (rys. 2).

Ważne:

- Krawędzie skrawające powinny być równe, a łysinka tej samej wielkości.
- Łysinka powinna występować na całej długości krawędzi skrawających.

1. Kąt wierzchołkowy

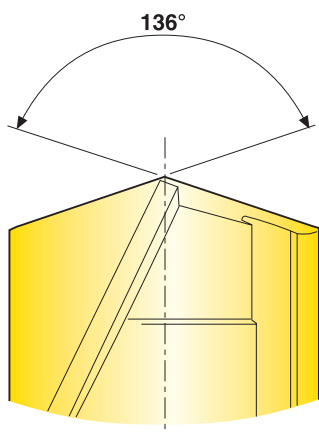

Zabezpieczenie krawędzi 0-0,1 mm (0-0.004") x 20°. Kąt zatoczenia 10°.

2. Faza na narożu

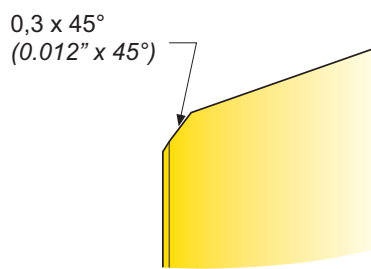

3.

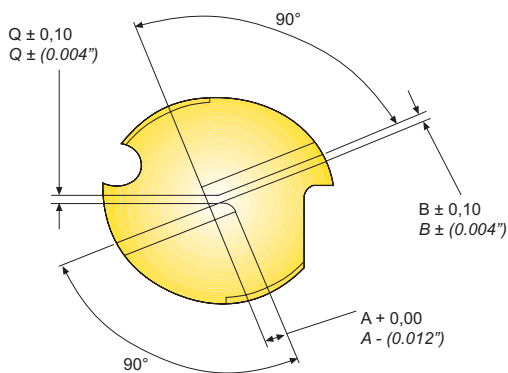

4.

Wymiary w mm (cale)				
Średnica	A	B	C	Minimalna długość
10 mm	1,5 (0.059)	0,5 (0.020)	0,57 (0.022)	38 (1.496)
15 mm	1,5 (0.059)	0,6 (0.024)	0,68 (0.027)	45 (1.772)
25 mm	1,5 (0.059)	1,4 (0.055)	1,6 (0.063)	57 (2.244)

Zestaw modułowej głowicy wierzącej

Zalety: Regulowane wiertło prowadzące

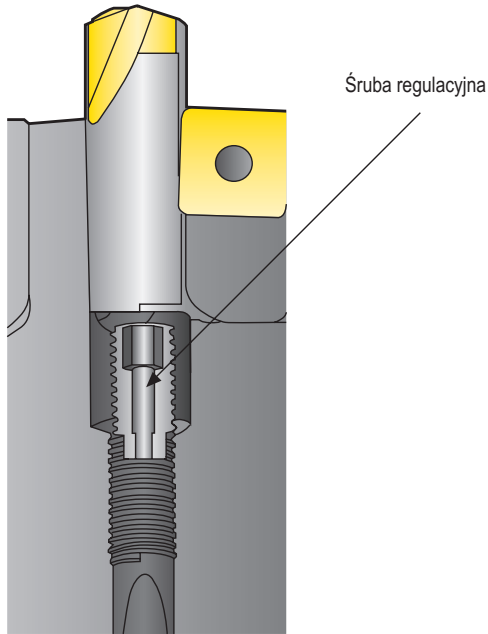

Wiertła	Regulowany dystans ADJRG	
	mm	cale
SD602-59/60-40RG	3,0	0.118
SD602-69/70-40RG	3,0	0.118
SD602-79/80-50RG	5,0	0.197
SD602-89/90-50RG	5,0	0.197
SD602-99/100-63RG	5,0	0.197
SD602-119/120-63RG	5,0	0.197
SD602-139/140-90RG	5,0	0.197
SD602-159/160-90RG	5,0	0.197
SD602-2500-40RG	3,0	0.118
SD602-2750-40RG	3,0	0.118
SD602-3000-40RG	5,0	0.197
SD602-3250-50RG	5,0	0.197
SD602-3500-50RG	5,0	0.197
SD602-4000-63RG	5,0	0.197

Zalety: Regulowany dystans

Korzyści: Ta sama długość ustawienia po regeneracji wiertła prowadzącego.
Możliwość regulacji wysięgu wiertła prowadzącego.
Przy głębokości wiercenia > 5 x D zaleca się wystawienie 5 mm (0.197")
Zalecenia: W przypadku ponownego wejścia w otwór wiertło prowadzące powinno zostać wysunięte ok. 3 mm (0.118") od swojego oryginalnego położenia, w celu poprawy centrowania.

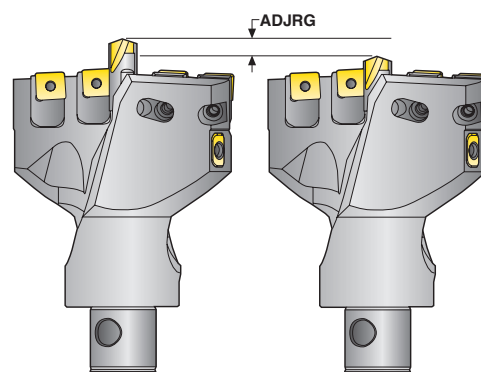

Zestaw modułowej głowicy wierzącej

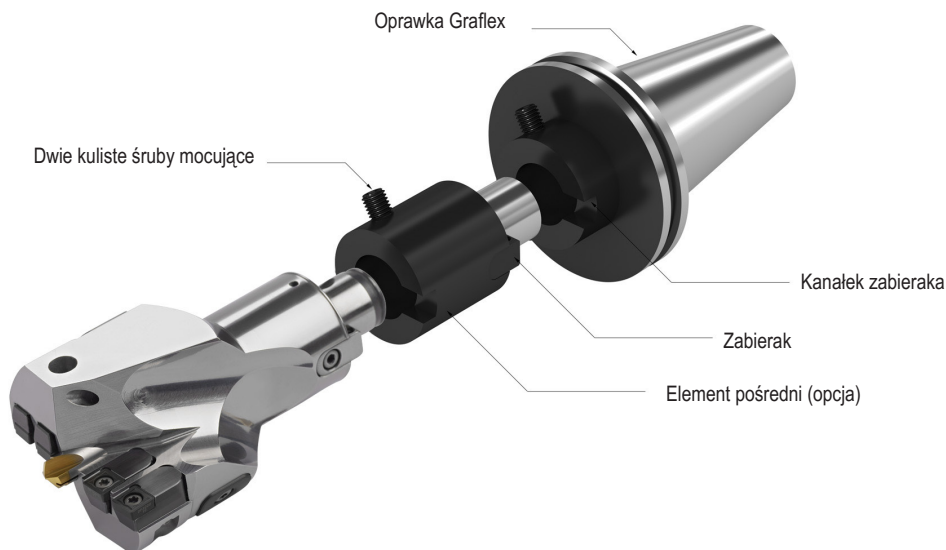

Wskazówki dotyczące mocowania

1. Oczyszczyć montowane elementy oraz nałożyć cienką warstwę smaru.
2. Ułożenie elementów jest poprawne gdy lewa strona zabieraka styka się z lewą stroną rowka pod zabierak.
3. Lekko dokręcić śrubę A (aby znaleźć najniższy punkt dla śruby A, należy przesunąć głowice wiertarskie do przodu i do tyłu).
4. Lekko dokręcić śrubę B
5. „Dokręcić” śrubę zabezpieczającą C
6. „Dokręcić” śrubę A
7. „Dokręcić” śrubę B
8. Ponownie sprawdzić dokręcenie śruby zabezpieczającej.

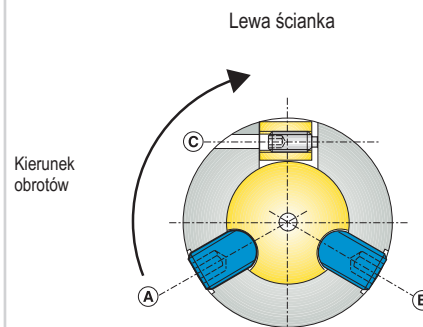
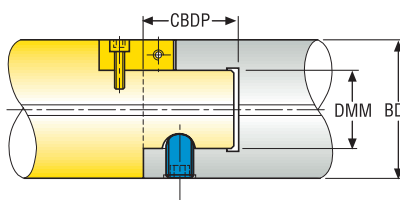

Zalecane momenty mocowania dla połączeń Graflex

Wielkość Graflex	DMM mm (cale)	BD mm (cale)	CBDP mm (cale)	Śruby kuliste (A) i (B)	Śruba blokująca (C)
4	22 (0.866)	40 (1.575)	24 (0.945)	20 Nm (14.7 st./funt)	0.7 Nm (0.5 stopy/funt)
5	28 (1.102)	50 (1.969)	30 (1.181)	25 Nm (18.4 stopy/funt)	2 Nm (1.5 stopy/funt)
6	36 (1.417)	63 (2.480)	40 (1.575)	35 Nm (25.8 stopy/funt)	4 Nm (2.9 stopy/funt)
7	46 (1.811)	90 (3.543)	50 (1.969)	60 Nm (44.2 stopy/funt)	8 Nm (5.9 stopy/funt)

Gatunek płytki

Właściwości:

- 4 krawędzie skrawające na płytkę
- Mocne kwadratowe płytki

Korzyści:

- Ekonomiczne
- Niezawodne
- Wydajne
- Niski koszt na otwór

Zewnętrzna

<p>DP2000</p>		<p>Technologia pokrycia DURATOMIC® Optymalny gatunek do stali oraz żeliwa Do pracy z bardzo dużymi prędkościami skrawania Unikatowa kombinacja ciągliwości krawędzi oraz odpornego na zużycie pokrycia Ti(C,N) + Al₂O₃ DURATOMIC®</p>
<p>DP3000</p>		<p>Technologia pokrycia DURATOMIC® Gatunek uniwersalny Wysoka odporność na ścieranie oraz ciągliwość krawędzi Ciągliwy gatunek dla zapewnienia maksymalnego bezpieczeństwa Ti(C,N) + Al₂O₃ DURATOMIC® Gradientowe podłoże</p>
<p>DS2050</p>		<p>Gatunek optymalny do tytanu, superstopów i trudnoobrabialnych stali nierdzewnych Pokrycie PVD TiAlN + NbN</p>
<p>T250D</p>		<p>Bardziej odpowiedni do twardych materiałów Pierwszy wybór do aluminium Ciągliwy mikroziarnisty z pokryciem TiAlN zapewniającym - Ekstremalnie wysoką twardość - Wysoka odporność na zużycie chemiczne oraz utlenianie Pokrycie PVD (Ti, Al)N + TiN</p>

Centralna

<p>T400D</p>		<p>Pierwszy wybór Ciągliwy gatunek płytki centralnej zapewniający maksymalne bezpieczeństwo PVD pokrywany (Ti, Al)N + TiN</p>
<p>DP3000</p>		<p>Technologia pokrycia DURATOMIC® Gatunek uniwersalny Wysoka odporność na ścieranie oraz ciągliwość krawędzi Ciągliwy gatunek dla zapewnienia maksymalnego bezpieczeństwa Ti(C,N) + Al₂O₃ DURATOMIC® Gradientowe podłoże</p>
<p>DS4050</p>		<p>Gatunek optymalny do tytanu, superstopów i trudnoobrabialnych stali nierdzewnych Pokrycie PVD TiAlN + NbN</p>

Geometrie



1. Kształt płytki			2. Kąt przyłożenia płytki			4. Typ																																																																			
						X = Specjalne																																																																			
3. Tolerancje			5. Długość krawędzi skrawającej																																																																						
<table border="1"> <thead> <tr> <th rowspan="2">Tol. klasa</th> <th colspan="3">Tolerancja +/- mm (cale)</th> <th colspan="10">Śred. IC - wymiar w mm (cale)</th> </tr> <tr> <th>m</th> <th>S</th> <th>IC</th> <th>5,556 (0.2187)</th> <th>6,35 (0.2500)</th> <th>7,937 (0.3125)</th> <th>7,94 (0.3126)</th> <th>9,525 (0.3750)</th> <th>11,509 (0.4531)</th> <th>12,7 (0.5000)</th> <th>15,875 (0.6250)</th> <th>19,05 (0.7500)</th> </tr> </thead> <tbody> <tr> <td>G</td> <td>0,025 (0.001)</td> <td>0,13 (0.005)</td> <td>0,025 (0.001)</td> <td>•</td> <td>•</td> <td>•</td> <td>•</td> <td>•</td> <td>•</td> <td>•</td> <td>•</td> <td>•</td> </tr> <tr> <td>M</td> <td>0,013 (0.005)</td> <td>0,13 (0.005)</td> <td>0,05 (0.002)</td> <td>•</td> <td>•</td> <td>•</td> <td>•</td> <td>•</td> <td>•</td> <td>•</td> <td>•</td> <td>•</td> </tr> <tr> <td>M</td> <td>0,013 (0.005)</td> <td>0,13 (0.005)</td> <td>0,08 (0.003)</td> <td></td> <td></td> <td></td> <td></td> <td></td> <td></td> <td>•</td> <td></td> <td></td> </tr> </tbody> </table>			Tol. klasa	Tolerancja +/- mm (cale)			Śred. IC - wymiar w mm (cale)										m	S	IC	5,556 (0.2187)	6,35 (0.2500)	7,937 (0.3125)	7,94 (0.3126)	9,525 (0.3750)	11,509 (0.4531)	12,7 (0.5000)	15,875 (0.6250)	19,05 (0.7500)	G	0,025 (0.001)	0,13 (0.005)	0,025 (0.001)	•	•	•	•	•	•	•	•	•	M	0,013 (0.005)	0,13 (0.005)	0,05 (0.002)	•	•	•	•	•	•	•	•	•	M	0,013 (0.005)	0,13 (0.005)	0,08 (0.003)							•								
Tol. klasa	Tolerancja +/- mm (cale)			Śred. IC - wymiar w mm (cale)																																																																					
	m	S	IC	5,556 (0.2187)	6,35 (0.2500)	7,937 (0.3125)	7,94 (0.3126)	9,525 (0.3750)	11,509 (0.4531)	12,7 (0.5000)	15,875 (0.6250)	19,05 (0.7500)																																																													
G	0,025 (0.001)	0,13 (0.005)	0,025 (0.001)	•	•	•	•	•	•	•	•	•																																																													
M	0,013 (0.005)	0,13 (0.005)	0,05 (0.002)	•	•	•	•	•	•	•	•	•																																																													
M	0,013 (0.005)	0,13 (0.005)	0,08 (0.003)							•																																																															
6. Grubość			7. Płytki z fazą lub promieniem na narożu			10. Oznaczenie wewnętrzne																																																																			
<p>02 = 2,38 mm (0.094") 03 = 3,18 mm (0.125") T3 = 3,97 mm (0.156")</p> <p>04 = 4,76 mm (0.187") 05 = 5,56 mm (0.219")</p>			<p>04 = 0,4 mm (0.016") 08 = 0,8 mm (0.031") 12 = 1,2 mm (0.047") itp.</p>			<p>np. oznaczenie łamacza</p> <p>P1 = xx P2 = xx 85 = xx 86 = xx</p>																																																																			

Wstęp

Wiercenie

Rozwiercanie

Wytłaczanie

Załącznik

Płytki skrawające – Płytki peryferyjna, typ P1*

do SD522, SD523, SD524, SD525, SD542, SD602

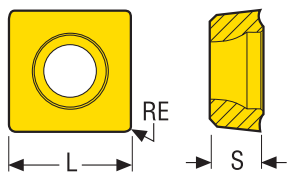

Tolerancje:
L = $\pm 0,025$ (0.001")
S = $\pm 0,13$ (0.005")
RE = $\pm 0,1$ (0.004")

SCGX-P1

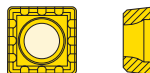

Oznaczenie	Płytki	L			S			RE		
		mm	Cal.	mm	mm	mm	T250D	DP2000	DP3000	
SCGX060204-P1	SCGX-P1	6,35	0,25	2,381	0,094	0,4	0,016	00059712	02590849	02807362
SCGX070308-P1	SCGX-P1	7,938	0,313	3,18	0,125	0,8	0,031	00059713	02590850	02807363
SCGX09T308-P1	SCGX-P1	9,525	0,375	3,969	0,156	0,8	0,031	00059714	02590851	02807364
SCGX11T308-P1	SCGX-P1	11,509	0,453	3,97	0,156	0,8	0,031	03136962	03136963	03136964
SCGX120408-P1	SCGX-P1	12,7	0,5	4,762	0,187	0,8	0,031	00059715	02590852	02807365
SCGX150512-P1	SCGX-P1	15,875	0,625	5,556	0,219	1,2	0,047	00059716	02590853	02807366

* Łamacz do małych posuwów i do dobrego wykończenia powierzchni we wszystkich materiałach

Płytki skrawające – Płytko peryferyjna, typ P2**

do SD522, SD523, SD524, SD525, SD542, SD602

Tolerancje:
L = $\pm 0,025$ (0.001")
S = $\pm 0,13$ (0.005")
RE = $\pm 0,1$ (0.004")

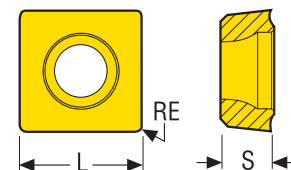

SCGX-P2



Oznaczenie	Płytki	L	S	RE	Gatunki		
		mm Cal.	mm Cal.	mm Cal.	T250D	DP2000	DP3000
SCGX050204-P2	SCGX-P2	5,556 0,219	2,38 0,094	0,4 0,016	00059711	02590854	02807356
SCGX060204-P2	SCGX-P2	6,35 0,25	2,38 0,094	0,4 0,016	02526803	02590855	02807357
SCGX070308-P2	SCGX-P2	7,937 0,312	3,18 0,125	0,8 0,031	02526787	02590856	02807358
SCGX09T308-P2	SCGX-P2	9,525 0,375	3,97 0,156	0,8 0,031	02794476	02590857	02807359
SCGX11T308-P2	SCGX-P2	11,509 0,453	3,97 0,156	0,8 0,031	03097760	03097761	03097762
SCGX120408-P2	SCGX-P2	12,7 0,5	4,76 0,187	0,8 0,031	02794477	02590858	02807360
SCGX150512-P2	SCGX-P2	15,875 0,625	5,56 0,219	1,2 0,047	02794478	02590859	02807361

** Łamacz do małych posuwu w stali, stali nierdzewnej i żeliwa

Płytki skrawające – Płytki peryferyjna, do typu MP

do SD522, SD523, SD524, SD525, SD542, SD602

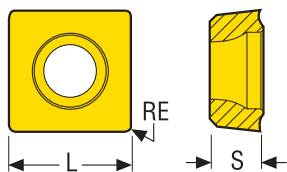

Tolerancje:
L = $\pm 0,025$ (0.001")
S = $\pm 0,13$ (0.005")
RE = $\pm 0,1$ (0.004")

SCGX-MP



Oznaczenie	Płytki	L	S	RE	Gatunki
		mm Cal.	mm Cal.	mm Cal.	DS2050
SCGX050204-MP	SCGX-MP	5,56 0,219	2,38 0,094	0,4 0,016	03134312
SCGX060204-MP	SCGX-MP	6,35 0,25	6,35 0,25	0,4 0,016	03134313
SCGX070308-MP	SCGX-MP	7,94 0,313	3,18 0,125	0,8 0,031	03134314
SCGX09T308-MP	SCGX-MP	9,525 0,375	3,97 0,156	0,8 0,031	03134315
SCGX11T308-MP	SCGX-MP	11,509 0,453	3,97 0,156	0,8 0,031	03134316
SCGX120408-MP	SCGX-MP	12,7 0,5	4,76 0,187	0,8 0,031	03134317
SCGX150512-MP	SCGX-MP	15,875 0,625	5,56 0,219	1,2 0,047	03134318

Płytki skrawające – Płytki centralna, typ C1

do SD522, SD523, SD524, SD525, SD542

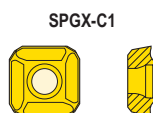
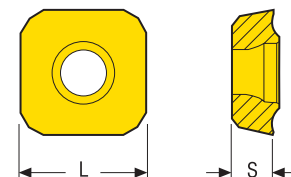
Tolerancje:
L = $\pm 0,025$ (0.001")
S = $\pm 0,13$ (0.005")

Oznaczenie	Płytki	L		S		Gatunki	
		mm	Cal.	mm	Cal.	T400D	DP3000
SPGX0502-C1	SPGX-C1	5,556	0,219	2,38	0,094	74077370	02807367
SPGX0602-C1	SPGX-C1	6,35	0,25	2,38	0,094	74077371	02807368
SPGX0703-C1	SPGX-C1	7,937	0,312	3,18	0,125	74077372	02807369
SPGX0903-C1	SPGX-C1	9,525	0,375	3,18	0,125	74077373	02807370
SPGX11T3-C1	SPGX-C1	11,509	0,453	3,97	0,156	74077374	02807371
SPGX12T3-C1	SPGX-C1	12,7	0,5	3,97	0,156	74077375	02807372
SPGX1504-C1	SPGX-C1	15,875	0,625	4,76	0,187	74077376	02807373
SPGX1904-C1	SPGX-C1	19,05	0,75	4,76	0,187	74077377	02807374

Płytki skrawające – Płytki centralna, typ MC

do SD522, SD523, SD524, SD525, SD542

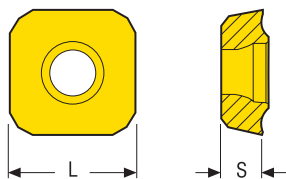

Tolerancje:
L = $\pm 0,025$ (0.001")
S = $\pm 0,13$ (0.005")

SPGX-MC

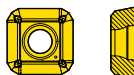

Oznaczenie	Płytki	L	S	Gatunki
		mm <i>Cal.</i>	mm <i>Cal.</i>	DS4050
SPGX0502-MC	SPGX-MC	5,56 0,219	2,38 0,094	03134319
SPGX0602-MC	SPGX-MC	6,35 0,25	2,38 0,094	03134320
SPGX0703-MC	SPGX-MC	7,94 0,313	3,18 0,125	03134321
SPGX0903-MC	SPGX-MC	9,525 0,375	3,18 0,125	03134322
SPGX11T3-MC	SPGX-MC	11,509 0,453	3,97 0,156	03134323
SPGX12T3-MC	SPGX-MC	12,7 0,5	3,97 0,156	03134324
SPGX1504-MC	SPGX-MC	15,875 0,625	4,76 0,187	03134325
SPGX1904-MC	SPGX-MC	19,05 0,75	4,76 0,187	03134326

Płytki skrawające – Płytki peryferyjna, typ 85*

do SD572

Tolerancje:
S = $\pm 0,13$ (0.005")
RE = $\pm 0,1$ (0.004")

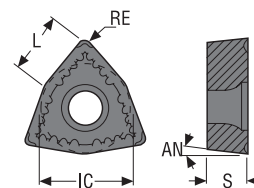

WCMX-85



Oznaczenie	Płytki	IC	L	S	RE	Gatunki
		mm Cal.	mm Cal.	mm Cal.	mm Cal.	DP3000
WCMX040208-85	WCMX-85	6,35 0,25	3,99 0,157	2,38 0,094	0,8 0,031	02807375
WCMX050308-85	WCMX-85	7,94 0,313	5,07 0,2	3,18 0,125	0,8 0,031	02807376
WCMX06T308-85	WCMX-85	9,525 0,375	6,14 0,242	3,97 0,156	0,8 0,031	02807377
WCMX080412-85	WCMX-85	12,7 0,5	8,14 0,32	4,76 0,187	1,2 0,047	02807378

** Łamacz do małych posuwu w stali, stali nierdzewnej i żeliwa

Płytki centralna, płytki zewnętrzna łamacz 86**

do SD572

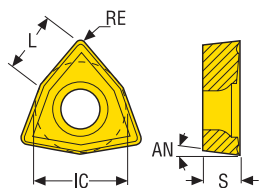

Tolerancje:
S = $\pm 0,13$ (0.005")
RE = $\pm 0,1$ (0.004")

WCMX-86



Oznaczenie	Płytki	IC	L	S	RE	Gatunki		
		mm Cal.	mm Cal.	mm Cal.	mm Cal.	T400D	DP2000	DP3000
WCMX030208-86	WCMX-86	5,556 0,219	3,46 0,136	2,38 0,094	0,8 0,031	02506629	02899808	02807379
WCMX040208-86	WCMX-86	6,35 0,25	3,99 0,157	2,38 0,094	0,8 0,031	02506638	02899809	02807380
WCMX050308-86	WCMX-86	7,94 0,313	5,07 0,2	3,18 0,125	0,8 0,031	02506640	02899810	02807381
WCMX06T308-86	WCMX-86	9,525 0,375	6,14 0,242	3,97 0,156	0,8 0,031	02506645	02899811	02807382
WCMX080412-86	WCMX-86	12,7 0,5	8,14 0,32	4,76 0,187	1,2 0,047	02506646	02899812	02807383

** Łamacz do małych posuwów w stali, stali nierdzewnej i żeliwa

SD522 Ø 15-60 mm / 0.590-2.375 cale

SMG		f							v _c
		Ø 15,00-19,49 Ø 0.590-0.767	Ø 19,50-22,49 Ø 0.768-0.885	Ø 22,50-28,49 Ø 0.886-1.121	Ø 28,50-34,49 Ø 1.122-1.357	Ø 34,50-40,49 Ø 1.358-1.593	Ø 40,49-44,49 Ø 1.594-1.751	Ø 44,50-59,99 Ø 1.752-2.375	
P1	P1 DP2000	0,060	0,070	0,085	0,095	0,11	0,12	0,13	460
	P1 DP2000	0,0024	0,0028	0,0034	0,0038	0,0044	0,0048	0,0050	1500
P2	P1 DP2000	0,060	0,070	0,085	0,10	0,11	0,12	0,13	450
	P1 DP2000	0,0024	0,0028	0,0034	0,0040	0,0044	0,0048	0,0050	1475
P3	P2 DP3000	0,12	0,14	0,17	0,19	0,22	0,22	0,26	345
	P2 DP3000	0,0048	0,0055	0,0065	0,0075	0,0085	0,0085	0,010	1125
P4	P2 DP3000	0,12	0,13	0,16	0,19	0,22	0,22	0,25	220
	P2 DP3000	0,0048	0,0050	0,0065	0,0075	0,0085	0,0085	0,010	720
P5	P2 DP3000	0,11	0,13	0,16	0,18	0,20	0,22	0,25	210
	P2 DP3000	0,0044	0,0050	0,0065	0,0070	0,0080	0,0085	0,010	690
P6	P2 DP3000	0,11	0,13	0,16	0,18	0,20	0,22	0,25	235
	P2 DP3000	0,0044	0,0050	0,0065	0,0070	0,0080	0,0085	0,010	770
P7	P2 DP3000	0,11	0,13	0,16	0,18	0,20	0,22	0,25	225
	P2 DP3000	0,0044	0,0050	0,0065	0,0070	0,0080	0,0085	0,010	740
P8	P2 DP3000	0,12	0,14	0,17	0,19	0,22	0,22	0,26	210
	P2 DP3000	0,0048	0,0055	0,0065	0,0075	0,0085	0,0085	0,010	690
P11	P2 DP3000	0,11	0,13	0,16	0,18	0,20	0,22	0,25	215
	P2 DP3000	0,0044	0,0050	0,0065	0,0070	0,0080	0,0085	0,010	710
P12	P2 DP3000	0,075	0,090	0,11	0,12	0,14	0,15	0,17	130
	P2 DP3000	0,0030	0,0036	0,0044	0,0048	0,0055	0,0060	0,0065	425
M1	P2 DP3000	0,085	0,10	0,12	0,14	0,16	0,17	0,19	260
	P2 DP3000	0,0034	0,0040	0,0048	0,0055	0,0065	0,0065	0,0075	850
M2	P2 DP3000	0,080	0,090	0,11	0,13	0,14	0,15	0,17	210
	P2 DP3000	0,0032	0,0036	0,0044	0,0050	0,0055	0,0060	0,0065	690
M3	MP DS2050	0,065	0,075	0,090	0,10	0,12	0,13	0,14	160
	MP DS2050	0,0026	0,0030	0,0036	0,0040	0,0048	0,0050	0,0055	520
M4	MP DS2050	0,055	0,065	0,080	0,090	0,10	0,11	0,12	140
	MP DS2050	0,0022	0,0026	0,0032	0,0036	0,0040	0,0044	0,0048	460
M5	MP DS2050	0,055	0,065	0,080	0,090	0,10	0,11	0,12	115
	MP DS2050	0,0022	0,0026	0,0032	0,0036	0,0040	0,0044	0,0048	375
K1	P2 DP2000	0,12	0,14	0,17	0,20	0,22	0,24	0,26	250
	P2 DP2000	0,0048	0,0055	0,0065	0,0080	0,0085	0,0095	0,010	820
K2	P2 DP2000	0,11	0,13	0,16	0,18	0,20	0,22	0,24	215
	P2 DP2000	0,0044	0,0050	0,0065	0,0070	0,0080	0,0085	0,0095	710
K3	P2 DP2000	0,11	0,13	0,16	0,18	0,20	0,22	0,24	185
	P2 DP2000	0,0044	0,0050	0,0065	0,0070	0,0080	0,0085	0,0095	610
K4	P2 DP2000	0,11	0,13	0,16	0,18	0,20	0,22	0,24	175
	P2 DP2000	0,0044	0,0050	0,0065	0,0070	0,0080	0,0085	0,0095	570
K5	P2 DP2000	0,10	0,11	0,14	0,16	0,18	0,19	0,22	105
	P2 DP2000	0,0040	0,0044	0,0055	0,0065	0,0070	0,0075	0,0085	345
N1	P1 T250D	0,12	0,14	0,17	0,20	0,22	0,24	0,26	365
	P1 T250D	0,0048	0,0055	0,0065	0,0080	0,0085	0,0095	0,010	1200
N2	P1 T250D	0,12	0,14	0,17	0,20	0,22	0,24	0,26	235
	P1 T250D	0,0048	0,0055	0,0065	0,0080	0,0085	0,0095	0,010	770
N3	P1 T250D	0,12	0,14	0,17	0,20	0,22	0,24	0,26	155
	P1 T250D	0,0048	0,0055	0,0065	0,0080	0,0085	0,0095	0,010	510
N11	P1 T250D	0,12	0,14	0,17	0,20	0,22	0,24	0,26	310
	P1 T250D	0,0048	0,0055	0,0065	0,0080	0,0085	0,0095	0,010	1025
S1	MP DS2050	0,090	0,11	0,13	0,15	0,17	0,18	0,20	60
	MP DS2050	0,0036	0,0044	0,0050	0,0060	0,0065	0,0070	0,0080	195
S2	MP DS2050	0,090	0,11	0,13	0,15	0,17	0,18	0,20	48
	MP DS2050	0,0036	0,0044	0,0050	0,0060	0,0065	0,0070	0,0080	155
S3	MP DS2050	0,085	0,10	0,12	0,14	0,16	0,17	0,19	41
	MP DS2050	0,0034	0,0040	0,0048	0,0055	0,0065	0,0065	0,0075	135
S11	MP DS2050	0,11	0,12	0,15	0,17	0,19	0,20	0,24	85
	MP DS2050	0,0044	0,0048	0,0060	0,0065	0,0075	0,0080	0,0095	280
S12	MP DS2050	0,11	0,12	0,15	0,17	0,19	0,20	0,24	65
	MP DS2050	0,0044	0,0048	0,0060	0,0065	0,0075	0,0080	0,0095	215
S13	MP DS2050	0,090	0,11	0,13	0,15	0,17	0,18	0,20	50
	MP DS2050	0,0036	0,0044	0,0050	0,0060	0,0065	0,0070	0,0080	165
H3	P1 T250D	0,050	0,060	0,070	0,080	0,095	0,10	0,11	70
	P1 T250D	0,0020	0,0024	0,0028	0,0032	0,0038	0,0040	0,0044	230
H5	P1 T250D	0,075	0,090	0,11	0,12	0,14	0,15	0,17	130
	P1 T250D	0,0030	0,0036	0,0044	0,0048	0,0055	0,0060	0,0065	425
H7	P1 T250D	0,050	0,060	0,070	0,080	0,095	0,10	0,11	70
	P1 T250D	0,0020	0,0024	0,0028	0,0032	0,0038	0,0040	0,0044	230
H8	P1 T250D	0,060	0,070	0,085	0,095	0,11	0,11	0,13	130
	P1 T250D	0,0024	0,0028	0,0034	0,0038	0,0044	0,0044	0,0050	425
H11	P1 T250D	0,075	0,090	0,11	0,12	0,14	0,15	0,17	165
	P1 T250D	0,0030	0,0036	0,0044	0,0048	0,0055	0,0060	0,0065	540
H12	P1 T250D	0,060	0,070	0,085	0,095	0,11	0,11	0,13	150
	P1 T250D	0,0024	0,0028	0,0034	0,0038	0,0044	0,0044	0,0050	490
H21	P1 T250D	0,060	0,070	0,085	0,095	0,11	0,11	0,13	130
	P1 T250D	0,0024	0,0028	0,0034	0,0038	0,0044	0,0044	0,0050	425

SMG = Grupy materiałowe Seco f = mm/obr (cal/obr) v_c = m/min (stp/min) Wszystkie parametry są wartościami początkowymi

Wstęp

Wiercenie

Rozwiercanie

Wyłaczanie

Załącznik

SD522 Prędkość skrawania

SMG	v _c			
	DP2000	DP3000	T250D	DS2050
P1	460	415	315	415
	1500	1350	1025	1350
P2	450	405	305	405
	1475	1325	1000	1325
P3	385	345	265	345
	1275	1125	870	1125
P4	285	220	140	—
	940	720	460	—
P5	270	210	135	—
	890	690	445	—
P6	305	235	150	—
	1000	770	490	—
P7	285	225	140	—
	940	740	460	—
P8	270	210	135	—
	890	690	445	—
P11	280	215	140	—
	920	710	460	—
P12	165	130	80	—
	540	425	260	—
M1	—	260	160	—
	—	850	520	—
M2	—	210	130	—
	—	690	425	—
M3	—	160	100	160
	—	520	330	520
M4	—	120	75	140
	—	395	245	460
M5	—	100	60	115
	—	330	195	375
K1	250	235	—	—
	820	770	—	—
K2	215	205	—	—
	710	670	—	—
K3	185	175	—	—
	610	570	—	—
K4	175	165	—	—
	570	540	—	—
K5	105	100	—	—
	345	330	—	—
N1	—	420	365	365
	—	1375	1200	1200
N2	—	270	235	235
	—	890	770	770
N3	—	180	155	155
	—	590	510	510
N11	—	350	310	310
	—	1150	1025	1025
S1	—	—	40	60
	—	—	130	195
S2	—	—	30	48
	—	—	100	155
S3	—	—	30	41
	—	—	100	135
S11	—	—	80	85
	—	—	260	280
S12	—	—	60	65
	—	—	195	215
S13	—	—	46	50
	—	—	150	165
H3	—	70	70	—
	—	230	230	—
H5	—	130	130	—
	—	425	425	—
H7	—	70	70	—
	—	230	230	—
H8	—	130	130	—
	—	425	425	—
H11	—	165	165	—
	—	540	540	—
H12	—	75	150	—
	—	245	490	—
H21	—	130	130	—
	—	425	425	—

SMG = Grupy materiałowe Seco v_c = m/min (stp/min) Wszystkie parametry są wartościami początkowymi

SD523 Ø 15-60 mm / 0.590-2.375 cale

SMG		f							v _c
		Ø 15,00-19,49 Ø 0.590-0.767	Ø 19,50-22,49 Ø 0.768-0.885	Ø 22,50-28,49 Ø 0.886-1.121	Ø 28,50-34,49 Ø 1.122-1.357	Ø 34,50-40,49 Ø 1.358-1.593	Ø 40,49-44,49 Ø 1.594-1.751	Ø 44,50-59,99 Ø 1.752-2.375	
P1	P1 DP2000	0,060	0,070	0,085	0,095	0,11	0,12	0,13	415
	P1 DP2000	0,0024	0,0028	0,0034	0,0038	0,0044	0,0048	0,0050	1350
P2	P1 DP2000	0,060	0,070	0,085	0,10	0,11	0,12	0,13	405
	P1 DP2000	0,0024	0,0028	0,0034	0,0040	0,0044	0,0048	0,0050	1325
P3	P2 DP3000	0,12	0,14	0,17	0,19	0,22	0,22	0,26	310
	P2 DP3000	0,0048	0,0055	0,0065	0,0075	0,0085	0,0085	0,010	1025
P4	P2 DP3000	0,12	0,13	0,16	0,19	0,22	0,22	0,25	190
	P2 DP3000	0,0048	0,0050	0,0065	0,0075	0,0085	0,0085	0,010	620
P5	P2 DP3000	0,11	0,13	0,16	0,18	0,20	0,22	0,25	180
	P2 DP3000	0,0044	0,0050	0,0065	0,0070	0,0080	0,0085	0,010	590
P6	P2 DP3000	0,11	0,13	0,16	0,18	0,20	0,22	0,25	200
	P2 DP3000	0,0044	0,0050	0,0065	0,0070	0,0080	0,0085	0,010	660
P7	P2 DP3000	0,11	0,13	0,16	0,18	0,20	0,22	0,25	190
	P2 DP3000	0,0044	0,0050	0,0065	0,0070	0,0080	0,0085	0,010	620
P8	P2 DP3000	0,12	0,14	0,17	0,19	0,22	0,22	0,26	180
	P2 DP3000	0,0048	0,0055	0,0065	0,0075	0,0085	0,0085	0,010	590
P11	P2 DP3000	0,11	0,13	0,16	0,18	0,20	0,22	0,25	185
	P2 DP3000	0,0044	0,0050	0,0065	0,0070	0,0080	0,0085	0,010	610
P12	P2 DP3000	0,075	0,090	0,11	0,12	0,14	0,15	0,17	110
	P2 DP3000	0,0030	0,0036	0,0044	0,0048	0,0055	0,0060	0,0065	360
M1	P2 DP3000	0,085	0,10	0,12	0,14	0,16	0,17	0,19	245
	P2 DP3000	0,0034	0,0040	0,0048	0,0055	0,0065	0,0065	0,0075	800
M2	P2 DP3000	0,080	0,090	0,11	0,13	0,14	0,15	0,17	195
	P2 DP3000	0,0032	0,0036	0,0044	0,0050	0,0055	0,0060	0,0065	640
M3	MP DS2050	0,065	0,075	0,090	0,10	0,12	0,13	0,14	150
	MP DS2050	0,0026	0,0030	0,0036	0,0040	0,0048	0,0050	0,0055	490
M4	MP DS2050	0,055	0,065	0,080	0,090	0,10	0,11	0,12	120
	MP DS2050	0,0022	0,0026	0,0032	0,0036	0,0040	0,0044	0,0048	395
M5	MP DS2050	0,055	0,065	0,080	0,090	0,10	0,11	0,12	100
	MP DS2050	0,0022	0,0026	0,0032	0,0036	0,0040	0,0044	0,0048	330
K1	P2 DP2000	0,12	0,14	0,17	0,20	0,22	0,24	0,26	225
	P2 DP2000	0,0048	0,0055	0,0065	0,0080	0,0085	0,0095	0,010	740
K2	P2 DP2000	0,11	0,13	0,16	0,18	0,20	0,22	0,24	195
	P2 DP2000	0,0044	0,0050	0,0065	0,0070	0,0080	0,0085	0,0095	640
K3	P2 DP2000	0,11	0,13	0,16	0,18	0,20	0,22	0,24	165
	P2 DP2000	0,0044	0,0050	0,0065	0,0070	0,0080	0,0085	0,0095	540
K4	P2 DP2000	0,11	0,13	0,16	0,18	0,20	0,22	0,24	160
	P2 DP2000	0,0044	0,0050	0,0065	0,0070	0,0080	0,0085	0,0095	520
K5	P2 DP2000	0,10	0,11	0,14	0,16	0,18	0,19	0,22	95
	P2 DP2000	0,0040	0,0044	0,0055	0,0065	0,0070	0,0075	0,0085	310
N1	P1 T250D	0,12	0,14	0,17	0,20	0,22	0,24	0,26	310
	P1 T250D	0,0048	0,0055	0,0065	0,0080	0,0085	0,0095	0,010	1025
N2	P1 T250D	0,12	0,14	0,17	0,20	0,22	0,24	0,26	200
	P1 T250D	0,0048	0,0055	0,0065	0,0080	0,0085	0,0095	0,010	660
N3	P1 T250D	0,12	0,14	0,17	0,20	0,22	0,24	0,26	135
	P1 T250D	0,0048	0,0055	0,0065	0,0080	0,0085	0,0095	0,010	445
N11	P1 T250D	0,12	0,14	0,17	0,20	0,22	0,24	0,26	260
	P1 T250D	0,0048	0,0055	0,0065	0,0080	0,0085	0,0095	0,010	850
S1	MP DS2050	0,090	0,11	0,13	0,15	0,17	0,18	0,20	55
	MP DS2050	0,0036	0,0044	0,0050	0,0060	0,0065	0,0070	0,0080	180
S2	MP DS2050	0,090	0,11	0,13	0,15	0,17	0,18	0,20	43
	MP DS2050	0,0036	0,0044	0,0050	0,0060	0,0065	0,0070	0,0080	140
S3	MP DS2050	0,085	0,10	0,12	0,14	0,16	0,17	0,19	37
	MP DS2050	0,0034	0,0040	0,0048	0,0055	0,0065	0,0065	0,0075	120
S11	MP DS2050	0,11	0,12	0,15	0,17	0,19	0,20	0,24	75
	MP DS2050	0,0044	0,0048	0,0060	0,0065	0,0075	0,0080	0,0095	245
S12	MP DS2050	0,11	0,12	0,15	0,17	0,19	0,20	0,24	60
	MP DS2050	0,0044	0,0048	0,0060	0,0065	0,0075	0,0080	0,0095	195
S13	MP DS2050	0,090	0,11	0,13	0,15	0,17	0,18	0,20	45
	MP DS2050	0,0036	0,0044	0,0050	0,0060	0,0065	0,0070	0,0080	150
H3	P1 T250D	0,050	0,060	0,070	0,080	0,095	0,10	0,11	60
	P1 T250D	0,0020	0,0024	0,0028	0,0032	0,0038	0,0040	0,0044	195
H5	P1 T250D	0,075	0,090	0,11	0,12	0,14	0,15	0,17	110
	P1 T250D	0,0030	0,0036	0,0044	0,0048	0,0055	0,0060	0,0065	360
H7	P1 T250D	0,050	0,060	0,070	0,080	0,095	0,10	0,11	60
	P1 T250D	0,0020	0,0024	0,0028	0,0032	0,0038	0,0040	0,0044	195
H8	P1 T250D	0,060	0,070	0,085	0,095	0,11	0,11	0,13	110
	P1 T250D	0,0024	0,0028	0,0034	0,0038	0,0044	0,0044	0,0050	360
H11	P1 T250D	0,075	0,090	0,11	0,12	0,14	0,15	0,17	140
	P1 T250D	0,0030	0,0036	0,0044	0,0048	0,0055	0,0060	0,0065	460
H12	P1 T250D	0,060	0,070	0,085	0,095	0,11	0,11	0,13	130
	P1 T250D	0,0024	0,0028	0,0034	0,0038	0,0044	0,0044	0,0050	425
H21	P1 T250D	0,060	0,070	0,085	0,095	0,11	0,11	0,13	110
	P1 T250D	0,0024	0,0028	0,0034	0,0038	0,0044	0,0044	0,0050	360

SMG = Grupy materiałowe Seco f = mm/obr (cal/obr) v_c = m/min (stp/min) Wszystkie parametry są wartościami początkowymi

Wstęp

Wiercenie

Rozwiercanie

Wylaczanie

Zalacznik

SD523 Prędkość skrawania

SMG	v _c			
	DP2000	DP3000	T250D	DS2050
P1	415	370	265	370
	1350	1225	870	1225
P2	405	360	260	360
	1325	1175	850	1175
P3	345	310	225	310
	1125	1025	740	1025
P4	230	190	120	—
	750	620	395	—
P5	220	180	115	—
	720	590	375	—
P6	250	200	130	—
	820	660	425	—
P7	235	190	120	—
	770	620	395	—
P8	220	180	115	—
	720	590	375	—
P11	225	185	115	—
	740	610	375	—
P12	135	110	70	—
	445	360	230	—
M1	—	245	135	—
	—	800	445	—
M2	—	195	110	—
	—	640	360	—
M3	—	150	85	150
	—	490	280	490
M4	—	115	65	120
	—	375	215	395
M5	—	95	55	100
	—	310	180	330
K1	225	215	—	—
	740	710	—	—
K2	195	185	—	—
	640	610	—	—
K3	165	160	—	—
	540	520	—	—
K4	160	150	—	—
	520	490	—	—
K5	95	90	—	—
	310	295	—	—
N1	—	360	310	310
	—	1175	1025	1025
N2	—	230	200	200
	—	750	660	660
N3	—	155	135	135
	—	510	445	445
N11	—	300	260	260
	—	980	850	850
S1	—	—	34	55
	—	—	110	180
S2	—	—	25	43
	—	—	80	140
S3	—	—	25	37
	—	—	80	120
S11	—	—	65	75
	—	—	215	245
S12	—	—	50	60
	—	—	165	195
S13	—	—	39	45
	—	—	130	150
H3	—	60	60	—
	—	195	195	—
H5	—	115	110	—
	—	375	360	—
H7	—	60	60	—
	—	195	195	—
H8	—	115	110	—
	—	375	360	—
H11	—	145	140	—
	—	475	460	—
H12	—	65	130	—
	—	215	425	—
H21	—	115	110	—
	—	375	360	—

SMG = Grupy materiałowe Seco v_c = m/min (stp/min) Wszystkie parametry są wartościami początkowymi

Wstęp

Wiercenie

Rozwiercanie

Wytaczanie

Załącznik

SD524 Ø 17-60 mm / 0.590-2.375 cale

SMG		f							v _c
		Ø 15,00-19,49 Ø 0.590-0.767	Ø 19,50-22,49 Ø 0.768-0.885	Ø 22,50-28,49 Ø 0.886-1.121	Ø 28,50-34,49 Ø 1.122-1.357	Ø 34,50-40,49 Ø 1.358-1.593	Ø 40,49-44,49 Ø 1.594-1.751	Ø 44,50-59,99 Ø 1.752-2.375	
P1	P1 DP2000	0,060	0,070	0,085	0,095	0,11	0,12	0,13	380
	P1 DP2000	0,0024	0,0028	0,0034	0,0038	0,0044	0,0048	0,0050	1250
P2	P1 DP2000	0,060	0,070	0,085	0,10	0,11	0,12	0,13	370
	P1 DP2000	0,0024	0,0028	0,0034	0,0040	0,0044	0,0048	0,0050	1225
P3	P2 DP3000	0,12	0,14	0,17	0,19	0,22	0,22	0,26	285
	P2 DP3000	0,0048	0,0055	0,0065	0,0075	0,0085	0,0085	0,010	940
P4	P2 DP3000	0,12	0,13	0,16	0,19	0,22	0,22	0,25	165
	P2 DP3000	0,0048	0,0050	0,0065	0,0075	0,0085	0,0085	0,010	540
P5	P2 DP3000	0,11	0,13	0,16	0,18	0,20	0,22	0,25	160
	P2 DP3000	0,0044	0,0050	0,0065	0,0070	0,0080	0,0085	0,010	520
P6	P2 DP3000	0,11	0,13	0,16	0,18	0,20	0,22	0,25	180
	P2 DP3000	0,0044	0,0050	0,0065	0,0070	0,0080	0,0085	0,010	590
P7	P2 DP3000	0,11	0,13	0,16	0,18	0,20	0,22	0,25	170
	P2 DP3000	0,0044	0,0050	0,0065	0,0070	0,0080	0,0085	0,010	560
P8	P2 DP3000	0,12	0,14	0,17	0,19	0,22	0,22	0,26	160
	P2 DP3000	0,0048	0,0055	0,0065	0,0075	0,0085	0,0085	0,010	520
P11	P2 DP3000	0,11	0,13	0,16	0,18	0,20	0,22	0,25	165
	P2 DP3000	0,0044	0,0050	0,0065	0,0070	0,0080	0,0085	0,010	540
P12	P2 DP3000	0,075	0,090	0,11	0,12	0,14	0,15	0,17	95
	P2 DP3000	0,0030	0,0036	0,0044	0,0048	0,0055	0,0060	0,0065	310
M1	P2 DP3000	0,085	0,10	0,12	0,14	0,16	0,17	0,19	235
	P2 DP3000	0,0034	0,0040	0,0048	0,0055	0,0065	0,0065	0,0075	770
M2	P2 DP3000	0,080	0,090	0,11	0,13	0,14	0,15	0,17	190
	P2 DP3000	0,0032	0,0036	0,0044	0,0050	0,0055	0,0060	0,0065	620
M3	MP DS2050	0,065	0,075	0,090	0,10	0,12	0,13	0,14	145
	MP DS2050	0,0026	0,0030	0,0036	0,0040	0,0048	0,0050	0,0055	475
M4	MP DS2050	0,055	0,065	0,080	0,090	0,10	0,11	0,12	105
	MP DS2050	0,0022	0,0026	0,0032	0,0036	0,0040	0,0044	0,0048	345
M5	MP DS2050	0,055	0,065	0,080	0,090	0,10	0,11	0,12	90
	MP DS2050	0,0022	0,0026	0,0032	0,0036	0,0040	0,0044	0,0048	295
K1	P2 DP2000	0,12	0,14	0,17	0,20	0,22	0,24	0,26	210
	P2 DP2000	0,0048	0,0055	0,0065	0,0080	0,0085	0,0095	0,010	690
K2	P2 DP2000	0,11	0,13	0,16	0,18	0,20	0,22	0,24	180
	P2 DP2000	0,0044	0,0050	0,0065	0,0070	0,0080	0,0085	0,0095	590
K3	P2 DP2000	0,11	0,13	0,16	0,18	0,20	0,22	0,24	155
	P2 DP2000	0,0044	0,0050	0,0065	0,0070	0,0080	0,0085	0,0095	510
K4	P2 DP2000	0,11	0,13	0,16	0,18	0,20	0,22	0,24	145
	P2 DP2000	0,0044	0,0050	0,0065	0,0070	0,0080	0,0085	0,0095	475
K5	P2 DP2000	0,10	0,11	0,14	0,16	0,18	0,19	0,22	85
	P2 DP2000	0,0040	0,0044	0,0055	0,0065	0,0070	0,0075	0,0085	280
N1	P1 T250D	0,12	0,14	0,17	0,20	0,22	0,24	0,26	270
	P1 T250D	0,0048	0,0055	0,0065	0,0080	0,0085	0,0095	0,010	890
N2	P1 T250D	0,12	0,14	0,17	0,20	0,22	0,24	0,26	175
	P1 T250D	0,0048	0,0055	0,0065	0,0080	0,0085	0,0095	0,010	570
N3	P1 T250D	0,12	0,14	0,17	0,20	0,22	0,24	0,26	115
	P1 T250D	0,0048	0,0055	0,0065	0,0080	0,0085	0,0095	0,010	375
N11	P1 T250D	0,12	0,14	0,17	0,20	0,22	0,24	0,26	230
	P1 T250D	0,0048	0,0055	0,0065	0,0080	0,0085	0,0095	0,010	750
S1	MP DS2050	0,090	0,11	0,13	0,15	0,17	0,18	0,20	48
	MP DS2050	0,0036	0,0044	0,0050	0,0060	0,0065	0,0070	0,0080	155
S2	MP DS2050	0,090	0,11	0,13	0,15	0,17	0,18	0,20	39
	MP DS2050	0,0036	0,0044	0,0050	0,0060	0,0065	0,0070	0,0080	130
S3	MP DS2050	0,085	0,10	0,12	0,14	0,16	0,17	0,19	33
	MP DS2050	0,0034	0,0040	0,0048	0,0055	0,0065	0,0065	0,0075	110
S11	MP DS2050	0,11	0,12	0,15	0,17	0,19	0,20	0,24	70
	MP DS2050	0,0044	0,0048	0,0060	0,0065	0,0075	0,0080	0,0095	230
S12	MP DS2050	0,11	0,12	0,15	0,17	0,19	0,20	0,24	55
	MP DS2050	0,0044	0,0048	0,0060	0,0065	0,0075	0,0080	0,0095	180
S13	MP DS2050	0,090	0,11	0,13	0,15	0,17	0,18	0,20	41
	MP DS2050	0,0036	0,0044	0,0050	0,0060	0,0065	0,0070	0,0080	135
H3	P1 T250D	0,050	0,060	0,070	0,080	0,095	0,10	0,11	50
	P1 T250D	0,0020	0,0024	0,0028	0,0032	0,0038	0,0040	0,0044	165
H5	P1 T250D	0,075	0,090	0,11	0,12	0,14	0,15	0,17	95
	P1 T250D	0,0030	0,0036	0,0044	0,0048	0,0055	0,0060	0,0065	310
H7	P1 T250D	0,050	0,060	0,070	0,080	0,095	0,10	0,11	50
	P1 T250D	0,0020	0,0024	0,0028	0,0032	0,0038	0,0040	0,0044	165
H8	P1 T250D	0,060	0,070	0,085	0,095	0,11	0,11	0,13	95
	P1 T250D	0,0024	0,0028	0,0034	0,0038	0,0044	0,0044	0,0050	310
H11	P1 T250D	0,075	0,090	0,11	0,12	0,14	0,15	0,17	125
	P1 T250D	0,0030	0,0036	0,0044	0,0048	0,0055	0,0060	0,0065	410
H12	P1 T250D	0,060	0,070	0,085	0,095	0,11	0,11	0,13	110
	P1 T250D	0,0024	0,0028	0,0034	0,0038	0,0044	0,0044	0,0050	360
H21	P1 T250D	0,060	0,070	0,085	0,095	0,11	0,11	0,13	95
	P1 T250D	0,0024	0,0028	0,0034	0,0038	0,0044	0,0044	0,0050	310

SMG = Grupy materiałowe Seco f = mm/obr (cal/obr) v_c = m/min (stp/min) Wszystkie parametry są wartościami początkowymi

Wstęp

Wiercenie

Rozwiercanie

Wylaczanie

Zalacznik

SD524 Prędkość skrawania

SMG	v _c			
	DP2000	DP3000	T250D	DS2050
P1	380	340	230	340
	1250	1125	750	1125
P2	370	330	225	330
	1225	1075	740	1075
P3	320	285	195	285
	1050	940	640	940
P4	195	165	105	—
	640	540	345	—
P5	185	160	100	—
	610	520	330	—
P6	210	180	110	—
	690	590	360	—
P7	195	170	105	—
	640	560	345	—
P8	185	160	100	—
	610	520	330	—
P11	190	165	100	—
	620	540	330	—
P12	110	95	60	—
	360	310	195	—
M1	—	235	120	—
	—	770	395	—
M2	—	190	95	—
	—	620	310	—
M3	—	145	75	145
	—	475	245	475
M4	—	110	55	105
	—	360	180	345
M5	—	90	46	90
	—	295	150	295
K1	210	200	—	—
	690	660	—	—
K2	180	170	—	—
	590	560	—	—
K3	155	145	—	—
	510	475	—	—
K4	145	140	—	—
	475	460	—	—
K5	85	85	—	—
	280	280	—	—
N1	—	315	270	270
	—	1025	890	890
N2	—	205	175	175
	—	670	570	570
N3	—	135	115	115
	—	445	375	375
N11	—	265	230	230
	—	870	750	750
S1	—	—	29	48
	—	—	95	155
S2	—	—	22	39
	—	—	70	130
S3	—	—	22	33
	—	—	70	110
S11	—	—	55	70
	—	—	180	230
S12	—	—	44	55
	—	—	145	180
S13	—	—	34	41
	—	—	110	135
H3	—	55	50	—
	—	180	165	—
H5	—	100	95	—
	—	330	310	—
H7	—	55	50	—
	—	180	165	—
H8	—	100	95	—
	—	330	310	—
H11	—	125	125	—
	—	410	410	—
H12	—	55	110	—
	—	180	360	—
H21	—	100	95	—
	—	330	310	—

SMG = Grupy materiałowe Seco v_c = m/min (stp/min) Wszystkie parametry są wartościami początkowymi

SMG		f					v _c
		Ø 19,50-22,49 Ø 0.768-0.885	Ø 22,50-28,49 Ø 0.886-1.121	Ø 28,50-34,49 Ø 1.122-1.357	Ø 34,50-40,49 Ø 1.358-1.593	Ø 40,49-45,00 Ø 1.594-2.000	
P1	P2 DP3000	0,070	0,085	0,095	0,11	0,12	320
	P2 DP3000	0.0028	0.0034	0.0038	0.0044	0.0048	1050
P2	P2 DP3000	0,070	0,085	0,10	0,11	0,12	310
	P2 DP3000	0.0028	0.0034	0.0040	0.0044	0.0048	1025
P3	P2 DP3000	0,14	0,17	0,19	0,22	0,22	265
	P2 DP3000	0.0055	0.0065	0.0075	0.0085	0.0085	870
P4	P2 DP3000	0,13	0,16	0,19	0,22	0,22	150
	P2 DP3000	0.0050	0.0065	0.0075	0.0085	0.0085	490
P5	P2 DP3000	0,13	0,16	0,18	0,20	0,22	140
	P2 DP3000	0.0050	0.0065	0.0070	0.0080	0.0085	460
P6	P2 DP3000	0,13	0,16	0,18	0,20	0,22	160
	P2 DP3000	0.0050	0.0065	0.0070	0.0080	0.0085	520
P7	P2 DP3000	0,13	0,16	0,18	0,20	0,22	150
	P2 DP3000	0.0050	0.0065	0.0070	0.0080	0.0085	490
P8	P2 DP3000	0,14	0,17	0,19	0,22	0,22	140
	P2 DP3000	0.0055	0.0065	0.0075	0.0085	0.0085	460
P11	P2 DP3000	0,13	0,16	0,18	0,20	0,22	145
	P2 DP3000	0.0050	0.0065	0.0070	0.0080	0.0085	475
P12	P2 DP3000	0,090	0,11	0,12	0,14	0,15	85
	P2 DP3000	0.0036	0.0044	0.0048	0.0055	0.0060	280
M1	P2 DP3000	0,10	0,12	0,14	0,16	0,17	225
	P2 DP3000	0.0040	0.0048	0.0055	0.0065	0.0065	740
M2	P2 DP3000	0,090	0,11	0,13	0,14	0,15	180
	P2 DP3000	0.0036	0.0044	0.0050	0.0055	0.0060	590
M3	MP DS2050	0,075	0,090	0,10	0,12	0,13	140
	MP DS2050	0.0030	0.0036	0.0040	0.0048	0.0050	460
M4	MP DS2050	0,065	0,080	0,090	0,10	0,11	95
	MP DS2050	0.0026	0.0032	0.0036	0.0040	0.0044	310
M5	MP DS2050	0,065	0,080	0,090	0,10	0,11	80
	MP DS2050	0.0026	0.0032	0.0036	0.0040	0.0044	260
K1	P2 DP3000	0,14	0,17	0,20	0,22	0,24	185
	P2 DP3000	0.0055	0.0065	0.0080	0.0085	0.0095	610
K2	P2 DP3000	0,13	0,16	0,18	0,20	0,22	160
	P2 DP3000	0.0050	0.0065	0.0070	0.0080	0.0085	520
K3	P2 DP3000	0,13	0,16	0,18	0,20	0,22	135
	P2 DP3000	0.0050	0.0065	0.0070	0.0080	0.0085	445
K4	P2 DP3000	0,13	0,16	0,18	0,20	0,22	130
	P2 DP3000	0.0050	0.0065	0.0070	0.0080	0.0085	425
K5	P2 DP3000	0,11	0,14	0,16	0,18	0,19	80
	P2 DP3000	0.0044	0.0055	0.0065	0.0070	0.0075	260
N1	P1 T250D	0,14	0,17	0,20	0,22	0,24	240
	P1 T250D	0.0055	0.0065	0.0080	0.0085	0.0095	790
N2	P1 T250D	0,14	0,17	0,20	0,22	0,24	155
	P1 T250D	0.0055	0.0065	0.0080	0.0085	0.0095	510
N3	P1 T250D	0,14	0,17	0,20	0,22	0,24	100
	P1 T250D	0.0055	0.0065	0.0080	0.0085	0.0095	330
N11	P1 T250D	0,14	0,17	0,20	0,22	0,24	200
	P1 T250D	0.0055	0.0065	0.0080	0.0085	0.0095	660
S1	MP DS2050	0,11	0,13	0,15	0,17	0,18	44
	MP DS2050	0.0044	0.0050	0.0060	0.0065	0.0070	145
S2	MP DS2050	0,11	0,13	0,15	0,17	0,18	36
	MP DS2050	0.0044	0.0050	0.0060	0.0065	0.0070	120
S3	MP DS2050	0,10	0,12	0,14	0,16	0,17	31
	MP DS2050	0.0040	0.0048	0.0055	0.0065	0.0065	100
S11	MP DS2050	0,12	0,15	0,17	0,19	0,20	65
	MP DS2050	0.0048	0.0060	0.0065	0.0075	0.0080	215
S12	MP DS2050	0,12	0,15	0,17	0,19	0,20	49
	MP DS2050	0.0048	0.0060	0.0065	0.0075	0.0080	160
S13	MP DS2050	0,11	0,13	0,15	0,17	0,18	38
	MP DS2050	0.0044	0.0050	0.0060	0.0065	0.0070	125
H3	P1 T250D	0,060	0,070	0,085	0,095	0,10	46
	P1 T250D	0.0024	0.0028	0.0034	0.0038	0.0040	150
H5	P1 T250D	0,090	0,11	0,12	0,14	0,15	85
	P1 T250D	0.0036	0.0044	0.0048	0.0055	0.0060	280
H7	P1 T250D	0,060	0,070	0,085	0,095	0,10	46
	P1 T250D	0.0024	0.0028	0.0034	0.0038	0.0040	150
H8	P1 T250D	0,070	0,085	0,095	0,11	0,11	85
	P1 T250D	0.0028	0.0034	0.0038	0.0044	0.0044	280
H11	P1 T250D	0,090	0,11	0,12	0,14	0,15	110
	P1 T250D	0.0036	0.0044	0.0048	0.0055	0.0060	360
H12	P1 T250D	0,070	0,085	0,095	0,11	0,11	100
	P1 T250D	0.0028	0.0034	0.0038	0.0044	0.0044	330
H21	P1 T250D	0,070	0,085	0,095	0,11	0,11	85
	P1 T250D	0.0028	0.0034	0.0038	0.0044	0.0044	280

SMG = Grupy materiałowe Seco f = mm/obr (cal/obr) v_c = m/min (stp/min) Wszystkie parametry są wartościami początkowymi

Wstęp

Wiercenie

Rozwiercanie

Wyłaczanie

Załącznik

SD525 Prędkość skrawania

SMG	v _c			
	DP2000	DP3000	T250D	DS2050
P1	355	320	205	320
	1175	1050	670	1050
P2	345	310	200	310
	1125	1025	660	1025
P3	295	265	170	265
	970	870	560	870
P4	165	150	90	—
	540	490	295	—
P5	155	140	90	—
	510	460	295	—
P6	175	160	100	—
	570	520	330	—
P7	165	150	95	—
	540	490	310	—
P8	155	140	90	—
	510	460	295	—
P11	160	145	90	—
	520	475	295	—
P12	95	85	55	—
	310	280	180	—
M1	—	225	105	—
	—	740	345	—
M2	—	180	85	—
	—	590	280	—
M3	—	140	65	140
	—	460	215	460
M4	—	105	49	95
	—	345	160	310
M5	—	85	41	80
	—	280	135	260
K1	195	185	—	—
	640	610	—	—
K2	170	160	—	—
	560	520	—	—
K3	145	135	—	—
	475	445	—	—
K4	140	130	—	—
	460	425	—	—
K5	80	80	—	—
	260	260	—	—
N1	—	285	240	240
	—	940	790	790
N2	—	185	155	155
	—	610	510	510
N3	—	120	100	100
	—	395	330	330
N11	—	235	200	200
	—	770	660	660
S1	—	—	26	44
	—	—	85	145
S2	—	—	20	36
	—	—	65	120
S3	—	—	20	31
	—	—	65	100
S11	—	—	50	65
	—	—	165	215
S12	—	—	39	49
	—	—	130	160
S13	—	—	30	38
	—	—	100	125
H3	—	48	46	—
	—	155	150	—
H5	—	90	85	—
	—	295	280	—
H7	—	48	46	—
	—	155	150	—
H8	—	90	85	—
	—	295	280	—
H11	—	115	110	—
	—	375	360	—
H12	—	50	100	—
	—	165	330	—
H21	—	90	85	—
	—	295	280	—

SMG = Grupy materiałowe Seco v_c = m/min (stp/min) Wszystkie parametry są wartościami początkowymi

Wstęp

Wiercenie

Rozwiercanie

Wytaczanie

Załącznik

SD542 Ø 60-85 mm / 2.250-3.500 cal

SMG		f		v _c
		Ø 60,00-65,00 Ø 2.250-2.559	Ø 70,00-85,00 Ø 2.750-3.500	
P1	P2 DP3000	0,095	0,12	390
	P2 DP3000	0.0038	0.0048	1275
P2	P2 DP3000	0,10	0,12	380
	P2 DP3000	0.0040	0.0048	1250
P3	P2 DP3000	0,19	0,22	325
	P2 DP3000	0.0075	0.0085	1075
P4	P2 DP3000	0,19	0,22	205
	P2 DP3000	0.0075	0.0085	670
P5	P2 DP3000	0,18	0,22	195
	P2 DP3000	0.0070	0.0085	640
P6	P2 DP3000	0,18	0,22	220
	P2 DP3000	0.0070	0.0085	720
P7	P2 DP3000	0,18	0,22	205
	P2 DP3000	0.0070	0.0085	670
P8	P2 DP3000	0,19	0,22	195
	P2 DP3000	0.0075	0.0085	640
P11	P2 DP3000	0,18	0,22	200
	P2 DP3000	0.0070	0.0085	660
P12	P2 DP3000	0,12	0,15	120
	P2 DP3000	0.0048	0.0060	395
M1	P2 DP3000	0,14	0,17	250
	P2 DP3000	0.0055	0.0065	820
M2	P2 DP3000	0,13	0,15	205
	P2 DP3000	0.0050	0.0060	670
M3	P1 T250D	0,10	0,12	90
	P1 T250D	0.0040	0.0048	295
M4	P1 T250D	0,090	0,11	70
	P1 T250D	0.0036	0.0044	230
M5	P1 T250D	0,090	0,11	55
	P1 T250D	0.0036	0.0044	180
K1	P2 DP3000	0,20	0,24	225
	P2 DP3000	0.0080	0.0095	740
K2	P2 DP3000	0,18	0,22	195
	P2 DP3000	0.0070	0.0085	640
K3	P2 DP3000	0,18	0,22	165
	P2 DP3000	0.0070	0.0085	540
K4	P2 DP3000	0,18	0,22	160
	P2 DP3000	0.0070	0.0085	520
K5	P2 DP3000	0,16	0,19	95
	P2 DP3000	0.0065	0.0075	310
N1	P1 T250D	0,20	0,24	335
	P1 T250D	0.0080	0.0095	1100
N2	P1 T250D	0,20	0,24	215
	P1 T250D	0.0080	0.0095	710
N3	P1 T250D	0,20	0,24	145
	P1 T250D	0.0080	0.0095	475
N11	P1 T250D	0,20	0,24	285
	P1 T250D	0.0080	0.0095	940
S1	MP DS2050	0,15	0,18	55
	MP DS2050	0.0060	0.0070	180
S2	MP DS2050	0,15	0,18	45
	MP DS2050	0.0060	0.0070	150
S3	MP DS2050	0,14	0,17	39
	MP DS2050	0.0055	0.0065	130
S11	MP DS2050	0,17	0,20	80
	MP DS2050	0.0065	0.0080	260
S12	MP DS2050	0,17	0,20	60
	MP DS2050	0.0065	0.0080	195
S13	MP DS2050	0,15	0,18	48
	MP DS2050	0.0060	0.0070	155
H3	P1 T250D	0,080	0,10	65
	P1 T250D	0.0032	0.0040	215
H5	P1 T250D	0,12	0,15	120
	P1 T250D	0.0048	0.0060	395
H7	P1 T250D	0,080	0,10	65
	P1 T250D	0.0032	0.0040	215
H8	P1 T250D	0,095	0,11	120
	P1 T250D	0.0038	0.0044	395
H11	P1 T250D	0,12	0,15	155
	P1 T250D	0.0048	0.0060	510
H12	P1 T250D	0,095	0,11	140
	P1 T250D	0.0038	0.0044	460
H21	P1 T250D	0,095	0,11	120
	P1 T250D	0.0038	0.0044	395

SMG = Grupy materiałowe Seco f = mm/obr (cal/obr) v_c = m/min (stp/min) Wszystkie parametry są wartościami początkowymi

Wstęp

Wiercenie

Rozwiercanie

Wyłaczanie

Załącznik

SD542 Prędkość skrawania

SMG	v _c			
	DP2000	DP3000	T250D	DS2050
P1	435	390	290	390
	1425	1275	950	1275
P2	425	380	280	380
	1400	1250	920	1250
P3	365	325	240	325
	1200	1075	790	1075
P4	255	205	130	—
	840	670	425	—
P5	245	195	125	—
	800	640	410	—
P6	275	220	140	—
	900	720	460	—
P7	260	205	130	—
	850	670	425	—
P8	245	195	125	—
	800	640	410	—
P11	250	200	125	—
	820	660	410	—
P12	150	120	75	—
	490	395	245	—
M1	—	250	150	—
	—	820	490	—
M2	—	205	120	—
	—	670	395	—
M3	—	155	90	155
	—	510	295	510
M4	—	115	70	130
	—	375	230	425
M5	—	95	55	105
	—	310	180	345
K1	235	225	—	—
	770	740	—	—
K2	205	195	—	—
	670	640	—	—
K3	175	165	—	—
	570	540	—	—
K4	165	160	—	—
	540	520	—	—
K5	100	95	—	—
	330	310	—	—
N1	—	390	335	335
	—	1275	1100	1100
N2	—	250	215	215
	—	820	710	710
N3	—	165	145	145
	—	540	475	475
N11	—	325	285	285
	—	1075	940	940
S1	—	—	37	55
	—	—	120	180
S2	—	—	27	45
	—	—	90	150
S3	—	—	27	39
	—	—	90	130
S11	—	—	70	80
	—	—	230	260
S12	—	—	55	60
	—	—	180	195
S13	—	—	43	48
	—	—	140	155
H3	—	65	65	—
	—	215	215	—
H5	—	120	120	—
	—	395	395	—
H7	—	65	65	—
	—	215	215	—
H8	—	120	120	—
	—	395	395	—
H11	—	155	155	—
	—	510	510	—
H12	—	70	140	—
	—	230	460	—
H21	—	120	120	—
	—	395	395	—

SMG = Grupy materiałowe Seco v_c = m/min (stp/min) Wszystkie parametry są wartościami początkowymi

Wstęp

Wiercenie

Rozwiercanie

Wytaczanie

Załącznik

SMG		f						v _c
		Ø 15,00-17,00 Ø 0.590-0.669	Ø 18,00-20,00 Ø 0.670-0.787	Ø 21,00-24,00 Ø 0.788-0.944	Ø 25,00-32,00 Ø 0.945-1.259	Ø 33,00-36,00 Ø 1.260-1.417	Ø 37,00-52,00 Ø 1.418-1.850	
P1	85 DP3000	0,042	0,042	0,048	0,060	0,070	0,085	310
	85 DP3000	0.0017	0.0017	0.0019	0.0024	0.0028	0.0034	1025
P2	85 DP3000	0,042	0,042	0,050	0,060	0,070	0,085	305
	85 DP3000	0.0017	0.0017	0.0020	0.0024	0.0028	0.0034	1000
P3	86 DP3000	0,12	0,12	0,13	0,17	0,19	0,22	260
	86 DP3000	0.0048	0.0048	0.0050	0.0065	0.0075	0.0085	850
P4	86 DP3000	0,11	0,11	0,13	0,16	0,19	0,22	230
	86 DP3000	0.0044	0.0044	0.0050	0.0065	0.0075	0.0085	750
P5	86 DP3000	0,11	0,11	0,13	0,16	0,18	0,22	220
	86 DP3000	0.0044	0.0044	0.0050	0.0065	0.0070	0.0085	720
P6	86 DP3000	0,11	0,11	0,13	0,16	0,18	0,22	245
	86 DP3000	0.0044	0.0044	0.0050	0.0065	0.0070	0.0085	800
P7	86 DP3000	0,11	0,11	0,13	0,16	0,18	0,22	235
	86 DP3000	0.0044	0.0044	0.0050	0.0065	0.0070	0.0085	770
P8	86 DP3000	0,12	0,12	0,13	0,17	0,19	0,22	220
	86 DP3000	0.0048	0.0048	0.0050	0.0065	0.0075	0.0085	720
P11	86 DP3000	0,11	0,11	0,13	0,16	0,18	0,22	225
	86 DP3000	0.0044	0.0044	0.0050	0.0065	0.0070	0.0085	740
P12	86 DP3000	0,075	0,075	0,085	0,11	0,12	0,15	135
	86 DP3000	0.0030	0.0030	0.0034	0.0044	0.0048	0.0060	445
M1	86 DP3000	0,075	0,075	0,085	0,11	0,12	0,15	235
	86 DP3000	0.0030	0.0030	0.0034	0.0044	0.0048	0.0060	770
M2	86 DP3000	0,070	0,070	0,080	0,10	0,11	0,14	190
	86 DP3000	0.0028	0.0028	0.0032	0.0040	0.0044	0.0055	620
M3	85 DP3000	0,034	0,034	0,040	0,048	0,055	0,070	145
	85 DP3000	0.0013	0.0013	0.0016	0.0019	0.0022	0.0028	475
M4	85 DP3000	0,030	0,030	0,034	0,042	0,050	0,060	110
	85 DP3000	0.0012	0.0012	0.0013	0.0017	0.0020	0.0024	360
M5	85 DP3000	0,030	0,030	0,034	0,042	0,050	0,060	90
	85 DP3000	0.0012	0.0012	0.0013	0.0017	0.0020	0.0024	295
K1	86 DP3000	0,12	0,12	0,14	0,17	0,20	0,24	180
	86 DP3000	0.0048	0.0048	0.0055	0.0065	0.0080	0.0095	590
K2	86 DP3000	0,11	0,11	0,13	0,16	0,18	0,22	155
	86 DP3000	0.0044	0.0044	0.0050	0.0065	0.0070	0.0085	510
K3	86 DP3000	0,11	0,11	0,13	0,16	0,18	0,22	130
	86 DP3000	0.0044	0.0044	0.0050	0.0065	0.0070	0.0085	425
K4	86 DP3000	0,11	0,11	0,13	0,16	0,18	0,22	125
	86 DP3000	0.0044	0.0044	0.0050	0.0065	0.0070	0.0085	410
K5	86 DP3000	0,10	0,10	0,11	0,14	0,16	0,19	75
	86 DP3000	0.0040	0.0040	0.0044	0.0055	0.0065	0.0075	245
S1	85 DP3000	0,055	0,055	0,060	0,075	0,090	0,11	40
	85 DP3000	0.0022	0.0022	0.0024	0.0030	0.0036	0.0044	130
S2	85 DP3000	0,055	0,055	0,060	0,075	0,090	0,11	30
	85 DP3000	0.0022	0.0022	0.0024	0.0030	0.0036	0.0044	100
S3	85 DP3000	0,050	0,050	0,060	0,070	0,085	0,10	30
	85 DP3000	0.0020	0.0020	0.0024	0.0028	0.0034	0.0040	100
S11	85 DP3000	0,060	0,060	0,070	0,090	0,10	0,12	80
	85 DP3000	0.0024	0.0024	0.0028	0.0036	0.0040	0.0048	260
S12	85 DP3000	0,060	0,060	0,070	0,090	0,10	0,12	60
	85 DP3000	0.0024	0.0024	0.0028	0.0036	0.0040	0.0048	195
S13	85 DP3000	0,055	0,055	0,060	0,075	0,090	0,11	47
	85 DP3000	0.0022	0.0022	0.0024	0.0030	0.0036	0.0044	155
H3	86 DP3000	0,050	0,050	0,060	0,070	0,085	0,10	80
	86 DP3000	0.0020	0.0020	0.0024	0.0028	0.0034	0.0040	260
H5	86 DP3000	0,075	0,075	0,085	0,11	0,12	0,15	150
	86 DP3000	0.0030	0.0030	0.0034	0.0044	0.0048	0.0060	490
H7	86 DP3000	0,050	0,050	0,060	0,070	0,085	0,10	80
	86 DP3000	0.0020	0.0020	0.0024	0.0028	0.0034	0.0040	260
H8	86 DP3000	0,060	0,060	0,065	0,085	0,095	0,11	150
	86 DP3000	0.0024	0.0024	0.0026	0.0034	0.0038	0.0044	490
H11	86 DP3000	0,075	0,075	0,085	0,11	0,12	0,15	195
	86 DP3000	0.0030	0.0030	0.0034	0.0044	0.0048	0.0060	640
H12	86 DP3000	0,060	0,060	0,065	0,085	0,095	0,11	80
	86 DP3000	0.0024	0.0024	0.0026	0.0034	0.0038	0.0044	260
H21	86 DP3000	0,060	0,060	0,065	0,085	0,095	0,11	150
	86 DP3000	0.0024	0.0024	0.0026	0.0034	0.0038	0.0044	490

SMG = Grupy materiałowe Seco f = mm/obr (cal/obr) v_c = m/min (stp/min) Wszystkie parametry są wartościami początkowymi

Wstęp

Wiercenie

Rozwiercanie

Wyłaczanie

Załącznik

SD572 Prędkość skrawania

SMG	v_c		
	DP2000		
Wstęp	P1	375 1225	
	P2	365 1200	
	P3	315 1025	
	P4	280 920	
	P5	265 870	
	P6	300 980	
	P7	280 920	
	P8	265 870	
	P11	275 900	
	P12	160 520	
	Wiercenie	M1	285 940
		M2	230 750
M3		175 570	
M4		130 425	
M5		110 360	
Rozwiercanie		K1	215 710
		K2	185 610
		K3	160 520
		K4	150 490
		K5	90 295
Wytaczanie		S1	—
		S2	—
	S3	—	
	S11	—	
	S12	—	
	S13	—	
	H3	80 260	
	H5	150 490	
	H7	80 260	
	H8	150 490	
	H11	195 640	
	Załącznik	H12	95 310
H21		150 490	

SMG = Grupy materiałowe Seco v_c = m/min (stp/min) Wszystkie parametry są wartościami początkowymi

SMG		f					v _c
		Ø 60,00-69,99 Ø 2.362-2.755	Ø 70,00-91,99 Ø 2.756-3.621	Ø 92,00-110,99 Ø 3.622-4.369	Ø 111,00-134,99 Ø 4.370-4.314	Ø 135,00-160,00 Ø 4.315-6.300	
P1	P2 DP3000	0,085	0,095	0,12	0,13	0,12	295
	P2 DP3000	0.0034	0.0038	0.0048	0.0050	0.0048	970
P2	P2 DP3000	0,085	0,10	0,12	0,13	0,12	285
	P2 DP3000	0.0034	0.0040	0.0048	0.0050	0.0048	940
P3	P2 DP3000	0,17	0,19	0,22	0,26	0,22	245
	P2 DP3000	0.0065	0.0075	0.0085	0.010	0.0085	800
P4	P2 DP3000	0,16	0,19	0,22	0,25	0,22	130
	P2 DP3000	0.0065	0.0075	0.0085	0.010	0.0085	425
P5	P2 DP3000	0,16	0,18	0,22	0,25	0,22	125
	P2 DP3000	0.0065	0.0070	0.0085	0.010	0.0085	410
P6	P2 DP3000	0,16	0,18	0,22	0,25	0,22	140
	P2 DP3000	0.0065	0.0070	0.0085	0.010	0.0085	460
P7	P2 DP3000	0,16	0,18	0,22	0,25	0,22	135
	P2 DP3000	0.0065	0.0070	0.0085	0.010	0.0085	445
P8	P2 DP3000	0,17	0,19	0,22	0,26	0,22	125
	P2 DP3000	0.0065	0.0075	0.0085	0.010	0.0085	410
P11	P2 DP3000	0,16	0,18	0,22	0,25	0,22	130
	P2 DP3000	0.0065	0.0070	0.0085	0.010	0.0085	425
P12	P2 DP3000	0,11	0,12	0,15	0,17	0,15	75
	P2 DP3000	0.0044	0.0048	0.0060	0.0065	0.0060	245
M1	P2 DP3000	0,12	0,14	0,17	0,19	0,17	215
	P2 DP3000	0.0048	0.0055	0.0065	0.0075	0.0065	710
M2	P2 DP3000	0,11	0,13	0,15	0,17	0,15	175
	P2 DP3000	0.0044	0.0050	0.0060	0.0065	0.0060	570
M3	P1 DP3000	0,090	0,10	0,12	0,14	0,12	135
	P1 DP3000	0.0036	0.0040	0.0048	0.0055	0.0048	445
M4	P1 DP3000	0,075	0,090	0,11	0,12	0,11	100
	P1 DP3000	0.0030	0.0036	0.0044	0.0048	0.0044	330
M5	P1 DP3000	0,075	0,090	0,11	0,12	0,11	85
	P1 DP3000	0.0030	0.0036	0.0044	0.0048	0.0044	280
K1	P2 DP3000	0,17	0,20	0,24	0,26	0,24	175
	P2 DP3000	0.0065	0.0080	0.0095	0.010	0.0095	570
K2	P2 DP3000	0,16	0,18	0,22	0,24	0,22	150
	P2 DP3000	0.0065	0.0070	0.0085	0.0095	0.0085	490
K3	P2 DP3000	0,16	0,18	0,22	0,24	0,22	130
	P2 DP3000	0.0065	0.0070	0.0085	0.0095	0.0085	425
K4	P2 DP3000	0,16	0,18	0,22	0,24	0,22	120
	P2 DP3000	0.0065	0.0070	0.0085	0.0095	0.0085	395
K5	P2 DP3000	0,14	0,16	0,19	0,22	0,19	75
	P2 DP3000	0.0055	0.0065	0.0075	0.0085	0.0075	245
H3	P2 DP3000	0,070	0,080	0,10	0,11	0,10	42
	P2 DP3000	0.0028	0.0032	0.0040	0.0044	0.0040	140
H5	P2 DP3000	0,11	0,12	0,15	0,17	0,15	80
	P2 DP3000	0.0044	0.0048	0.0060	0.0065	0.0060	260
H7	P2 DP3000	0,070	0,080	0,10	0,11	0,10	42
	P2 DP3000	0.0028	0.0032	0.0040	0.0044	0.0040	140
H8	P2 DP3000	0,085	0,095	0,11	0,13	0,11	80
	P2 DP3000	0.0034	0.0038	0.0044	0.0050	0.0044	260
H11	P2 DP3000	0,11	0,12	0,15	0,17	0,15	100
	P2 DP3000	0.0044	0.0048	0.0060	0.0065	0.0060	330
H12	P2 DP3000	0,085	0,095	0,11	0,13	0,11	45
	P2 DP3000	0.0034	0.0038	0.0044	0.0050	0.0044	150
H21	P2 DP3000	0,085	0,095	0,11	0,13	0,11	80
	P2 DP3000	0.0034	0.0038	0.0044	0.0050	0.0044	260

SMG = Grupy materiałowe Seco f = mm/obr (cal/obr) v_c = m/min (stp/min) Wszystkie parametry są wartościami początkowymi

SD602 Prędkość skrawania

SMG	v _c	
	T250D	DS2050
P1	180	295
	590	970
P2	175	285
	570	940
P3	150	245
	490	800
P4	80	—
	260	—
P5	75	—
	245	—
P6	85	—
	280	—
P7	80	—
	260	—
P8	75	—
	245	—
P11	80	—
	260	—
P12	46	—
	150	—
M1	90	—
	295	—
M2	75	—
	245	—
M3	55	135
	180	445
M4	43	85
	140	280
M5	36	70
	120	230
K1	—	—
	—	—
K2	—	—
	—	—
K3	—	—
	—	—
K4	—	—
	—	—
K5	—	—
	—	—
H3	40	—
	130	—
H5	75	—
	245	—
H7	40	—
	130	—
H8	75	—
	245	—
H11	95	—
	310	—
H12	85	—
	280	—
H21	75	—
	245	—

SMG = Grupy materiałowe Seco v_c= m/min (stp/min) Wszystkie parametry są wartościami początkowymi

Wstęp

Wiercenie

Rozwiercanie

Wyłaczanie

Załącznik

Parametry skrawania SD522, SD523, SD524, SD525, SD542 i SD572 - Zużycie energii, zapotrzebowanie na objętość chłodziwa i wykresy siły

Wartości z wykresów mogą ulegać zmianie, zależnie od parametrów, materiału, wydajności obrabiarki i zużycia narzędzia.

Poniższe wykresy obowiązują dla grupy materiału P5-P6 i prędkości skrawania 200 m/min (655 sf/min).

Siła od posuwu

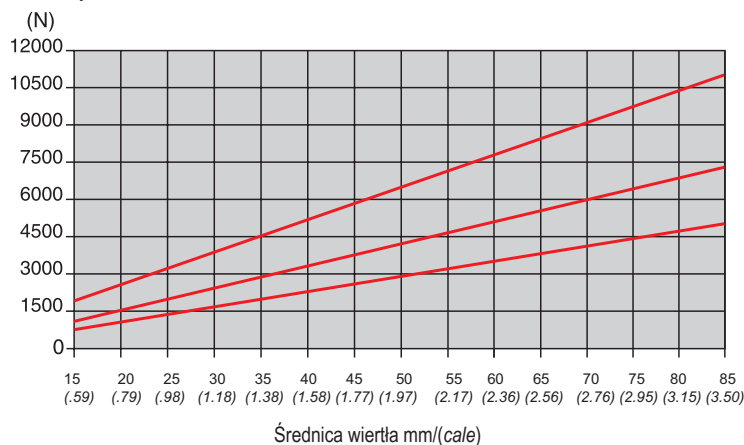

f = 0,18 mm/obr
(f = 0.007 cal/obr)

f = 0,12 mm/obr
(f = 0.005 cal/obr)

f = 0,08 mm/obr
(f = 0.003 cal/obr)

Zapotrzebowanie na moc

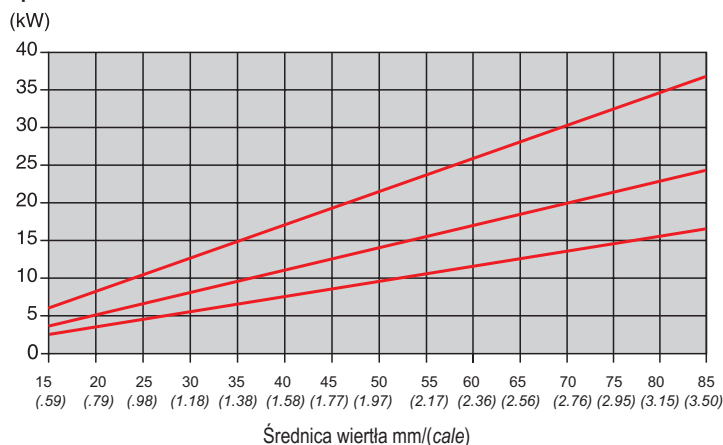

f = 0,18 mm/obr
(f = 0.007 cal/obr)

f = 0,12 mm/obr
(f = 0.005 cal/obr)

f = 0,08 mm/obr
(f = 0.003 cal/obr)

Moment obrotowy

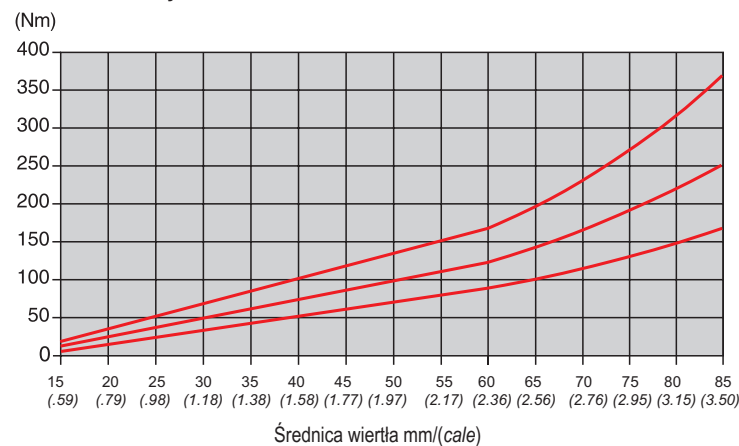

f = 0,18 mm/obr
(f = 0.007 cal/obr)

f = 0,12 mm/obr
(f = 0.005 cal/obr)

f = 0,08 mm/obr
(f = 0.003 cal/obr)

Parametry skrawania

Zapotrzebowanie na chłodziwo

Litry/minutę (galony/minutę)

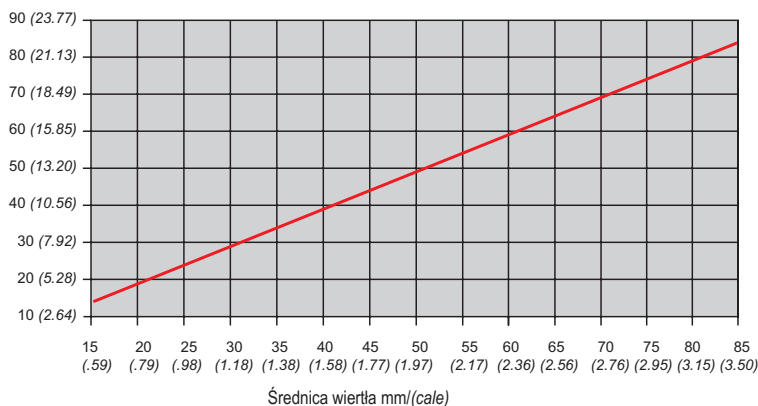

Wymagane ciśnienie chłodziwa

Zalecane ciśnienie w barach (PSI)

Głębokość wiercenia	Średnica wiertła mm (cale)		
	15–25 (0.591–0.984)	> 25–40 > 0.984–1.575	> 40 > 1.575
< 3 x D	6 (87)	4,5 (65)	3 (44)
≥ 3 x D	12 (174)	9 (130)	6 (87)

Wiercenie pakietów

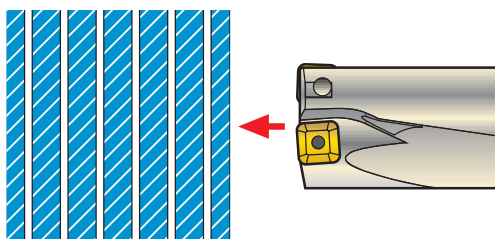

Wiercenie pakietów, bez szczelin powietrznych pomiędzy warstwami, maks. 0,2 mm (0.008") można wykonywać przy użyciu wiertel SD522 2 x D, SD523 3 x D, SD542 2,5 x D oraz SD542 2,5 x D. Detal musi być dobrze zamocowany, aby przy przebijaniu się wiertła przez każdą warstwę nie następowało ugięcie materiału.

Parametry skrawania i zalecenia dot. płytki przy wierceniu pakietów

Geometria płytki:	Geometria płytki	Gatunek węgla
Płytko centralna	SPGX-C1	T400D
Płytko zewn.	SCGX-P2	DP3000

Prędkość skrawania: Patrz zalecenia dla gatunku węgla DP3000

Posuw / obr.: Patrz zalecenia dla geometrii P2

W razie problemów przy przebijaniu się przez poszczególne warstwy materiału zmniejszyć posuw/obrót o 30–50%.

Uwaga!

Krażek powstający gdy wiertło przebija się przez materiał może zostać wyrzucony z dużą prędkością, jeśli wiertło używane jest jako narzędzie nieobrotowe (obraca się detal).

Bardzo ważne jest, aby obrabiarka posiadała odpowiednie osłony gwarantujące bezpieczeństwo operatora.

Ustawianie

Zalecenia odnośnie ustawienia i regulacji średnicy otworu

Wiertła płytkowe można przesunąć względem osi, aby uzyskać otwory o mniejszej lub większej średnicy w stosunku do centrowania.

Zasady postępowania zawarte są w części "Regulacja promieniowa" tabeli narzędzia na odpowiednich stronach katalogu.

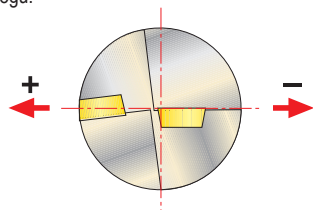

Obrotowe

Przy użyciu wiertel SD522 i SD523, 3 x D jako obrotowych, dla uzyskania otworów precyzyjnych w klasie IT10 zaleca się stosowanie opravek Seco z regulacją.

Stacjonarne

Podczas mocowania wiertła należy zachować równoległość krawędzi skrawających z prowadnicami suportu poprzecznego oraz współosiowość osi wiertła i detalu. W celu uzyskania większej średnicy należy wiertło przemieścić, tak aby zewnętrzna płytka zeszyła z osi obrabianego detalu.

Parametry dla SD602 - Pobór mocy, zapotrzebowanie na chłodziwo i wykresy sił posuwowych

Wartości z wykresów mogą ulegać zmianie, zależnie od parametrów, materiału i sprawności obrabiarki = 80 %.

Poniższe wykresy obowiązują dla grupy materiału P5-P6 i prędkości skrawania 200 m/min (655 sf/min).

Siła od posuwu

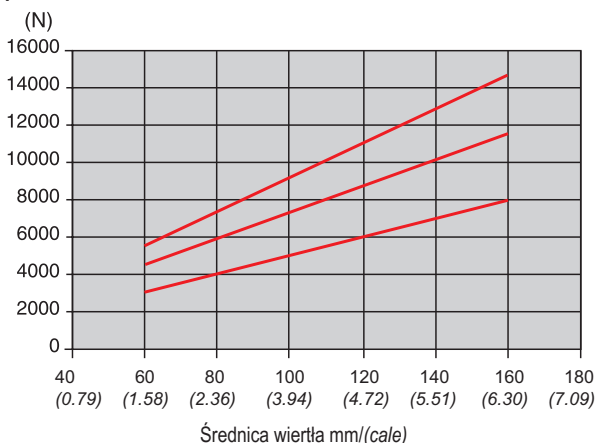

f = 0,18 mm/obr
(f = 0.007 cal/obr)

f = 0,12 mm/obr
(f = 0.005 cal/obr)

f = 0,08 mm/obr
(f = 0.003 cal/obr)

Zapotrzebowanie na moc

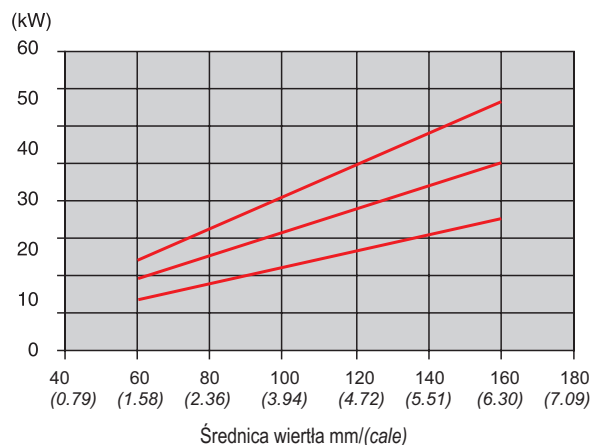

f = 0,18 mm/obr
(f = 0.007 cal/obr)

f = 0,12 mm/obr
(f = 0.005 cal/obr)

f = 0,08 mm/obr
(f = 0.003 cal/obr)

Moment obrotowy

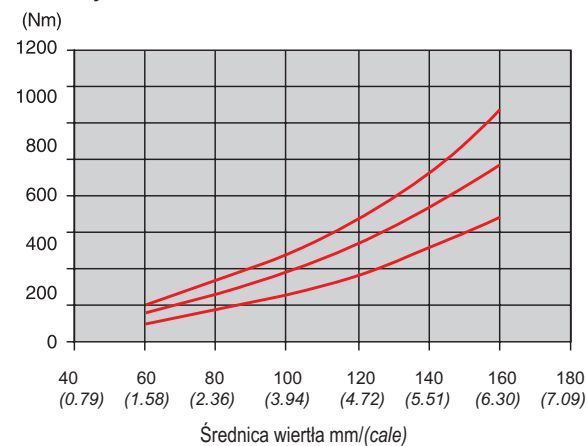

f = 0,18 mm/obr
(f = 0.007 cal/obr)

f = 0,12 mm/obr
(f = 0.005 cal/obr)

f = 0,08 mm/obr
(f = 0.003 cal/obr)

Parametry skrawania SD602

Zapotrzebowanie na chłodziwo

Litry/minutę (galony/minutę)

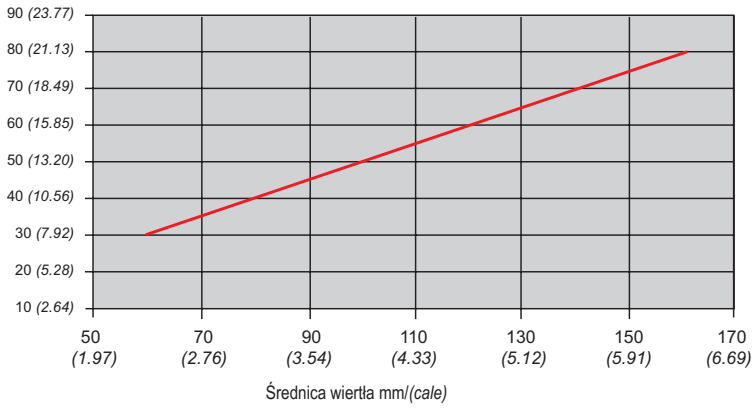

Metoda obróbki

Nie zalecane	Rozwiązanie	
	<p>1.</p>	<p>2.</p>
	<p>1.</p>	<p>2.</p>
	<p>1.</p>	<p>2.</p> <p>> 5xD</p>

Wstęp
Wiercenie
Rozwiercanie
Wyłaczanie
Zalącznik

Wszechstronność

Zastosowania

1. Wiercenie otworów w powierzchni pod kątem
2. Wytaczanie
3. Wiercenie poprzez istniejące otwory
4. Wiercenie i pogłębianie
5. Wiercenie i roztaczanie interpolacją kołową
6. Toczenie wgłębne

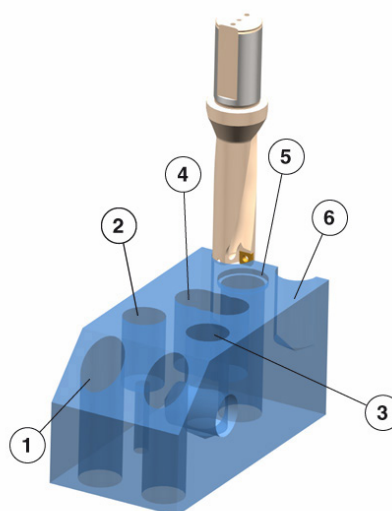

Zastosowanie wiertła jako narzędzia nieobrotowego

1. Wiercenie
2. Wytaczanie / otwory stożkowe
3. Obróbka fazy

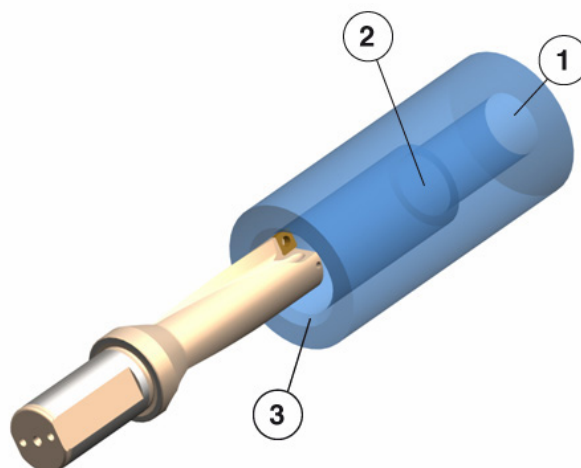

Zalecenia

- Wiertła 2 x D i 3 x D (SD522, SD523)
- Zredukować posuw ~ 50% gdy wiercimy w niepełnym materiale
- Zastosować gatunek DP3000
- Zastosować łamacz -P2

Rozwiązywanie problemów

Drgania

Zastosowania

- Sprawdź zamocowanie wiertła
- Sprawdź zamocowanie detalu
- Zwiększ posuw. Jeśli materiał jest bardzo miękki, zmniejszyć posuw i zwiększyć prędkość
- Zredukować prędkość skrawania

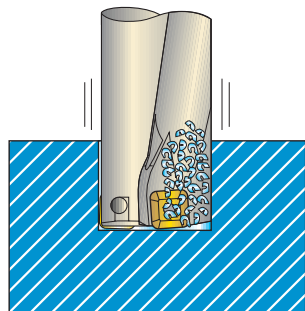

Za duży moment

- Zredukować posuw
- Zastosować geometrię łamacza wiórów na małe posuw

Słaba moc

- Zredukuj prędkość skrawania
- Zredukuj posuw
- Wybierz geometrię lepiej łamiącą wiór przy mniejszych posuwach.

Problem zakleszczania wiórów

Zakleszczania długich wiórów

- Zwiększyć posuw. Jeśli materiał jest bardzo miękki, zredukuj posuw i zwiększ prędkość
- Wybierz geometrię lepiej łamiącą wiór przy mniejszych posuwach (SCGX-P1)

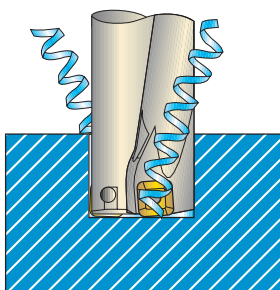

Zakleszczanie krótkiego wióra

- Zwiększyć ciśnienie/wydajność chłodziwa
- Zredukować prędkość skrawania

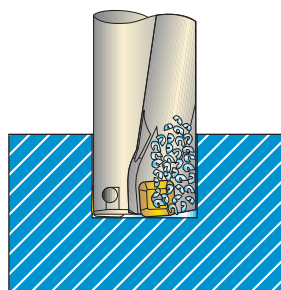

Szybkie zużycie krawędzi przyłożenia na wiertle prowadzącym

- Zredukować prędkość skrawania
- Zwiększyć koncentrację chłodziwa

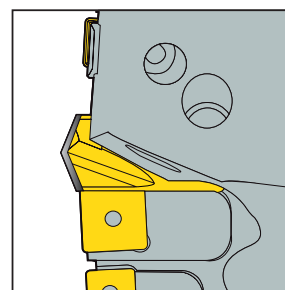

Problemy z trwałością narzędzia

Wykruszenia na płycie zewnętrznej.

- Zredukować posuw na wejściu
- Wybrać bardziej ciągliwy gatunek
- Wybrać geometrię lepiej łamiącą wiór przy większych posuwach (SCGX-P2)
- Zredukować posuw
- Zredukować prędkość skrawania

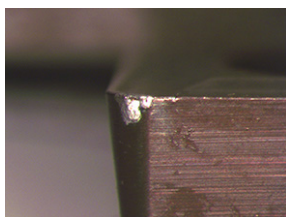

Wykruszenia na płycie centralnej

- Sprawdzić zamocowanie wiertła
- Sprawdzić zamocowanie detalu
- Zredukować posuw na wejściu
- Zwiększyć posuw
- Zredukować prędkość skrawania

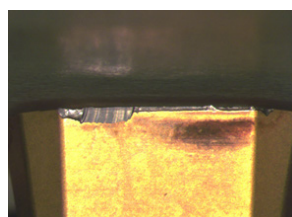

Gwałtowne zużycie powierzchni przyłożenia na płycie zewnętrznej

- Zredukować prędkość skrawania
- Zwiększyć ciśnienie chłodziwa
- Wybrać gatunek bardziej odporny na ścieranie

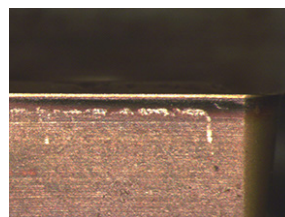

Oprawki nastawne do wiertel

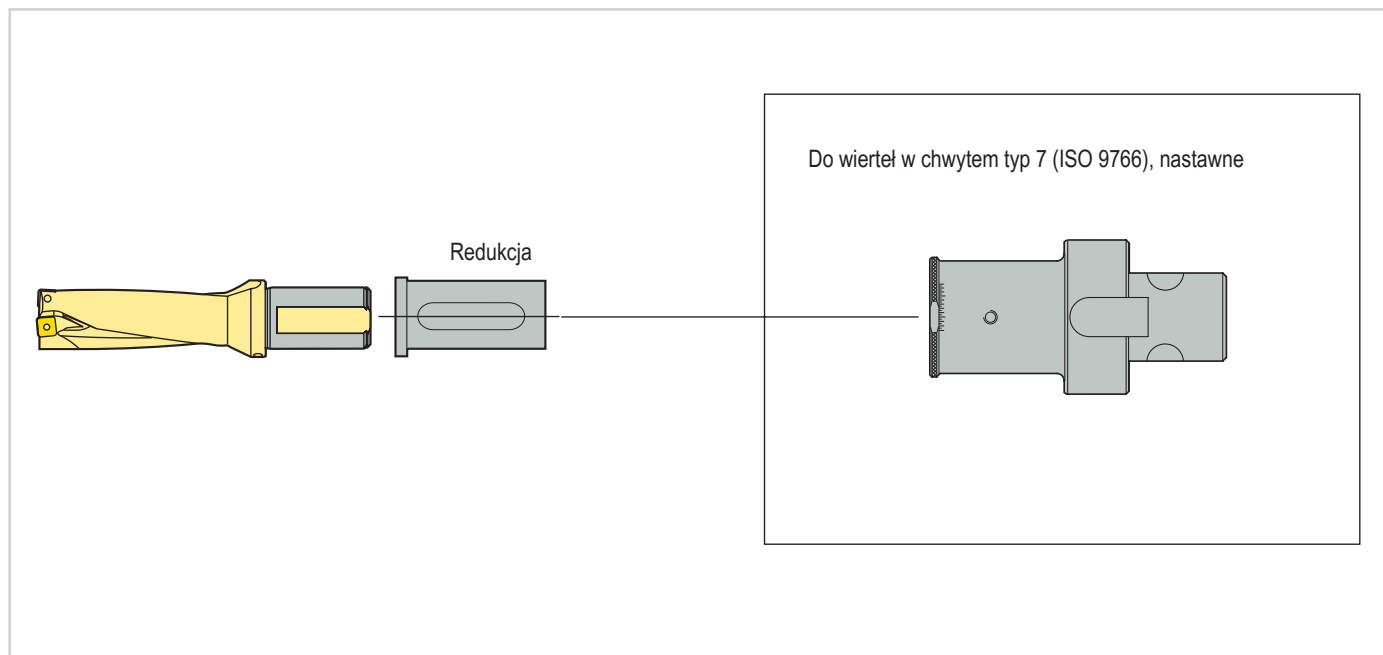

ADH 6101 – Regulowane oprawki wiertarskie, do chwytów typu 7

Graflex®

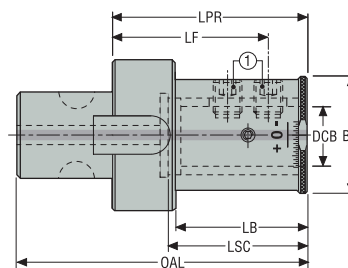

- Do wiertel PerfoMax®
- Zakres regulacji od -0,3 mm do +0,8

1. Śruba mocująca

Numer produktu	Oznaczenie	Od strony obrabiarki Wielkość połączenia Graflex	Od strony detalu Do korpusu wiertła	DCB		OAL		LPR		BD		LF		LB		LSC		Waga kg lbs	Wyważenie
				mm Cal.	mm Cal.	mm Cal.	mm Cal.	mm Cal.	mm Cal.	mm Cal.	mm Cal.	mm Cal.	mm Cal.	mm Cal.	mm Cal.	mm Cal.	mm Cal.		
02422113	BM061610025	G6	R7	25,0 0.984	110,0 4.331	70,0 2.756	49,0 1.929	55,0 2.165	54,0 2.126	54,0 2.126	1,12 2.470	PB							
02422114	BM061610032	G6	R7	32,0 1.260	125,0 4.921	85,0 3.346	71,0 2.795	70,0 2.756	66,0 2.598	60,5 2.382	2,09 4.610	PB							
02422115	BM061610040	G6	R7	40,0 1.575	125,0 4.921	85,0 3.346	81,0 3.189	70,0 2.756	66,0 2.598	60,5 2.382	2,38 5.250	PB							
02422116	BM061610125	G6	R7	25,4 1.000	110,0 4.331	70,0 2.756	49,0 1.929	55,0 2.165	54,0 2.126	54,5 2.146	1,11 2.450	PB							
02422118	BM061610138	G6	R7	38,1 1.500	125,0 4.921	85,0 3.346	81,0 3.189	70,0 2.756	66,0 2.598	60,5 2.382	2,45 5.400	PB							

Części zamienne, zawarte w dostawie

Dla DCB	Śruba mocująca	Zabierak
25/0.984	950AF1210014	90M61
32/1.260	-	90M61
40/1.575	-	90M61
25,4/1.000	950AF1210014	90M61
38,1/1.500	-	90M61

Aksesoria

Dla DCB	Klucz (Typu T)	Klucz
25/0.984	DOUBLE-T	H6B-H6.0L
32/1.260	DOUBLE-T	H6B-H6.0L
40/1.575	DOUBLE-T	H6B-H6.0L
25,4/1.000	DOUBLE-T	H6B-H6.0L
38,1/1.500	-	-

PB=wstępnie wyważone wg projektu (więcej informacji na ten temat można znaleźć na stronie Przewodnik wyważania w katalogu Systemy Narzędziowe)

Wstęp

Wiercenie

Rozwiercanie

Wyłaczanie

Załącznik

Wielostrzowe lub na płytkę – Wybór najlepszego rozwiązania

Jakość, osiągi oraz koszt narzędzia, wszystkie te problemy można rozwiązać. Wybór narzędzia do rozwiercania zależy od tolerancji otworu, jakości produkcji oraz czasu cyklu. Asortyment rozwiertaków Seco może spełnić powyższe wymagania. Stosując Precimaster, Precifix, Bifix, nowy Xfix lub Nanofix rozwiertaki Seco można rozwiązać wszystkie problemy rozwiercania.

Poniższy schemat pomoże ci wybrać najlepsze narzędzie do rozwiercania

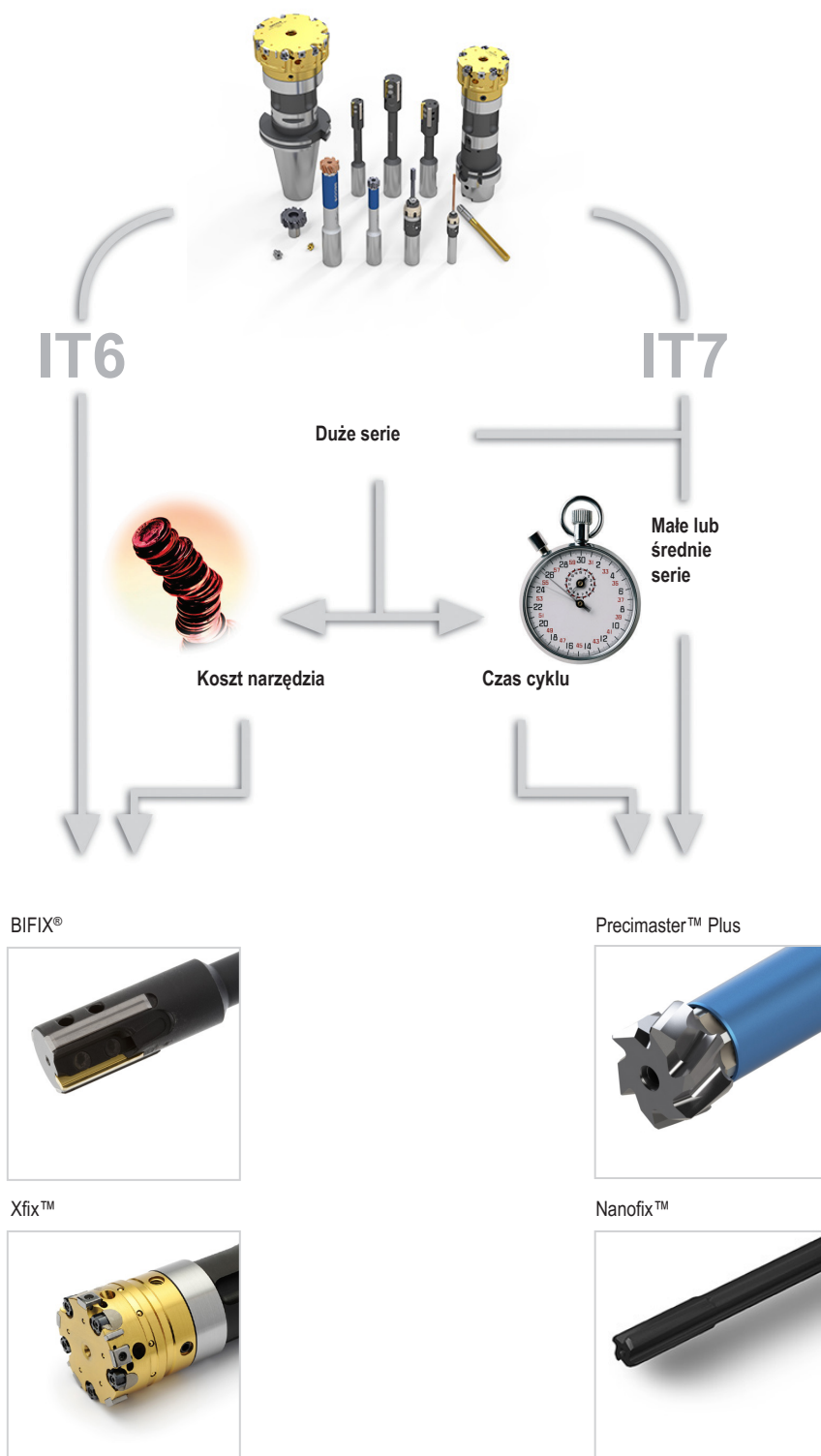

BIFIX®



Xfix™



Precimaster™ Plus

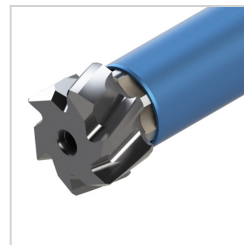

Nanofix™



Przegląd asortymentu

	Zakres \varnothing	Głębokość rozwiercania	Tolerancja \varnothing otworu	Średnice pośrednie	Wykończenie powierzchni
Precimaster™ Plus  Str. - 323-362	7,75-60,500 mm (0.3051-2.3818")	~ 2-10 x D	IT 6-7-8	Tak, dostępne w ramach projektu niestandardowego	R_a 0,2-1,2 μm (R_a 7.87-47.2 μin)
Nanofix™  Str. - 363-397	2,970-12,050 mm (0.1169-0.4744")	~ 5-12 x D	IT 7	Tak, dostępne w ramach projektu niestandardowego	R_a 0,2-1,2 μm (R_a 7.87-47.2 μin)
Bifix®  Str. - 398-424	5,900-60,500 mm (0.2323-2.3819")	~ 2-7 x D	IT 6-7	Tak, dostępne w ramach projektu niestandardowego	R_a 0,2-0,8 μm (R_a 7.87-31.5 μin)
Xfix™  Str. - 425-466	39,500-154,500 mm (1.5551-6.0827")	~ 2,5-6,5 x D	IT 6	Tak, dostępne w ramach projektu niestandardowego	R_a 0,8-1,6 μm (R_a 31-63 μin)



Precimaster™ Plus

Precimaster™ Plus to modułowy system rozwiercania, który zwiększa szybkość, stabilność i wszechstronność, pozwalając precyzyjniej i taniej wykonywać otwory.

- System jest wyposażony w innowacyjne, bardzo precyzyjne połączenie, jednorazowe główce z węgla spiekane oraz wspólne oprawki do otworów przelotowych i nieprzelotowych
- Pozwala uzyskać tolerancje pomiędzy 15 i 25 mikrona, oraz gładkość powierzchni od R_a 0,4 do R_a 0,8 μm (RMS 15 do 35 mikro/cal)

Precimaster™ Plus – Przegląd asortymentu

	Zakres \varnothing	Głębokość rozwiercania	Tolerancja \varnothing otworu	Średnice pośrednie	Wykończenie powierzchni
Wstęp	 <p>PMX5 / PMX6 / PMX8</p> <p>7,75-60 mm (0.3051-2.3622")</p>	~ 2-3 x D	IT 6-7-8	Tak, dostępne w ramach projektu niestandardowego	R_a 0,4-0,8 μ m (R_a 15.7-31.5 μ in)
Wiercenie	 <p>PMX5 / PMX6 / PMX8</p> <p>7,75-60 mm (0.3051-2.3622")</p>	~ 4-5 x D	IT 6-7-8	Tak, dostępne w ramach projektu niestandardowego	R_a 0,4-0,8 μ m (R_a 15.7-31.5 μ in)
Rozwiercanie	 <p>PMX5 / PMX6 / PMX8</p> <p>7,75-60 mm (0.3051-2.3622")</p>	~ 8-10 x D	IT 6-7-8	Tak, dostępne w ramach projektu niestandardowego	R_a 0,4-0,8 μ m (R_a 15.7-31.5 μ in)

Wstęp

Wiercenie

Rozwiercanie

Wytaczanie

Zalącznik

Oznaczenia

Oprawki Precimaster Plus są odpowiednie do otworów przelotowych i nieprzelotowych.

Chwyty narzędzi

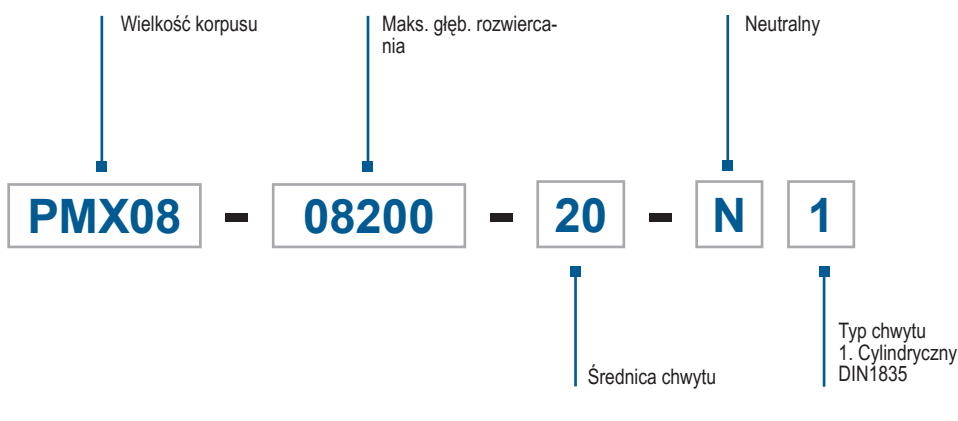

Końcówka

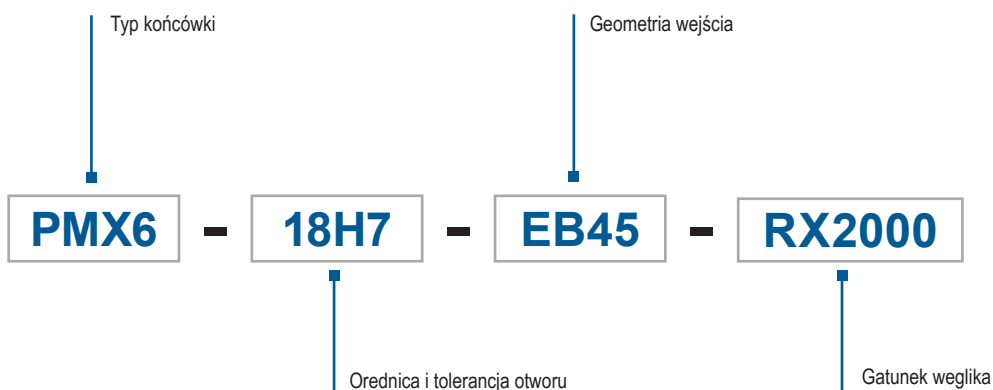

PMX6

Końcówka do średnic pośrednich

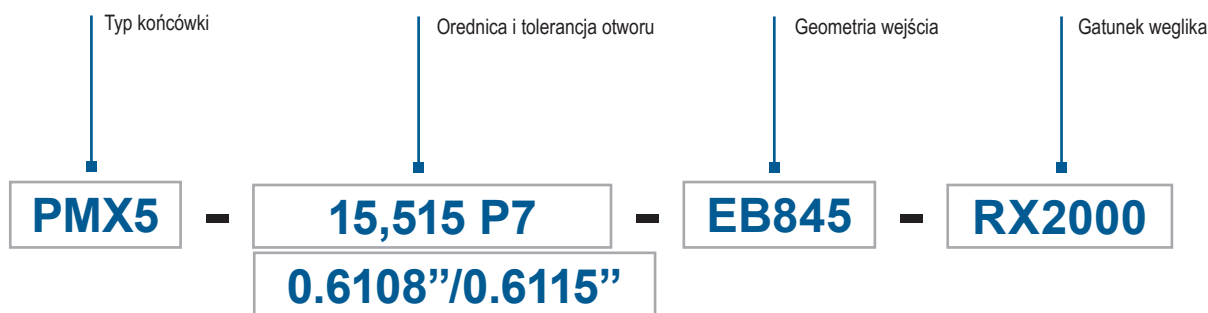

PMX4: Prawa linia śrubowa, odpowiednie do otworów nieprzelotowych tylko.
 PMX5: Proste ostrza, geometria odpowiednia do otworów ślepych i przelotowych.
 PMX6: Lewa linia śrubowa, odpowiednie do otworów przelotowych tylko.
 PMX8: Proste ostrza, geometria odpowiednia do otworów ślepych i przelotowych
 Lewa linia śrubowa, wspomagają wypychanie wiórów w głąb otworu.
 Prawa linia śrubowa poprawia odprowadzanie wiórów do przodu.
 Patrz Precimaster Plus wybór końcówek, str. . 332.

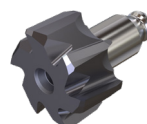

PMX4



PMX5

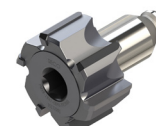

PMX8

Oznaczenia

Oprawki Precimaster Plus są odpowiednie do otworów przelotowych i nieprzelotowych.

Wstęp

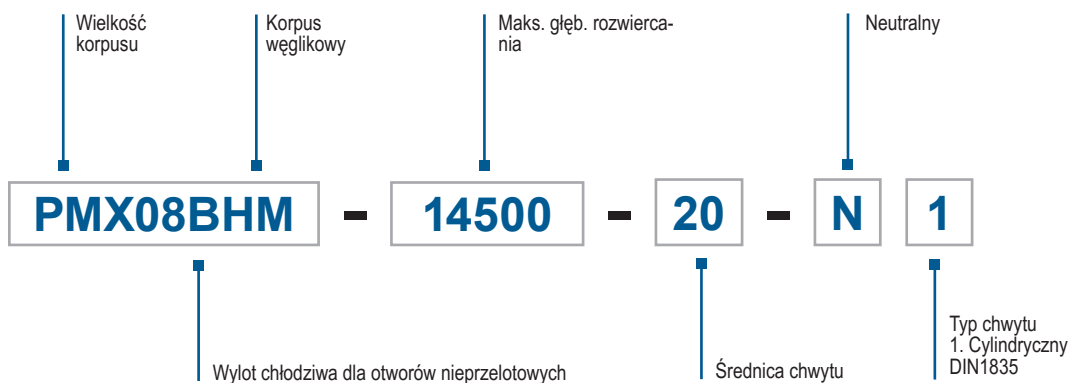

Wiercenie

Rozwiercanie

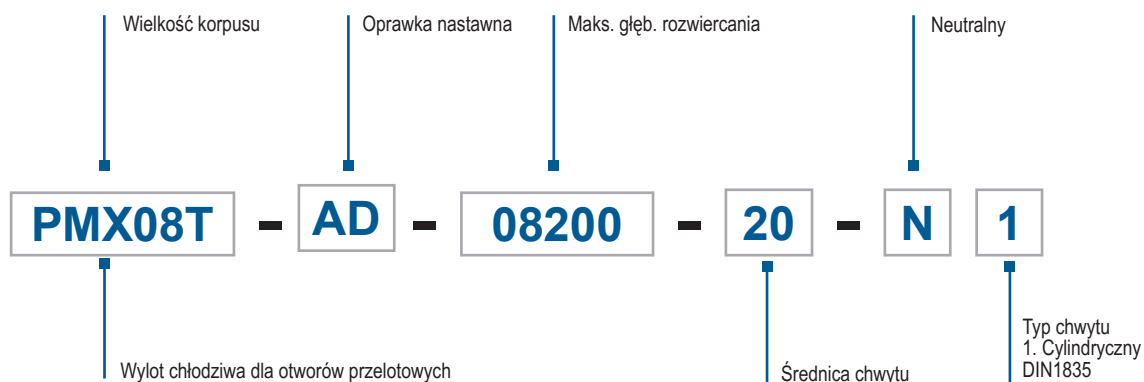

Wyłaczanie

Załącznik

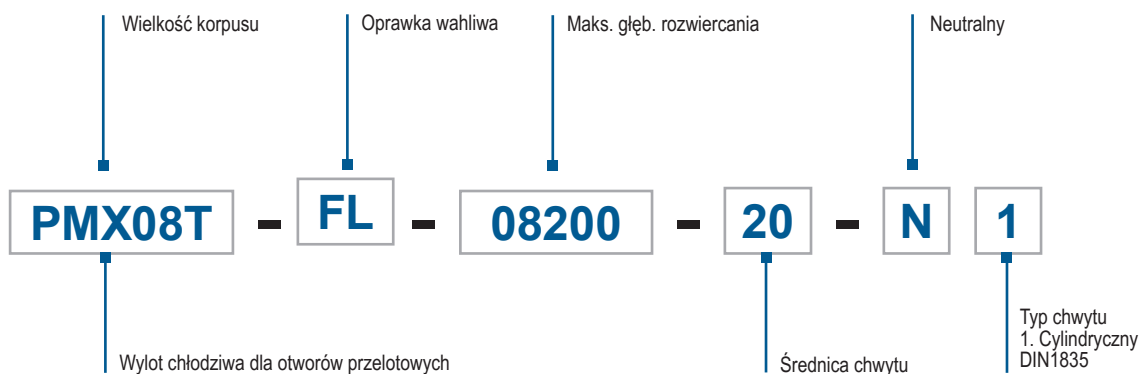

Ustawienie chłodziwa

Procedura ustawienia chłodziwa: Opis części zamiennych

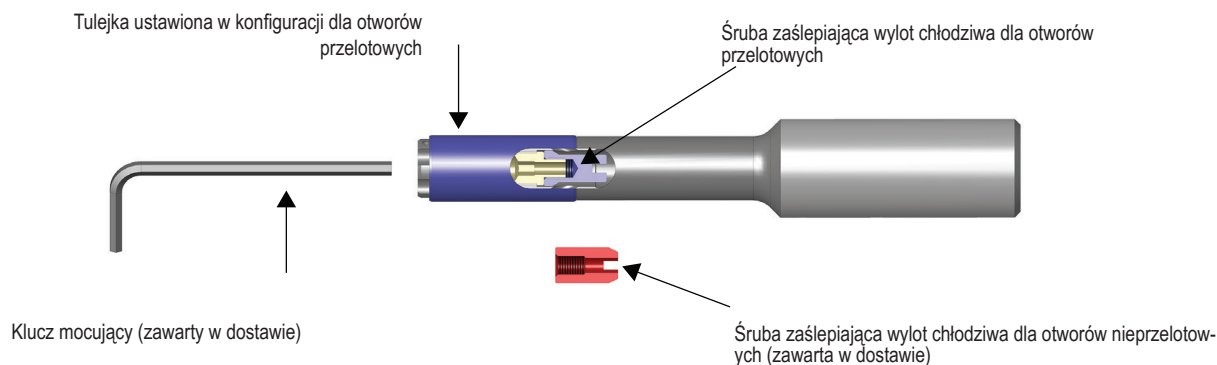

Procedura ustawienia chłodziwa: Ustawienie chłodziwa dla otworów nieprzelotowych

1.

Wykręcić zaślepkę otworu przelotowego (niebieską)
Uwaga: mają lewy gwint

Użyj płaskiego śrubokręta lub klucza,
zalecane narzędzie ręczne zgodnie z tabelą

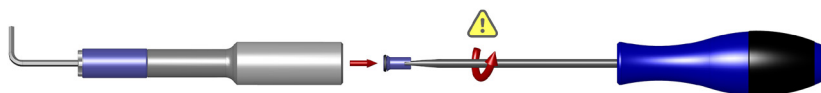

Wielkość oprawki	Wielkość śrubokręta płaskiego mm	Wielkość śrubokręta płaskiego cale	Klucz sześciok. wielkość mm	Klucz sześciok. wielkość cale
PMX05	1,2 x 4 x 120	0.05 x 0.16 x 4.72	2 x 120	0.08 x 4.72
PMX06	1,0 x 5,5 x 150	0.04 x 0.22 x 5.9	2,5 x 150	0.10 x 5.9
PMX08	1,2 x 6,5 x 200	0.05 x 0.26 x 7.87	3 x 200	0.12 x 7.87
PMX12	1,2 x 8 x 200	0.05 x 0.31 x 6.89	5 x 200	0.2 x 6.89

2.

Usuń tulejkę

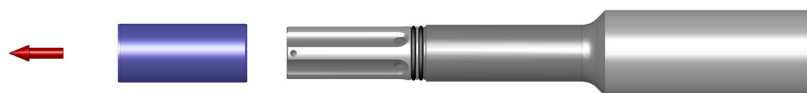

3.

Wkręcić zaślepkę otworu nieprzelotowego (czerwoną)
Uwaga: mają lewy gwint



Mocowanie końcówki

Wstęp

Wiercenie

Rozwiercanie

Wyłaczanie

Załącznik

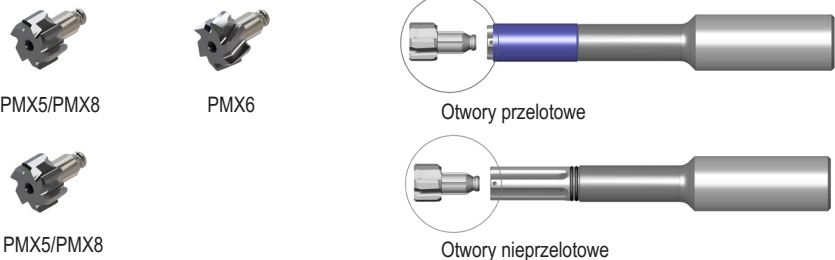
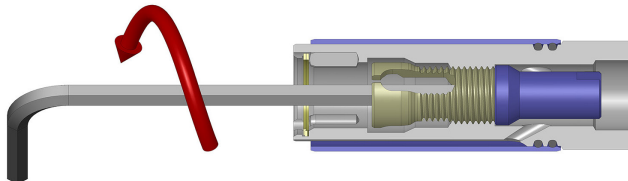
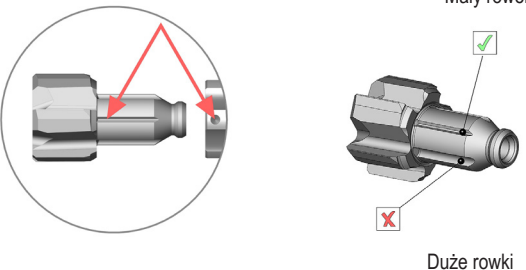
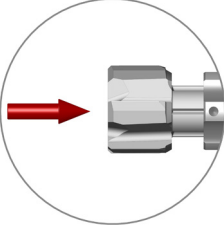
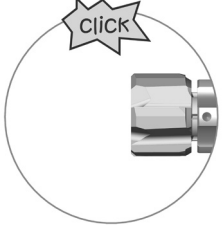
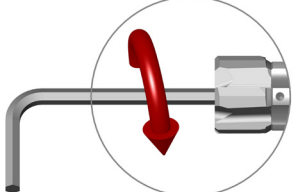
<p>1. Upewnij się iż geometria jest odpowiednia do wybranego ustawienia chłodziwa</p>	 <p>PMX5/PMX8 PMX6</p> <p>PMX5/PMX8</p> <p>Otwory przelotowe</p> <p>Otwory nieprzelotowe</p>												
<p>2. Ustawić w pozycji mocowanie</p>													
<p>3. Wskaźnik ustawić na czerwonej kropce na korpusie</p>	 <p>Mały rowek</p> <p>Duże rowki</p>												
<p>4. Założyć końcówkę do korpusu</p>													
<p>5. Docisnąć końcówkę w korpusie do uzyskania „kliknięcia”</p>	 <p>click</p>												
<p>6. Zamocować końcówkę za pomocą klucza</p>	 <table border="1" data-bbox="1029 1780 1412 1960"> <thead> <tr> <th>PMX Wielkość oprawki</th> <th>Zalecany moment mocowania</th> </tr> </thead> <tbody> <tr> <td>PMX05</td> <td>0,5 Nm</td> </tr> <tr> <td>PMX06</td> <td>0,9 Nm</td> </tr> <tr> <td>PMX08</td> <td>1,2 Nm</td> </tr> <tr> <td>PMX12</td> <td>2,0 Nm</td> </tr> <tr> <td>PMX16</td> <td>5,0 Nm</td> </tr> </tbody> </table>	PMX Wielkość oprawki	Zalecany moment mocowania	PMX05	0,5 Nm	PMX06	0,9 Nm	PMX08	1,2 Nm	PMX12	2,0 Nm	PMX16	5,0 Nm
PMX Wielkość oprawki	Zalecany moment mocowania												
PMX05	0,5 Nm												
PMX06	0,9 Nm												
PMX08	1,2 Nm												
PMX12	2,0 Nm												
PMX16	5,0 Nm												

Ustawienie - Bicie

Narzędzie obrotowe

Maksymalne zalecane bicie: 10-15 μm (393.7008-590.5512 μin).
Zaleca się oprawki hydrauliczne, Shrinkfit lub na tulejki precyzyjne.
Dla lepszej regulacji bicia zalecamy użycie regulowanego adaptera
Precimaster Plus PMX-AD, patrz str. 345-346.

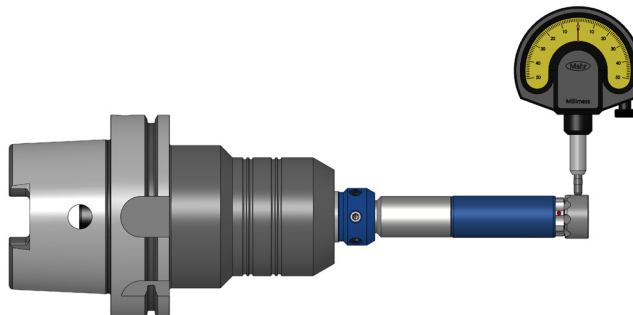

Narzędzie nieobrotowe

Stosuj oprawki wahlwe Precimaster Plus PMX - FL, patrz str. 347-348.

Oprawka wahlwiwa umożliwia wycentrowanie się rozwiertaka w otworze.

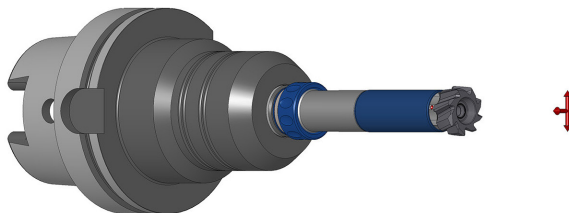

Wymagania odnośnie chłodzenia

Celem uzyskania maksymalnej trwałości ostrza oraz jakości otworu należy spełnić poniższe wymagania.

Zalecane jest chłodzenie przez narzędzie.

Zewnętrzne chłodzenie można stosować gdy głębokość rozwiercania $< 2 \times D$.

Dobrej jakości olej rozpuszczalny z dodatkiem min. 40 % oleju mineralnego.

Do stali nierdzewnej zaleca się olej bez domieszek.

Koncentracja min 6-8 %

Filtracja 30-50 μm (1200-2000 μcal).

Wydatek 0,5 l/min/mm (3.35 gal/min/cal) w średnicy narzędzia.

(Np.: Rozwiertak $\varnothing 10$, min. wydatek to 5 l/min (1.3 gal/min)).

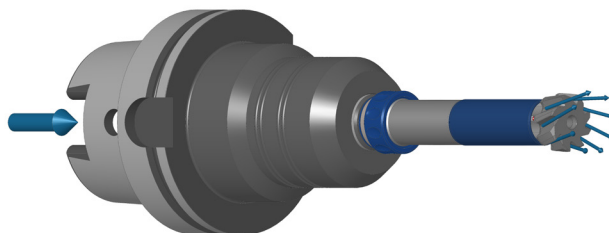

Pomiar średnicy

Mikrometryczny czujnik zegarowy przed pomiarem średnicy.



Ważne

Rozwiertak Precimaster posiada zmienną podziałkę zębów.
Podczas pomiaru upewnij się, że mierzysz 2 ostrza zorientowane względem siebie o 180°

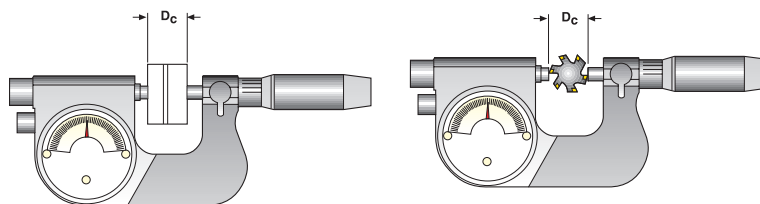
Do pomiaru należy użyć czujnika mikrometrycznego oraz podstawki.

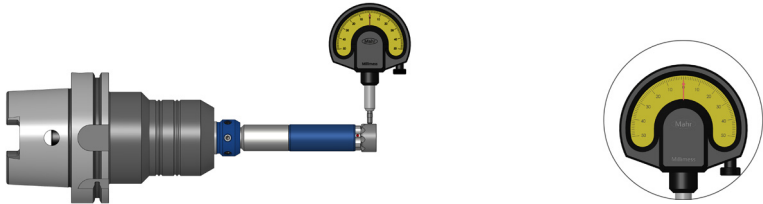
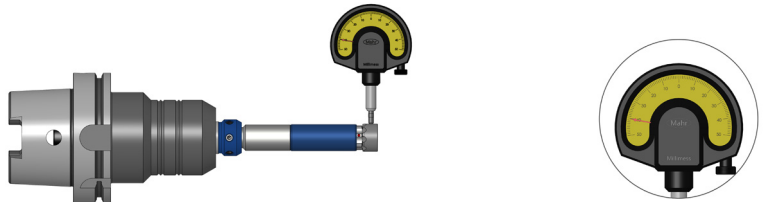
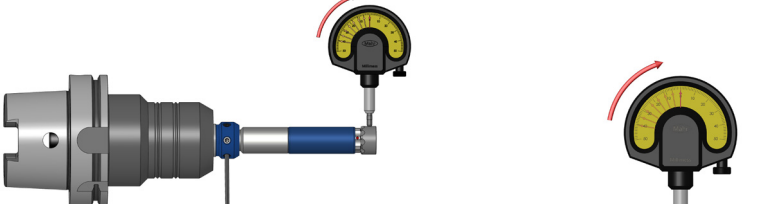

Ustawianie chwytów regulacyjnych:

<p>1. Zamontować końcówkę do ustawiania (dostarczaną z oprawką nastawną). Zamocować narzędzie we wrzecionie.</p> <p>2. Ustawić zegar w sposób przedstawiony na rysunku.</p>	
<p>3. Obracaj narzędzie ręką do uzyskania najniższego punktu</p>	
<p>4. Wykonaj regulację kompensacji bicia za pomocą śruby. Kierunek wskazany strzałkami.</p> <p>5. Sprawdzić bicie i w razie potrzeby powtórzyć kompensację.</p>	
<p>6. W przypadku gdy maks. bicie jest mniejsze niż 5 μm (197 μca), zablokuj śrubę regulacyjną aby nie utracić ustawiń</p>	



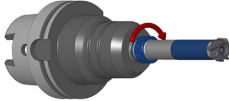
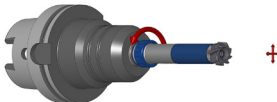
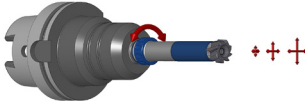

Konfiguracja chwytów wahliwych:

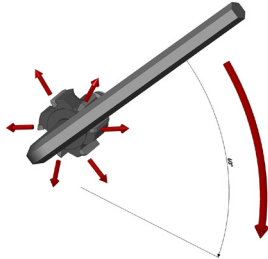
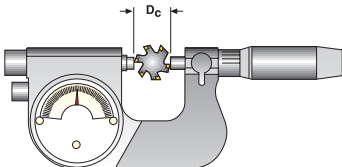
<p>1. Zablokuj oprawkę obracając pierścień regulacyjny zgodnie z obrotem zegara</p>	
<p>2. Odblokuj oprawkę przez 2 lub 3 kliknięcia obracając pierścień przeciwnie do ruchu zegara</p>	
<p>3. W razie potrzeby przejść do dalszej regulacji wartości położenia swobodnego. Zbyt wysoka wartość położenia swobodnego może spowodować niestabilne warunki na wejściu w otwór. Zbyt mała wartość zakresu może powodować drgania oraz stożkowy otwór.</p>	

Możliwość rozszerzenia kompensacji zużycia rozwiertaka

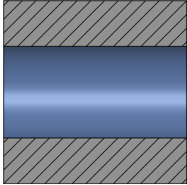
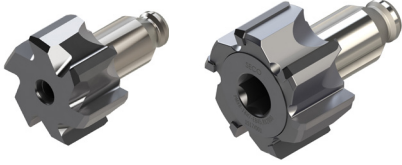
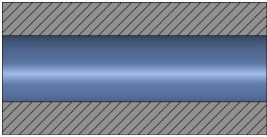
<p>1. Do kompensacji średnicy \varnothing należy użyć klucza sześciokątnego (obrót 60° = około $0.005 \mu\text{m}$ ($0.197 \mu\text{cala}$) korekty na \varnothing)</p>	
<p>2. Sprawdź czujnikiem średnicę \varnothing po dokonaniu korekty</p>	

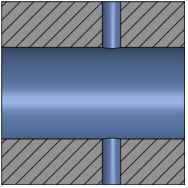
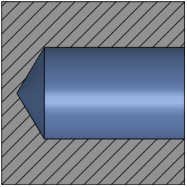
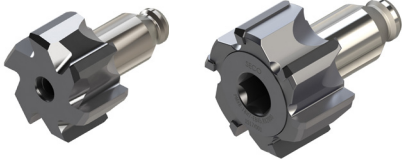
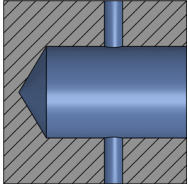
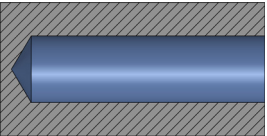
Wybór końcówki

Obrabiany detal	Zakres średnic \varnothing 8–60 mm (0.3150–2.3622")	
<p>Krótki otwór przelotowy < 3 x D</p> 	<p>PMX5 / PMX8</p> 	
<p>Długi otwór przelotowy > 3 x D</p> 	<p>PMX6 Do otworów przelotowych, wylot chłodziwa w oprawce powinien być ustawiony dla otworów przelotowych: patrz instrukcje</p> 	
<p>Otwór przecinający inny</p> 		
<p>Otwór nieprzelotowy</p> 	<p>PMX5 / PMX8 Do otworów nieprzelotowych, wylot chłodziwa w oprawce powinien być ustawiony dla otworów nieprzelotowych: patrz instrukcje</p> 	
<p>Otwór nieprzelotowy przecinający inny</p> 		
<p>Otwór nieprzelotowy > 3x D.</p> 	<p>PMX4 Do otworów nieprzelotowych, wylot chłodziwa w oprawce powinien być ustawiony dla otworów nieprzelotowych: patrz instrukcje</p> 	

Wstęp

Wiercenie

Rozwiercanie

Wyłaczanie

Załącznik

Wybór geometrii - Zastosowania

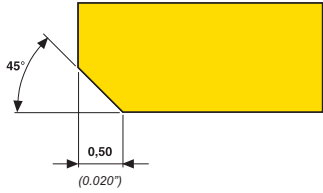
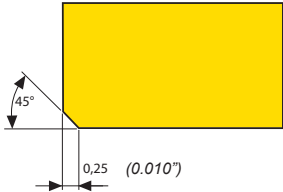
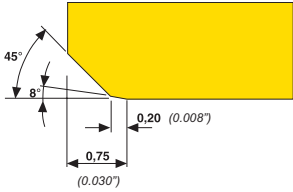
Geometria wejścia - EB45	
<p>Kontrola wióra ++ Gładkość powierzchni +++ R_a 0,8–1,2 μm (Gładkość powierzchni +++ R_a 31 – 47 μcal) Uniwersalność</p>	
Geometria wejścia - EBS45	
<p>Kontrola wióra +++ Gładkość powierzchni + R_a 0,8–1,2 (Gładkość powierzchni + R_a 31 – 47 μcal) Krótki EB45</p>	
Geometria wejścia - EB845	
<p>Kontrola wióra ++ Gładkość powierzchni +++ R_a 0,2–0,8 μm (Gładkość powierzchni +++ R_a 8–31 μcal)</p>	

Wstęp

Wiercenie

Rozwieranie

Wytaczanie

Załącznik

Wybór geometrii - Zastosowania

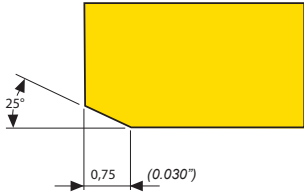
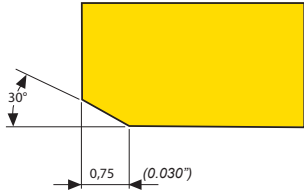
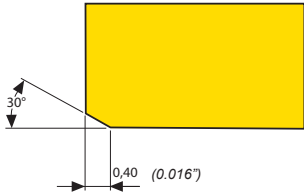
Geometria wejścia - EB25	
<p>Wydajność posuwu +++ Gładkość powierzchni ++ R_a 0,4–0,8 μm (Gładkość powierzchni ++ R_a 16–31 μcala) Kontrola wióra +</p>	
Geometria wejścia - EB30	
<p>Wydajność posuwu +++ Gładkość powierzchni ++ R_a 0,4–0,8 μm (Gładkość powierzchni ++ R_a 16–31 μcala) Kontrola wióra +</p>	
Geometria wejścia - EBS30	
<p>Wydajność posuwu +++ Gładkość powierzchni ++ R_a 0,4–0,8 μm (Gładkość powierzchni ++ R_a 16–31 μcala) Kontrola wióra + Krótki EB30</p>	

Wybór geometrii - Zastosowania

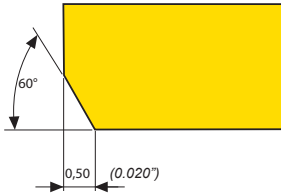
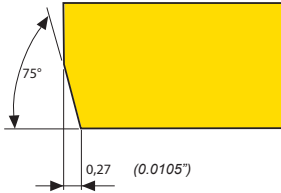
Geometria wejścia - EB60	
<p>Wydajność posuwu + Gładkość powierzchni ++ R_a 0,8–1,2 μm (Gładkość powierzchni ++ R_a 31–47 μcala) Kontrola wióra ++</p>	
Geometria wejścia - EB75	
<p>Wydajność posuwu + Gładkość powierzchni ++ R_a 0,8–1,2 μm (Gładkość powierzchni ++ R_a 31–47 μcala) Kontrola wióra ++</p>	

Wstęp

Wiercenie

Rozwiercanie

Wytaczanie

Załącznik

Wybór geometrii - Zastosowania

Geometria wejścia - RE040	
<p>Wydajność posuwu ++ Gładkość powierzchni ++ R_a 0,4–0,8 μm (Gładkość powierzchni ++ R_a 16–31 μcala) Kontrola wióra +</p>	
Geometria wejścia - RE080	
<p>Wydajność posuwu ++ Gładkość powierzchni ++ R_a 0,4–0,8 μm (Gładkość powierzchni ++ R_a 16–31 μcala) Kontrola wióra +</p>	
Geometria wejścia - RE120	
<p>Wydajność posuwu ++ Gładkość powierzchni ++ R_a 0,4–0,8 μm (Gładkość powierzchni ++ R_a 16–31 μcala) Kontrola wióra + Dostępne od \varnothing 14 mm (0.551")</p>	

Wstęp

Wiercenie

Rozwiercanie

Wyłaczanie

Załącznik

Gatunki		
	RX2000	Pokrywany Węgiel o wysokiej wydajności odpowiedni do wszystkich materiałów..
	CP20	Pokrywany Uniwersalny gatunek odpowiedni dla większości materiałów, z wyjątkiem aluminium. TiN
	H15	Pokrywany Ciągły węgiel mikro-ziarnisty do wszystkich materiałów. Odpowiedni do operacji dokładnego rozwiercania dzięki bardzo dużej ostrości krawędzi.
	CF	Cermet Gatunek odporny na ocieranie do optymalizacji wydajności obróbki stali.
	RX1500	Pokrywany Cermet Gatunek odporny na ścieranie do optymalizacji wydajności obróbki stali i żeliwa.
	RN2010	Niepokrywany Gatunek mikroziarnisty o zoptymalizowanej geometrii dla materiałów N (nieżelaznych).
	RM2020	Pokrywany Gatunek ciągły, odpowiedni do obróbki precyzyjnej z zoptymalizowaną geometrią dla materiałów M.
	RM2090	Pokrywany Gatunek odpornym na ścieranie, o określonych geometriach dla materiałów typu M. Optymalizacja dla materiałów typu M.
	RK2050	Pokrywany Gatunek ciągły, odpowiedni do rozwiercania z zoptymalizowaną geometrią dla materiałów K.
	RK1550	Pokrywany Cermet Gatunek odpornym na ścieranie, o określonych geometriach dla materiałów typu K. Optymalizacja dla materiałów typu K.
	RS2090	Pokrywany Gatunek odpornym na ścieranie, o określonych geometriach dla materiałów typu S. Optymalizacja dla materiałów typu S.

Końcówki do otworów przelotowych i nieprzelotowych

∅ 8-32 mm / 0.315-1.260"

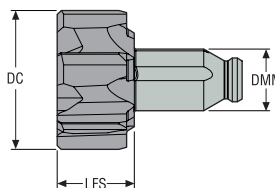

- Wybór geometrii, patrz str. 333-336
- Parametry skrawania, patrz strona (strony) 355-362

Oznaczenie	Numer produktu	DC	Średnica wiertła*	LFS	DMM	Wielkość korpusu	Geometrie			Gatunki					
							EB45	EB845		H15	CP20	RX2000	CF	RX1500	
		mm	mm		mm	mm									
PMX5-8H7-EB45	03123158	8,0	7,8/7,9	6	6,0	4,5	PMX05-xx	■	□	□	□	□	■	-	-
PMX5-9H7-EB45	03123159	9,0	8,8/8,9	6	6,0	4,5	PMX05-xx	■	□	□	□	□	■	-	-
PMX5-10H7-EB30	10020602	10,0	9,8/9,9	6	7,0	6,0	PMX06-xx	□	□	■	□	□	■	□	□
PMX6-10H7-EB45	02965863	10,0	9,8/9,9	6	7,0	6,0	PMX06-xx	■	□	□	□	□	■	□	□
PMX5-11H7-EB45	02925754	11,0	10,8/10,9	6	7,0	6,0	PMX06-xx	■	□	□	□	□	■	□	□
PMX5-12H7-EB30	10019482	12,0	11,8/11,908	6	7,0	6,0	PMX06-xx	□	□	■	□	□	■	□	□
PMX5-12H7-EB45	02925755	12,0	11,8/11,908	6	7,0	6,0	PMX06-xx	■	□	□	□	□	■	□	□
PMX5-13H7-EB30	10019483	13,0	12,8/12,9	6	7,0	6,0	PMX06-xx	□	□	■	□	□	■	□	□
PMX5-13H7-EB45	02925756	13,0	12,8/12,9	6	7,0	6,0	PMX06-xx	■	□	□	□	□	■	□	□
PMX5-14H7-EB30	10019484	14,0	13,8/13,891	6	7,0	6,0	PMX06-xx	□	□	■	□	□	■	□	□
PMX5-14H7-EB45	02925757	14,0	13,8/13,891	6	7,0	6,0	PMX06-xx	■	□	□	□	□	■	□	□
PMX5-15H7-EB30	10019485	15,0	14,8/14,9	6	10,0	8,0	PMX08-xx	□	□	■	□	□	■	□	□
PMX5-15H7-EB45	02925758	15,0	14,8/14,9	6	10,0	8,0	PMX08-xx	■	□	□	□	□	■	□	□
PMX5-16H7-EB30	10019486	16,0	15,8/15,9	6	10,0	8,0	PMX08-xx	□	□	■	□	□	■	□	□
PMX5-16H7-EB45	02925759	16,0	15,8/15,9	6	10,0	8,0	PMX08-xx	■	□	□	□	□	■	□	□
PMX5-17H7-EB30	10019487	17,0	16,8/16,9	6	10,0	8,0	PMX08-xx	□	□	■	□	□	■	□	□
PMX5-17H7-EB45	02925760	17,0	16,8/16,9	6	10,0	8,0	PMX08-xx	■	□	□	□	□	■	□	□
PMX5-18H7-EB30	10019488	18,0	17,8/17,9	6	10,0	8,0	PMX08-xx	□	□	■	□	□	■	□	□
PMX5-18H7-EB45	02925761	18,0	17,8/17,9	6	10,0	8,0	PMX08-xx	■	□	□	□	□	■	□	□
PMX5-19H7-EB30	10019489	19,0	18,8/18,9	6	10,0	8,0	PMX08-xx	□	□	■	□	□	■	□	□
PMX5-19H7-EB45	02925762	19,0	18,8/18,9	6	10,0	8,0	PMX08-xx	■	□	□	□	□	■	□	□
PMX5-20H7-EB30	10020603	20,0	19,8/19,9	6	10,0	8,0	PMX08-xx	□	□	■	□	□	■	□	□
PMX5-20H7-EB45	02925763	20,0	19,8/19,9	6	10,0	8,0	PMX08-xx	■	□	□	□	□	■	□	□
PMX5-21H7-EB45	02925764	21,0	20,8/20,9	6	10,0	8,0	PMX08-xx	■	□	□	□	□	■	□	□
PMX5-22H7-EB30	10020604	22,0	21,8/21,9	8	12,0	12,0	PMX12-xx	□	□	■	□	□	■	□	□
PMX5-22H7-EB45	02925765	22,0	21,8/21,9	8	12,0	12,0	PMX12-xx	■	□	□	□	□	■	□	□
PMX5-23H7-EB30	10019490	23,0	22,8/22,9	8	12,0	12,0	PMX12-xx	□	□	■	□	□	■	□	□
PMX5-23H7-EB45	02925766	23,0	22,8/22,9	8	12,0	12,0	PMX12-xx	■	□	□	□	□	■	□	□
PMX5-24H7-EB30	10019491	24,0	23,813/23,9	8	12,0	12,0	PMX12-xx	□	□	■	□	□	■	□	□
PMX5-24H7-EB45	02925767	24,0	23,813/23,9	8	12,0	12,0	PMX12-xx	■	□	□	□	□	■	□	□
PMX5-25H7-EB30	10019492	25,0	24,8/24,9	8	12,0	12,0	PMX12-xx	□	□	■	□	□	■	□	□
PMX5-25H7-EB45	02925768	25,0	24,8/24,9	8	12,0	12,0	PMX12-xx	■	□	□	□	□	■	□	□
PMX5-26H7-EB30	10019493	26,0	25,8/25,9	8	12,0	12,0	PMX12-xx	□	□	■	□	□	■	□	□
PMX5-26H7-EB45	02925769	26,0	25,8/25,9	8	12,0	12,0	PMX12-xx	■	□	□	□	□	■	□	□
PMX5-27H7-EB45	02925770	27,0	26,8/26,9	8	12,0	12,0	PMX12-xx	■	□	□	□	□	■	□	□
PMX5-28H7-EB30	10019494	28,0	26,8/26,9	8	12,0	12,0	PMX12-xx	□	□	■	□	□	■	□	□

Wstęp

Wfoczenie

Rozwiercanie

Wytaczanie

Załącznik

Oznaczenie	Numer produktu	DC	Średnica wiertła*		LFS	DMM	Wielkość korpusu	Geometrie			Gatunki				
			mm	mm 				EB45	EB845		H15	CP20	RX2000	CF	RX1500
PMX5-28H7-EB45	02925771	28,0	27,8/27,9	8	12,0	12,0	PMX12-xx	<input checked="" type="checkbox"/>	<input type="checkbox"/>	<input type="checkbox"/>	<input type="checkbox"/>	<input type="checkbox"/>	<input checked="" type="checkbox"/>	<input type="checkbox"/>	<input type="checkbox"/>
PMX5-29H7-EB45	02925772	29,0	28,8/28,9	8	12,0	12,0	PMX12-xx	<input checked="" type="checkbox"/>	<input type="checkbox"/>	<input type="checkbox"/>	<input type="checkbox"/>	<input type="checkbox"/>	<input checked="" type="checkbox"/>	<input type="checkbox"/>	<input type="checkbox"/>
PMX5-30H7-EB30	10019495	30,0	29,8/29,9	8	12,0	12,0	PMX12-xx	<input type="checkbox"/>	<input type="checkbox"/>	<input checked="" type="checkbox"/>	<input type="checkbox"/>	<input type="checkbox"/>	<input checked="" type="checkbox"/>	<input type="checkbox"/>	<input type="checkbox"/>
PMX5-30H7-EB45	02925773	30,0	29,8/29,9	8	12,0	12,0	PMX12-xx	<input checked="" type="checkbox"/>	<input type="checkbox"/>	<input type="checkbox"/>	<input type="checkbox"/>	<input type="checkbox"/>	<input checked="" type="checkbox"/>	<input type="checkbox"/>	<input type="checkbox"/>
PMX5-32H7-EB30	10019496	32,0	31,8/31,9	8	12,0	12,0	PMX12-xx	<input type="checkbox"/>	<input type="checkbox"/>	<input checked="" type="checkbox"/>	<input type="checkbox"/>	<input type="checkbox"/>	<input checked="" type="checkbox"/>	<input type="checkbox"/>	<input type="checkbox"/>
PMX5-32H7-EB45	02925775	32,0	31,8/31,9	8	12,0	12,0	PMX12-xx	<input checked="" type="checkbox"/>	<input type="checkbox"/>	<input type="checkbox"/>	<input type="checkbox"/>	<input type="checkbox"/>	<input checked="" type="checkbox"/>	<input type="checkbox"/>	<input type="checkbox"/>

= Pozycja niestandardowa.

Uwaga: Przy zamawianiu rozwiertaka Nanofix dla średnic pośrednich należy podać średnicę i tolerancję rozwiercanego otworu.

Przykładowe zamówienie: PMX5-16.515 P7-EB45 RM2020. PMX6-16.515 P7-EB45 RM2020.

Końcówki do otworów przelotowych

Ø 8-32 mm / 0.315-1.260"

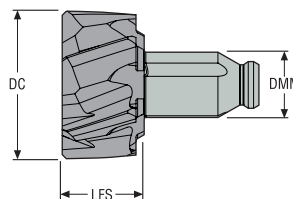

- Wybór geometrii, patrz str. 333-336
- Parametry skrawania, patrz strona (strony) 355-362

Oznaczenie	Numer produktu	DC	Średnica wiertła*	LFS	DMM	Wielkość korpusu	Geometrie			Gatunki					
							EB45	EB845		H15	CP20	RX2000	CF	RX1500	
PMX6-8H7-EB45	03123161	8,0	7,8/7,9	6	6,0	4,5	PMX05-xx	<input checked="" type="checkbox"/>	<input type="checkbox"/>	<input type="checkbox"/>	<input type="checkbox"/>	<input type="checkbox"/>	<input checked="" type="checkbox"/>	-	-
PMX6-9H7-EB45	03123162	9,0	8,8/8,9	6	6,0	4,5	PMX05-xx	<input checked="" type="checkbox"/>	<input type="checkbox"/>	<input type="checkbox"/>	<input type="checkbox"/>	<input type="checkbox"/>	<input checked="" type="checkbox"/>	-	-
PMX6-10H7-EB45	02965863	10,0	9,8/9,9	6	7,0	6,0	PMX06-xx	<input checked="" type="checkbox"/>	<input type="checkbox"/>	<input type="checkbox"/>	<input type="checkbox"/>	<input type="checkbox"/>	<input checked="" type="checkbox"/>	<input type="checkbox"/>	<input type="checkbox"/>
PMX6-11H7-EB45	02925776	11,0	10,8/10,9	6	7,0	6,0	PMX06-xx	<input checked="" type="checkbox"/>	<input type="checkbox"/>	<input type="checkbox"/>	<input type="checkbox"/>	<input type="checkbox"/>	<input checked="" type="checkbox"/>	<input type="checkbox"/>	<input type="checkbox"/>
PMX6-12H7-EB45	02925777	12,0	11,8/11,908	6	7,0	6,0	PMX06-xx	<input checked="" type="checkbox"/>	<input type="checkbox"/>	<input type="checkbox"/>	<input type="checkbox"/>	<input type="checkbox"/>	<input checked="" type="checkbox"/>	<input type="checkbox"/>	<input type="checkbox"/>
PMX6-13H7-EB45	02925778	13,0	12,8/12,9	6	7,0	6,0	PMX06-xx	<input checked="" type="checkbox"/>	<input type="checkbox"/>	<input type="checkbox"/>	<input type="checkbox"/>	<input type="checkbox"/>	<input checked="" type="checkbox"/>	<input type="checkbox"/>	<input type="checkbox"/>
PMX6-14H7-EB45	02925779	14,0	13,8/13,891	6	7,0	6,0	PMX06-xx	<input checked="" type="checkbox"/>	<input type="checkbox"/>	<input type="checkbox"/>	<input type="checkbox"/>	<input type="checkbox"/>	<input checked="" type="checkbox"/>	<input type="checkbox"/>	<input type="checkbox"/>
PMX6-15H7-EB45	02925780	15,0	14,8/14,9	6	10,0	8,0	PMX08-xx	<input checked="" type="checkbox"/>	<input type="checkbox"/>	<input type="checkbox"/>	<input type="checkbox"/>	<input type="checkbox"/>	<input checked="" type="checkbox"/>	<input type="checkbox"/>	<input type="checkbox"/>
PMX6-16H7-EB45	02925781	16,0	15,8/15,9	6	10,0	8,0	PMX08-xx	<input checked="" type="checkbox"/>	<input type="checkbox"/>	<input type="checkbox"/>	<input type="checkbox"/>	<input type="checkbox"/>	<input checked="" type="checkbox"/>	<input type="checkbox"/>	<input type="checkbox"/>
PMX6-17H7-EB45	02925782	17,0	16,8/16,9	6	10,0	8,0	PMX08-xx	<input checked="" type="checkbox"/>	<input type="checkbox"/>	<input type="checkbox"/>	<input type="checkbox"/>	<input type="checkbox"/>	<input checked="" type="checkbox"/>	<input type="checkbox"/>	<input type="checkbox"/>
PMX6-18H7-EB45	02925783	18,0	17,8/17,9	6	10,0	8,0	PMX08-xx	<input checked="" type="checkbox"/>	<input type="checkbox"/>	<input type="checkbox"/>	<input type="checkbox"/>	<input type="checkbox"/>	<input checked="" type="checkbox"/>	<input type="checkbox"/>	<input type="checkbox"/>
PMX6-19H7-EB45	02925784	19,0	18,8/18,9	6	10,0	8,0	PMX08-xx	<input checked="" type="checkbox"/>	<input type="checkbox"/>	<input type="checkbox"/>	<input type="checkbox"/>	<input type="checkbox"/>	<input checked="" type="checkbox"/>	<input type="checkbox"/>	<input type="checkbox"/>
PMX6-20H7-EB45	02925785	20,0	19,8/19,9	6	10,0	8,0	PMX08-xx	<input checked="" type="checkbox"/>	<input type="checkbox"/>	<input type="checkbox"/>	<input type="checkbox"/>	<input type="checkbox"/>	<input checked="" type="checkbox"/>	<input type="checkbox"/>	<input type="checkbox"/>
PMX6-21H7-EB45	02925786	21,0	20,8/20,9	6	10,0	8,0	PMX08-xx	<input checked="" type="checkbox"/>	<input type="checkbox"/>	<input type="checkbox"/>	<input type="checkbox"/>	<input type="checkbox"/>	<input checked="" type="checkbox"/>	<input type="checkbox"/>	<input type="checkbox"/>
PMX6-22H7-EB45	02925030	22,0	21,8/21,9	8	12,0	12,0	PMX12-xx	<input checked="" type="checkbox"/>	<input type="checkbox"/>	<input type="checkbox"/>	<input type="checkbox"/>	<input type="checkbox"/>	<input checked="" type="checkbox"/>	<input type="checkbox"/>	<input type="checkbox"/>
PMX6-23H7-EB45	02925031	23,0	22,8/22,9	8	12,0	12,0	PMX12-xx	<input checked="" type="checkbox"/>	<input type="checkbox"/>	<input type="checkbox"/>	<input type="checkbox"/>	<input type="checkbox"/>	<input checked="" type="checkbox"/>	<input type="checkbox"/>	<input type="checkbox"/>
PMX6-24H7-EB45	02925032	24,0	23,813/23,9	8	12,0	12,0	PMX12-xx	<input checked="" type="checkbox"/>	<input type="checkbox"/>	<input type="checkbox"/>	<input type="checkbox"/>	<input type="checkbox"/>	<input checked="" type="checkbox"/>	<input type="checkbox"/>	<input type="checkbox"/>
PMX6-25H7-EB45	02925033	25,0	24,8/24,9	8	12,0	12,0	PMX12-xx	<input checked="" type="checkbox"/>	<input type="checkbox"/>	<input type="checkbox"/>	<input type="checkbox"/>	<input type="checkbox"/>	<input checked="" type="checkbox"/>	<input type="checkbox"/>	<input type="checkbox"/>
PMX6-26H7-EB45	02925034	26,0	25,8/25,9	8	12,0	12,0	PMX12-xx	<input checked="" type="checkbox"/>	<input type="checkbox"/>	<input type="checkbox"/>	<input type="checkbox"/>	<input type="checkbox"/>	<input checked="" type="checkbox"/>	<input type="checkbox"/>	<input type="checkbox"/>
PMX6-27H7-EB45	02925035	27,0	26,8/26,9	8	12,0	12,0	PMX12-xx	<input checked="" type="checkbox"/>	<input type="checkbox"/>	<input type="checkbox"/>	<input type="checkbox"/>	<input type="checkbox"/>	<input checked="" type="checkbox"/>	<input type="checkbox"/>	<input type="checkbox"/>
PMX6-28H7-EB45	02925036	28,0	27,8/27,9	8	12,0	12,0	PMX12-xx	<input checked="" type="checkbox"/>	<input type="checkbox"/>	<input type="checkbox"/>	<input type="checkbox"/>	<input type="checkbox"/>	<input checked="" type="checkbox"/>	<input type="checkbox"/>	<input type="checkbox"/>
PMX6-29H7-EB45	02925037	29,0	28,8/28,9	8	12,0	12,0	PMX12-xx	<input checked="" type="checkbox"/>	<input type="checkbox"/>	<input type="checkbox"/>	<input type="checkbox"/>	<input type="checkbox"/>	<input checked="" type="checkbox"/>	<input type="checkbox"/>	<input type="checkbox"/>
PMX6-30H7-EB45	02925038	30,0	29,8/29,9	8	12,0	12,0	PMX12-xx	<input checked="" type="checkbox"/>	<input type="checkbox"/>	<input type="checkbox"/>	<input type="checkbox"/>	<input type="checkbox"/>	<input checked="" type="checkbox"/>	<input type="checkbox"/>	<input type="checkbox"/>
PMX6-31H7-EB45	02925039	31,0	30,8/30,9	8	12,0	12,0	PMX12-xx	<input checked="" type="checkbox"/>	<input type="checkbox"/>	<input type="checkbox"/>	<input type="checkbox"/>	<input type="checkbox"/>	<input checked="" type="checkbox"/>	<input type="checkbox"/>	<input type="checkbox"/>
PMX6-32H7-EB45	02925040	32,0	31,8/31,9	8	12,0	12,0	PMX12-xx	<input checked="" type="checkbox"/>	<input type="checkbox"/>	<input type="checkbox"/>	<input type="checkbox"/>	<input type="checkbox"/>	<input checked="" type="checkbox"/>	<input type="checkbox"/>	<input type="checkbox"/>

*Więcej informacji na temat tego, jakie wiertło używać, można znaleźć na stronie 8

■ Wyrób standardowy. □ Standard niemagazynowany.

Wspólne oprawki do rozwiercania otworów przelotowych i nieprzelotowych

Ø 7,75-60,500 mm / 0.305-2.381"

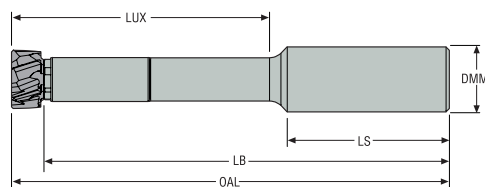

- Wybór geometrii, patrz str. 333-336
- Parametry skrawania, patrz strona (strony) 355-362



Oznaczenie	Numer produktu	Materiał oprawki	DC	OAL	LB	LS	LUX	DMM
			mm	mm	mm	mm	mm	mm
PMX05-02800-10N1	03123012	Stal	7,75 - 9,9	69,0	63,0	40,0	28,0	10,0
PMX05-04100-10N1	02929923	Stal	7,75 - 9,9	84,0	78,0	40,0	41,0	10,0
PMX05-10000-10N1	03123013	Stal	7,75 - 9,9	143,0	137,0	40,0	100,0	10,0
PMX06-03700-12N1	02925828	Stal	9,901 - 14,499	84,0	77,0	45,0	37,0	12,0
PMX06-05700-12N1	02925829	Stal	9,901 - 14,499	104,0	97,0	45,0	57,0	12,0
PMX06-12000-12N1	02925830	Stal	9,901 - 14,499	167,0	160,0	45,0	120,0	12,0
PMX06HM-12000-12N1	02925831	Węglik	9,901 - 14,499	167,0	160,0	45,0	120,0	12,0
PMX08-04600-20N1	02925832	Stal	14,5 - 21,499	99,0	89,0	50,0	46,0	20,0
PMX08-08200-20N1	02925833	Stal	14,5 - 21,499	135,0	125,0	50,0	82,0	20,0
PMX08-14500-20N1	02925834	Stal	14,5 - 21,499	198,0	188,0	50,0	145,0	20,0
PMX08HM-14500-20N1	02925835	Węglik	14,5 - 21,499	198,0	188,0	50,0	145,0	20,0
PMX12-06800-25N1	02925836	Stal	21,5 - 32,499	127,0	115,0	56,0	68,0	25,0
PMX12-10400-25N1	02925837	Stal	21,5 - 32,499	163,0	151,0	56,0	104,0	25,0
PMX12-17000-25N1	02925838	Stal	21,5 - 32,499	229,0	217,0	56,0	170,0	25,0
PMX12HM-17000-25N1	02925839	Węglik	21,5 - 32,499	229,0	217,0	56,0	170,0	25,0
PMX16-06300-32N1	02925840	Stal	32,5 - 60,5	124,0	110,0	60,0	63,0	32,0
PMX16-12700-32N1	02925841	Stal	32,5 - 60,5	188,0	174,0	60,0	127,0	32,0
PMX16-17000-32N1	02925842	Stal	32,5 - 60,5	231,0	217,0	60,0	170,0	32,0
PMX16HM-17000-32N1	02925843	Węglik	32,5 - 60,5	231,0	217,0	61,0	170,0	32,0

Części zamienne, zawarte w dostawie

Dla chwytu	Dla Ø (mm)	Klucz mocujący	Zestaw mocujący	Zestaw do chłodziwa	Śruba zaślepiająca, otwór nieprzelotowy	Śruba zaślepiająca, otwór przelotowy
PMX05	7,75-9,900	1.5SMS795	PMX05-CLKI	RT05-KI	SB05	ST05
PMX06	9,901-14,499	2SMS795	PMX06-CLKI	RT06-KI	SB06	ST06
PMX08	14,5-21,499	2.5SMS795	PMX08-CLKI	RT08-KI	SB08	ST08
PMX12	21,5-32,499	4SMS795	PMX12-CLKI	RT12-KI	SB12	ST12
PMX16	32,5-60	5SMS795	PMX16-CLKI	-	SB16	ST16

* Części zamienne tylko dla PMX16. W przypadku PMX16 śruby są również używane do mocowania.

Aksesoria

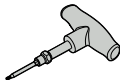
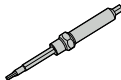
Dla \varnothing (mm)	Wielkość oprawki	Numer produktu	Klucz dynam.	Numer produktu	Wkładka wymienna	Numer produktu	Klucz dynam.	Numer produktu	Wkładka wymienna	Wielk. mom.
										
7,750-9,900	PMX05	03178196	H00-1505-24	03178237	H00-1.5-27	-	-	-	-	0,5 Nm
9,901-14,499	PMX06	03178197	H00-2009-33	03178238	H00-2.0-33	-	-	-	-	0,9 Nm
14,500-21,499	PMX08	03178199	H00-2512-40	03178240	H00-2.5-40	-	-	-	-	1,2 Nm
21,500-32,499	PMX12	03178201	H00-4020-60	03178242	H00-4.0-60	-	-	-	-	2,0 Nm
32,500-60,500	PMX16	-	-	-	-	03271887	H00T-5050	02506761	H00T-5,0	5,0 Nm

Wstęp

Wiercenie

Rozwiercanie

Wytaczanie

Załącznik

Oprawka do otworów nieprzelotowych

Ø 7,75-60,500 mm / 0.305-2.381"

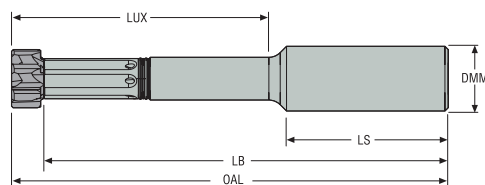

- Wybór geometrii, patrz str. 333-336
- Parametry skrawania, patrz strona (strony) 355-362



Oznaczenie	Numer produktu	Materiał oprawki	DC	OAL	LB	LS	LUX	DMM
			mm	mm	mm	mm	mm	mm
PMX05B-02800-10N1	03144322	Stal	7,75 - 9,9	69,0	63,0	40,0	28,0	10,0
PMX05B-04100-10N1	03144323	Stal	7,75 - 9,9	84,0	78,0	40,0	41,0	10,0
PMX05B-10000-10N1	03144324	Stal	7,75 - 9,9	143,0	137,0	40,0	100,0	10,0
PMX06B-03700-12N1	03075433	Stal	9,901 - 14,499	84,0	77,0	45,0	37,0	12,0
PMX06B-05700-12N1	03075434	Stal	9,901 - 14,499	104,0	97,0	45,0	57,0	12,0
PMX06B-12000-12N1	03075435	Stal	9,901 - 14,499	167,0	160,0	45,0	120,0	12,0
PMX06BHM-12000-12N1	03075436	Węglik	9,901 - 14,499	167,0	160,0	45,0	120,0	12,0
PMX08B-04600-20N1	03075437	Stal	14,5 - 21,499	99,0	89,0	50,0	46,0	20,0
PMX08B-08200-20N1	03075438	Stal	14,5 - 21,499	135,0	125,0	50,0	82,0	20,0
PMX08B-14500-20N1	03075439	Stal	14,5 - 21,499	198,0	188,0	50,0	145,0	20,0
PMX08BHM-14500-20N1	03075440	Węglik	14,5 - 21,499	198,0	188,0	50,0	145,0	20,0
PMX12B-06800-25N1	03075441	Stal	21,5 - 32,499	127,0	115,0	56,0	68,0	25,0
PMX12B-10400-25N1	03075442	Stal	21,5 - 32,499	163,0	151,0	56,0	104,0	25,0
PMX12B-17000-25N1	03075443	Stal	21,5 - 32,499	229,0	217,0	56,0	170,0	25,0
PMX12BHM-17000-25N1	03075444	Węglik	21,5 - 32,499	229,0	217,0	56,0	170,0	25,0
PMX16B-06300-32N1	03075445	Stal	32,5 - 60,5	124,0	110,0	61,0	63,0	32,0
PMX16B-12700-32N1	03075446	Stal	32,5 - 60,5	188,0	174,0	61,0	127,0	32,0
PMX16B-17000-32N1	03075447	Stal	32,5 - 60,5	231,0	217,0	61,0	170,0	32,0
PMX16BHM-17000-32N1	03075448	Węglik	32,5 - 60,5	231,0	217,0	61,0	170,0	32,0

Części zamienne, zawarte w dostawie

Dla chwytu	Dla Ø (mm)	Klucz mocujący	Zestaw mocujący	Śruba zaślepiająca, otwór nieprzelotowy
PMX05B	7,75-9,900	1.5SMS795	PMX05-CLKI	SB05
PMX06B	9,901-14,499	2SMS795	PMX06-CLKI	SB06
PMX08B	14,500-21,499	2.5SMS795	PMX08-CLKI	SB08
PMX12B	21,500-32,499	4SMS795	PMX12-CLKI	SB12
PMX16B	32,500-60,000	5SMS795	PMX16-CLKI	SB16

* Części zamienne tylko dla PMX16. W przypadku PMX16 śruby są również używane do mocowania.

Aksesoria

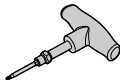
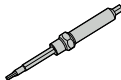
Dł. Ø (mm)	Wielkość oprawki	Numer produktu	Klucz dynam.	Numer produktu	Wkładka wymienna	Numer produktu	Klucz dynam.	Numer produktu	Wkładka wymienna	Wielk. mom.
										
7,750-9,900	PMX05	03178196	H00-1505-24	03178237	H00-1.5-27	-	-	-	-	0,5 Nm
9,901-14,499	PMX06	03178197	H00-2009-33	03178238	H00-2.0-33	-	-	-	-	0,9 Nm
14,500-21,499	PMX08	03178199	H00-2512-40	03178240	H00-2.5-40	-	-	-	-	1,2 Nm
21,500-32,499	PMX12	03178201	H00-4020-60	03178242	H00-4.0-60	-	-	-	-	2,0 Nm
32,500-60,500	PMX16	-	-	-	-	03271887	H00T-5050	02506761	H00T-5,0	5,0 Nm

Wstęp

Wiercenie

Rozwiercanie

Wytaczanie

Załącznik

Regulowana oprawka do otworów przelotowych

Ø 7,75-60,500 mm / 0.305-2.381"

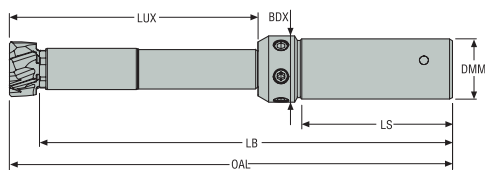

- Wybór geometrii, patrz str. 333-336
- Parametry skrawania, patrz strona (strony) 355-362

Oznaczenie	Numer produktu	DC	OAL	LB	LS	LUX	DMM
		mm	mm	mm	mm	mm	mm
PMX05T-AD-04100-16N1	03271918	7,75 - 9,9	102,0	96,0	48,0	41,0	16,0
PMX06T-AD-05700-16N1	03002833	9,901 - 14,499	117,0	110,0	48,0	57,0	16,0
PMX08T-AD-08200-20N1	03002835	14,5 - 21,499	147,0	137,0	50,0	82,0	20,0
PMX12T-AD-10400-25N1	03002837	21,5 - 32,499	179,0	167,0	56,0	104,0	25,0
PMX16T-AD-12700-32N1	03002839	32,5 - 60,5	214,0	200,0	60,0	127,0	32,0

Części zamienne, zawarte w dostawie

Dla chwytu	Dla Ø (mm)	Klucz mocujący	Pierścień do chłodziwa	Klucz ustawczy	Końcówka do ustawiania	Śruba ustawcza
PMX05T	7,750-9,900	1.5SMS795	RT05-KI	2SMS795	PMX05-MSTR	HCM4X4X0.5/ISO4026
PMX06T	9,901-14,499	2SMS795	RT06-KI	-	PMX06-MSTR	HCM4X4X0.5/ISO4026
PMX08T	14,50-21,499	2.5SMS795	RT08-KI	-	PMX08-MSTR	HCM5X5X0.5/ISO4026
PMX12T	21,50-32,499	4SMS795	RT12-KI	3SMS795	PMX12-MSTR	HCM6X6X0.75/ISO4026
PMX16T	32,50-60,000	5SMS795	-	3SMS795	-	HCM6X6X0.75/ISO4026

Akcesoria

Dla Ø (mm)	Wielkość oprawki	Numer produktu	Klucz dynam.	Numer produktu	Wkładka wymienna	Numer produktu	Klucz dynam.	Numer produktu	Wkładka wymienna	Wielk. mom.
7,750-9,900	PMX05	03178196	H00-1505-24	03178237	H00-1.5-27	-	-	-	-	0,5 Nm
9,901-14,499	PMX06	03178197	H00-2009-33	03178238	H00-2.0-33	-	-	-	-	0,9 Nm
14,500-21,499	PMX08	03178199	H00-2512-40	03178240	H00-2.5-40	-	-	-	-	1,2 Nm
21,500-32,499	PMX12	03178201	H00-4020-60	03178242	H00-4.0-60	-	-	-	-	2,0 Nm
32,500-60,500	PMX16	-	-	-	-	03271887	H00T-5050	02506761	H00T-5,0	5,0 Nm

Uwaga: Zestaw naprawczy PMxx-CLKI nie jest odpowiedni dla typu PMX FL i AD

Regulowana oprawka do otworów nieprzelotowych

Ø 7,75-60,500 mm / 0.305-2.381"

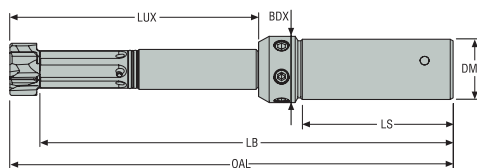

- Wybór geometrii, patrz str. 333-336
- Parametry skrawania, patrz strona (strony) 355-362

Oznaczenie	Numer produktu	DC	OAL	LB	LS	LUX	DMM
		mm	mm	mm	mm	mm	mm
PMX05B-AD-04100-16N1	03271919	7,75 - 9,9	102,0	96,0	48,0	41,0	16,0
PMX06B-AD-05700-16N1	03002834	9,901 - 14,499	117,0	110,0	48,0	57,0	16,0
PMX08B-AD-08200-20N1	03002836	14,5 - 21,499	147,0	137,0	50,0	82,0	20,0
PMX12B-AD-10400-25N1	03002838	21,5 - 32,499	179,0	167,0	56,0	104,0	25,0
PMX16B-AD-12700-32N1	03002840	32,5 - 60,5	214,0	200,0	60,0	127,0	32,0

Części zamienne, zawarte w dostawie

Dł. chwytu	Dł. Ø (mm)	Klucz mocujący	Klucz ustawczy	Końcówka do ustawiania	Śruba ustawcza
PMX05B	7,750-9,900	1.5SMS795	2SMS795	PMX05-MSTR	HCM4X4X0.5/ISO4026
PMX06B	9,901-14,499	2SMS795	-	PMX06-MSTR	HCM4X4X0.5/ISO4026
PMX08B	14,50-21,499	2.5SMS795	-	PMX08-MSTR	HCM5X5X0.5/ISO4026
PMX12B	21,50-32,499	4SMS795	3SMS795	PMX12-MSTR	HCM6X6X0.75/ISO4026
PMX16B	32,50-60,000	5SMS795	3SMS795	-	HCM6X6X0.75/ISO4026

Akcesoria

Dł. Ø (mm)	Wielkość oprawki	Numer produktu	Klucz dynam.	Numer produktu	Wkładka wymienna	Numer produktu	Klucz dynam.	Numer produktu	Wkładka wymienna	Wielk. mom.
7,750-9,900	PMX05	03178196	H00-1505-24	03178237	H00-1.5-27	-	-	-	-	0,5 Nm
9,901-14,499	PMX06	03178197	H00-2009-33	03178238	H00-2.0-33	-	-	-	-	0,9 Nm
14,500-21,499	PMX08	03178199	H00-2512-40	03178240	H00-2.5-40	-	-	-	-	1,2 Nm
21,500-32,499	PMX12	03178201	H00-4020-60	03178242	H00-4.0-60	-	-	-	-	2,0 Nm
32,500-60,500	PMX16	-	-	-	-	03271887	H00T-5050	02506761	H00T-5,0	5,0 Nm

Uwaga: Zestaw naprawczy PMxx-CLKI nie jest odpowiedni dla typu PMX FL i AD

Oprawka pływająca do otworów przelotowych

Ø 7,75-60,500 mm / 0.305-2.381"

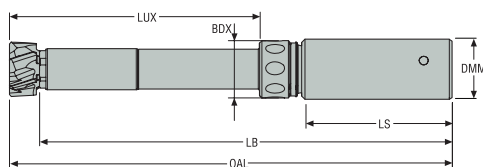



- Wybór geometrii, patrz str. 333-336
- Parametry skrawania, patrz strona (strony) 355-362

Oznaczenie	Numer produktu	DC	OAL	LB	LS	LUX	DMM
		mm	mm	mm	mm	mm	mm
PMX05T-FL-04100-16N1	03197751	7,75 - 9,9	102,0	96,0	48,0	41,0	16,0
PMX06T-FL-05700-16N1	03002825	9,901 - 14,499	117,0	110,0	48,0	57,0	16,0
PMX08T-FL-08200-20N1	03002827	14,5 - 21,499	147,0	137,0	50,0	82,0	20,0
PMX12T-FL-10400-25N1	03002829	21,5 - 32,499	179,0	167,0	56,0	104,0	25,0
PMX16T-FL-12700-32N1	03002831	32,5 - 60,5	214,0	200,0	60,0	127,0	32,0

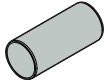
Części zamienne, zawarte w dostawie

Dł. chwytu	Dł. Ø (mm)	Klucz mocujący	Pierścień do chłodziwa
			
PMX05T	7,750-9,900	1.5SMS795	RT05-KI
PMX06T	9,901-14,499	2SMS795	RT06-KI
PMX08T	14,50-21,499	2.5SMS795	RT08-KI
PMX12T	21,50-32,499	4SMS795	RT12-KI
PMX16T	32,50-60,000	5SMS795	-

Akcesoria

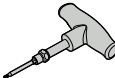
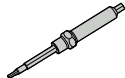
Dł. Ø (mm)	Wielkość oprawki	Numer produktu	Klucz dynam.	Numer produktu	Wkładka wymienna	Numer produktu	Klucz dynam.	Numer produktu	Wkładka wymienna	Wielk. mom.
										
7,750-9,900	PMX05	03178196	H00-1505-24	03178237	H00-1.5-27	-	-	-	-	0,5 Nm
9,901-14,499	PMX06	03178197	H00-2009-33	03178238	H00-2.0-33	-	-	-	-	0,9 Nm
14,500-21,499	PMX08	03178199	H00-2512-40	03178240	H00-2.5-40	-	-	-	-	1,2 Nm
21,500-32,499	PMX12	03178201	H00-4020-60	03178242	H00-4.0-60	-	-	-	-	2,0 Nm
32,500-60,500	PMX16	-	-	-	-	03271887	H00T-5050	02506761	H00T-5,0	5,0 Nm

Uwaga: Zestaw naprawczy PMxx-CLKI nie jest odpowiedni dla typu PMX FL i AD

Oprawka pływająca do otworów nieprzelotowych

Ø 7,75-60,500 mm / 0.305-2.381"

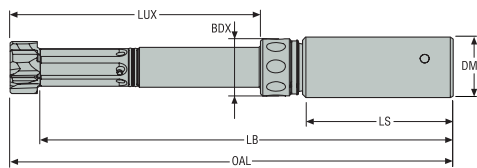

- Wybór geometrii, patrz str. 333-336
- Parametry skrawania, patrz strona (strony) 355-362

Oznaczenie	Numer produktu	DC	OAL	LB	LS	LUX	DMM
		mm	mm	mm	mm	mm	mm
PMX05B-FL-04100-16N1	03271916	7,75 - 9,9	102,0	96,0	48,0	41,0	16,0
PMX06B-FL-05700-16N1	03002826	9,901 - 14,499	117,0	110,0	48,0	57,0	16,0
PMX08B-FL-08200-20N1	03002828	14,5 - 21,499	147,0	137,0	50,0	82,0	20,0
PMX12B-FL-10400-25N1	03002830	21,5 - 32,499	179,0	167,0	56,0	104,0	25,0
PMX16B-FL-12700-32N1	03002832	32,5 - 60,5	214,0	200,0	60,0	127,0	32,0

Części zamienne, zawarte w dostawie

Dłg. chwytu	Dłg. Ø (mm)	Klucz mocujący
PMX05B	7,750-9,900	1.5SMS795
PMX06B	9,901-14,499	2SMS795
PMX08B	14,50-21,499	2.5SMS795
PMX12B	21,50-32,499	4SMS795
PMX16B	32,50-60,500	5SMS795

Akcesoria

Dłg. Ø (mm)	Wielkość oprawki	Numer produktu	Klucz dynam.	Numer produktu	Wkładka wymienna	Numer produktu	Klucz dynam.	Numer produktu	Wkładka wymienna	Wielk. mom.
7,750-9,900	PMX05	03178196	H00-1505-24	03178237	H00-1.5-27	-	-	-	-	0,5 Nm
9,901-14,499	PMX06	03178197	H00-2009-33	03178238	H00-2.0-33	-	-	-	-	0,9 Nm
14,500-21,499	PMX08	03178199	H00-2512-40	03178240	H00-2.5-40	-	-	-	-	1,2 Nm
21,500-32,499	PMX12	03178201	H00-4020-60	03178242	H00-4.0-60	-	-	-	-	2,0 Nm
32,500-60,500	PMX16	-	-	-	-	03271887	H00T-5050	02506761	H00T-5,0	5,0 Nm

Uwaga: Zestaw naprawczy PMxx-CLKI nie jest odpowiedni dla typu PMX FL i AD

Końcówki do otworów przelotowych i nieprzelotowych, Narzędzia specjalne

Ø 7,75-60,500 mm / 0.305-2.381"

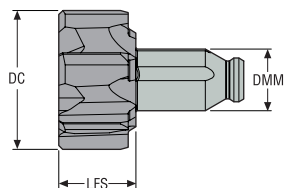

- Wybór geometrii, patrz str. 333-336
- Parametry skrawania, patrz strona (strony) 355-362

Oznaczenie	DCN	DCX	LFS	DMM	Wielkość korpusu	Geometrie	Gatunki												
	mm Cal.	mm Cal.	mm Cal.	mm Cal.			H15	CP20	RX2000	RK2050	RK1550	CF	RX1500	RN2010	RM2020	RM2090	RS2090		
PMX5-7.75-XX-XXXX	7,75 0.305	9,9 0.390	6,0 0.236	4,5 0.177	6	PMX05-xx	EB45 EB845 EB30	<input type="checkbox"/>	<input type="checkbox"/>	<input type="checkbox"/>	<input type="checkbox"/>	<input type="checkbox"/>	<input type="checkbox"/>	-	-	<input type="checkbox"/>	<input type="checkbox"/>	<input type="checkbox"/>	<input type="checkbox"/>
PMX5-10.0-XX-XXXX	9,901 0.390	14,499 0.571	7,0 0.276	6,0 0.236	6	PMX06-xx	EB45 EB845 EB30	<input type="checkbox"/>	<input type="checkbox"/>	<input type="checkbox"/>	<input type="checkbox"/>	<input type="checkbox"/>	<input type="checkbox"/>	<input type="checkbox"/>	<input type="checkbox"/>	<input type="checkbox"/>	<input type="checkbox"/>	<input type="checkbox"/>	<input type="checkbox"/>
PMX5-14.5-XX-XXXX	14,5 0.571	21,499 0.846	10,0 0.394	8,0 0.315	6	PMX08-xx	EB45 EB845 EB30	<input type="checkbox"/>	<input type="checkbox"/>	<input type="checkbox"/>	<input type="checkbox"/>	<input type="checkbox"/>	<input type="checkbox"/>	<input type="checkbox"/>	<input type="checkbox"/>	<input type="checkbox"/>	<input type="checkbox"/>	<input type="checkbox"/>	<input type="checkbox"/>
PMX5-21.5-XX-XXXX	21,5 0.846	32,499 1.279	12,0 0.472	12,0 0.472	8	PMX12-XX	EB45 EB845 EB30	<input type="checkbox"/>	<input type="checkbox"/>	<input type="checkbox"/>	<input type="checkbox"/>	<input type="checkbox"/>	<input type="checkbox"/>	<input type="checkbox"/>	<input type="checkbox"/>	<input type="checkbox"/>	<input type="checkbox"/>	<input type="checkbox"/>	<input type="checkbox"/>
PMX5-32.5-XX-XXXX	32,5 1.280	60,5 2.382	14,0 0.551	16,0 0.630	10	PMX16-xx	EB45 EB845 EB30	<input type="checkbox"/>	<input type="checkbox"/>	<input type="checkbox"/>	<input type="checkbox"/>	<input type="checkbox"/>	<input type="checkbox"/>	<input type="checkbox"/>	<input type="checkbox"/>	<input type="checkbox"/>	<input type="checkbox"/>	<input type="checkbox"/>	<input type="checkbox"/>

= Pozycja niestandardowa.

Uwaga: Przy zamawianiu rozwiertaka Nanofix dla średnic pośrednich należy podać średnicę i tolerancję rozwiercanego otworu.

Przykładowe zamówienie: PMX5-16.515 P7-EB45 RM2020.

Końcówki do otworów przelotowych, Narzędzia specjalne

Ø 7,75-60,500 mm / 0.305-2.381"

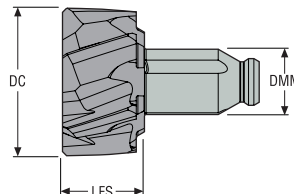

- Wybór geometrii, patrz str. 333-336
- Parametry skrawania, patrz strona (strony) 355-362

Oznaczenie	DCN	DCX	LFS	DMM	Wielkość korpusu	Geometrie	Gatunki											
	mm Cal.	mm Cal.	mm Cal.	mm Cal.				H15	CP20	RX2000	RK2050	RK1550	CF	RX1500	RN2010	RM2020	RM2090	RS2090
PMX6-7.75-XX-XXXX	7,75 0.305	9,9 0.390	6,0 0.236	4,5 0.177	6	PMX05-xx	EB45 EB845 EB30	<input type="checkbox"/>	<input type="checkbox"/>	<input type="checkbox"/>	<input type="checkbox"/>	<input type="checkbox"/>	-	-	<input type="checkbox"/>	<input type="checkbox"/>	<input type="checkbox"/>	<input type="checkbox"/>
PMX6-10.0-XX-XXXX	9,901 0.390	14,499 0.571	7,0 0.276	6,0 0.236	6	PMX06-xx	EB45 EB845 EB30	<input type="checkbox"/>	<input type="checkbox"/>	<input type="checkbox"/>	<input type="checkbox"/>	<input type="checkbox"/>	<input type="checkbox"/>	<input type="checkbox"/>	<input type="checkbox"/>	<input type="checkbox"/>	<input type="checkbox"/>	<input type="checkbox"/>
PMX6-14.5-XX-XXXX	14,5 0.571	21,499 0.846	10,0 0.394	8,0 0.315	6	PMX08-xx	EB45 EB845 EB30	<input type="checkbox"/>	<input type="checkbox"/>	<input type="checkbox"/>	<input type="checkbox"/>	<input type="checkbox"/>	<input type="checkbox"/>	<input type="checkbox"/>	<input type="checkbox"/>	<input type="checkbox"/>	<input type="checkbox"/>	<input type="checkbox"/>
PMX6-21.5-XX-XXXX	21,5 0.846	32,499 1.279	12,0 0.472	12,0 0.472	8	PMX12-XX	EB45 EB845 EB30	<input type="checkbox"/>	<input type="checkbox"/>	<input type="checkbox"/>	<input type="checkbox"/>	<input type="checkbox"/>	<input type="checkbox"/>	<input type="checkbox"/>	<input type="checkbox"/>	<input type="checkbox"/>	<input type="checkbox"/>	<input type="checkbox"/>
PMX6-32.5-XX-XXXX	32,5 1.280	60,5 2.382	14,0 0.551	16,0 0.630	10	PMX16-xx	EB45 EB845 EB30	<input type="checkbox"/>	<input type="checkbox"/>	<input type="checkbox"/>	<input type="checkbox"/>	<input type="checkbox"/>	<input type="checkbox"/>	<input type="checkbox"/>	<input type="checkbox"/>	<input type="checkbox"/>	<input type="checkbox"/>	<input type="checkbox"/>

= Pozycja niestandardowa.

Uwaga: Przy zamawianiu rozwiertaka Nanofix dla średnic pośrednich należy podać średnicę i tolerancję rozwiercanego otworu.

Przykładowe zamówienie: PMX6-16.515 P7-EB45 RM2020.

Do otworów nieprzelotowych, Narzędzia specjalne

Ø 7,75-60,500 mm / 0.305-2.381"

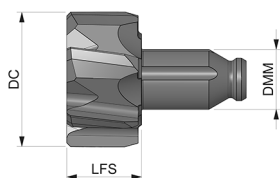

- Wybór geometrii, patrz str. 333-336
- Parametry skrawania, patrz strona (strony) 355-362

Oznaczenie	DCN	DCX	LFS	DMM	Wielkość korpusu	Geometrie	Gatunki												
	mm Cal.	mm Cal.	mm Cal.	mm Cal.			H15	CP20	RX2000	RK2050	RK1550	CF	RX1500	RN2010	RM2020	RM2090	RS2090		
PMX4-7.75-XX-XXXX	7,75 0.305	9,9 0.390	6,0 0.236	4,5 0.177	6	PMX05-xx	EB45 EB84 EB30	<input type="checkbox"/>	<input type="checkbox"/>	<input type="checkbox"/>	<input type="checkbox"/>	<input type="checkbox"/>	<input type="checkbox"/>	-	-	<input type="checkbox"/>	<input type="checkbox"/>	<input type="checkbox"/>	<input type="checkbox"/>
PMX4-10.0-XX-XXXX	9,901 0.390	14,499 0.571	7,0 0.276	6,0 0.236	6	PMX06-xx	EB45 EB84 EB30	<input type="checkbox"/>	<input type="checkbox"/>	<input type="checkbox"/>	<input type="checkbox"/>	<input type="checkbox"/>	<input type="checkbox"/>	<input type="checkbox"/>	<input type="checkbox"/>	<input type="checkbox"/>	<input type="checkbox"/>	<input type="checkbox"/>	<input type="checkbox"/>
PMX4-14.5-XX-XXXX	14,5 0.571	21,499 0.846	10,0 0.394	8,0 0.315	6	PMX08-xx	EB45 EB84 EB30	<input type="checkbox"/>	<input type="checkbox"/>	<input type="checkbox"/>	<input type="checkbox"/>	<input type="checkbox"/>	<input type="checkbox"/>	<input type="checkbox"/>	<input type="checkbox"/>	<input type="checkbox"/>	<input type="checkbox"/>	<input type="checkbox"/>	<input type="checkbox"/>
PMX4-21.5-XX-XXXX	21,5 0.846	32,499 1.279	12,0 0.472	12,0 0.472	8	PMX12-xx	EB45 EB84 EB30	<input type="checkbox"/>	<input type="checkbox"/>	<input type="checkbox"/>	<input type="checkbox"/>	<input type="checkbox"/>	<input type="checkbox"/>	<input type="checkbox"/>	<input type="checkbox"/>	<input type="checkbox"/>	<input type="checkbox"/>	<input type="checkbox"/>	<input type="checkbox"/>
PMX4-32.5-XX-XXXX	32,5 1.280	60,5 2.382	14,0 0.551	16,0 0.630	10	PMX16-xx	EB45 EB84 EB30	<input type="checkbox"/>	<input type="checkbox"/>	<input type="checkbox"/>	<input type="checkbox"/>	<input type="checkbox"/>	<input type="checkbox"/>	<input type="checkbox"/>	<input type="checkbox"/>	<input type="checkbox"/>	<input type="checkbox"/>	<input type="checkbox"/>	<input type="checkbox"/>

= Pozycja niestandardowa.

Uwaga: Przy zamawianiu rozwiertaka Nanofix dla średnic pośrednich należy podać średnicę i tolerancję rozwieranego otworu.

Przykładowe zamówienie: PMX4-16.515 P7-EB45 RM2020.

Głowice do otworów przelotowych i nieprzelotowych

∅ 10,00-32,500 mm / 0.393-1.279"

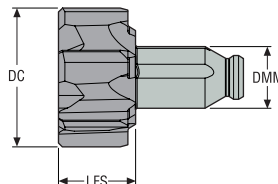

- Wybór geometrii, patrz str. 333-336
- Parametry skrawania, patrz strona (strony) 355-362

Oznaczenie	DCN	DCX	LFS	DMM	Wielkość korpusu	Geometrie	Gatunki											
	mm Cal.	mm Cal.	mm Cal.	mm Cal.				H15	CP20	RX2000	RK2050	RK1550	CF	RX1500	RN2010	RM2020	RM2090	RS2090
PMX8-10.0-XX-XXXX	10,0 0.394	14,499 0.571	7,0 0.276	6,0 0.236	6	PMX06-xx	EB45 EB845 EB30	<input type="checkbox"/>	<input type="checkbox"/>	<input type="checkbox"/>	<input type="checkbox"/>	<input type="checkbox"/>	<input type="checkbox"/>	<input type="checkbox"/>	<input type="checkbox"/>	<input type="checkbox"/>	<input type="checkbox"/>	<input type="checkbox"/>
PMX8-14.5-XX-XXXX	14,5 0.571	21,499 0.846	10,0 0.394	8,0 0.315	6	PMX08-xx	EB45 EB845 EB30	<input type="checkbox"/>	<input type="checkbox"/>	<input type="checkbox"/>	<input type="checkbox"/>	<input type="checkbox"/>	<input type="checkbox"/>	<input type="checkbox"/>	<input type="checkbox"/>	<input type="checkbox"/>	<input type="checkbox"/>	<input type="checkbox"/>
PMX8-21.5-XX-XXXX	21,5 0.846	32,499 1.279	12,0 0.472	12,0 0.472	8	PMX12-xx	EB45 EB845 EB30	<input type="checkbox"/>	<input type="checkbox"/>	<input type="checkbox"/>	<input type="checkbox"/>	<input type="checkbox"/>	<input type="checkbox"/>	<input type="checkbox"/>	<input type="checkbox"/>	<input type="checkbox"/>	<input type="checkbox"/>	<input type="checkbox"/>

= Pozycja niestandardowa.

Uwaga: Przy zamawianiu rozwiertaka Nanofix dla średnic pośrednich należy podać średnicę i tolerancję rozwiercanego otworu.

Przykładowe zamówienie: PMX8-16.515 P7-EB45 RM2020.

Rozwiązywanie problemów

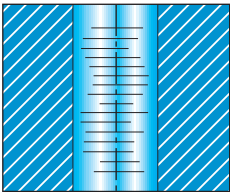
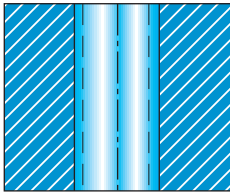
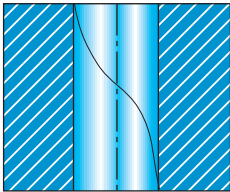
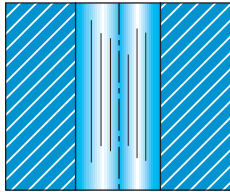
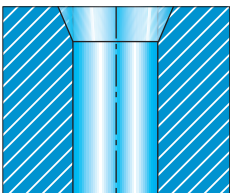
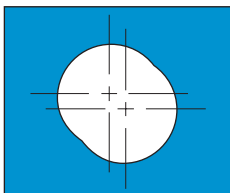
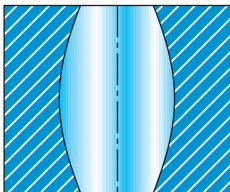
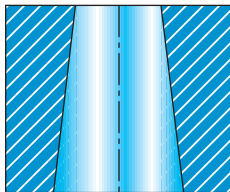
<p>Zła jakość powierzchni</p> <ul style="list-style-type: none"> • Sprawdzić naddatek na obróbkę • Poprawić warunki chłodzenia (wylot, ciśnienie, ilość) • Zredukować posuw 	<p>Za duża średnica</p> <ul style="list-style-type: none"> • Poprawić centrowanie (detal/narzędzie) 
<p>Ślady wycofywania</p> <ul style="list-style-type: none"> • Poprawić warunki chłodzenia (wylot, ciśnienie, jakość) • Poprawić centrowanie (detal/narzędzie) • Zredukować posuw wyjścia 	<p>Karby</p> <ul style="list-style-type: none"> • Poprawić centrowanie (detal/narzędzie) • Sprawdzić naddatek materiału 
<p>Stożkowate wejście</p> <ul style="list-style-type: none"> • Zmniejszyć posuw • Poprawić centrowanie (detal/narzędzie) • Zredukować bicie promieniowe 	<p>Mimośród/Owal</p> <ul style="list-style-type: none"> • Poprawić mocowanie (deformacja części) • Sprawdzić naddatek na obróbkę • Poprawić centrowanie (detal/narzędzie) 
<p>Zniekształcony otwór</p> <ul style="list-style-type: none"> • Poprawić mocowanie (deformacja części) 	<p>Otwór stożkowy</p> <ul style="list-style-type: none"> • Poprawić centrowanie (detal/narzędzie) 

Instrukcje odnośnie ostrzenia

Warunki techniczne

Ściernica diamentowa
wielkość ziarna:

D6 – Dla pierwszego kąta przyłożenia (β_1 – β_3)

D64 – Dla drugiego kąta przyłożenia (β_2)

Ważne:

Zmniejsza średnicę rozwiertaka

Ponowne pokrywanie może zwiększać średnicę rozwiertaka

Maks. bicie na fazach czołowych 10 μm 394 μcala

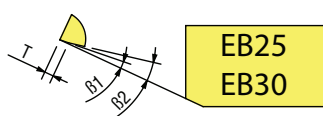

EB25
EB30

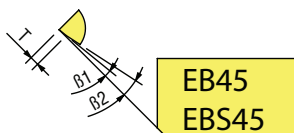

EB45
EBS45

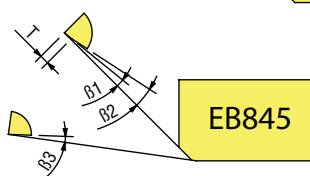

EB845



Z=10

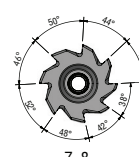

Z=8

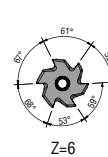

Z=6

Ø Precimaster Plus mm (cale)	β_1	β_2	β_3	T mm (cale)
7,75–9,999 (0.3151–0.3937)	8°	18°	8°	0,20 (0.008)
10,00–14,499 (0.3937–0.5708)	8°	18°	8°	0,20 (0.008)
14,500–21,499 (0.5709–0.8464)	8°	18°	8°	0,20 (0.008)
21,500–32,499 (0.8465–1.2795)	8°	18°	8°	0,25 (0.010)
32,500–60,499 (1.2795–2.3819)	8°	15°	8°	0,30 (0.012)

Parametry skrawania – PM Plus... -EB45 Metryczne

SMG		a _p (°)		f			v _c										
		z=6	z=8 z=10	z=6	z=8	z=10	H15	CP20	RX2000	RK2050	CF	RX1500	RK1550	RN2010	RM2020	RM2090	RS2090
P1	PMXxx ..6 ..8 -EB45	0,10 -0,20	0,10 -0,30	0,30 -0,90	0,40 -1,20	0,50 -1,50	25 (15-30)	60 (30-100)	80 (30-150)	-	180 (90-200)	220 (120-300)	-	-	-	-	-
P2	PMXxx ..6 ..8 -EB45	0,10 -0,20	0,10 -0,30	0,30 -0,90	0,40 -1,20	0,50 -1,50	25 (15-30)	60 (30-100)	80 (30-150)	-	180 (90-200)	220 (120-300)	-	-	-	-	-
P3	PMXxx ..6 ..8 -EB45	0,10 -0,20	0,10 -0,30	0,30 -0,90	0,40 -1,20	0,50 -1,50	25 (15-30)	60 (30-100)	80 (30-150)	-	180 (90-200)	220 (120-300)	-	-	-	-	-
P4	PMXxx ..6 ..8 -EB45	0,10 -0,20	0,10 -0,30	0,20 -0,70	0,30 -1,00	0,40 -1,20	20 (10-25)	50 (30-80)	60 (30-120)	-	120 (80-150)	180 (90-200)	-	-	-	-	-
P5	PMXxx ..6 ..8 -EB45	0,10 -0,20	0,10 -0,30	0,20 -0,70	0,30 -1,00	0,40 -1,20	20 (10-25)	50 (30-80)	60 (30-120)	-	120 (80-150)	180 (90-200)	-	-	-	-	-
P6	PMXxx ..6 ..8 -EB45	0,10 -0,20	0,10 -0,30	0,20 -0,70	0,30 -1,00	0,40 -1,20	20 (10-25)	50 (30-80)	60 (30-120)	-	120 (80-150)	180 (90-200)	-	-	-	-	-
P7	PMXxx ..6 ..8 -EB45	0,10 -0,20	0,10 -0,30	0,20 -0,70	0,30 -1,00	0,40 -1,20	20 (10-25)	50 (30-80)	60 (30-120)	-	120 (80-150)	180 (90-200)	-	-	-	-	-
P8	PMXxx ..6 ..8 -EB45	0,10 -0,20	0,10 -0,30	0,20 -0,70	0,30 -1,00	0,40 -1,20	15 (10-20)	35 (20-60)	40 (20-80)	-	80 (60-120)	120 (80-180)	-	-	-	-	-
P11	PMXxx ..6 ..8 -EB45	0,10 -0,20	0,10 -0,30	0,20 -0,70	0,30 -1,00	0,40 -1,20	15 (10-20)	35 (20-60)	40 (20-80)	-	80 (60-120)	120 (80-180)	-	-	-	-	-
P12	PMXxx ..6 ..8 -EB45	0,10 -0,20	0,10 -0,30	0,20 -0,70	0,30 -1,00	0,40 -1,20	12 (8-15)	25 (15-45)	30 (15-65)	-	65 (45-95)	95 (65-145)	-	-	-	-	-
M1	PMXxx ..6 ..8 -EB45	0,08 -0,15	0,10 -0,20	0,20 -0,60	0,30 -0,80	0,40 -1,00	12 (9-15)	25 (15-45)	35 (20-70)	-	-	-	-	25 (15-40)	40 (25-80)	-	-
M2	PMXxx ..6 ..8 -EB45	0,08 -0,15	0,10 -0,20	0,20 -0,60	0,30 -0,80	0,40 -1,00	-	25 (15-45)	35 (20-70)	-	-	-	-	25 (15-40)	40 (25-80)	-	-
M3	PMXxx ..6 ..8 -EB45	0,08 -0,15	0,10 -0,20	0,20 -0,60	0,30 -0,80	0,40 -1,00	-	25 (15-45)	35 (20-70)	-	-	-	-	25 (15-40)	40 (25-80)	-	-
M4	PMXxx ..6 ..8 -EB45	0,08 -0,15	0,10 -0,20	0,20 -0,60	0,30 -0,80	0,40 -1,00	-	20 (10-30)	25 (15-50)	-	-	-	-	20 (10-30)	30 (20-60)	-	-
M5	PMXxx ..6 ..8 -EB45	0,08 -0,15	0,10 -0,20	0,20 -0,60	0,30 -0,80	0,40 -1,00	-	20 (10-30)	25 (15-50)	-	-	-	-	20 (10-30)	30 (20-60)	-	-
K1	PMXxx ..6 ..8 -EB45	0,10 -0,20	0,10 -0,25	0,30 -0,90	0,40 -1,20	0,50 -1,50	25 (15-30)	60 (40-100)	80 (30-150)	90 (35-170)	-	220 (120-300)	245 (135-335)	-	-	-	-
K2	PMXxx ..6 ..8 -EB45	0,10 -0,20	0,10 -0,25	0,30 -0,90	0,40 -1,20	0,50 -1,50	-	25 (20-40)	40 (30-70)	45 (35-80)	-	80 (50-100)	90 (55-110)	-	-	-	-
K3	PMXxx ..6 ..8 -EB45	0,10 -0,20	0,10 -0,25	0,30 -0,90	0,40 -1,20	0,50 -1,50	25 (15-30)	60 (40-100)	80 (30-150)	90 (35-170)	-	220 (120-300)	245 (135-335)	-	-	-	-
K4	PMXxx ..6 ..8 -EB45	0,10 -0,20	0,10 -0,25	0,30 -0,90	0,40 -1,20	0,50 -1,50	25 (15-30)	45 (30-70)	70 (40-120)	80 (45-135)	100 (70-150)	150 (80-200)	170 (90-225)	-	-	-	-
K5	PMXxx ..6 ..8 -EB45	0,10 -0,20	0,10 -0,25	0,30 -0,90	0,40 -1,20	0,50 -1,50	25 (15-30)	45 (30-70)	70 (40-120)	80 (45-135)	100 (70-150)	150 (80-200)	170 (90-225)	-	-	-	-
K6	PMXxx ..6 ..8 -EB45	0,10 -0,20	0,10 -0,25	0,30 -0,90	0,40 -1,20	0,50 -1,50	-	60 (40-100)	80 (30-150)	90 (35-170)	-	220 (120-300)	245 (135-335)	-	-	-	-
K7	PMXxx ..6 ..8 -EB45	0,10 -0,20	0,10 -0,25	0,30 -0,90	0,40 -1,20	0,50 -1,50	-	60 (40-100)	80 (30-150)	90 (35-170)	-	220 (120-300)	245 (135-335)	-	-	-	-
N1	PMXxx ..6 ..8 -EB45	0,10 -0,20	0,10 -0,30	0,30 -0,90	0,40 -1,20	0,50 -1,50	50 (30-100)	-	80 (30-150)	-	-	-	-	50 (30-100)	-	-	-
N2	PMXxx ..6 ..8 -EB45	0,10 -0,20	0,10 -0,30	0,30 -0,90	0,40 -1,20	0,50 -1,50	50 (30-100)	-	80 (30-150)	-	-	-	-	50 (30-100)	-	-	-
N3	PMXxx ..6 ..8 -EB45	0,10 -0,20	0,10 -0,30	0,30 -0,90	0,40 -1,20	0,50 -1,50	50 (30-100)	-	80 (30-150)	-	-	-	-	50 (30-100)	-	-	-
N11	PMXxx ..6 ..8 -EB45	0,10 -0,20	0,10 -0,30	0,30 -0,90	0,40 -1,20	0,50 -1,50	50 (30-100)	-	80 (30-150)	-	-	-	-	50 (30-100)	-	-	-
S1	PMXxx ..6 ..8 -EB45	0,08 -0,15	0,10 -0,15	0,20 -0,60	0,30 -0,80	0,40 -1,00	-	20 (10-25)	20 (10-25)	-	-	-	-	-	-	-	25 (12-30)
S2	PMXxx ..6 ..8 -EB45	0,08 -0,15	0,10 -0,15	0,20 -0,60	0,30 -0,80	0,40 -1,00	-	20 (10-25)	20 (10-25)	-	-	-	-	-	-	-	25 (12-30)
S3	PMXxx ..6 ..8 -EB45	0,08 -0,15	0,10 -0,15	0,20 -0,60	0,30 -0,80	0,40 -1,00	-	20 (10-25)	20 (10-25)	-	-	-	-	-	-	-	25 (12-30)
S11	PMXxx ..6 ..8 -EB45	0,08 -0,15	0,10 -0,15	0,20 -0,60	0,30 -0,80	0,40 -1,00	20 (15-30)	30 (15-40)	40 (20-50)	-	-	-	-	-	-	-	50 (25-65)
S12	PMXxx ..6 ..8 -EB45	0,08 -0,15	0,10 -0,15	0,20 -0,60	0,30 -0,80	0,40 -1,00	20 (15-30)	30 (15-40)	40 (20-50)	-	-	-	-	-	-	-	50 (25-65)
S13	PMXxx ..6 ..8 -EB45	0,08 -0,15	0,10 -0,15	0,20 -0,60	0,30 -0,80	0,40 -1,00	20 (15-30)	30 (15-40)	40 (20-50)	-	-	-	-	-	-	-	50 (25-65)

Tabela jest kontynuowana na następnej stronie.

Wstęp

Wiercenie

Rozwiercanie

Wylaczanie

Zalacznik

Parametry skrawania – PM Plus... -EB45 Metryczne

SMG		a _p (°)		f			v _c										
		z=6	z=8 z=10	z=6	z=8	z=10	H15	CP20	RX2000	RK2050	CF	RX1500	RK1550	RN2010	RM2020	RM2090	RS2090
H3	PMXxx .6 .8 -EB45	0,08 -0,15	0,10 -0,15	0,20 -0,40	0,30 -0,60	0,40 -0,75	-	-	10 (8-15)	-	-	-	-	-	-	-	-
H5	PMXxx .6 .8 -EB45	0,08 -0,15	0,10 -0,15	0,20 -0,40	0,30 -0,60	0,40 -0,75	-	-	10 (8-15)	-	-	-	-	-	-	-	-
H7	PMXxx .6 .8 -EB45	0,08 -0,15	0,10 -0,15	0,20 -0,40	0,30 -0,60	0,40 -0,75	-	-	10 (8-15)	-	-	-	-	-	-	-	-
H8	PMXxx .6 .8 -EB45	0,08 -0,15	0,10 -0,15	0,20 -0,40	0,30 -0,60	0,40 -0,75	-	-	10 (8-15)	-	-	-	-	-	-	-	-
H11	PMXxx .6 .8 -EB45	0,08 -0,15	0,10 -0,15	0,20 -0,40	0,30 -0,60	0,40 -0,75	-	-	10 (8-15)	-	-	-	-	-	-	-	-
H12	PMXxx .6 .8 -EB45	0,08 -0,15	0,10 -0,15	0,20 -0,40	0,30 -0,60	0,40 -0,75	-	-	10 (8-15)	-	-	-	-	-	-	-	-
H21	PMXxx .6 .8 -EB45	0,08 -0,15	0,10 -0,15	0,20 -0,40	0,30 -0,60	0,40 -0,75	-	-	10 (8-15)	-	-	-	-	-	-	-	-
H31	PMXxx .6 .8 -EB45	0,08 -0,15	0,10 -0,15	0,20 -0,40	0,30 -0,60	0,40 -0,75	-	-	10 (8-15)	-	-	-	-	-	-	-	-
PM1	PMXxx .6 .8 -EB45	0,10- 0,20	0,10 -0,30	0,30 -0,90	0,40 -1,20	0,50 -1,50	-	50 (30-80)	70 (40-100)	-	-	-	-	-	-	-	-
PM2	PMXxx .6 .8 -EB45	0,10- 0,20	0,10 -0,30	0,30 -0,90	0,40 -1,20	0,50 -1,50	-	50 (30-80)	70 (40-100)	-	-	-	-	-	-	-	-
PM3	PMXxx .6 .8 -EB45	0,10- 0,20	0,10 -0,30	0,30 -0,90	0,40 -1,20	0,50 -1,50	-	50 (30-80)	70 (40-100)	-	-	-	-	-	-	-	-
TS1	PMXxx .6 .8 -EB45	0,10 -0,15	0,10 -0,20	0,30 -0,90	0,40 -1,20	0,50 -1,50	20 (15-25)	-	40 (20-60)	-	-	-	-	-	-	-	-
TS2	PMXxx .6 .8 -EB45	0,10 -0,15	0,10 -0,20	0,30 -0,90	0,40 -1,20	0,50 -1,50	20 (15-25)	-	40 (20-60)	-	-	-	-	-	-	-	-
TS3	PMXxx .6 .8 -EB45	0,10 -0,15	0,10 -0,20	0,30 -0,90	0,40 -1,20	0,50 -1,50	20 (15-25)	-	40 (20-60)	-	-	-	-	-	-	-	-
TS4	PMXxx .6 .8 -EB45	0,10 -0,15	0,10 -0,20	0,30 -0,90	0,40 -1,20	0,50 -1,50	20 (15-25)	-	40 (20-60)	-	-	-	-	-	-	-	-
TP1	PMXxx .6 .8 -EB45	0,10 -0,15	0,10 -0,20	0,30 -0,90	0,40 -1,20	0,50 -1,50	20 (15-25)	-	40 (20-60)	-	-	-	-	-	-	-	-
TP2	PMXxx .6 .8 -EB45	0,10 -0,15	0,10 -0,20	0,30 -0,90	0,40 -1,20	0,50 -1,50	20 (15-25)	-	40 (20-60)	-	-	-	-	-	-	-	-
TP3	PMXxx .6 .8 -EB45	0,10 -0,15	0,10 -0,20	0,30 -0,90	0,40 -1,20	0,50 -1,50	20 (15-25)	-	40 (20-60)	-	-	-	-	-	-	-	-
TP4	PMXxx .6 .8 -EB45	0,10 -0,15	0,10 -0,20	0,30 -0,90	0,40 -1,20	0,50 -1,50	20 (15-25)	-	40 (20-60)	-	-	-	-	-	-	-	-
GR1	PMXxx .6 .8 -EB45	0,10 -0,30	0,10 -0,40	0,30 -0,90	0,40 -1,20	0,50 -1,50	40 (80-20)	-	60 (30-120)	-	-	-	-	-	-	-	-

SMG = Grupy materiałowe Seco

a_p = mm

f = mm/obr

v_c = m/min

Wszystkie parametry są wartościami początkowymi

Wstęp

Wiercenie

Rozwiercanie

Wyłaczanie

Załącznik

Parametry skrawania – PM Plus...-EB45 cale

SMG		a _p (°)		f			v _c										
		z=6	z=8 z=10	z=6	z=8	z=10	H15	CP20	RX2000	RK2050	CF	RX1500	RK1550	RN2010	RM2020	RM2090	RS2090
P1	PMXxx..6..8-EB45	.004 -0.008	.004 -0.012	.012 -0.035	.016 -0.047	.020 -0.059	80 (50-100)	195 (100-330)	260 (100-490)	-	590 (295-655)	720 (395-985)	-	-	-	-	-
P2	PMXxx..6..8-EB45	.004 -0.008	.004 -0.012	.012 -0.035	.016 -0.047	.020 -0.059	80 (50-100)	195 (100-330)	260 (100-490)	-	590 (295-655)	720 (395-985)	-	-	-	-	-
P3	PMXxx..6..8-EB45	.004 -0.008	.004 -0.012	.012 -0.035	.016 -0.047	.020 -0.059	80 (50-100)	195 (100-330)	260 (100-490)	-	590 (295-655)	720 (395-985)	-	-	-	-	-
P4	PMXxx..6..8-EB45	.004 -0.008	.004 -0.012	.008 -0.028	.012 -0.039	.016 -0.047	65 (35-80)	165 (100-260)	195 (100-395)	-	395 (260-490)	590 (295-655)	-	-	-	-	-
P5	PMXxx..6..8-EB45	.004 -0.008	.004 -0.012	.008 -0.028	.012 -0.039	.016 -0.047	65 (35-80)	165 (100-260)	195 (100-395)	-	395 (260-490)	590 (295-655)	-	-	-	-	-
P6	PMXxx..6..8-EB45	.004 -0.008	.004 -0.012	.008 -0.028	.012 -0.039	.016 -0.047	65 (35-80)	165 (100-260)	195 (100-395)	-	395 (260-490)	590 (295-655)	-	-	-	-	-
P7	PMXxx..6..8-EB45	.004 -0.008	.004 -0.012	.008 -0.028	.012 -0.039	.016 -0.047	65 (35-80)	165 (100-260)	195 (100-395)	-	395 (260-490)	590 (295-655)	-	-	-	-	-
P8	PMXxx..6..8-EB45	.004 -0.008	.004 -0.012	.008 -0.028	.012 -0.039	.016 -0.047	50 (35-65)	115 (65-195)	130 (65-260)	-	260 (195-395)	395 (260-590)	-	-	-	-	-
P11	PMXxx..6..8-EB45	.004 -0.008	.004 -0.012	.008 -0.028	.012 -0.039	.016 -0.047	50 (35-65)	115 (65-195)	130 (65-260)	-	260 (195-395)	395 (260-590)	-	-	-	-	-
P12	PMXxx..6..8-EB45	.004 -0.008	.004 -0.012	.008 -0.028	.012 -0.039	.016 -0.047	40 (25-50)	80 (50-130)	100 (50-215)	-	215 (150-315)	315 (215-480)	-	-	-	-	-
M1	PMXxx..6..8-EB45	.003 -0.006	.004 -0.008	.008 -0.024	.012 -0.031	.016 -0.039	40 (30-50)	80 (50-130)	115 (65-230)	-	-	-	-	80 (50-130)	130 (80-260)	-	-
M2	PMXxx..6..8-EB45	.003 -0.006	.004 -0.008	.008 -0.024	.012 -0.031	.016 -0.039	-	80 (50-130)	115 (65-230)	-	-	-	-	80 (50-130)	130 (80-260)	-	-
M3	PMXxx..6..8-EB45	.003 -0.006	.004 -0.008	.008 -0.024	.012 -0.031	.016 -0.039	-	80 (50-130)	115 (65-230)	-	-	-	-	80 (50-130)	130 (80-260)	-	-
M4	PMXxx..6..8-EB45	.003 -0.006	.004 -0.008	.008 -0.024	.012 -0.031	.016 -0.039	-	65 (35-100)	80 (50-165)	-	-	-	-	65 (35-100)	100 (65-195)	-	-
M5	PMXxx..6..8-EB45	.003 -0.006	.004 -0.008	.008 -0.024	.012 -0.031	.016 -0.039	-	65 (35-100)	80 (50-165)	-	-	-	-	65 (35-100)	100 (65-195)	-	-
K1	PMXxx..6..8-EB45	.004 -0.008	.004 -0.010	.012 -0.035	.016 -0.047	.020 -0.059	80 (50-100)	195 (130-330)	260 (100-490)	290 (110-550)	-	720 (395-985)	805 (440-1105)	-	-	-	-
K2	PMXxx..6..8-EB45	.004 -0.008	.004 -0.010	.012 -0.035	.016 -0.047	.020 -0.059	-	80 (65-130)	130 (100-230)	145 (110-260)	-	260 (165-330)	290 (185-370)	-	-	-	-
K3	PMXxx..6..8-EB45	.004 -0.008	.004 -0.010	.012 -0.035	.016 -0.047	.020 -0.059	80 (50-100)	195 (130-330)	260 (100-490)	290 (110-550)	-	720 (395-985)	805 (440-1105)	-	-	-	-
K4	PMXxx..6..8-EB45	.004 -0.008	.004 -0.010	.012 -0.035	.016 -0.047	.020 -0.059	80 (50-100)	150 (100-230)	230 (130-395)	260 (145-440)	330 (230-490)	490 (260-655)	550 (290-735)	-	-	-	-
K5	PMXxx..6..8-EB45	.004 -0.008	.004 -0.010	.012 -0.035	.016 -0.047	.020 -0.059	80 (50-100)	150 (100-230)	230 (130-395)	260 (145-440)	330 (230-490)	490 (260-655)	550 (290-735)	-	-	-	-
K6	PMXxx..6..8-EB45	.004 -0.008	.004 -0.010	.012 -0.035	.016 -0.047	.020 -0.059	-	195 (130-330)	260 (100-490)	290 (110-550)	-	720 (395-985)	805 (440-1105)	-	-	-	-
K7	PMXxx..6..8-EB45	.004 -0.008	.004 -0.010	.012 -0.035	.016 -0.047	.020 -0.059	-	195 (130-330)	260 (100-490)	290 (110-550)	-	720 (395-985)	805 (440-1105)	-	-	-	-
N1	PMXxx..6..8-EB45	.004 -0.008	.004 -0.012	.012 -0.035	.016 -0.047	.020 -0.059	165 (100-330)	-	260 (100-490)	-	-	-	-	165 (100-330)	-	-	-
N2	PMXxx..6..8-EB45	.004 -0.008	.004 -0.012	.012 -0.035	.016 -0.047	.020 -0.059	165 (100-330)	-	260 (100-490)	-	-	-	-	165 (100-330)	-	-	-
N3	PMXxx..6..8-EB45	.004 -0.008	.004 -0.012	.012 -0.035	.016 -0.047	.020 -0.059	165 (100-330)	-	260 (100-490)	-	-	-	-	165 (100-330)	-	-	-
N11	PMXxx..6..8-EB45	.004 -0.008	.004 -0.012	.012 -0.035	.016 -0.047	.020 -0.059	165 (100-330)	-	260 (100-490)	-	-	-	-	165 (100-330)	-	-	-
S1	PMXxx..6..8-EB45	.003 -0.006	.004 -0.006	.008 -0.024	.012 -0.031	.016 -0.039	-	65 (35-80)	65 (35-80)	-	-	-	-	-	-	-	80 (40-100)
S2	PMXxx..6..8-EB45	.003 -0.006	.004 -0.006	.008 -0.024	.012 -0.031	.016 -0.039	-	65 (35-80)	65 (35-80)	-	-	-	-	-	-	-	80 (40-100)
S3	PMXxx..6..8-EB45	.003 -0.006	.004 -0.006	.008 -0.024	.012 -0.031	.016 -0.039	-	65 (35-80)	65 (35-80)	-	-	-	-	-	-	-	80 (40-100)
S11	PMXxx..6..8-EB45	.003 -0.006	.004 -0.006	.008 -0.024	.012 -0.031	.016 -0.039	65 (50-100)	100 (50-130)	130 (65-165)	-	-	-	-	-	-	-	165 (80-215)
S12	PMXxx..6..8-EB45	.003 -0.006	.004 -0.006	.008 -0.024	.012 -0.031	.016 -0.039	65 (50-100)	100 (50-130)	130 (65-165)	-	-	-	-	-	-	-	165 (80-215)
S13	PMXxx..6..8-EB45	.003 -0.006	.004 -0.006	.008 -0.024	.012 -0.031	.016 -0.039	65 (50-100)	100 (50-130)	130 (65-165)	-	-	-	-	-	-	-	165 (80-215)

Tabela jest kontynuowana na następnej stronie.

Wstęp

Wfrczenie

Rozwiercanie

Wylaczenie

Zalacznik

Parametry skrawania – PM Plus...-EB45 cale

SMG		a _p (°)		f			v _c										
		z=6	z=8 z=10	z=6	z=8	z=10	H15	CP20	RX2000	RK2050	CF	RX1500	RK1550	RN2010	RM2020	RM2090	RS2090
H5	PMXxx .6..8 -EB45	.003 -.006	.004 -.006	.008 -.016	.012 -.024	.016 -.030	-	-	35 (25-50)	-	-	-	-	-	-	-	-
H7	PMXxx .6..8 -EB45	.003 -.006	.004 -.006	.008 -.016	.012 -.024	.016 -.030	-	-	35 (25-50)	-	-	-	-	-	-	-	-
H8	PMXxx .6..8 -EB45	.003 -.006	.004 -.006	.008 -.016	.012 -.024	.016 -.030	-	-	35 (25-50)	-	-	-	-	-	-	-	-
H11	PMXxx .6..8 -EB45	.003 -.006	.004 -.006	.008 -.016	.012 -.024	.016 -.030	-	-	35 (25-50)	-	-	-	-	-	-	-	-
H12	PMXxx .6..8 -EB45	.003 -.006	.004 -.006	.008 -.016	.012 -.024	.016 -.030	-	-	35 (25-50)	-	-	-	-	-	-	-	-
H21	PMXxx .6..8 -EB45	.003 -.006	.004 -.006	.008 -.016	.012 -.024	.016 -.030	-	-	35 (25-50)	-	-	-	-	-	-	-	-
H31	PMXxx .6..8 -EB45	.003 -.006	.004 -.006	.008 -.016	.012 -.024	.016 -.030	-	-	35 (25-50)	-	-	-	-	-	-	-	-
PM1	PMXxx .6..8 -EB45	.004 -.008	.004 -.012	.012 -.035	.016 -.047	.020 -.059	-	165 (100-260)	230 (130-330)	-	-	-	-	-	-	-	-
PM2	PMXxx .6..8 -EB45	.004 -.008	.004 -.012	.012 -.035	.016 -.047	.020 -.059	-	165 (100-260)	230 (130-330)	-	-	-	-	-	-	-	-
PM3	PMXxx .6..8 -EB45	.004 -.008	.004 -.012	.012 -.035	.016 -.047	.020 -.059	-	165 (100-260)	230 (130-330)	-	-	-	-	-	-	-	-
TS1	PMXxx .6..8 -EB45	.004 -.006	.004 -.008	.012 -.035	.016 -.047	.020 -.059	65 (50-80)	-	130 (65-195)	-	-	-	-	-	-	-	-
TS2	PMXxx .6..8 -EB45	.004 -.006	.004 -.008	.012 -.035	.016 -.047	.020 -.059	65 (50-80)	-	130 (65-195)	-	-	-	-	-	-	-	-
TS3	PMXxx .6..8 -EB45	.004 -.006	.004 -.008	.012 -.035	.016 -.047	.020 -.059	65 (50-80)	-	130 (65-195)	-	-	-	-	-	-	-	-
TS4	PMXxx .6..8 -EB45	.004 -.006	.004 -.008	.012 -.035	.016 -.047	.020 -.059	65 (50-80)	-	130 (65-195)	-	-	-	-	-	-	-	-
TP1	PMXxx .6..8 -EB45	.004 -.006	.004 -.008	.012 -.035	.016 -.047	.020 -.059	65 (50-80)	-	130 (65-195)	-	-	-	-	-	-	-	-
TP2	PMXxx .6..8 -EB45	.004 -.006	.004 -.008	.012 -.035	.016 -.047	.020 -.059	65 (50-80)	-	130 (65-195)	-	-	-	-	-	-	-	-
TP3	PMXxx .6..8 -EB45	.004 -.006	.004 -.008	.012 -.035	.016 -.047	.020 -.059	65 (50-80)	-	130 (65-195)	-	-	-	-	-	-	-	-
TP4	PMXxx .6..8 -EB45	.004 -.006	.004 -.008	.012 -.035	.016 -.047	.020 -.059	65 (50-80)	-	130 (65-195)	-	-	-	-	-	-	-	-
GR1	PMXxx .6..8 -EB45	.004 -.012	.004 -.016	.012 -.035	.016 -.047	.020 -.059	65 (50-80)	-	130 (65-195)	-	-	-	-	-	-	-	-

SMG = Grupy materiałowe Seco
 a_p = calowe
 f = cal/obr.
 v_c = stp/min
 Wszystkie parametry są wartościami początkowymi

Wstęp

Wiercenie

Rozwiercanie

Wyłaczanie

Załącznik

Parametry skrawania – PM Plus...-EB845 Metryczne

SMG		a _p (°)		f			v _c									
		z=6	z=8 z=10	z=6	z=8	z=10	H15	CP20	RX2000	RK2050	CF	RX1500	RK1550	RM2020	RM2090	RS2090
P3	PMXxx .6 .8 -EB845	0,10 -0,20	0,10 -0,30	0,30 -0,90	0,40 -1,20	0,50 -1,50	25 (15-30)	60 (30-100)	80 (30-150)	-	180 (90-200)	220 (120-300)	-	-	-	-
P4	PMXxx .6 .8 -EB845	0,10 -0,20	0,10 -0,30	0,20 -0,70	0,30 -1,00	0,40 -1,20	20 (10-25)	50 (30-80)	60 (30-120)	-	120 (80-150)	180 (90-200)	-	-	-	-
P5	PMXxx .6 .8 -EB845	0,10 -0,20	0,10 -0,30	0,20 -0,70	0,30 -1,00	0,40 -1,20	20 (10-25)	50 (30-80)	60 (30-120)	-	120 (80-150)	180 (90-200)	-	-	-	-
P6	PMXxx .6 .8 -EB845	0,10 -0,20	0,10 -0,30	0,20 -0,70	0,30 -1,00	0,40 -1,20	20 (10-25)	50 (30-80)	60 (30-120)	-	120 (80-150)	180 (90-200)	-	-	-	-
P7	PMXxx .6 .8 -EB845	0,10 -0,20	0,10 -0,30	0,20 -0,70	0,30 -1,00	0,40 -1,20	20 (10-25)	50 (30-80)	60 (30-120)	-	120 (80-150)	180 (90-200)	-	-	-	-
P8	PMXxx .6 .8 -EB845	0,10 -0,20	0,10 -0,30	0,20 -0,70	0,30 -1,00	0,40 -1,20	15 (10-20)	35 (20-60)	40 (20-80)	-	80 (60-120)	120 (80-180)	-	-	-	-
P11	PMXxx .6 .8 -EB845	0,10 -0,20	0,10 -0,30	0,20 -0,70	0,30 -1,00	0,40 -1,20	15 (10-20)	35 (20-60)	40 (20-80)	-	80 (60-120)	120 (80-180)	-	-	-	-
P12	PMXxx .6 .8 -EB845	0,10 -0,20	0,10 -0,30	0,20 -0,70	0,30 -1,00	0,40 -1,20	12 (8-15)	25 (15-45)	30 (15-65)	-	65 (45-95)	95 (65-145)	-	-	-	-
M1	PMXxx .6 .8 -EB845	0,08 -0,15	0,10 -0,20	0,20 -0,60	0,30 -0,80	0,40 -1,00	12 (9-15)	25 (15-45)	35 (20-70)	-	-	-	-	25 (15-40)	35 (20-70)	-
M2	PMXxx .6 .8 -EB845	0,08 -0,15	0,10 -0,20	0,20 -0,60	0,30 -0,80	0,40 -1,00	-	25 (15-45)	35 (20-70)	-	-	-	-	25 (15-40)	35 (20-70)	-
M3	PMXxx .6 .8 -EB845	0,08 -0,15	0,10 -0,20	0,20 -0,60	0,30 -0,80	0,40 -1,00	-	25 (15-45)	35 (20-70)	-	-	-	-	25 (15-40)	35 (20-70)	-
M4	PMXxx .6 .8 -EB845	0,08 -0,15	0,10 -0,20	0,20 -0,60	0,30 -0,80	0,40 -1,00	-	20 (10-30)	25 (15-50)	-	-	-	-	20 (10-30)	25 (15-50)	-
M5	PMXxx .6 .8 -EB845	0,08 -0,15	0,10 -0,20	0,20 -0,60	0,30 -0,80	0,40 -1,00	-	20 (10-30)	25 (15-50)	-	-	-	-	20 (10-30)	25 (15-50)	-
K1	PMXxx .6 .8 -EB845	0,10 -0,20	0,10 -0,25	0,30 -0,90	0,40 -1,20	0,50 -1,50	25 (15-30)	60 (40-100)	80 (30-150)	90 (35-170)	-	220 (120-300)	245 (135-335)	-	-	-
K2	PMXxx .6 .8 -EB845	0,10 -0,20	0,10 -0,25	0,30 -0,90	0,40 -1,20	0,50 -1,50	-	25 (20-40)	40 (30-70)	45 (35-80)	-	80 (50-100)	90 (55-110)	-	-	-
K3	PMXxx .6 .8 -EB845	0,10 -0,20	0,10 -0,25	0,30 -0,90	0,40 -1,20	0,50 -1,50	25 (15-30)	60 (40-100)	80 (30-150)	90 (35-170)	-	220 (120-300)	245 (135-335)	-	-	-
K4	PMXxx .6 .8 -EB845	0,10 -0,20	0,10 -0,25	0,30 -0,90	0,40 -1,20	0,50 -1,50	25 (15-30)	45 (30-70)	70 (40-120)	80 (45-135)	100 (70-150)	150 (80-200)	170 (90-225)	-	-	-
K5	PMXxx .6 .8 -EB845	0,10 -0,20	0,10 -0,25	0,30 -0,90	0,40 -1,20	0,50 -1,50	25 (15-30)	45 (30-70)	70 (40-120)	80 (45-135)	100 (70-150)	150 (80-200)	170 (90-225)	-	-	-
K6	PMXxx .6 .8 -EB845	0,10 -0,20	0,10 -0,25	0,30 -0,90	0,40 -1,20	0,50 -1,50	-	60 (40-100)	80 (30-150)	90 (35-170)	-	220 (120-300)	245 (135-335)	-	-	-
K7	PMXxx .6 .8 -EB845	0,10 -0,20	0,10 -0,25	0,30 -0,90	0,40 -1,20	0,50 -1,50	-	60 (40-100)	80 (30-150)	90 (35-170)	-	220 (120-300)	245 (135-335)	-	-	-
S1	PMXxx .6 .8 -EB845	0,08 -0,15	0,10 -0,15	0,20 -0,60	0,30 -0,80	0,40 -1,00	-	20 (10-25)	20 (10-25)	-	-	-	-	-	-	25 (12-30)
S2	PMXxx .6 .8 -EB845	0,08 -0,15	0,10 -0,15	0,20 -0,60	0,30 -0,80	0,40 -1,00	-	20 (10-25)	20 (10-25)	-	-	-	-	-	-	25 (12-30)
S3	PMXxx .6 .8 -EB845	0,08 -0,15	0,10 -0,15	0,20 -0,60	0,30 -0,80	0,40 -1,00	-	20 (10-25)	20 (10-25)	-	-	-	-	-	-	25 (12-30)
S11	PMXxx .6 .8 -EB845	0,08 -0,15	0,10 -0,15	0,20 -0,60	0,30 -0,80	0,40 -1,00	20 (15-30)	30 (15-40)	40 (20-50)	-	-	-	-	-	-	50 (25-65)
S12	PMXxx .6 .8 -EB845	0,08 -0,15	0,10 -0,15	0,20 -0,60	0,30 -0,80	0,40 -1,00	20 (15-30)	30 (15-40)	40 (20-50)	-	-	-	-	-	-	50 (25-65)
S13	PMXxx .6 .8 -EB845	0,08 -0,15	0,10 -0,15	0,20 -0,60	0,30 -0,80	0,40 -1,00	20 (15-30)	30 (15-40)	40 (20-50)	-	-	-	-	-	-	50 (25-65)
H3	PMXxx .6 .8 -EB845	0,08 -0,15	0,10 -0,15	0,20 -0,40	0,30 -0,60	0,40 -0,75	-	-	10 (8-15)	-	-	-	-	-	-	-
H5	PMXxx .6 .8 -EB845	0,08 -0,15	0,10 -0,15	0,20 -0,40	0,30 -0,60	0,40 -0,75	-	-	10 (8-15)	-	-	-	-	-	-	-
H7	PMXxx .6 .8 -EB845	0,08 -0,15	0,10 -0,15	0,20 -0,40	0,30 -0,60	0,40 -0,75	-	-	10 (8-15)	-	-	-	-	-	-	-
H8	PMXxx .6 .8 -EB845	0,08 -0,15	0,10 -0,15	0,20 -0,40	0,30 -0,60	0,40 -0,75	-	-	10 (8-15)	-	-	-	-	-	-	-
H11	PMXxx .6 .8 -EB845	0,08 -0,15	0,10 -0,15	0,20 -0,40	0,30 -0,60	0,40 -0,75	-	-	10 (8-15)	-	-	-	-	-	-	-
H12	PMXxx .6 .8 -EB845	0,08 -0,15	0,10 -0,15	0,20 -0,40	0,30 -0,60	0,40 -0,75	-	-	10 (8-15)	-	-	-	-	-	-	-
H21	PMXxx .6 .8 -EB845	0,08 -0,15	0,10 -0,15	0,20 -0,40	0,30 -0,60	0,40 -0,75	-	-	10 (8-15)	-	-	-	-	-	-	-
H31	PMXxx .6 .8 -EB845	0,08 -0,15	0,10 -0,15	0,20 -0,40	0,30 -0,60	0,40 -0,75	-	-	10 (8-15)	-	-	-	-	-	-	-
PM1	PMXxx .6 .8 -EB845	0,10- 0,20	0,10 -0,30	0,30 -0,90	0,40 -1,20	0,50 -1,50	-	50 (30-80)	70 (40-100)	-	-	-	-	-	-	-
PM2	PMXxx .6 .8 -EB845	0,10- 0,20	0,10 -0,30	0,30 -0,90	0,40 -1,20	0,50 -1,50	-	50 (30-80)	70 (40-100)	-	-	-	-	-	-	-
PM3	PMXxx .6 .8 -EB845	0,10- 0,20	0,10 -0,30	0,30 -0,90	0,40 -1,20	0,50 -1,50	-	50 (30-80)	70 (40-100)	-	-	-	-	-	-	-

SMG = Grupy materiałowe Seco

a_p = mm

f = mm/obr

v_c = m/min

Wszystkie parametry są wartościami początkowymi

Wstęp

Wiercenie

Rozwiercanie

Wylaczanie

Zalacznik

Parametry skrawania – PM Plus...-EB845 cale

SMG		a _p (°)		f			v _c									
		z=6	z=8 z=10	z=6	z=8	z=10	H15	CP20	RX2000	RK2050	CF	RX1500	RK1550	RM2020	RM2090	RS2090
P3	PMXxx..6..8-EB45	.004 -.008	.004 -.012	.012 -.035	.016 -.047	.020 -.059	80 (50-100)	195 (100-330)	260 (100-490)	-	590 (295-655)	720 (395-985)	-	-	-	-
P4	PMXxx..6..8-EB45	.004 -.008	.004 -.012	.008 -.028	.012 -.039	.016 -.047	65 (35-80)	165 (100-260)	195 (100-395)	-	395 (260-490)	590 (295-655)	-	-	-	-
P5	PMXxx..6..8-EB45	.004 -.008	.004 -.012	.008 -.028	.012 -.039	.016 -.047	65 (35-80)	165 (100-260)	195 (100-395)	-	395 (260-490)	590 (295-655)	-	-	-	-
P6	PMXxx..6..8-EB45	.004 -.008	.004 -.012	.008 -.028	.012 -.039	.016 -.047	65 (35-80)	165 (100-260)	195 (100-395)	-	395 (260-490)	590 (295-655)	-	-	-	-
P7	PMXxx..6..8-EB45	.004 -.008	.004 -.012	.008 -.028	.012 -.039	.016 -.047	65 (35-80)	165 (100-260)	195 (100-395)	-	395 (260-490)	590 (295-655)	-	-	-	-
P8	PMXxx..6..8-EB45	.004 -.008	.004 -.012	.008 -.028	.012 -.039	.016 -.047	50 (35-65)	115 (65-195)	130 (65-260)	-	260 (195-395)	395 (260-590)	-	-	-	-
P11	PMXxx..6..8-EB45	.004 -.008	.004 -.012	.008 -.028	.012 -.039	.016 -.047	50 (35-65)	115 (65-195)	130 (65-260)	-	260 (195-395)	395 (260-590)	-	-	-	-
P12	PMXxx..6..8-EB45	.004 -.008	.004 -.012	.008 -.028	.012 -.039	.016 -.047	40 (25-50)	80 (50-130)	100 (50-215)	-	215 (150-315)	315 (215-480)	-	-	-	-
M1	PMXxx..6..8-EB45	.003 -.006	.004 -.008	.008 -.024	.012 -.031	.016 -.039	40 (30-50)	80 (50-130)	115 (65-230)	-	-	-	-	80 (50-130)	115 (65-230)	-
M2	PMXxx..6..8-EB45	.003 -.006	.004 -.008	.008 -.024	.012 -.031	.016 -.039	-	80 (50-130)	115 (65-230)	-	-	-	-	80 (50-130)	115 (65-230)	-
M3	PMXxx..6..8-EB45	.003 -.006	.004 -.008	.008 -.024	.012 -.031	.016 -.039	-	80 (50-130)	115 (65-230)	-	-	-	-	80 (50-130)	115 (65-230)	-
M4	PMXxx..6..8-EB45	.003 -.006	.004 -.008	.008 -.024	.012 -.031	.016 -.039	-	65 (35-100)	80 (50-165)	-	-	-	-	65 (35-100)	80 (50-165)	-
M5	PMXxx..6..8-EB45	.003 -.006	.004 -.008	.008 -.024	.012 -.031	.016 -.039	-	65 (35-100)	80 (50-165)	-	-	-	-	65 (35-100)	80 (50-165)	-
K1	PMXxx..6..8-EB45	.004 -.008	.004 -.010	.012 -.035	.016 -.047	.020 -.059	80 (50-100)	195 (130-330)	260 (100-490)	290 (110-550)	-	720 (395-985)	805 (440-1105)	-	-	-
K2	PMXxx..6..8-EB45	.004 -.008	.004 -.010	.012 -.035	.016 -.047	.020 -.059	-	80 (65-130)	130 (100-230)	145 (110-260)	-	260 (165-330)	290 (185-370)	-	-	-
K3	PMXxx..6..8-EB45	.004 -.008	.004 -.010	.012 -.035	.016 -.047	.020 -.059	80 (50-100)	195 (130-330)	260 (100-490)	290 (110-550)	-	720 (395-985)	805 (440-1105)	-	-	-
K4	PMXxx..6..8-EB45	.004 -.008	.004 -.010	.012 -.035	.016 -.047	.020 -.059	80 (50-100)	150 (100-230)	230 (130-395)	260 (145-440)	330 (230-490)	490 (260-655)	550 (290-735)	-	-	-
K5	PMXxx..6..8-EB45	.004 -.008	.004 -.010	.012 -.035	.016 -.047	.020 -.059	80 (50-100)	150 (100-230)	230 (130-395)	260 (145-440)	330 (230-490)	490 (260-655)	550 (290-735)	-	-	-
K6	PMXxx..6..8-EB45	.004 -.008	.004 -.010	.012 -.035	.016 -.047	.020 -.059	-	195 (130-330)	260 (100-490)	290 (110-550)	-	720 (395-985)	805 (440-1105)	-	-	-
K7	PMXxx..6..8-EB45	.004 -.008	.004 -.010	.012 -.035	.016 -.047	.020 -.059	-	195 (130-330)	260 (100-490)	290 (110-550)	-	720 (395-985)	805 (440-1105)	-	-	-
S1	PMXxx..6..8-EB45	.003 -.006	.004 -.006	.008 -.024	.012 -.031	.016 -.039	-	65 (35-80)	65 (35-80)	-	-	-	-	-	-	80 (40-100)
S2	PMXxx..6..8-EB45	.003 -.006	.004 -.006	.008 -.024	.012 -.031	.016 -.039	-	65 (35-80)	65 (35-80)	-	-	-	-	-	-	80 (40-100)
S3	PMXxx..6..8-EB45	.003 -.006	.004 -.006	.008 -.024	.012 -.031	.016 -.039	-	65 (35-80)	65 (35-80)	-	-	-	-	-	-	80 (40-100)
S11	PMXxx..6..8-EB45	.003 -.006	.004 -.006	.008 -.024	.012 -.031	.016 -.039	65 (50-100)	100 (50-130)	130 (65-165)	-	-	-	-	-	-	165 (80-215)
S12	PMXxx..6..8-EB45	.003 -.006	.004 -.006	.008 -.024	.012 -.031	.016 -.039	65 (50-100)	100 (50-130)	130 (65-165)	-	-	-	-	-	-	165 (80-215)
S13	PMXxx..6..8-EB45	.003 -.006	.004 -.006	.008 -.024	.012 -.031	.016 -.039	65 (50-100)	100 (50-130)	130 (65-165)	-	-	-	-	-	-	165 (80-215)
H3	PMXxx..6..8-EB45	.003 -.006	.004 -.006	.008 -.016	.012 -.024	.016 -.030	-	-	35 (25-50)	-	-	-	-	-	-	-
H5	PMXxx..6..8-EB45	.003 -.006	.004 -.006	.008 -.016	.012 -.024	.016 -.030	-	-	35 (25-50)	-	-	-	-	-	-	-
H7	PMXxx..6..8-EB45	.003 -.006	.004 -.006	.008 -.016	.012 -.024	.016 -.030	-	-	35 (25-50)	-	-	-	-	-	-	-
H8	PMXxx..6..8-EB45	.003 -.006	.004 -.006	.008 -.016	.012 -.024	.016 -.030	-	-	35 (25-50)	-	-	-	-	-	-	-
H11	PMXxx..6..8-EB45	.003 -.006	.004 -.006	.008 -.016	.012 -.024	.016 -.030	-	-	35 (25-50)	-	-	-	-	-	-	-
H12	PMXxx..6..8-EB45	.003 -.006	.004 -.006	.008 -.016	.012 -.024	.016 -.030	-	-	35 (25-50)	-	-	-	-	-	-	-
H21	PMXxx..6..8-EB45	.003 -.006	.004 -.006	.008 -.016	.012 -.024	.016 -.030	-	-	35 (25-50)	-	-	-	-	-	-	-
H31	PMXxx..6..8-EB45	.003 -.006	.004 -.006	.008 -.016	.012 -.024	.016 -.030	-	-	35 (25-50)	-	-	-	-	-	-	-
PM1	PMXxx..6..8-EB45	.004 -.008	.004 -.012	.012 -.035	.016 -.047	.020 -.059	-	165 (100-260)	230 (130-330)	-	-	-	-	-	-	-
PM2	PMXxx..6..8-EB45	.004 -.008	.004 -.012	.012 -.035	.016 -.047	.020 -.059	-	165 (100-260)	230 (130-330)	-	-	-	-	-	-	-
PM3	PMXxx..6..8-EB45	.004 -.008	.004 -.012	.012 -.035	.016 -.047	.020 -.059	-	165 (100-260)	230 (130-330)	-	-	-	-	-	-	-

SMG = Grupy materiałowe Seco

a_p = calowe

f = cal/obr.

v_c = stp/min

Wszystkie parametry są wartościami początkowymi

Wstęp

Wiercenie

Rozwiercanie

Wytaczanie

Zalążnik

Parametry skrawania – Plus... -EB25/EB30 Metryczne

SMG		a_p (°)		f			v_c						
		z=6	z=8 z=10	z=6	z=8	z=10	H15	CP20	RX2000	RK2050	CF	RX1500	RK1550
P1	PMXxx .6 .8 -EB25/EB30	0,10-0,20	0,10-0,30	0,80-1,80	1,00-2,40	1,20-3,00	25 (15-30)	60 (30-100)	80 (30-150)	-	180 (90-200)	220 (120-300)	-
P2	PMXxx .6 .8 -EB25/EB30	0,10-0,20	0,10-0,30	0,80-1,80	1,00-2,40	1,20-3,00	25 (15-30)	60 (30-100)	80 (30-150)	-	180 (90-200)	220 (120-300)	-
P3	PMXxx .6 .8 -EB25/EB30	0,10-0,20	0,10-0,30	0,80-1,80	1,00-2,40	1,20-3,00	25 (15-30)	60 (30-100)	80 (30-150)	-	180 (90-200)	220 (120-300)	-
P4	PMXxx .6 .8 -EB25/EB30	0,10-0,20	0,10-0,30	0,80-1,80	1,00-2,40	1,20-3,00	20 (10-25)	50 (30-80)	60 (30-120)	-	120 (80-150)	180 (90-200)	-
P5	PMXxx .6 .8 -EB25/EB30	0,10-0,20	0,10-0,30	0,80-1,80	1,00-2,40	1,20-3,00	20 (10-25)	50 (30-80)	60 (30-120)	-	120 (80-150)	180 (90-200)	-
P6	PMXxx .6 .8 -EB25/EB30	0,10-0,20	0,10-0,30	0,80-1,80	1,00-2,40	1,20-3,00	20 (10-25)	50 (30-80)	60 (30-120)	-	120 (80-150)	180 (90-200)	-
P7	PMXxx .6 .8 -EB25/EB30	0,10-0,20	0,10-0,30	0,80-1,80	1,00-2,40	1,20-3,00	20 (10-25)	50 (30-80)	60 (30-120)	-	120 (80-150)	180 (90-200)	-
M1	PMXxx .6 .8 -EB25/EB30	0,08-0,15	0,10-0,20	0,80-1,20	1,00-2,00	1,20-2,50	-	25 (15-40)	35 (20-70)	-	-	-	-
K1	PMXxx .6 .8 -EB25/EB30	0,10-0,20	0,10-0,25	0,80-2,20	1,00-2,80	1,20-3,50	25 (15-30)	60 (40-100)	80 (30-150)	90 (35-170)	-	220 (120-300)	245 (135-335)
K2	PMXxx .6 .8 -EB25/EB30	0,10-0,20	0,10-0,25	0,80-1,80	1,00-2,40	1,20-3,00	-	25 (20-40)	40 (30-70)	45 (35-80)	-	80 (50-100)	90 (55-110)
K3	PMXxx .6 .8 -EB25/EB30	0,10-0,20	0,10-0,25	0,80-2,20	1,00-2,80	1,20-3,50	25 (15-30)	60 (40-100)	80 (30-150)	90 (35-170)	-	220 (120-300)	245 (135-335)
K4	PMXxx .6 .8 -EB25/EB30	0,10-0,20	0,10-0,25	0,80-2,20	1,00-2,80	1,20-3,50	25 (15-30)	45 (30-70)	70 (40-120)	80 (45-135)	100 (70-150)	150 (80-200)	170 (90-225)
K5	PMXxx .6 .8 -EB25/EB30	0,10-0,20	0,10-0,25	0,80-2,20	1,00-2,80	1,20-3,50	25 (15-30)	45 (30-70)	70 (40-120)	80 (45-135)	100 (70-150)	150 (80-200)	170 (90-225)
K6	PMXxx .6 .8 -EB25/EB30	0,10-0,20	0,10-0,25	0,80-1,80	1,00-2,40	1,20-3,00	-	60 (40-100)	80 (30-150)	90 (35-170)	-	220 (120-300)	245 (135-335)
K7	PMXxx .6 .8 -EB25/EB30	0,10-0,20	0,10-0,25	0,80-1,80	1,00-2,40	1,20-3,00	-	60 (40-100)	80 (30-150)	90 (35-170)	-	220 (120-300)	245 (135-335)
N1	PMXxx .6 .8 -EB25/EB30	0,10-0,20	0,10-0,30	0,80-2,20	1,00-2,80	1,20-3,50	50 (30-100)	-	-	-	-	-	-
N2	PMXxx .6 .8 -EB25/EB30	0,10-0,20	0,10-0,30	0,80-2,20	1,00-2,80	1,20-3,50	50 (30-100)	-	-	-	-	-	-
N3	PMXxx .6 .8 -EB25/EB30	0,10-0,20	0,10-0,30	0,80-2,20	1,00-2,80	1,20-3,50	50 (30-100)	-	-	-	-	-	-
N11	PMXxx .6 .8 -EB25/EB30	0,10-0,20	0,10-0,30	0,80-2,20	1,00-2,80	1,20-3,50	50 (30-100)	-	-	-	-	-	-
PM1	PMXxx .6 .8 -EB25/EB30	0,10-0,20	0,10-0,30	0,50-1,80	0,80-2,00	1,00-2,50	-	50 (30-80)	70 (40-100)	-	-	-	-
PM2	PMXxx .6 .8 -EB25/EB30	0,10-0,20	0,10-0,30	0,50-1,80	0,80-2,00	1,00-2,50	-	50 (30-80)	70 (40-100)	-	-	-	-
PM3	PMXxx .6 .8 -EB25/EB30	0,10-0,20	0,10-0,30	0,50-1,80	0,80-2,00	1,00-2,50	-	50 (30-80)	70 (40-100)	-	-	-	-

SMG = Grupy materiałowe Seco

a_p = mm

f = mm/obr

v_c = m/min

Wszystkie parametry są wartościami początkowymi

Wstęp

Wiercenie

Rozwiercanie

Wyłaczanie

Załącznik

Parametry skrawania – PM Plus... -EB25/EB30 cale

SMG		a _p (°)		f			v _c						
		z=6	z=8 z=10	z=6	z=8	z=10	H15	CP20	RX2000	RK2050	CF	RX1500	RK1550
P1	PMXxx..6..8-EB25/EB30	.004-.008	.004-.012	.031-.071	.039-.094	.047-.118	80 (50-100)	195 (100-330)	260 (100-490)	-	590 (295-655)	720 (395-985)	-
P2	PMXxx..6..8-EB25/EB30	.004-.008	.004-.012	.031-.071	.039-.094	.047-.118	80 (50-100)	195 (100-330)	260 (100-490)	-	590 (295-655)	720 (395-985)	-
P3	PMXxx..6..8-EB25/EB30	.004-.008	.004-.012	.031-.071	.039-.094	.047-.118	80 (50-100)	195 (100-330)	260 (100-490)	-	590 (295-655)	720 (395-985)	-
P4	PMXxx..6..8-EB25/EB30	.004-.008	.004-.012	.031-.071	.039-.094	.047-.118	65 (35-80)	165 (100-260)	195 (100-395)	-	395 (260-490)	590 (295-655)	-
P5	PMXxx..6..8-EB25/EB30	.004-.008	.004-.012	.031-.071	.039-.094	.047-.118	65 (35-80)	165 (100-260)	195 (100-395)	-	395 (260-490)	590 (295-655)	-
P6	PMXxx..6..8-EB25/EB30	.004-.008	.004-.012	.031-.071	.039-.094	.047-.118	65 (35-80)	165 (100-260)	195 (100-395)	-	395 (260-490)	590 (295-655)	-
P7	PMXxx..6..8-EB25/EB30	.004-.008	.004-.012	.031-.071	.039-.094	.047-.118	65 (35-80)	165 (100-260)	195 (100-395)	-	395 (260-490)	590 (295-655)	-
M1	PMXxx..6..8-EB25/EB30	.003-.006	.004-.008	.031-.047	.039-.079	.039-.098	-	80 (50-130)	115 (65-230)	-	-	-	-
K1	PMXxx..6..8-EB25/EB30	.004-.008	.004-.010	.031-.087	.039-.110	.047-.138	80 (50-100)	195 (130-330)	260 (100-490)	290 (110-550)	-	720 (395-985)	805 (440-1105)
K2	PMXxx..6..8-EB25/EB30	.004-.008	.004-.010	.031-.071	.039-.094	.047-.118	-	80 (65-130)	130 (100-230)	145 (110-260)	-	260 (165-330)	290 (185-370)
K3	PMXxx..6..8-EB25/EB30	.004-.008	.004-.010	.031-.087	.039-.110	.047-.138	80 (50-100)	195 (130-330)	260 (100-490)	290 (110-550)	-	720 (395-985)	805 (440-1105)
K4	PMXxx..6..8-EB25/EB30	.004-.008	.004-.010	.031-.087	.039-.110	.047-.138	80 (50-100)	150 (100-230)	230 (130-395)	260 (145-440)	330 (230-490)	490 (260-655)	550 (290-735)
K5	PMXxx..6..8-EB25/EB30	.004-.008	.004-.010	.031-.087	.039-.110	.047-.138	80 (50-100)	150 (100-230)	230 (130-395)	260 (145-440)	330 (230-490)	490 (260-655)	550 (290-735)
K6	PMXxx..6..8-EB25/EB30	.004-.008	.004-.010	.031-.071	.039-.094	.047-.118	-	195 (130-330)	260 (100-490)	290 (110-550)	-	720 (395-985)	805 (440-1105)
K7	PMXxx..6..8-EB25/EB30	.004-.008	.004-.010	.031-.071	.039-.094	.047-.118	-	195 (130-330)	260 (100-490)	290 (110-550)	-	720 (395-985)	805 (440-1105)
N1	PMXxx..6..8-EB25/EB30	.004-.008	.004-.012	.031-.087	.039-.110	.047-.138	165 (100-330)	-	-	-	-	-	-
N2	PMXxx..6..8-EB25/EB30	.004-.008	.004-.012	.031-.087	.039-.110	.047-.138	165 (100-330)	-	-	-	-	-	-
N3	PMXxx..6..8-EB25/EB30	.004-.008	.004-.012	.031-.087	.039-.110	.047-.138	165 (100-330)	-	-	-	-	-	-
N11	PMXxx..6..8-EB25/EB30	.004-.008	.004-.012	.031-.087	.039-.110	.047-.138	165 (100-330)	-	-	-	-	-	-
PM1	PMXxx..6..8-EB25/EB30	.004-.008	.004-.012	.020-.071	.031-.079	.039-.098	-	165 (100-260)	230 (130-330)	-	-	-	-
PM2	PMXxx..6..8-EB25/EB30	.004-.008	.004-.012	.020-.071	.031-.079	.039-.098	-	165 (100-260)	230 (130-330)	-	-	-	-
PM3	PMXxx..6..8-EB25/EB30	.004-.008	.004-.012	.020-.071	.031-.079	.039-.098	-	165 (100-260)	230 (130-330)	-	-	-	-

SMG = Grupy materiałowe Seco

a_p = calowe

f = cal/obr.

v_c = stp/min

Wszystkie parametry są wartościami początkowymi

Wstęp

Wiercenie

Rozwiercanie

Wytaczanie

Załącznik



NANOFIX™

Rozwiertaki Nanofix™ z węglików spiekanych są przeznaczone do małych średnic, od 2,97 do 12,05 mm (0.117 do 0.474”).

- Wewnętrzne chłodzenie z prostym
- systemem regulacji, do ustawiania wylotu dla otworu przelotowego lub nieprzelotowego, zależnie od zastosowania
- Pozwala uzyskać tolerancje pomiędzy 10 i 15 μm (0.0004–0.0006”)
- Osiem dostępnych geometrii: EB45, EBS45, EB845, EB25, EB30, EBS30, EB60 i EB75

Przegląd asortymentu

	Zakres \varnothing	Głębokość rozwiercania	Tolerancja \varnothing otworu	Średnice pośrednie	Wykończenie powierzchni
<p>Nanofix™</p> 	2,97-12,05 mm (0.1169-0.4744")	5-12 x D	IT 7	Tak, dostępne w ramach projektu niestandardowego	R_a 0,8-1,2 μ m (R_a 31-47 μ in)

Nanofix™ to program rozwiertaków węglkowych Seco przeznaczony do małych średnic od 2,97 do 12,05 mm (od 0.1169 do 0.4744").

W skład asortymentu wchodzi unikalny, szybki system mocowania, który pozwala na obsługę całego zakresu średnic tylko przy użyciu 2 wielkości oprawek.

Oprawki są wyposażone w wewnętrzny układ chłodzenia z prostym układem regulacji, dzięki czemu można ustawić sposób wypływu dla otworu przelotowego lub nieprzelotowego, w zależności od zastosowania.

System Quick-fit

System Quick-fit

Szybka i łatwa wymiana narzędzia
Dokładność i powtarzalność mocowania.

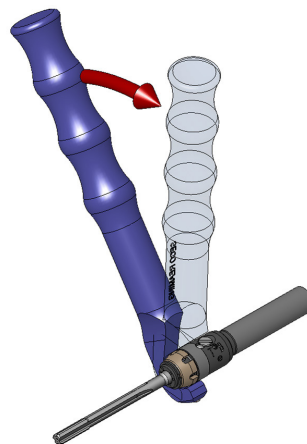

2 Wielkości Quick-fit obejmujące cały zakres



Szybkozłączka \varnothing 10 mm do
 \varnothing 6,051–12,050 mm
(\varnothing 0.2382–0.4744")

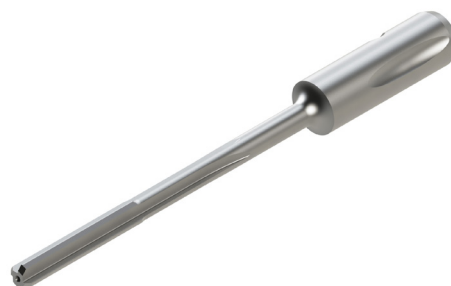

Szybkozłączka \varnothing 6 mm do
 \varnothing 2,97–6,050 mm
(\varnothing 0.1169–0.2382")

To samo narzędzie do otworów przelotowych i nieprzelotowych.

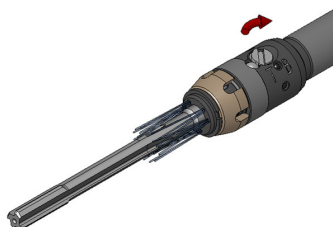

przelotowy

Zmiana systemu chłodzenia z otw. przelotowego
na nieprzelotowy i odwrotnie, polega na przekr.
o 1/4 obrotu śruby.

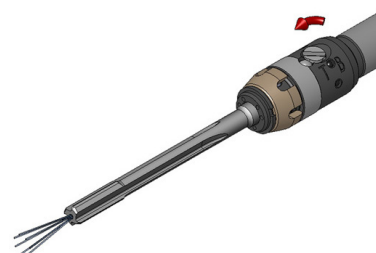

nieprzelotowy

Oznaczenia

Chwyty

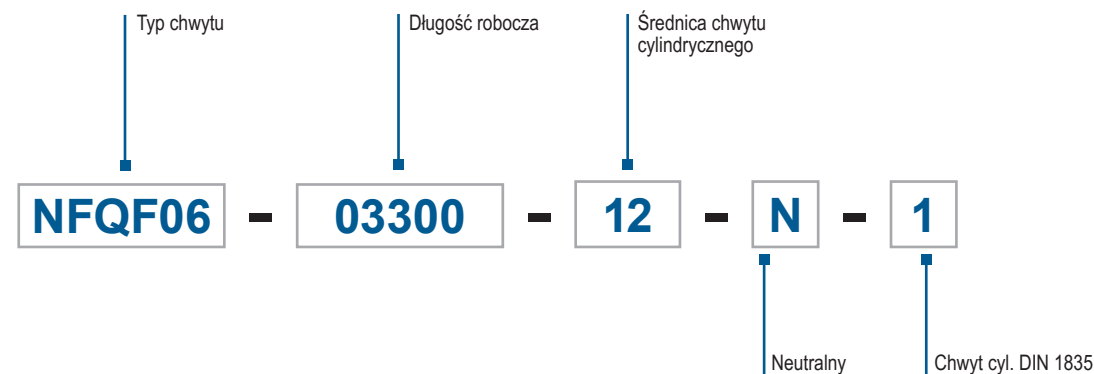

Rozwiertaki

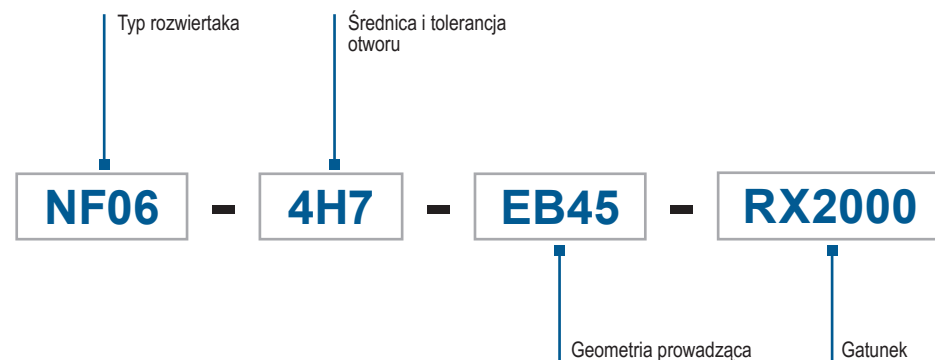

Rozwiertaki o średnicy pośredniej

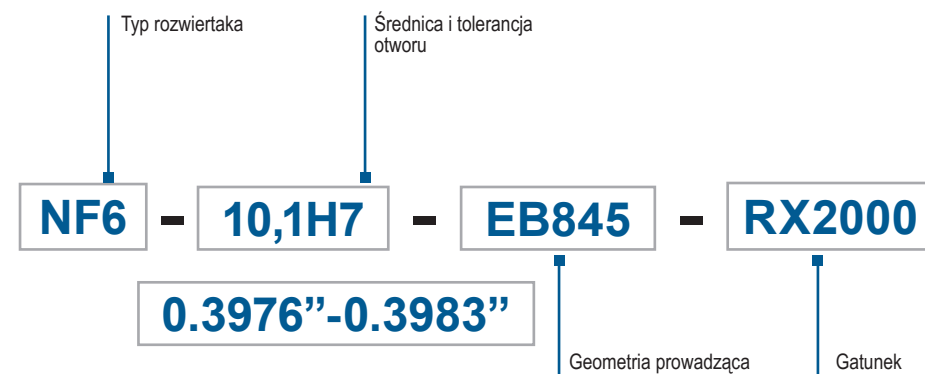

NF06/NF10/NS06/NS10: Proste ostrza, odpowiednie do otworów przelotowych i nieprzelotowych.
 NF4/NS4: Prawa linia śrubowa, odpowiednie do otworów nieprzelotowych tylko.
 NF6/NS6: Lewa linia śrubowa, odpowiednie do otworów przelotowych tylko.
 Lewa linia śrubowa poprawia odprowadzanie wiórów do przodu.
 Prawa linia śrubowa poprawia odprowadzanie wiórów z otworu.
 Patrz wybór geometrii Nanofix na stronach 369.

Bicie

Narzędzie obrotowe

Maks. zalecane bicie: 5 μm (197 μcala).
Zalecana jest oprawka precyzyjna: Oprawka hydrauliczna, oprawka na tulejki typu D lub tulejki 5672.

Uwaga: z powodu uszczelki w układzie doprowadzenia chłodzenia nie zaleca się mocowania w oprawce Shrinkfit.

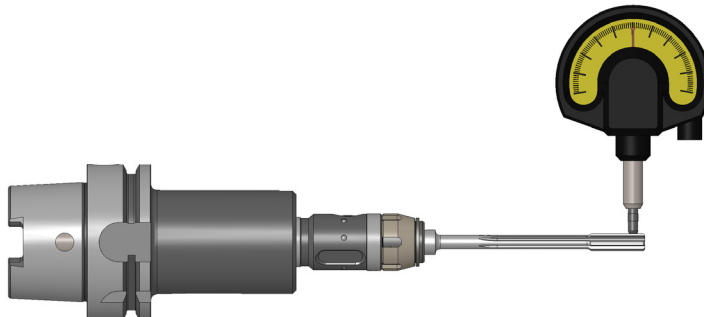

Narzędzie nieobrotowe

Użyć uchwytu wahlowego Seco, patrz str. 481-485.

Uchwyt wahlowy umożliwia samocentrowanie rozwiertaka w otworze wstępnym.

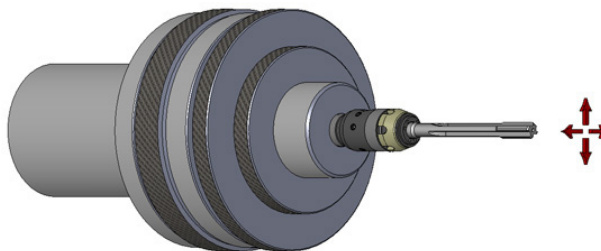

Wymagania odnośnie chłodzenia

Celem uzyskania maksymalnej trwałości ostrza oraz jakości otworu należy spełnić poniższe wymagania.

Zalecane jest chłodzenie przez narzędzie.
Zewnętrzne chłodzenie można stosować po zmniejszeniu parametrów skrawania o 75%.

Dobrej jakości olej rozpuszczalny z dodatkiem min. 40% oleju mineralnego.
Do stali nierdzewnej zaleca się olej bez domieszek.

Koncentracja min 6-8%
Filtracja 30–50 μm (1181–1969 μcala).
Wydatek min. 0,5 l/min/mm (0.13 gal/min/cal) średnicy rozwiertaka (np. Rozwiertak $\varnothing 10$, min. wydatek wynosi 5 l/min (1.3 gal/min)).

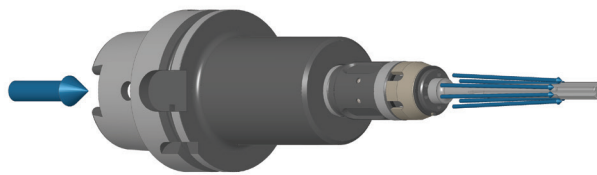

Pomiar średnicy







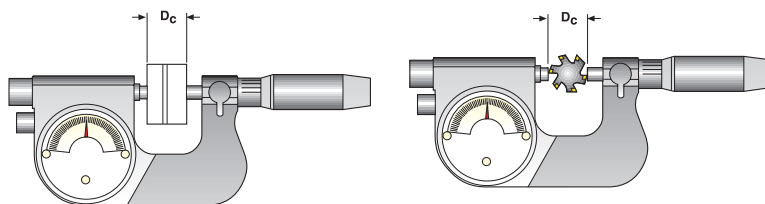

Mikrometryczny czujnik zegarowy przed pomiarem średnicy.

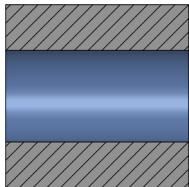
Uwaga!
Rozwiertak Nanofix posiada zmienną podziałkę zębów.
Podczas pomiaru upewnij się, że mierzysz 2 ostrza zorientowane względem siebie o 180°

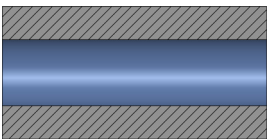
Do pomiaru należy użyć czujnika mikrometrycznego oraz podstawki.

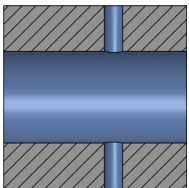
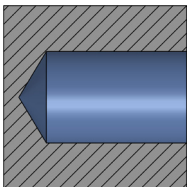

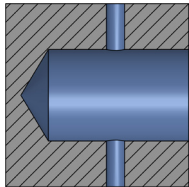
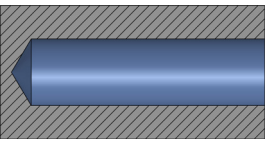
Wybór geometrii

Obrabiany detal	Zakres średnic \varnothing 2,97–12,50 mm (0.1169–0.4744")
<p>Krótki otwór przelotowy < 3 x D</p> 	<p>Proste ostrza</p> <p>NF06 NS06 NF10 NS10</p> 
<p>Długi otwór przelotowy > 3 x D</p> 	<p>Lewoskrętna linia śrubowa</p> <p>NF6 NS6</p> 
<p>Otwór przecinający inny</p> 	
<p>Otwór nieprzelotowy</p> 	<p>Proste ostrza</p> <p>NF06 NS06 NF10 NS10</p> 
<p>Otwór nieprzelotowy przecinający inny</p> 	
<p>Otwór nieprzelotowy > 3x D.</p> 	<p>Prawoskrętna linia śrubowa</p> <p>NF4 NS4</p> 

Wstęp

Wiercenie

Rozwiercanie

Wytaczanie

Zalącznik

Wybór geometrii - Zastosowania

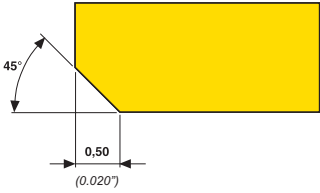
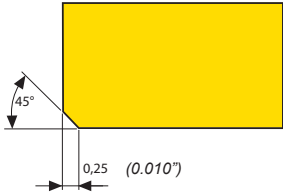
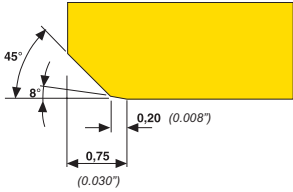
Geometria wejścia - EB45	
<p>Kontrola wióra ++ Gładkość powierzchni +++ R_a 0,8–1,2 μm (Gładkość powierzchni +++ R_a 31 – 47 μcal) Uniwersalność</p>	
Geometria wejścia - EBS45	
<p>Kontrola wióra +++ Gładkość powierzchni + R_a 0,8–1,2 (Gładkość powierzchni + R_a 31 – 47 μcal) Krótki EB45</p>	
Geometria wejścia - EB845	
<p>Kontrola wióra ++ Gładkość powierzchni +++ R_a 0,2–0,8 μm (Gładkość powierzchni +++ R_a 8–31 μcal)</p>	

Wstęp

Wiercenie

Rozwiercanie

Wytłaczanie

Załącznik

Wybór geometrii - Zastosowania

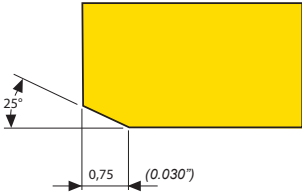
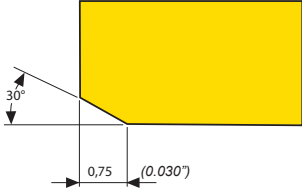
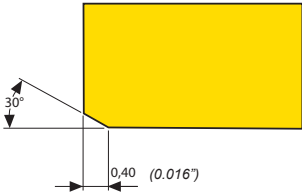
Geometria wejścia - EB25	
<p>Wydajność posuwu +++ Gładkość powierzchni ++ R_a 0,4–0,8 μm (Gładkość powierzchni ++ R_a 16–31 μcala) Kontrola wióra +</p>	
Geometria wejścia - EB30	
<p>Wydajność posuwu +++ Gładkość powierzchni ++ R_a 0,4–0,8 μm (Gładkość powierzchni ++ R_a 16–31 μcala) Kontrola wióra +</p>	
Geometria wejścia - EBS30	
<p>Wydajność posuwu +++ Gładkość powierzchni ++ R_a 0,4–0,8 μm (Gładkość powierzchni ++ R_a 16–31 μcala) Kontrola wióra + Krótki EB30</p>	

Wstęp

Wiercenie

Rozwiercanie

Wytaczanie

Załącznik

Wybór geometrii - Zastosowania

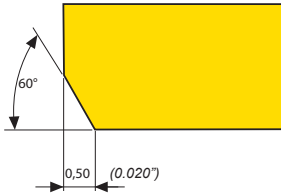
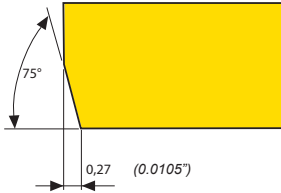
Geometria wejścia - EB60	
<p>Wydajność posuwu + Gładkość powierzchni ++ R_a 0,8–1,2 μm (gładkość powierzchni ++ R_a 31–47 μcala) Kontrola wióra ++</p>	
Geometria wejścia - EB75	
<p>Wydajność posuwu + Gładkość powierzchni ++ R_a 0,8–1,2 μm (Gładkość powierzchni ++ R_a 31–47 μcala) Kontrola wióra ++</p>	

Wstęp

Wiercenie

Rozwiercanie

Wytaczanie

Załącznik

Gatunki		
	RX2000	Pokrywany Węglik o wysokiej wydajności odpowiedni do wszystkich materiałów..
	CP20	Pokrywany Uniwersalny gatunek odpowiedni dla większości materiałów, z wyjątkiem aluminium. TiN
	H15	Pokrywany Ciągły węglik mikro-ziarnisty do wszystkich materiałów. Odpowiedni do operacji dokładnego rozwiercania dzięki bardzo dużej ostrości krawędzi.
	RN2010	Niepokrywany Gatunek mikroziarnisty o zoptymalizowanej geometrii dla materiałów N (nieżelaznych).
	RM2020	Pokrywany Gatunek ciągły, odpowiedni do obróbki precyzyjnej z zoptymalizowaną geometrią dla materiałów M.
	RM2090	Pokrywany Gatunek odpornym na ścieranie, o określonych geometriach dla materiałów typu M. Optymalizacja dla materiałów typu M.
	RK2050	Pokrywany Gatunek ciągły, odpowiedni do rozwiercania z zoptymalizowaną geometrią dla materiałów K.
	RS2090	Pokrywany Gatunek odpornym na ścieranie, o określonych geometriach dla materiałów typu S. Optymalizacja dla materiałów typu S.

Wstęp

Wiercenie

Rozwiercanie

Wyłaczanie

Załącznik

Rozwiertak do otworów nieprzelotowych i przelotowych

Ø 2,97-12,05 mm / 0.116-0.474"

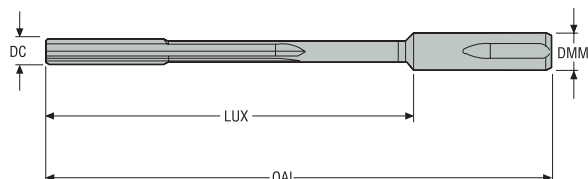

Oznaczenie	Numer produktu	DC	Hole dia min-max			LUX	DMM	OAL		Geometrie			Gatunki		
			mm Cal.	mm Cal.	mm Cal.					mm Cal.	mm Cal.	mm Cal.	EB45	EB845	EB30
NF06-2.98H7-EB45	02728853	2,98 0.1173	2,98 0.1173	2,99 0.1177	40,0 1.5750	6,0 0.2360	60,0 2.3620	4	■	□	□	■	□	□	
NF06-2.99H7-EB45	02728854	2,99 0.1177	2,99 0.1177	3,0 0.1181	40,0 1.5750	6,0 0.2360	60,0 2.3620	4	■	□	□	■	□	□	
NF06-3H7-EB45	02728858	3,0 0.1181	3,0 0.1181	3,01 0.1185	40,0 1.5750	6,0 0.2360	60,0 2.3620	4	■	□	□	■	□	□	
NF06-3.01H7-EB45	02728860	3,01 0.1185	3,01 0.1185	3,022 0.1190	40,0 1.5750	6,0 0.2360	60,0 2.3620	4	■	□	□	■	□	□	
NF06-3.02H7-EB45	02728862	3,02 0.1189	3,02 0.1189	3,032 0.1194	40,0 1.5750	6,0 0.2360	60,0 2.3620	4	■	□	□	■	□	□	
NF06-3.03H7-EB45	02728864	3,03 0.1193	3,03 0.1193	3,042 0.1198	40,0 1.5750	6,0 0.2360	60,0 2.3620	4	■	□	□	■	□	□	
NF06-3.04H7-EB45	02728865	3,04 0.1197	3,04 0.1197	3,052 0.1202	40,0 1.5750	6,0 0.2360	60,0 2.3620	4	■	□	□	■	□	□	
NF06-3.05H7-EB45	02728866	3,05 0.1201	3,05 0.1201	3,062 0.1206	40,0 1.5750	6,0 0.2360	60,0 2.3620	4	■	□	□	■	□	□	
NF06-3.167H7-EB45	02761485	3,167 0.1247	3,167 0.1247	3,179 0.1252	60,0 2.3620	6,0 0.2360	80,0 3.1500	4	■	□	□	■	□	□	
NF06-3.175H7-EB45	02761489	3,175 0.1250	3,175 0.1250	3,187 0.1255	60,0 2.3620	6,0 0.2360	80,0 3.1500	4	■	□	□	■	□	□	
NF06-3.5H7-EB45	02728868	3,5 0.1378	3,5 0.1378	3,512 0.1383	60,0 2.3620	6,0 0.2360	80,0 3.1500	4	■	□	□	■	□	□	
NF06-3.51H7-EB45	02728869	3,51 0.1382	3,51 0.1382	3,522 0.1387	60,0 2.3620	6,0 0.2360	80,0 3.1500	4	■	□	□	■	□	□	
NF06-3.97H7-EB45	02728871	3,97 0.1563	3,97 0.1563	3,982 0.1568	60,0 2.3620	6,0 0.2360	80,0 3.1500	4	■	□	□	■	□	□	
NF06-3.98H7-EB45	02728872	3,98 0.1567	3,98 0.1567	3,992 0.1572	60,0 2.3620	6,0 0.2360	80,0 3.1500	4	■	□	□	■	□	□	
NF06-3.99H7-EB45	02728873	3,99 0.1571	3,99 0.1571	4,002 0.1576	60,0 2.3620	6,0 0.2360	80,0 3.1500	4	■	□	□	■	□	□	
NF06-4H7-EB45	02728874	4,0 0.1575	4,0 0.1575	4,012 0.1580	60,0 2.3620	6,0 0.2360	80,0 3.1500	4	■	□	□	■	□	□	
NF06-4.01H7-EB45	02728875	4,01 0.1579	4,01 0.1579	4,022 0.1583	60,0 2.3620	6,0 0.2360	80,0 3.1500	4	■	□	□	■	□	□	
NF06-4.02H7-EB45	02728876	4,02 0.1583	4,02 0.1583	4,032 0.1587	60,0 2.3620	6,0 0.2360	80,0 3.1500	4	■	□	□	■	□	□	
NF06-4.04H7-EB45	02728879	4,04 0.1591	4,04 0.1591	4,052 0.1595	60,0 2.3620	6,0 0.2360	80,0 3.1500	4	■	□	□	■	□	□	
NF06-4.05H7-EB45	02728880	4,05 0.1594	4,05 0.1594	4,062 0.1599	60,0 2.3620	6,0 0.2360	80,0 3.1500	4	■	□	□	■	□	□	
NF06-4.5H7-EB45	02728881	4,5 0.1772	4,5 0.1772	4,512 0.1776	60,0 2.3620	6,0 0.2360	80,0 3.1500	4	■	□	□	■	□	□	
NF06-4.750H7-EB45	02761490	4,75 0.1870	4,75 0.1870	4,762 0.1875	60,0 2.3620	6,0 0.2360	80,0 3.1500	4	■	□	□	■	□	□	
NF06-4.762H7-EB45	02761494	4,762 0.1875	4,762 0.1875	4,774 0.1880	60,0 2.3620	6,0 0.2360	80,0 3.1500	4	■	□	□	■	□	□	

Oznaczenie	Numer produktu	DC			Hole dia min-max			LUX	DMM	OAL		Geometrie			Gatunki		
		mm Cal.	mm Cal.	mm Cal.	mm Cal.	mm Cal.	mm Cal.					mm Cal.	EB45	EB45	EB30	RX2000	H15
NF06-4.97H7-EB45	02728882	4,97 0.1957	4,97 0.1957	4,982 0.1961	60,0 2.3620	6,0 0.2360	80,0 3.1500	4		<input checked="" type="checkbox"/>	<input type="checkbox"/>	<input type="checkbox"/>	<input checked="" type="checkbox"/>	<input type="checkbox"/>	<input type="checkbox"/>		
NF06-4.98H7-EB45	02728883	4,98 0.1961	4,98 0.1961	4,992 0.1965	60,0 2.3620	6,0 0.2360	80,0 3.1500	4		<input checked="" type="checkbox"/>	<input type="checkbox"/>	<input type="checkbox"/>	<input checked="" type="checkbox"/>	<input type="checkbox"/>	<input type="checkbox"/>		
NF06-4.99H7-EB45	02728884	4,99 0.1965	4,99 0.1965	5,002 0.1969	60,0 2.3620	6,0 0.2360	80,0 3.1500	4		<input checked="" type="checkbox"/>	<input type="checkbox"/>	<input type="checkbox"/>	<input checked="" type="checkbox"/>	<input type="checkbox"/>	<input type="checkbox"/>		
NF06-5H7-EB45	02728927	5,0 0.1969	5,0 0.1969	5,012 0.1973	60,0 2.3620	6,0 0.2360	80,0 3.1500	4		<input checked="" type="checkbox"/>	<input type="checkbox"/>	<input type="checkbox"/>	<input checked="" type="checkbox"/>	<input type="checkbox"/>	<input type="checkbox"/>		
NF06-5.01H7-EB45	02728928	5,01 0.1972	5,01 0.1972	5,022 0.1977	60,0 2.3620	6,0 0.2360	80,0 3.1500	4		<input checked="" type="checkbox"/>	<input type="checkbox"/>	<input type="checkbox"/>	<input checked="" type="checkbox"/>	<input type="checkbox"/>	<input type="checkbox"/>		
NF06-5.02H7-EB45	02728929	5,02 0.1976	5,02 0.1976	5,032 0.1981	60,0 2.3620	6,0 0.2360	80,0 3.1500	4		<input checked="" type="checkbox"/>	<input type="checkbox"/>	<input type="checkbox"/>	<input checked="" type="checkbox"/>	<input type="checkbox"/>	<input type="checkbox"/>		
NF06-5.03H7-EB45	02728930	5,03 0.1980	5,03 0.1980	5,042 0.1985	60,0 2.3620	6,0 0.2360	80,0 3.1500	4		<input checked="" type="checkbox"/>	<input type="checkbox"/>	<input type="checkbox"/>	<input checked="" type="checkbox"/>	<input type="checkbox"/>	<input type="checkbox"/>		
NF06-5.05H7-EB45	02728932	5,05 0.1988	5,05 0.1988	5,062 0.1993	60,0 2.3620	6,0 0.2360	80,0 3.1500	4		<input checked="" type="checkbox"/>	<input type="checkbox"/>	<input type="checkbox"/>	<input checked="" type="checkbox"/>	<input type="checkbox"/>	<input type="checkbox"/>		
NF06-5.5H7-EB45	02728933	5,5 0.2165	5,5 0.2165	5,512 0.2170	60,0 2.3620	6,0 0.2360	80,0 3.1500	4		<input checked="" type="checkbox"/>	<input type="checkbox"/>	<input type="checkbox"/>	<input checked="" type="checkbox"/>	<input type="checkbox"/>	<input type="checkbox"/>		
NF06-5.97H7-EB45	02728934	5,97 0.2350	5,97 0.2350	5,982 0.2355	60,0 2.3620	6,0 0.2360	80,0 3.1500	4		<input checked="" type="checkbox"/>	<input type="checkbox"/>	<input type="checkbox"/>	<input checked="" type="checkbox"/>	<input type="checkbox"/>	<input type="checkbox"/>		
NF06-5.98H7-EB45	02728935	5,98 0.2354	5,98 0.2354	5,992 0.2359	60,0 2.3620	6,0 0.2360	80,0 3.1500	4		<input checked="" type="checkbox"/>	<input type="checkbox"/>	<input type="checkbox"/>	<input checked="" type="checkbox"/>	<input type="checkbox"/>	<input type="checkbox"/>		
NF06-5.99H7-EB45	02728936	5,99 0.2358	5,99 0.2358	6,002 0.2363	60,0 2.3620	6,0 0.2360	80,0 3.1500	4		<input checked="" type="checkbox"/>	<input type="checkbox"/>	<input type="checkbox"/>	<input checked="" type="checkbox"/>	<input type="checkbox"/>	<input type="checkbox"/>		
NF06-6H7-EB45	02728937	6,0 0.2362	6,0 0.2362	6,015 0.2368	60,0 2.3620	6,0 0.2360	80,0 3.1500	4		<input checked="" type="checkbox"/>	<input type="checkbox"/>	<input type="checkbox"/>	<input checked="" type="checkbox"/>	<input type="checkbox"/>	<input type="checkbox"/>		
NF06-6.01H7-EB45	02728938	6,01 0.2366	6,01 0.2366	6,025 0.2372	60,0 2.3620	6,0 0.2360	80,0 3.1500	4		<input checked="" type="checkbox"/>	<input type="checkbox"/>	<input type="checkbox"/>	<input checked="" type="checkbox"/>	<input type="checkbox"/>	<input type="checkbox"/>		
NF06-6.02H7-EB45	02728939	6,02 0.2370	6,02 0.2370	6,035 0.2376	60,0 2.3620	6,0 0.2360	80,0 3.1500	4		<input checked="" type="checkbox"/>	<input type="checkbox"/>	<input type="checkbox"/>	<input checked="" type="checkbox"/>	<input type="checkbox"/>	<input type="checkbox"/>		
NF06-6.03H7-EB45	02728940	6,03 0.2374	6,03 0.2374	6,045 0.2380	60,0 2.3620	6,0 0.2360	80,0 3.1500	4		<input checked="" type="checkbox"/>	<input type="checkbox"/>	<input type="checkbox"/>	<input checked="" type="checkbox"/>	<input type="checkbox"/>	<input type="checkbox"/>		
NF06-6.04H7-EB45	02728941	6,04 0.2378	6,04 0.2378	6,055 0.2384	60,0 2.3620	6,0 0.2360	80,0 3.1500	4		<input checked="" type="checkbox"/>	<input type="checkbox"/>	<input type="checkbox"/>	<input checked="" type="checkbox"/>	<input type="checkbox"/>	<input type="checkbox"/>		
NF06-6.05H7-EB45	02728942	6,05 0.2382	6,05 0.2382	6,065 0.2388	60,0 2.3620	6,0 0.2360	80,0 3.1500	4		<input checked="" type="checkbox"/>	<input type="checkbox"/>	<input type="checkbox"/>	<input checked="" type="checkbox"/>	<input type="checkbox"/>	<input type="checkbox"/>		
NF10-6.334H7-EB45	02761987	6,334 0.2494	6,33 0.2492	6,345 0.2498	83,0 3.2680	10,0 0.3940	115,0 4.5280	6		<input checked="" type="checkbox"/>	<input type="checkbox"/>	<input type="checkbox"/>	<input checked="" type="checkbox"/>	<input type="checkbox"/>	<input type="checkbox"/>		
NF10-6.350H7-EB45	02762016	6,35 0.2500	6,35 0.2500	6,365 0.2506	83,0 3.2680	10,0 0.3940	115,0 4.5280	6		<input checked="" type="checkbox"/>	<input type="checkbox"/>	<input type="checkbox"/>	<input checked="" type="checkbox"/>	<input type="checkbox"/>	<input type="checkbox"/>		
NF10-6.3754H7-EB45	02762017	6,375 0.2510	6,375 0.2510	6,39 0.2516	83,0 3.2680	10,0 0.3940	115,0 4.5280	6		<input checked="" type="checkbox"/>	<input type="checkbox"/>	<input type="checkbox"/>	<input checked="" type="checkbox"/>	<input type="checkbox"/>	<input type="checkbox"/>		
NF10-6.5H7-EB45	02728943	6,5 0.2559	6,5 0.2559	6,515 0.2565	83,0 3.2680	10,0 0.3940	115,0 4.5280	6		<input checked="" type="checkbox"/>	<input type="checkbox"/>	<input type="checkbox"/>	<input checked="" type="checkbox"/>	<input type="checkbox"/>	<input type="checkbox"/>		
NF10-6.98H7-EB45	02728947	6,98 0.2748	6,98 0.2748	6,995 0.2754	83,0 3.2680	10,0 0.3940	115,0 4.5280	6		<input checked="" type="checkbox"/>	<input type="checkbox"/>	<input type="checkbox"/>	<input checked="" type="checkbox"/>	<input type="checkbox"/>	<input type="checkbox"/>		
NF10-7H7-EB45	02728949	7,0 0.2756	7,0 0.2756	7,015 0.2762	83,0 3.2680	10,0 0.3940	115,0 4.5280	6		<input checked="" type="checkbox"/>	<input type="checkbox"/>	<input type="checkbox"/>	<input checked="" type="checkbox"/>	<input type="checkbox"/>	<input type="checkbox"/>		
NF10-7.01H7-EB45	02728950	7,01 0.2760	7,01 0.2760	7,025 0.2766	83,0 3.2680	10,0 0.3940	115,0 4.5280	6		<input checked="" type="checkbox"/>	<input type="checkbox"/>	<input type="checkbox"/>	<input checked="" type="checkbox"/>	<input type="checkbox"/>	<input type="checkbox"/>		
NF10-7.02H7-EB45	02728951	7,02 0.2764	7,02 0.2764	7,035 0.2770	83,0 3.2680	10,0 0.3940	115,0 4.5280	6		<input checked="" type="checkbox"/>	<input type="checkbox"/>	<input type="checkbox"/>	<input checked="" type="checkbox"/>	<input type="checkbox"/>	<input type="checkbox"/>		
NF10-7.05H7-EB45	02728954	7,05 0.2776	7,05 0.2776	7,065 0.2781	83,0 3.2680	10,0 0.3940	115,0 4.5280	6		<input checked="" type="checkbox"/>	<input type="checkbox"/>	<input type="checkbox"/>	<input checked="" type="checkbox"/>	<input type="checkbox"/>	<input type="checkbox"/>		
NF10-7.5H7-EB45	02728955	7,5 0.2953	7,5 0.2953	7,515 0.2959	83,0 3.2680	10,0 0.3940	115,0 4.5280	6		<input checked="" type="checkbox"/>	<input type="checkbox"/>	<input type="checkbox"/>	<input checked="" type="checkbox"/>	<input type="checkbox"/>	<input type="checkbox"/>		
NF10-7.9375H7-EB45	02762018	7,9375 0.3125	7,937 0.3125	7,952 0.3131	83,0 3.2680	10,0 0.3940	115,0 4.5280	6		<input checked="" type="checkbox"/>	<input type="checkbox"/>	<input type="checkbox"/>	<input checked="" type="checkbox"/>	<input type="checkbox"/>	<input type="checkbox"/>		
NF10-7.97H7-EB45	02728956	7,97 0.3138	7,97 0.3138	7,985 0.3144	83,0 3.2680	10,0 0.3940	115,0 4.5280	6		<input checked="" type="checkbox"/>	<input type="checkbox"/>	<input type="checkbox"/>	<input checked="" type="checkbox"/>	<input type="checkbox"/>	<input type="checkbox"/>		

Wstęp

Wiercenie

Rozwiercanie

Wytaczanie

Załącznik

Oznaczenie	Numer produktu	DC			Hole dia min-max			LUX	DMM	OAL		Geometrie			Gatunki		
		mm Cal.	mm Cal.	mm Cal.	mm Cal.	mm Cal.	mm Cal.					mm Cal.	mm Cal.	mm Cal.	mm Cal.	mm Cal.	EB45
NF10-7.98H7-EB45	02728957	7,98 0.3142	7,98 0.3142	7,995 0.3148	83,0 3.2680	10,0 0.3940	115,0 4.5280	6				■	□	□	■	□	□
NF10-7.99H7-EB45	02728958	7,99 0.3146	7,99 0.3146	8,005 0.3152	83,0 3.2680	10,0 0.3940	115,0 4.5280	6				■	□	□	■	□	□
NF10-8H7-EB45	02728959	8,0 0.3150	8,0 0.3150	8,015 0.3156	83,0 3.2680	10,0 0.3940	115,0 4.5280	6				■	□	□	■	□	□
NF10-8.01H7-EB45	02728960	8,01 0.3154	8,01 0.3154	8,025 0.3159	83,0 3.2680	10,0 0.3940	115,0 4.5280	6				■	□	□	■	□	□
NF10-8.02H7-EB45	02728961	8,02 0.3157	8,02 0.3157	8,035 0.3163	83,0 3.2680	10,0 0.3940	115,0 4.5280	6				■	□	□	■	□	□
NF10-8.03H7-EB45	02728962	8,03 0.3161	8,03 0.3161	8,045 0.3167	83,0 3.2680	10,0 0.3940	115,0 4.5280	6				■	□	□	■	□	□
NF10-8.04H7-EB45	02728963	8,04 0.3165	8,04 0.3165	8,055 0.3171	83,0 3.2680	10,0 0.3940	115,0 4.5280	6				■	□	□	■	□	□
NF10-8.05H7-EB45	02728964	8,05 0.3169	8,05 0.3169	8,065 0.3175	83,0 3.2680	10,0 0.3940	115,0 4.5280	6				■	□	□	■	□	□
NF10-8.5H7-EB45	02728965	8,5 0.3346	8,5 0.3346	8,515 0.3352	93,0 3.6610	10,0 0.3940	125,0 4.9210	6				■	□	□	■	□	□
NF10-9H7-EB45	02728974	9,0 0.3543	9,0 0.3543	9,015 0.3549	93,0 3.6610	10,0 0.3940	125,0 4.9210	6				■	□	□	■	□	□
NF10-9.01H7-EB45	02728975	9,01 0.3547	9,01 0.3547	9,025 0.3553	93,0 3.6610	10,0 0.3940	125,0 4.9210	6				■	□	□	■	□	□
NF10-9.05H7-EB45	02728979	9,05 0.3563	9,05 0.3563	9,065 0.3569	93,0 3.6610	10,0 0.3940	125,0 4.9210	6				■	□	□	■	□	□
NF10-9.5H7-EB45	02728980	9,5 0.3740	9,5 0.3740	9,515 0.3746	93,0 3.6610	10,0 0.3940	125,0 4.9210	6				■	□	□	■	□	□
NF10-9.5250H7-EB45	02762020	9,525 0.3750	9,525 0.3750	9,54 0.3756	93,0 3.6610	10,0 0.3940	125,0 4.9210	6				■	□	□	■	□	□
NF10-9.97H7-EB45	02728981	9,97 0.3925	9,97 0.3925	9,985 0.3931	93,0 3.6610	10,0 0.3940	125,0 4.9210	6				■	□	□	■	□	□
NF10-9.98H7-EB45	02728982	9,98 0.3929	9,98 0.3929	9,995 0.3935	93,0 3.6610	10,0 0.3940	125,0 4.9210	6				■	□	□	■	□	□
NF10-9.99H7-EB45	02728983	9,99 0.3933	9,99 0.3933	10,005 0.3939	93,0 3.6610	10,0 0.3940	125,0 4.9210	6				■	□	□	■	□	□
NF10-10H7-EB45	02728986	10,0 0.3937	10,0 0.3937	10,015 0.3943	93,0 3.6610	10,0 0.3940	125,0 4.9210	6				■	□	□	■	□	□
NF10-10.01H7-EB45	02728987	10,01 0.3941	10,01 0.3941	10,028 0.3948	93,0 3.6610	10,0 0.3940	125,0 4.9210	6				■	□	□	■	□	□
NF10-10.02H7-EB45	02728988	10,02 0.3945	10,02 0.3945	10,038 0.3952	93,0 3.6610	10,0 0.3940	125,0 4.9210	6				■	□	□	■	□	□
NF10-10.04H7-EB45	02728990	10,04 0.3953	10,04 0.3953	10,058 0.3960	93,0 3.6610	10,0 0.3940	125,0 4.9210	6				■	□	□	■	□	□
NF10-10.05H7-EB45	02728991	10,05 0.3957	10,05 0.3957	10,068 0.3964	93,0 3.6610	10,0 0.3940	125,0 4.9210	6				■	□	□	■	□	□
NF10-11H7-EB45	02728997	11,0 0.4331	11,0 0.4331	11,018 0.4338	114,0 4.4880	10,0 0.3940	145,0 5.7090	6				■	□	□	■	□	□
NF10-11.04H7-EB45	02729004	11,04 0.4346	11,04 0.4346	11,058 0.4354	114,0 4.4880	10,0 0.3940	145,0 5.7090	6				■	□	□	■	□	□
NF10-11.05H7-EB45	02729005	11,05 0.4350	11,05 0.4350	11,068 0.4357	114,0 4.4880	10,0 0.3940	145,0 5.7090	6				■	□	□	■	□	□
NF10-11.112H7-EB45	02762021	11,112 0.4375	11,112 0.4375	11,13 0.4382	114,0 4.4880	10,0 0.3940	145,0 5.7090	6				■	□	□	■	□	□
NF10-11.97H7-EB45	02729008	11,97 0.4713	11,97 0.4713	11,988 0.4720	114,0 4.4880	10,0 0.3940	145,0 5.7090	6				■	□	□	■	□	□
NF10-11.98H7-EB45	02729009	11,98 0.4717	11,98 0.4717	11,998 0.4724	114,0 4.4880	10,0 0.3940	145,0 5.7090	6				■	□	□	■	□	□
NF10-11.99H7-EB45	02729010	11,99 0.4720	11,99 0.4720	12,008 0.4728	114,0 4.4880	10,0 0.3940	145,0 5.7090	6				■	□	□	■	□	□
NF10-12H7-EB45	02729011	12,0 0.4724	12,0 0.4724	12,018 0.4731	114,0 4.4880	10,0 0.3940	145,0 5.7090	6				■	□	□	■	□	□

Wstęp

Wiercenie

Rozwiercanie

Wyłaczanie

Załącznik

Oznaczenie	Numer produktu	DC	Hole dia min-max			LUX	DMM	OAL		Geometrie			Gatunki		
		mm Cal.	mm Cal.	mm Cal.	mm Cal.	mm Cal.	mm Cal.	mm Cal.		EB45	EB845	EB30	RX2000	H15	H15
NF10-12.01H7-EB45	02729012	12,01 0.4728	12,01 0.4728	12,028 0.4735	114,0 4.4880	10,0 0.3940	145,0 5.7090	6	<input checked="" type="checkbox"/>	<input type="checkbox"/>	<input type="checkbox"/>	<input checked="" type="checkbox"/>	<input type="checkbox"/>	<input type="checkbox"/>	
NF10-12.02H7-EB45	02729013	12,02 0.4732	12,02 0.4732	12,038 0.4739	114,0 4.4880	10,0 0.3940	145,0 5.7090	6	<input checked="" type="checkbox"/>	<input type="checkbox"/>	<input type="checkbox"/>	<input checked="" type="checkbox"/>	<input type="checkbox"/>	<input type="checkbox"/>	
NF10-12.03H7-EB45	02729014	12,03 0.4736	12,03 0.4736	12,048 0.4743	114,0 4.4880	10,0 0.3940	145,0 5.7090	6	<input checked="" type="checkbox"/>	<input type="checkbox"/>	<input type="checkbox"/>	<input checked="" type="checkbox"/>	<input type="checkbox"/>	<input type="checkbox"/>	
NF10-12.04H7-EB45	02729015	12,04 0.4740	12,04 0.4740	12,058 0.4747	114,0 4.4880	10,0 0.3940	145,0 5.7090	6	<input checked="" type="checkbox"/>	<input type="checkbox"/>	<input type="checkbox"/>	<input checked="" type="checkbox"/>	<input type="checkbox"/>	<input type="checkbox"/>	
NF10-12.05H7-EB45	02729016	12,05 0.4744	12,05 0.4744	12,068 0.4751	114,0 4.4880	10,0 0.3940	145,0 5.7090	6	<input checked="" type="checkbox"/>	<input type="checkbox"/>	<input type="checkbox"/>	<input checked="" type="checkbox"/>	<input type="checkbox"/>	<input type="checkbox"/>	

Wyrób standardowy. Standard niemagazynowany.

Uwaga: Przy zamawianiu rozwiertaka Nanofix dla średnic pośrednich należy podać średnicę i tolerancję rozwiercanego otworu.

Przykładowe zamówienie: NF10-10.187/10.213-EB845, RX2000.

Wstęp

Wiercenie

Rozwiercanie

Wytaczanie

Załącznik

Średnice pośrednie

Ostrza proste, wersja długa, do otworów przelotowych i nieprzelotowych

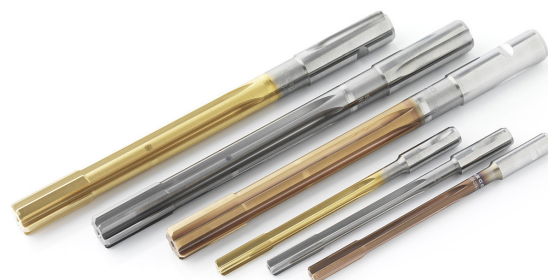
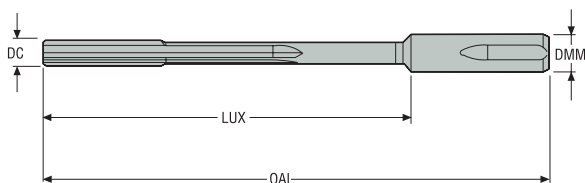

- Wybór geometrii, patrz str. 369-371
- Parametry skrawania, patrz strona (strony) 389-396

Oznaczenie	DCN	DCX	LUX	DMM	OAL	Wielkość korpusu	Geometrie	Gatunki							
	mm Cal.	mm Cal.	mm Cal.	mm Cal.	mm Cal.				H15	RK2050	RX2000	RN2010	RM2020	RM2090	RS2090
NF06-2.970-XX-XXXX	2,97 0.117	3,05 0.120	40,0 0.120	6,0 0.236	60,0 2.362	4	NFQF06-xx	EB45 EB845 EB30	<input type="checkbox"/>	<input type="checkbox"/>	<input type="checkbox"/>	<input type="checkbox"/>	<input type="checkbox"/>	<input type="checkbox"/>	<input type="checkbox"/>
NF06-3.051-XX-XXXX	3,051 0.120	6,05 0.238	60,0 0.238	6,0 0.236	80,0 3.150	4	NFQF06-xx	EB45 EB845 EB30	<input type="checkbox"/>	<input type="checkbox"/>	<input type="checkbox"/>	<input type="checkbox"/>	<input type="checkbox"/>	<input type="checkbox"/>	<input type="checkbox"/>
NF10-6.051-XX-XXXX	6,051 0.238	8,05 0.317	83,0 0.317	10,0 0.394	115,0 4.528	6	NFQF10-xx	EB45 EB845 EB30	<input type="checkbox"/>	<input type="checkbox"/>	<input type="checkbox"/>	<input type="checkbox"/>	<input type="checkbox"/>	<input type="checkbox"/>	<input type="checkbox"/>
NF10-8.051-XX-XXXX	8,051 0.317	10,05 0.396	93,0 0.396	10,0 0.394	125,0 4.921	6	NFQF10-xx	EB45 EB845 EB30	<input type="checkbox"/>	<input type="checkbox"/>	<input type="checkbox"/>	<input type="checkbox"/>	<input type="checkbox"/>	<input type="checkbox"/>	<input type="checkbox"/>
NF10-10.051-XX-XXXX	10,051 0.396	12,05 0.474	114,0 0.474	10,0 0.394	145,0 5.709	6	NFQF10-xx	EB45 EB845 EB30	<input type="checkbox"/>	<input type="checkbox"/>	<input type="checkbox"/>	<input type="checkbox"/>	<input type="checkbox"/>	<input type="checkbox"/>	<input type="checkbox"/>

= Pozycja niestandardowa.

Uwaga: Przy zamawianiu rozwiertaka Nanofix dla średnic pośrednich należy podać średnicę i tolerancję rozwiercanego otworu.

Przykładowe zamówienie: NF06-5.187/5.213-EB845, RX2000.

Średnice pośrednie

Lewa linia śrubowa, wersja długa, do otworów przelotowych

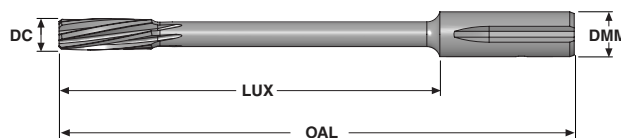

- Wybór geometrii, patrz str. 369-371
- Parametry skrawania, patrz strona (strony) 389-396

Oznaczenie	DCN	DCX	LUX	DMM	OAL		Wielkość korpusu	Geometrie	Gatunki						
	mm Cal.	mm Cal.							H15	RK2050	RX2000	RN2010	RM2020	RM2090	RS2090
NF6-2.970-XX-XXXX	2,97 0.117	3,05 0.120	40,0 1.575	6,0 0.236	60,0 2.362	4	NFQF06-xx	EB45 EB845 EB30	<input type="checkbox"/>	<input type="checkbox"/>	<input type="checkbox"/>	<input type="checkbox"/>	<input type="checkbox"/>	<input type="checkbox"/>	<input type="checkbox"/>
NF6-3.051-XX-XXXX	3,051 0.120	6,05 0.238	60,0 2.362	6,0 0.236	80,0 3.150	4	NFQF06-xx	EB45 EB845 EB30	<input type="checkbox"/>	<input type="checkbox"/>	<input type="checkbox"/>	<input type="checkbox"/>	<input type="checkbox"/>	<input type="checkbox"/>	<input type="checkbox"/>
NF6-6.051-XX-XXXX	6,051 0.238	8,05 0.317	83,0 3.268	10,0 0.394	115,0 4.528	6	NFQF10-xx	EB45 EB845 EB30	<input type="checkbox"/>	<input type="checkbox"/>	<input type="checkbox"/>	<input type="checkbox"/>	<input type="checkbox"/>	<input type="checkbox"/>	<input type="checkbox"/>
NF6-8.051-XX-XXXX	8,051 0.317	10,05 0.396	93,0 3.661	10,0 0.394	125,0 4.921	6	NFQF10-xx	EB45 EB845 EB30	<input type="checkbox"/>	<input type="checkbox"/>	<input type="checkbox"/>	<input type="checkbox"/>	<input type="checkbox"/>	<input type="checkbox"/>	<input type="checkbox"/>
NF6-10.051-XX-XXXX	10,051 0.396	12,05 0.474	114,0 4.488	10,0 0.394	145,0 5.709	6	NFQF10-xx	EB45 EB845 EB30	<input type="checkbox"/>	<input type="checkbox"/>	<input type="checkbox"/>	<input type="checkbox"/>	<input type="checkbox"/>	<input type="checkbox"/>	<input type="checkbox"/>

= Pozycja niestandardowa.

Uwaga: Przy zamawianiu rozwiertaka Nanofix dla średnic pośrednich należy podać średnicę i tolerancję rozwiercanego otworu.

Przykładowe zamówienie: NF6-5.187/5.213-EB845, RX2000.

Średnice pośrednie

Prawa linia śrubowa, wersja długa, do otworów nieprzewodzących

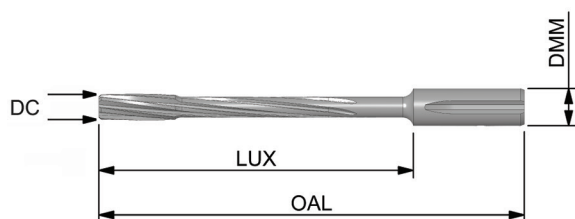

- Wybór geometrii, patrz str. 369-371
- Parametry skrawania, patrz strona (strony) 389-396

Oznaczenie	DCN	DCX	LUX	DMM	OAL	Wielkość korpusu	Geometrie	Gatunki							
	mm Cal.	mm Cal.	mm Cal.	mm Cal.	mm Cal.			H15	RK2050	RX2000	RN2010	RM2020	RM2090	RS2090	
NF4-2.970-XX-XXXX	2,97 0.117	3,05 0.120	40,0 1.575	6,0 0.236	60,0 2.362	4	NFQF06-xx	EB45 EB845	<input type="checkbox"/>	<input type="checkbox"/>	<input type="checkbox"/>	<input type="checkbox"/>	<input type="checkbox"/>	<input type="checkbox"/>	<input type="checkbox"/>
NF4-3.051-XX-XXXX	3,051 0.120	6,05 0.238	60,0 2.362	6,0 0.236	80,0 3.150	4	NFQF06-xx	EB45 EB845	<input type="checkbox"/>	<input type="checkbox"/>	<input type="checkbox"/>	<input type="checkbox"/>	<input type="checkbox"/>	<input type="checkbox"/>	<input type="checkbox"/>
NF4-4.051-XX-XXXX	6,051 0.238	8,05 0.317	83,0 3.268	10,0 0.394	115,0 4.528	6	NFQF10-xx	EB45 EB845	<input type="checkbox"/>	<input type="checkbox"/>	<input type="checkbox"/>	<input type="checkbox"/>	<input type="checkbox"/>	<input type="checkbox"/>	<input type="checkbox"/>
NF4-8.051-XX-XXXX	8,051 0.317	10,05 0.396	93,0 3.661	10,0 0.394	125,0 4.921	6	NFQF10-xx	EB45 EB845	<input type="checkbox"/>	<input type="checkbox"/>	<input type="checkbox"/>	<input type="checkbox"/>	<input type="checkbox"/>	<input type="checkbox"/>	<input type="checkbox"/>
NF4-10.051-XX-XXXX	10,051 0.396	12,05 0.474	114,0 4.488	10,0 0.394	145,0 5.709	6	NFQF10-xx	EB45 EB845	<input type="checkbox"/>	<input type="checkbox"/>	<input type="checkbox"/>	<input type="checkbox"/>	<input type="checkbox"/>	<input type="checkbox"/>	<input type="checkbox"/>

= Pozycja niestandardowa.

Uwaga: Przy zamawianiu rozwiertaka Nanofix dla średnic pośrednich należy podać średnicę i tolerancję rozwiercanego otworu.

Przykładowe zamówienie: NF4-10.187/10.213-EB845, RX2000.

Rozwiertak do otworów nieprzelotowych i przelotowych – wersja krótka

∅ 2,97-12,05 mm / 0.116-0.474"

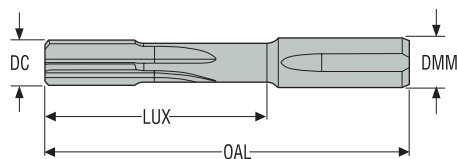

Oznaczenie	Numer produktu	Hole dia min-max			LUX	DMM	OAL		Geometrie			Gatunki		
		mm Cal.	mm Cal.	mm Cal.					EB45	EB845	EB30	RX2000	H15	H15
NS06-2.97H7-EB...	-	2,97 0.1169	2,97 0.1169	2,98 0.1173	25,0 0.9840	6,0 0.2360	45,0 1.7720	4	<input type="checkbox"/>	<input type="checkbox"/>	<input type="checkbox"/>	<input type="checkbox"/>	<input type="checkbox"/>	<input type="checkbox"/>
NS06-2.98H7-EB...	-	2,98 0.1173	2,98 0.1173	2,99 0.1177	25,0 0.9840	6,0 0.2360	45,0 1.7720	4	<input type="checkbox"/>	<input type="checkbox"/>	<input type="checkbox"/>	<input type="checkbox"/>	<input type="checkbox"/>	<input type="checkbox"/>
NS06-2.99H7-EB...	-	2,99 0.1177	2,99 0.1177	3,00 0.1181	25,0 0.9840	6,0 0.2360	45,0 1.7720	4	<input type="checkbox"/>	<input type="checkbox"/>	<input type="checkbox"/>	<input type="checkbox"/>	<input type="checkbox"/>	<input type="checkbox"/>
NS06-3.00H7-EB...	-	3,0 0.1181	3,00 0.1181	3,01 0.1185	25,0 0.9840	6,0 0.2360	45,0 1.7720	4	<input type="checkbox"/>	<input type="checkbox"/>	<input type="checkbox"/>	<input type="checkbox"/>	<input type="checkbox"/>	<input type="checkbox"/>
NS06-3H7-EB30	10019456	3,0 0.1181	3,01 0.1185	3,00 0.1181	25,0 0.9840	6,0 0.2360	45,0 1.7720	4	<input type="checkbox"/>	<input type="checkbox"/>	<input checked="" type="checkbox"/>	<input checked="" type="checkbox"/>	<input type="checkbox"/>	<input type="checkbox"/>
NS06-3.01H7-EB...	-	3,01 0.1185	3,01 0.1185	3,02 0.1190	25,0 0.9840	6,0 0.2360	45,0 1.7720	4	<input type="checkbox"/>	<input type="checkbox"/>	<input type="checkbox"/>	<input type="checkbox"/>	<input type="checkbox"/>	<input type="checkbox"/>
NS06-3.02H7-EB...	-	3,02 0.1189	3,02 0.1189	3,03 0.1194	25,0 0.9840	6,0 0.2360	45,0 1.7720	4	<input type="checkbox"/>	<input type="checkbox"/>	<input type="checkbox"/>	<input type="checkbox"/>	<input type="checkbox"/>	<input type="checkbox"/>
NS06-3.03H7-EB...	-	3,03 0.1193	3,03 0.1193	3,04 0.1198	25,0 0.9840	6,0 0.2360	45,0 1.7720	4	<input type="checkbox"/>	<input type="checkbox"/>	<input type="checkbox"/>	<input type="checkbox"/>	<input type="checkbox"/>	<input type="checkbox"/>
NS06-3.04H7-EB...	-	3,04 0.1197	3,04 0.1197	3,05 0.1202	25,0 0.9840	6,0 0.2360	45,0 1.7720	4	<input type="checkbox"/>	<input type="checkbox"/>	<input type="checkbox"/>	<input type="checkbox"/>	<input type="checkbox"/>	<input type="checkbox"/>
NS06-3.05H7-EB...	-	3,05 0.1201	3,05 0.1201	3,06 0.1206	25,0 0.9840	6,0 0.2360	45,0 1.7720	4	<input type="checkbox"/>	<input type="checkbox"/>	<input type="checkbox"/>	<input type="checkbox"/>	<input type="checkbox"/>	<input type="checkbox"/>
NS06-3.167H7-EB...	-	3,167 0.1247	3,18 0.1252	3,17 0.1247	30,0 1.1810	6,0 0.2360	50,0 1.9690	4	<input type="checkbox"/>	<input type="checkbox"/>	<input type="checkbox"/>	<input type="checkbox"/>	<input type="checkbox"/>	<input type="checkbox"/>
NS06-3.175H7-EB...	-	3,175 0.1250	3,18 0.1250	3,19 0.1255	30,0 1.1810	6,0 0.2360	50,0 1.9690	4	<input type="checkbox"/>	<input type="checkbox"/>	<input type="checkbox"/>	<input type="checkbox"/>	<input type="checkbox"/>	<input type="checkbox"/>
NS06-3.49H7-EB...	-	3,49 0.1374	3,49 0.1374	3,50 0.1379	30,0 1.1810	6,0 0.2360	50,0 1.9690	4	<input type="checkbox"/>	<input type="checkbox"/>	<input type="checkbox"/>	<input type="checkbox"/>	<input type="checkbox"/>	<input type="checkbox"/>
NS06-3.50H7-EB...	-	3,5 0.1378	3,50 0.1378	3,51 0.1383	30,0 1.1810	6,0 0.2360	50,0 1.9690	4	<input type="checkbox"/>	<input type="checkbox"/>	<input type="checkbox"/>	<input type="checkbox"/>	<input type="checkbox"/>	<input type="checkbox"/>
NS06-3.51H7-EB...	-	3,51 0.1382	3,51 0.1382	3,52 0.1387	30,0 1.1810	6,0 0.2360	50,0 1.9690	4	<input type="checkbox"/>	<input type="checkbox"/>	<input type="checkbox"/>	<input type="checkbox"/>	<input type="checkbox"/>	<input type="checkbox"/>
NS06-3.52H7-EB...	-	3,52 0.1386	3,52 0.1386	3,53 0.1391	30,0 1.1810	6,0 0.2360	50,0 1.9690	4	<input type="checkbox"/>	<input type="checkbox"/>	<input type="checkbox"/>	<input type="checkbox"/>	<input type="checkbox"/>	<input type="checkbox"/>
NS06-3.97H7-EB...	-	3,97 0.1563	3,97 0.1563	3,98 0.1568	30,0 1.1810	6,0 0.2360	50,0 1.9690	4	<input type="checkbox"/>	<input type="checkbox"/>	<input type="checkbox"/>	<input type="checkbox"/>	<input type="checkbox"/>	<input type="checkbox"/>
NS06-3.98H7-EB...	-	3,98 0.1567	3,98 0.1567	3,99 0.1572	30,0 1.1810	6,0 0.2360	50,0 1.9690	4	<input type="checkbox"/>	<input type="checkbox"/>	<input type="checkbox"/>	<input type="checkbox"/>	<input type="checkbox"/>	<input type="checkbox"/>
NS06-3.99H7-EB...	-	3,99 0.1571	3,99 0.1571	4,00 0.1576	30,0 1.1810	6,0 0.2360	50,0 1.9690	4	<input type="checkbox"/>	<input type="checkbox"/>	<input type="checkbox"/>	<input type="checkbox"/>	<input type="checkbox"/>	<input type="checkbox"/>
NS06-4.00H7-EB...	-	4,0 0.1575	4,00 0.1575	4,01 0.1580	30,0 1.1810	6,0 0.2360	50,0 1.9690	4	<input type="checkbox"/>	<input type="checkbox"/>	<input type="checkbox"/>	<input type="checkbox"/>	<input type="checkbox"/>	<input type="checkbox"/>
NS06-4H7-EB30	10019457	4,0 0.1575	4,01 0.1580	4,00 0.1575	30,0 1.1810	6,0 0.2360	50,0 1.9690	4	<input type="checkbox"/>	<input type="checkbox"/>	<input checked="" type="checkbox"/>	<input checked="" type="checkbox"/>	<input type="checkbox"/>	<input type="checkbox"/>
NS06-4.01H7-EB...	-	4,01 0.1579	4,01 0.1579	4,02 0.1583	30,0 1.1810	6,0 0.2360	50,0 1.9690	4	<input type="checkbox"/>	<input type="checkbox"/>	<input type="checkbox"/>	<input type="checkbox"/>	<input type="checkbox"/>	<input type="checkbox"/>
NS06-4.02H7-EB...	-	4,02 0.1583	4,02 0.1583	4,03 0.1587	30,0 1.1810	6,0 0.2360	50,0 1.9690	4	<input type="checkbox"/>	<input type="checkbox"/>	<input type="checkbox"/>	<input type="checkbox"/>	<input type="checkbox"/>	<input type="checkbox"/>

Wstęp

Wiercenie

Rozwiercanie

Wytaczanie

Załącznik

Oznaczenie	Numer produktu	DC			Hole dia min-max			LUX	DMM	OAL		Geometrie			Gatunki		
		mm Cal.	mm Cal.	mm Cal.	mm Cal.	mm Cal.	mm Cal.					mm Cal.	mm Cal.	mm Cal.	EB45	EB45	EB30
NS06-4.03H7-EB...	-	4,03 0.1587	4,03 0.1587	4,04 0.1591	30,0 1.1810	6,0 0.2360	50,0 1.9690	4									
NS06-4.04H7-EB...	-	4,04 0.1591	4,04 0.1591	4,05 0.1595	30,0 1.1810	6,0 0.2360	50,0 1.9690	4									
NS06-4.05H7-EB...	-	4,05 0.1594	4,05 0.1594	4,06 0.1599	30,0 1.1810	6,0 0.2360	50,0 1.9690	4									
NS06-4.50H7-EB...	-	4,5 0.1772	4,50 0.1772	4,51 0.1776	30,0 1.1810	6,0 0.2360	50,0 1.9690	4									
NS06-4.750H7-EB...	-	4,75 0.1870	4,75 0.1870	4,76 0.1875	30,0 1.1810	6,0 0.2360	50,0 1.9690	4									
NS06-4.750H7-EB30	10019458	4,75 0.1870	4,76 0.1875	4,75 0.1870	30,0 1.1810	6,0 0.2360	50,0 1.9690	4									
NS06-4.762H7-EB...	-	4,762 0.1875	4,76 0.1875	4,77 0.1880	30,0 1.1810	6,0 0.2360	50,0 1.9690	4									
NS06-4.97H7-EB...	-	4,97 0.1957	4,97 0.1957	4,98 0.1961	30,0 1.1810	6,0 0.2360	50,0 1.9690	4									
NS06-4.98H7-EB...	-	4,98 0.1961	4,98 0.1961	4,99 0.1965	30,0 1.1810	6,0 0.2360	50,0 1.9690	4									
NS06-4.99H7-EB...	-	4,99 0.1965	4,99 0.1965	5,00 0.1969	30,0 1.1810	6,0 0.2360	50,0 1.9690	4									
NS06-5.00H7-EB...	-	5,0 0.1969	5,00 0.1969	5,01 0.1973	30,0 1.1810	6,0 0.2360	50,0 1.9690	4									
NS06-5H7-EB30	10019459	5,0 0.1969	5,01 0.1973	5,00 0.1969	30,0 1.1810	6,0 0.2360	50,0 1.9690	4									
NS06-5.01H7-EB...	-	5,01 0.1972	5,01 0.1972	5,02 0.1977	30,0 1.1810	6,0 0.2360	50,0 1.9690	4									
NS06-5.02H7-EB...	-	5,02 0.1976	5,02 0.1976	5,03 0.1981	30,0 1.1810	6,0 0.2360	50,0 1.9690	4									
NS06-5.03H7-EB...	-	5,03 0.1980	5,03 0.1980	5,04 0.1985	30,0 1.1810	6,0 0.2360	50,0 1.9690	4									
NS06-5.04H7-EB...	-	5,04 0.1984	5,04 0.1984	5,05 0.1989	30,0 1.1810	6,0 0.2360	50,0 1.9690	4									
NS06-5.05H7-EB...	-	5,05 0.1988	5,05 0.1988	5,06 0.1993	30,0 1.1810	6,0 0.2360	50,0 1.9690	4									
NS06-5.50H7-EB...	-	5,5 0.2165	5,50 0.2165	5,51 0.2170	30,0 1.1810	6,0 0.2360	50,0 1.9690	4									
NS06-5.97H7-EB...	-	5,97 0.2350	5,97 0.2350	5,98 0.2355	31,0 1.2200	6,0 0.2360	50,0 1.9690	4									
NS06-5.98H7-EB...	-	5,98 0.2354	5,98 0.2354	5,99 0.2359	31,0 1.2200	6,0 0.2360	50,0 1.9690	4									
NS06-5.99H7-EB...	-	5,99 0.2358	5,99 0.2358	6,00 0.2363	31,0 1.2200	6,0 0.2360	50,0 1.9690	4									
NS06-6.00H7-EB...	-	6,0 0.2362	6,00 0.2362	6,01 0.2367	31,0 1.2200	6,0 0.2360	50,0 1.9690	4									
NS06-6H7-EB30	10019460	6,0 0.2362	6,01 0.2367	6,00 0.2362	31,0 1.2200	6,0 0.2360	50,0 1.9690	4									
NS06-6.01H7-EB...	-	6,01 0.2366	6,01 0.2366	6,03 0.2372	31,0 1.2200	6,0 0.2360	50,0 1.9690	4									
NS06-6.02H7-EB...	-	6,02 0.2370	6,02 0.2370	6,04 0.2376	31,0 1.2200	6,0 0.2360	50,0 1.9690	4									
NS06-6.03H7-EB...	-	6,03 0.2374	6,03 0.2374	6,05 0.2380	31,0 1.2200	6,0 0.2360	50,0 1.9690	4									
NS06-6.04H7-EB...	-	6,04 0.2378	6,04 0.2378	6,06 0.2384	31,0 1.2200	6,0 0.2360	50,0 1.9690	4									
NS06-6.05H7-EB...	-	6,05 0.2382	6,05 0.2382	6,07 0.2388	31,0 1.2200	6,0 0.2360	50,0 1.9690	4									
NS10-6.334H7-EB...	-	6,334 0.2494	6,33 0.2494	6,35 0.2500	46,0 1.8110	10,0 0.3940	78,0 3.0710	6									
NS10-6.334H7-EB30	10019461	6,334 0.2494	6,35 0.2500	6,33 0.2494	46,0 1.8110	10,0 0.3940	78,0 3.0710	4									

Wstęp

Wiercenie

Rozwiercanie

Wytaczanie

Załącznik

Oznaczenie	Numer produktu	DC			Hole dia min-max			LUX	DMM	OAL	Geometrie			Gatunki		
		mm Cal.	mm Cal.	mm Cal.	mm Cal.	mm Cal.	mm Cal.				mm Cal.	mm Cal.	mm Cal.	mm Cal.	mm Cal.	mm Cal.
NS10-6.350H7-EB...	-	6,35 0.2500	6,35 0.2500	6,37 0.2506	46,0 1.8110	10,0 0.3940	78,0 3.0710	6		<input type="checkbox"/>	<input type="checkbox"/>	<input type="checkbox"/>	<input type="checkbox"/>	<input type="checkbox"/>	<input type="checkbox"/>	
NS10-6.375H7-EB...	-	6,375 0.2510	6,38 0.2510	6,39 0.2516	46,0 1.8110	10,0 0.3940	78,0 3.0710	6		<input type="checkbox"/>	<input type="checkbox"/>	<input type="checkbox"/>	<input type="checkbox"/>	<input type="checkbox"/>	<input type="checkbox"/>	
NS10-6.3754H7-EB30	10019462	6,375 0.2510	6,39 0.2516	6,38 0.2510	46,0 1.8110	10,0 0.3940	78,0 3.0710	4		<input type="checkbox"/>	<input type="checkbox"/>	<input checked="" type="checkbox"/>	<input checked="" type="checkbox"/>	<input type="checkbox"/>	<input type="checkbox"/>	
NS10-6.5H7-EB...	-	6,5 0.2559	6,50 0.2559	6,52 0.2565	46,0 1.8110	10,0 0.3940	78,0 3.0710	6		<input type="checkbox"/>	<input type="checkbox"/>	<input type="checkbox"/>	<input type="checkbox"/>	<input type="checkbox"/>	<input type="checkbox"/>	
NS10-6.97H7-EB...	-	6,97 0.2744	6,97 0.2744	6,99 0.2750	46,0 1.8110	10,0 0.3940	78,0 3.0710	6		<input type="checkbox"/>	<input type="checkbox"/>	<input type="checkbox"/>	<input type="checkbox"/>	<input type="checkbox"/>	<input type="checkbox"/>	
NS10-6.98H7-EB...	-	6,98 0.2748	6,98 0.2748	7,00 0.2754	46,0 1.8110	10,0 0.3940	78,0 3.0710	6		<input type="checkbox"/>	<input type="checkbox"/>	<input type="checkbox"/>	<input type="checkbox"/>	<input type="checkbox"/>	<input type="checkbox"/>	
NS10-6.99H7-EB...	-	6,99 0.2752	6,99 0.2752	7,01 0.2758	46,0 1.8110	10,0 0.3940	78,0 3.0710	6		<input type="checkbox"/>	<input type="checkbox"/>	<input type="checkbox"/>	<input type="checkbox"/>	<input type="checkbox"/>	<input type="checkbox"/>	
NS10-7.00H7-EB...	-	7,0 0.2756	7,00 0.2756	7,02 0.2762	46,0 1.8110	10,0 0.3940	78,0 3.0710	6		<input type="checkbox"/>	<input type="checkbox"/>	<input type="checkbox"/>	<input type="checkbox"/>	<input type="checkbox"/>	<input type="checkbox"/>	
NS10-7.02H7-EB30	10019463	7,0 0.2756	7,02 0.2762	7,00 0.2756	46,0 1.8110	10,0 0.3940	78,0 3.0710	4		<input type="checkbox"/>	<input type="checkbox"/>	<input checked="" type="checkbox"/>	<input checked="" type="checkbox"/>	<input type="checkbox"/>	<input type="checkbox"/>	
NS10-7.01H7-EB...	-	7,01 0.2760	7,01 0.2760	7,03 0.2766	46,0 1.8110	10,0 0.3940	78,0 3.0710	6		<input type="checkbox"/>	<input type="checkbox"/>	<input type="checkbox"/>	<input type="checkbox"/>	<input type="checkbox"/>	<input type="checkbox"/>	
NS10-7.02H7-EB...	-	7,02 0.2764	7,02 0.2764	7,04 0.2770	46,0 1.8110	10,0 0.3940	78,0 3.0710	6		<input type="checkbox"/>	<input type="checkbox"/>	<input type="checkbox"/>	<input type="checkbox"/>	<input type="checkbox"/>	<input type="checkbox"/>	
NS10-7.03H7-EB...	-	7,03 0.2768	7,03 0.2768	7,05 0.2774	46,0 1.8110	10,0 0.3940	78,0 3.0710	6		<input type="checkbox"/>	<input type="checkbox"/>	<input type="checkbox"/>	<input type="checkbox"/>	<input type="checkbox"/>	<input type="checkbox"/>	
NS10-7.04H7-EB...	-	7,04 0.2772	7,04 0.2772	7,06 0.2778	46,0 1.8110	10,0 0.3940	78,0 3.0710	6		<input type="checkbox"/>	<input type="checkbox"/>	<input type="checkbox"/>	<input type="checkbox"/>	<input type="checkbox"/>	<input type="checkbox"/>	
NS10-7.05H7-EB...	-	7,05 0.2776	7,05 0.2776	7,07 0.2781	46,0 1.8110	10,0 0.3940	78,0 3.0710	6		<input type="checkbox"/>	<input type="checkbox"/>	<input type="checkbox"/>	<input type="checkbox"/>	<input type="checkbox"/>	<input type="checkbox"/>	
NS10-7.50H7-EB...	-	7,5 0.2953	7,50 0.2953	7,52 0.2959	46,0 1.8110	10,0 0.3940	78,0 3.0710	6		<input type="checkbox"/>	<input type="checkbox"/>	<input type="checkbox"/>	<input type="checkbox"/>	<input type="checkbox"/>	<input type="checkbox"/>	
NS10-7.9375H7-EB...	-	7,9375 0.3125	7,94 0.3125	7,95 0.3131	46,0 1.8110	10,0 0.3940	78,0 3.0710	6		<input type="checkbox"/>	<input type="checkbox"/>	<input type="checkbox"/>	<input type="checkbox"/>	<input type="checkbox"/>	<input type="checkbox"/>	
NS10-7.97H7-EB...	-	7,97 0.3138	7,97 0.3138	7,99 0.3144	46,0 1.8110	10,0 0.3940	78,0 3.0710	6		<input type="checkbox"/>	<input type="checkbox"/>	<input type="checkbox"/>	<input type="checkbox"/>	<input type="checkbox"/>	<input type="checkbox"/>	
NS10-7.98H7-EB...	-	7,98 0.3142	7,98 0.3142	8,00 0.3148	46,0 1.8110	10,0 0.3940	78,0 3.0710	6		<input type="checkbox"/>	<input type="checkbox"/>	<input type="checkbox"/>	<input type="checkbox"/>	<input type="checkbox"/>	<input type="checkbox"/>	
NS10-7.99H7-EB...	-	7,99 0.3146	7,99 0.3146	8,01 0.3152	46,0 1.8110	10,0 0.3940	78,0 3.0710	6		<input type="checkbox"/>	<input type="checkbox"/>	<input type="checkbox"/>	<input type="checkbox"/>	<input type="checkbox"/>	<input type="checkbox"/>	
NS10-8.00H7-EB...	-	8,0 0.3150	8,00 0.3150	8,02 0.3156	46,0 1.8110	10,0 0.3940	78,0 3.0710	6		<input type="checkbox"/>	<input type="checkbox"/>	<input type="checkbox"/>	<input type="checkbox"/>	<input type="checkbox"/>	<input type="checkbox"/>	
NS10-8.02H7-EB30	10019464	8,0 0.3150	8,02 0.3156	8,00 0.3150	46,0 1.8110	10,0 0.3940	78,0 3.0710	4		<input type="checkbox"/>	<input type="checkbox"/>	<input checked="" type="checkbox"/>	<input checked="" type="checkbox"/>	<input type="checkbox"/>	<input type="checkbox"/>	
NS10-8.01H7-EB...	-	8,01 0.3154	8,01 0.3154	8,03 0.3159	46,0 1.8110	10,0 0.3940	78,0 3.0710	6		<input type="checkbox"/>	<input type="checkbox"/>	<input type="checkbox"/>	<input type="checkbox"/>	<input type="checkbox"/>	<input type="checkbox"/>	
NS10-8.02H7-EB...	-	8,02 0.3157	8,02 0.3157	8,04 0.3163	46,0 1.8110	10,0 0.3940	78,0 3.0710	6		<input type="checkbox"/>	<input type="checkbox"/>	<input type="checkbox"/>	<input type="checkbox"/>	<input type="checkbox"/>	<input type="checkbox"/>	
NS10-8.03H7-EB...	-	8,03 0.3161	8,03 0.3161	8,05 0.3167	46,0 1.8110	10,0 0.3940	78,0 3.0710	6		<input type="checkbox"/>	<input type="checkbox"/>	<input type="checkbox"/>	<input type="checkbox"/>	<input type="checkbox"/>	<input type="checkbox"/>	
NS10-8.04H7-EB...	-	8,04 0.3165	8,04 0.3165	8,06 0.3171	46,0 1.8110	10,0 0.3940	78,0 3.0710	6		<input type="checkbox"/>	<input type="checkbox"/>	<input type="checkbox"/>	<input type="checkbox"/>	<input type="checkbox"/>	<input type="checkbox"/>	
NS10-8.05H7-EB...	-	8,05 0.3169	8,05 0.3169	8,07 0.3175	46,0 1.8110	10,0 0.3940	78,0 3.0710	6		<input type="checkbox"/>	<input type="checkbox"/>	<input type="checkbox"/>	<input type="checkbox"/>	<input type="checkbox"/>	<input type="checkbox"/>	
NS10-8.50H7-EB...	-	8,5 0.3346	8,50 0.3346	8,52 0.3352	46,0 1.8110	10,0 0.3940	78,0 3.0710	6		<input type="checkbox"/>	<input type="checkbox"/>	<input type="checkbox"/>	<input type="checkbox"/>	<input type="checkbox"/>	<input type="checkbox"/>	
NS10-8.97H7-EB...	-	8,97 0.3531	8,97 0.3531	8,99 0.3537	46,0 1.8110	10,0 0.3940	78,0 3.0710	6		<input type="checkbox"/>	<input type="checkbox"/>	<input type="checkbox"/>	<input type="checkbox"/>	<input type="checkbox"/>	<input type="checkbox"/>	
NS10-8.98H7-EB...	-	8,98 0.3535	8,98 0.3535	9,00 0.3541	46,0 1.8110	10,0 0.3940	78,0 3.0710	6		<input type="checkbox"/>	<input type="checkbox"/>	<input type="checkbox"/>	<input type="checkbox"/>	<input type="checkbox"/>	<input type="checkbox"/>	
NS10-8.99H7-EB...	-	8,99 0.3539	8,99 0.3539	9,01 0.3545	46,0 1.8110	10,0 0.3940	78,0 3.0710	6		<input type="checkbox"/>	<input type="checkbox"/>	<input type="checkbox"/>	<input type="checkbox"/>	<input type="checkbox"/>	<input type="checkbox"/>	

Wstęp

Wiercenie

Rozwiercanie

Wytaczanie

Zalącznik

Oznaczenie	Numer produktu	DC	Hole dia min-max			LUX	DMM	OAL		Geometrie			Gatunki		
			mm Cal.	mm Cal.	mm Cal.					mm Cal.	mm Cal.	mm Cal.	mm Cal.	EB45	EB45
NS10-9.00H7-EB...	-	9,0 0.3543	9,00 0.3543	9,02 0.3549	46,0 1.8110	10,0 0.3940	78,0 3.0710	6	<input type="checkbox"/>	<input type="checkbox"/>	<input type="checkbox"/>	<input type="checkbox"/>	<input type="checkbox"/>	<input type="checkbox"/>	<input type="checkbox"/>
NS10-9H7-EB30	10019465	9,0 0.3543	9,02 0.3549	9,00 0.3543	46,0 1.8110	10,0 0.3940	78,0 3.0710	4	<input type="checkbox"/>	<input type="checkbox"/>	<input checked="" type="checkbox"/>	<input checked="" type="checkbox"/>	<input type="checkbox"/>	<input type="checkbox"/>	<input type="checkbox"/>
NS10-9.01H7-EB...	-	9,01 0.3547	9,01 0.3547	9,03 0.3553	46,0 1.8110	10,0 0.3940	78,0 3.0710	6	<input type="checkbox"/>	<input type="checkbox"/>	<input type="checkbox"/>	<input type="checkbox"/>	<input type="checkbox"/>	<input type="checkbox"/>	<input type="checkbox"/>
NS10-9.02H7-EB...	-	9,02 0.3551	9,02 0.3551	9,04 0.3557	46,0 1.8110	10,0 0.3940	78,0 3.0710	6	<input type="checkbox"/>	<input type="checkbox"/>	<input type="checkbox"/>	<input type="checkbox"/>	<input type="checkbox"/>	<input type="checkbox"/>	<input type="checkbox"/>
NS10-9.03H7-EB...	-	9,03 0.3555	9,03 0.3555	9,05 0.3561	46,0 1.8110	10,0 0.3940	78,0 3.0710	6	<input type="checkbox"/>	<input type="checkbox"/>	<input type="checkbox"/>	<input type="checkbox"/>	<input type="checkbox"/>	<input type="checkbox"/>	<input type="checkbox"/>
NS10-9.04H7-EB...	-	9,04 0.3559	9,04 0.3559	9,06 0.3565	46,0 1.8110	10,0 0.3940	78,0 3.0710	6	<input type="checkbox"/>	<input type="checkbox"/>	<input type="checkbox"/>	<input type="checkbox"/>	<input type="checkbox"/>	<input type="checkbox"/>	<input type="checkbox"/>
NS10-9.05H7-EB...	-	9,05 0.3563	9,05 0.3563	9,07 0.3569	46,0 1.8110	10,0 0.3940	78,0 3.0710	6	<input type="checkbox"/>	<input type="checkbox"/>	<input type="checkbox"/>	<input type="checkbox"/>	<input type="checkbox"/>	<input type="checkbox"/>	<input type="checkbox"/>
NS10-9.50H7-EB...	-	9,5 0.3740	9,50 0.3740	9,52 0.3746	46,0 1.8110	10,0 0.3940	78,0 3.0710	6	<input type="checkbox"/>	<input type="checkbox"/>	<input type="checkbox"/>	<input type="checkbox"/>	<input type="checkbox"/>	<input type="checkbox"/>	<input type="checkbox"/>
NS10-9.5123H7-EB...	-	9,5123 0.3745	9,51 0.3745	9,53 0.3751	46,0 1.8110	10,0 0.3940	78,0 3.0710	6	<input type="checkbox"/>	<input type="checkbox"/>	<input type="checkbox"/>	<input type="checkbox"/>	<input type="checkbox"/>	<input type="checkbox"/>	<input type="checkbox"/>
NS10-9.5250H7-EB...	-	9,525 0.3750	9,53 0.3750	9,54 0.3756	46,0 1.8110	10,0 0.3940	78,0 3.0710	6	<input type="checkbox"/>	<input type="checkbox"/>	<input type="checkbox"/>	<input type="checkbox"/>	<input type="checkbox"/>	<input type="checkbox"/>	<input type="checkbox"/>
NS10-9.525H7-EB30	10019466	9,525 0.3750	9,54 0.3756	9,53 0.3750	46,0 1.8110	10,0 0.3940	78,0 3.0710	4	<input type="checkbox"/>	<input type="checkbox"/>	<input checked="" type="checkbox"/>	<input checked="" type="checkbox"/>	<input type="checkbox"/>	<input type="checkbox"/>	<input type="checkbox"/>
NS10-9.97H7-EB...	-	9,97 0.3925	9,97 0.3925	9,99 0.3931	46,0 1.8110	10,0 0.3940	78,0 3.0710	6	<input type="checkbox"/>	<input type="checkbox"/>	<input type="checkbox"/>	<input type="checkbox"/>	<input type="checkbox"/>	<input type="checkbox"/>	<input type="checkbox"/>
NS10-9.98H7-EB...	-	9,98 0.3929	9,98 0.3929	10,00 0.3935	46,0 1.8110	10,0 0.3940	78,0 3.0710	6	<input type="checkbox"/>	<input type="checkbox"/>	<input type="checkbox"/>	<input type="checkbox"/>	<input type="checkbox"/>	<input type="checkbox"/>	<input type="checkbox"/>
NS10-9.99H7-EB...	-	9,99 0.3933	9,99 0.3933	10,01 0.3939	46,0 1.8110	10,0 0.3940	78,0 3.0710	6	<input type="checkbox"/>	<input type="checkbox"/>	<input type="checkbox"/>	<input type="checkbox"/>	<input type="checkbox"/>	<input type="checkbox"/>	<input type="checkbox"/>
NS10-10.00H7-EB...	-	10,0 0.3937	10,00 0.3937	10,02 0.3943	46,0 1.8110	10,0 0.3940	78,0 3.0710	6	<input type="checkbox"/>	<input type="checkbox"/>	<input type="checkbox"/>	<input type="checkbox"/>	<input type="checkbox"/>	<input type="checkbox"/>	<input type="checkbox"/>
NS10-10H7-EB30	10019467	10,0 0.3937	10,02 0.3943	10,00 0.3937	46,0 1.8110	10,0 0.3940	78,0 3.0710	4	<input type="checkbox"/>	<input type="checkbox"/>	<input checked="" type="checkbox"/>	<input checked="" type="checkbox"/>	<input type="checkbox"/>	<input type="checkbox"/>	<input type="checkbox"/>
NS10-10.01H7-EB...	-	10,01 0.3941	10,01 0.3941	10,03 0.3948	46,0 1.8110	10,0 0.3940	78,0 3.0710	6	<input type="checkbox"/>	<input type="checkbox"/>	<input type="checkbox"/>	<input type="checkbox"/>	<input type="checkbox"/>	<input type="checkbox"/>	<input type="checkbox"/>
NS10-10.02H7-EB...	-	10,02 0.3945	10,02 0.3945	10,04 0.3952	46,0 1.8110	10,0 0.3940	78,0 3.0710	6	<input type="checkbox"/>	<input type="checkbox"/>	<input type="checkbox"/>	<input type="checkbox"/>	<input type="checkbox"/>	<input type="checkbox"/>	<input type="checkbox"/>
NS10-10.03H7-EB...	-	10,03 0.3949	10,03 0.3949	10,05 0.3956	46,0 1.8110	10,0 0.3940	78,0 3.0710	6	<input type="checkbox"/>	<input type="checkbox"/>	<input type="checkbox"/>	<input type="checkbox"/>	<input type="checkbox"/>	<input type="checkbox"/>	<input type="checkbox"/>
NS10-10.04H7-EB...	-	10,04 0.3953	10,04 0.3953	10,06 0.3960	46,0 1.8110	10,0 0.3940	78,0 3.0710	6	<input type="checkbox"/>	<input type="checkbox"/>	<input type="checkbox"/>	<input type="checkbox"/>	<input type="checkbox"/>	<input type="checkbox"/>	<input type="checkbox"/>
NS10-10.05H7-EB...	-	10,05 0.3957	10,05 0.3957	10,07 0.3964	46,0 1.8110	10,0 0.3940	78,0 3.0710	6	<input type="checkbox"/>	<input type="checkbox"/>	<input type="checkbox"/>	<input type="checkbox"/>	<input type="checkbox"/>	<input type="checkbox"/>	<input type="checkbox"/>
NS10-10.50H7-EB...	-	10,5 0.4134	10,50 0.4134	10,52 0.4141	57,0 2.2440	10,0 0.3940	88,0 3.4650	6	<input type="checkbox"/>	<input type="checkbox"/>	<input type="checkbox"/>	<input type="checkbox"/>	<input type="checkbox"/>	<input type="checkbox"/>	<input type="checkbox"/>
NS10-10.97H7-EB...	-	10,97 0.4319	10,97 0.4319	10,99 0.4326	57,0 2.2440	10,0 0.3940	88,0 3.4650	6	<input type="checkbox"/>	<input type="checkbox"/>	<input type="checkbox"/>	<input type="checkbox"/>	<input type="checkbox"/>	<input type="checkbox"/>	<input type="checkbox"/>
NS10-10.98H7-EB...	-	10,98 0.4323	10,98 0.4323	11,00 0.4330	57,0 2.2440	10,0 0.3940	88,0 3.4650	6	<input type="checkbox"/>	<input type="checkbox"/>	<input type="checkbox"/>	<input type="checkbox"/>	<input type="checkbox"/>	<input type="checkbox"/>	<input type="checkbox"/>
NS10-10.99H7-EB...	-	10,99 0.4327	10,99 0.4327	11,01 0.4334	57,0 2.2440	10,0 0.3940	88,0 3.4650	6	<input type="checkbox"/>	<input type="checkbox"/>	<input type="checkbox"/>	<input type="checkbox"/>	<input type="checkbox"/>	<input type="checkbox"/>	<input type="checkbox"/>
NS10-11.00H7-EB...	-	11,0 0.4331	11,00 0.4331	11,02 0.4338	57,0 2.2440	10,0 0.3940	88,0 3.4650	6	<input type="checkbox"/>	<input type="checkbox"/>	<input type="checkbox"/>	<input type="checkbox"/>	<input type="checkbox"/>	<input type="checkbox"/>	<input type="checkbox"/>
NS10-11.01H7-EB...	-	11,01 0.4335	11,01 0.4335	11,03 0.4342	57,0 2.2440	10,0 0.3940	88,0 3.4650	6	<input type="checkbox"/>	<input type="checkbox"/>	<input type="checkbox"/>	<input type="checkbox"/>	<input type="checkbox"/>	<input type="checkbox"/>	<input type="checkbox"/>
NS10-11.02H7-EB...	-	11,02 0.4339	11,02 0.4339	11,04 0.4346	57,0 2.2440	10,0 0.3940	88,0 3.4650	6	<input type="checkbox"/>	<input type="checkbox"/>	<input type="checkbox"/>	<input type="checkbox"/>	<input type="checkbox"/>	<input type="checkbox"/>	<input type="checkbox"/>
NS10-11.03H7-EB...	-	11,03 0.4343	11,03 0.4343	11,05 0.4350	57,0 2.2440	10,0 0.3940	88,0 3.4650	6	<input type="checkbox"/>	<input type="checkbox"/>	<input type="checkbox"/>	<input type="checkbox"/>	<input type="checkbox"/>	<input type="checkbox"/>	<input type="checkbox"/>
NS10-11.04H7-EB...	-	11,04 0.4346	11,04 0.4346	11,06 0.4354	57,0 2.2440	10,0 0.3940	88,0 3.4650	6	<input type="checkbox"/>	<input type="checkbox"/>	<input type="checkbox"/>	<input type="checkbox"/>	<input type="checkbox"/>	<input type="checkbox"/>	<input type="checkbox"/>

Wstęp

Wiercenie

Rozwiercanie

Wylaczanie

Załącznik

Oznaczenie	Numer produktu	DC			Hole dia min-max			LUX	DMM	OAL	Geometrie			Gatunki		
		mm Cal.	mm Cal.	mm Cal.	mm Cal.	mm Cal.	mm Cal.				mm Cal.	mm Cal.	mm Cal.	mm Cal.	mm Cal.	mm Cal.
NS10-11.05H7-EB...	-	11,05 0.4350	11,05 0.4350	11,07 0.4357	57,0 2.2440	10,0 0.3940	88,0 3.4650	6		<input type="checkbox"/>	<input type="checkbox"/>	<input type="checkbox"/>	<input type="checkbox"/>	<input type="checkbox"/>	<input type="checkbox"/>	
NS10-11.112H7-EB...	-	11,112 0.4375	11,11 0.4375	11,13 0.4382	57,0 2.2440	10,0 0.3940	88,0 3.4650	6		<input type="checkbox"/>	<input type="checkbox"/>	<input type="checkbox"/>	<input type="checkbox"/>	<input type="checkbox"/>	<input type="checkbox"/>	
NS10-11.50H7-EB...	-	11,5 0.4528	11,50 0.4528	11,52 0.4535	57,0 2.2440	10,0 0.3940	88,0 3.4650	6		<input type="checkbox"/>	<input type="checkbox"/>	<input type="checkbox"/>	<input type="checkbox"/>	<input type="checkbox"/>	<input type="checkbox"/>	
NS10-11.97H7-EB...	-	11,97 0.4713	11,97 0.4713	11,99 0.4720	57,0 2.2440	10,0 0.3940	88,0 3.4650	6		<input type="checkbox"/>	<input type="checkbox"/>	<input type="checkbox"/>	<input type="checkbox"/>	<input type="checkbox"/>	<input type="checkbox"/>	
NS10-11.98H7-EB...	-	11,98 0.4717	11,98 0.4717	12,00 0.4724	57,0 2.2440	10,0 0.3940	88,0 3.4650	6		<input type="checkbox"/>	<input type="checkbox"/>	<input type="checkbox"/>	<input type="checkbox"/>	<input type="checkbox"/>	<input type="checkbox"/>	
NS10-11.99H7-EB...	-	11,99 0.4720	11,99 0.4720	12,01 0.4728	57,0 2.2440	10,0 0.3940	88,0 3.4650	6		<input type="checkbox"/>	<input type="checkbox"/>	<input type="checkbox"/>	<input type="checkbox"/>	<input type="checkbox"/>	<input type="checkbox"/>	
NS10-12.00H7-EB...	-	12,0 0.4724	12,00 0.4724	12,02 0.4731	57,0 2.2440	10,0 0.3940	88,0 3.4650	6		<input type="checkbox"/>	<input type="checkbox"/>	<input type="checkbox"/>	<input type="checkbox"/>	<input type="checkbox"/>	<input type="checkbox"/>	
NS10-12H7-EB30	10019468	12,0 0.4724	12,02 0.4731	12,00 0.4724	57,0 2.2440	10,0 0.3940	88,0 3.4650	4		<input type="checkbox"/>	<input type="checkbox"/>	<input checked="" type="checkbox"/>	<input checked="" type="checkbox"/>	<input type="checkbox"/>	<input type="checkbox"/>	
NS10-12.01H7-EB...	-	12,01 0.4728	12,01 0.4728	12,03 0.4735	57,0 2.2440	10,0 0.3940	88,0 3.4650	6		<input type="checkbox"/>	<input type="checkbox"/>	<input type="checkbox"/>	<input type="checkbox"/>	<input type="checkbox"/>	<input type="checkbox"/>	
NS10-12.02H7-EB...	-	12,02 0.4732	12,02 0.4732	12,04 0.4739	57,0 2.2440	10,0 0.3940	88,0 3.4650	6		<input type="checkbox"/>	<input type="checkbox"/>	<input type="checkbox"/>	<input type="checkbox"/>	<input type="checkbox"/>	<input type="checkbox"/>	
NS10-12.03H7-EB...	-	12,03 0.4736	12,03 0.4736	12,05 0.4743	57,0 2.2440	10,0 0.3940	88,0 3.4650	6		<input type="checkbox"/>	<input type="checkbox"/>	<input type="checkbox"/>	<input type="checkbox"/>	<input type="checkbox"/>	<input type="checkbox"/>	
NS10-12.04H7-EB...	-	12,04 0.4740	12,04 0.4740	12,06 0.4747	57,0 2.2440	10,0 0.3940	88,0 3.4650	6		<input type="checkbox"/>	<input type="checkbox"/>	<input type="checkbox"/>	<input type="checkbox"/>	<input type="checkbox"/>	<input type="checkbox"/>	
NS10-12.05H7-EB...	-	12,05 0.4744	12,05 0.4744	12,07 0.4751	57,0 2.2440	10,0 0.3940	88,0 3.4650	6		<input type="checkbox"/>	<input type="checkbox"/>	<input type="checkbox"/>	<input type="checkbox"/>	<input type="checkbox"/>	<input type="checkbox"/>	

■ Wyrób standardowy. □ Standard niemagazynowany.

Uwaga: Przy zamawianiu rozwiertaka Nanofix dla średnic pośrednich należy podać średnicę i tolerancję rozwiercanego otworu.

Przykładowe zamówienie: NS10-10.187/10.213-EB845, RX2000.

Wstęp

Wiercenie

Rozwiercanie

Wytaczanie

Załącznik

Średnice pośrednie

Ostrza proste, wersja krótka, do otworów przelotowych i nieprzelotowych

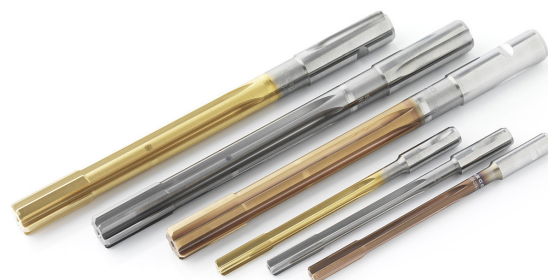
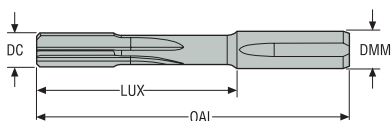

- Wybór geometrii, patrz str. 369-371
- Parametry skrawania, patrz strona (strony) 389-396

Oznaczenie	DCN	DCX	LUX	DMM	OAL	Wielkość korpusu	Geometrie	Gatunki							
	mm Cal.	mm Cal.	mm Cal.	mm Cal.	mm Cal.				H15	RK2050	RX2000	RN2010	RM2020	RM2090	RS2090
NS06-2.970-XX-XXXX	2,97 0.117	3,05 0.120	25,0 0.120	6,0 0.236	45,0 1.772	4	NFQF06-xx	EB45 EB845 EB30	<input type="checkbox"/>	<input type="checkbox"/>	<input type="checkbox"/>	<input type="checkbox"/>	<input type="checkbox"/>	<input type="checkbox"/>	<input type="checkbox"/>
NS06-3.051-XX-XXXX	3,051 0.120	6,05 0.238	30,0 0.238	6,0 0.236	50,0 1.969	4	NFQF06-xx	EB45 EB845 EB30	<input type="checkbox"/>	<input type="checkbox"/>	<input type="checkbox"/>	<input type="checkbox"/>	<input type="checkbox"/>	<input type="checkbox"/>	<input type="checkbox"/>
NS10-6.051-XX-XXXX	6,051 0.238	10,05 0.396	46,0 0.396	10,0 0.394	78,0 3.071	6	NFQF10-xx	EB45 EB845 EB30	<input type="checkbox"/>	<input type="checkbox"/>	<input type="checkbox"/>	<input type="checkbox"/>	<input type="checkbox"/>	<input type="checkbox"/>	<input type="checkbox"/>
NS10-10.051-XX-XXXX	10,051 0.396	12,05 0.474	57,0 0.474	10,0 0.394	88,0 3.465	6	NFQF10-xx	EB45 EB845 EB30	<input type="checkbox"/>	<input type="checkbox"/>	<input type="checkbox"/>	<input type="checkbox"/>	<input type="checkbox"/>	<input type="checkbox"/>	<input type="checkbox"/>

= Pozycja niestandardowa.

Uwaga: Przy zamawianiu rozwiertaka Nanofix dla średnic pośrednich należy podać średnicę i tolerancję rozwiercanego otworu.

Przykładowe zamówienie: NS06-5.187/5.213-EB845, RX2000.

Średnice pośrednie

Lewa linia śrubowa, wersja krótka, do otworów przelotowych

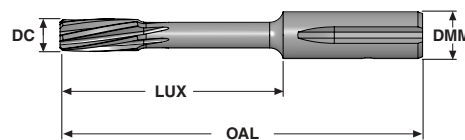
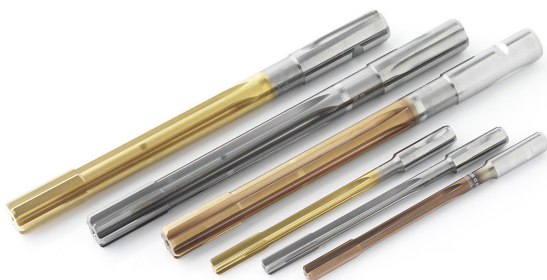

- Wybór geometrii, patrz str. 369-371
- Parametry skrawania, patrz strona (strony) 389-396

Oznaczenie	DCN	DCX	LUX	DMM	OAL	Wielkość korpusu	Geometrie	Gatunki							
	mm Cal.	mm Cal.						H15	RK2050	RX2000	RN2010	RM2020	RM2090	RS2090	
NS6-2.970-XX-XXXX	2,97 0.117	3,05 0.120	25,0 0.984	6,0 0.236	45,0 1.772	4	NFQF06-xx	EB45 EB845 EB30	<input type="checkbox"/>	<input type="checkbox"/>	<input type="checkbox"/>	<input type="checkbox"/>	<input type="checkbox"/>	<input type="checkbox"/>	<input type="checkbox"/>
NS6-3.051-XX-XXXX	3,051 0.120	6,05 0.238	30,0 1.181	6,0 0.236	50,0 1.969	4	NFQF06-xx	EB45 EB845 EB30	<input type="checkbox"/>	<input type="checkbox"/>	<input type="checkbox"/>	<input type="checkbox"/>	<input type="checkbox"/>	<input type="checkbox"/>	<input type="checkbox"/>
NS6-6.051-XX-XXXX	6,051 0.238	8,05 0.317	46,0 1.811	10,0 0.394	78,0 3.071	6	NFQF10-xx	EB45 EB845 EB30	<input type="checkbox"/>	<input type="checkbox"/>	<input type="checkbox"/>	<input type="checkbox"/>	<input type="checkbox"/>	<input type="checkbox"/>	<input type="checkbox"/>
NS6-10.051-XX-XXXX	10,051 0.396	12,05 0.474	57,0 2.244	10,0 0.394	88,0 3.465	6	NFQF10-xx	EB45 EB845 EB30	<input type="checkbox"/>	<input type="checkbox"/>	<input type="checkbox"/>	<input type="checkbox"/>	<input type="checkbox"/>	<input type="checkbox"/>	<input type="checkbox"/>

= Pozycja niestandardowa.

Uwaga: Przy zamawianiu rozwiertaka Nanofix dla średnic pośrednich należy podać średnicę i tolerancję rozwiercanego otworu.

Przykładowe zamówienie: NS6-5.187/5.213-EB845, RX2000.

Średnice pośrednie

Prawa linia śrubowa, wersja krótka, do otworów nieprzelotowych

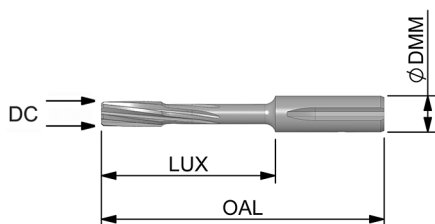

- Wybór geometrii, patrz str. 369-371
- Parametry skrawania, patrz strona (strony) 389-396

Oznaczenie	DCN	DCX	LUX	DMM	OAL	Wielkość korpusu	Geometrie	Gatunki							
	mm Cal.	mm Cal.	mm Cal.	mm Cal.	mm Cal.				H15	RK2050	RX2000	RN2010	RM2020	RM2090	RS2090
NS4-2.970-XX-XXXX	2,97 0.117	3,05 0.120	25,0 0.984	6,0 0.236	45,0 1.772	4	NFQF06-xx	EB45 EB845	<input type="checkbox"/>	<input type="checkbox"/>	<input type="checkbox"/>	<input type="checkbox"/>	<input type="checkbox"/>	<input type="checkbox"/>	<input type="checkbox"/>
NS4-3.051-XX-XXXX	3,051 0.120	6,05 0.238	30,0 1.181	6,0 0.236	50,0 1.969	4	NFQF06-xx	EB45 EB845	<input type="checkbox"/>	<input type="checkbox"/>	<input type="checkbox"/>	<input type="checkbox"/>	<input type="checkbox"/>	<input type="checkbox"/>	<input type="checkbox"/>
NS4-4.051-XX-XXXX	6,051 0.238	8,05 0.317	46,0 1.811	10,0 0.394	78,0 3.071	6	NFQF10-xx	EB45 EB845	<input type="checkbox"/>	<input type="checkbox"/>	<input type="checkbox"/>	<input type="checkbox"/>	<input type="checkbox"/>	<input type="checkbox"/>	<input type="checkbox"/>
NS4-10.051-XX-XXXX	10,051 0.396	12,05 0.474	57,0 2.244	10,0 0.394	88,0 3.465	6	NFQF10-xx	EB45 EB845	<input type="checkbox"/>	<input type="checkbox"/>	<input type="checkbox"/>	<input type="checkbox"/>	<input type="checkbox"/>	<input type="checkbox"/>	<input type="checkbox"/>

= Pozycja niestandardowa.

Uwaga: Przy zamawianiu rozwiertaka Nanofix dla średnic pośrednich należy podać średnicę i tolerancję rozwiercanego otworu.

Przykładowe zamówienie: NS4-10.187/10.213-EB845, RX2000.

Oprawka Nanofix

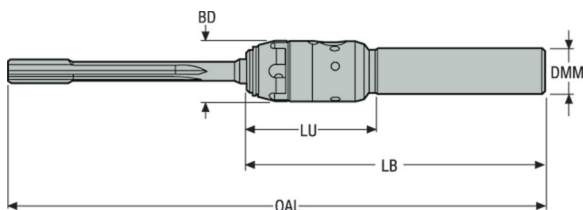

Numer produktu	Oznaczenie	DC	DMM	BD	LU	LB
		mm	mm	mm	mm	mm
02729036	NFQF06-03700-10N1	2,97-6,05	10,0	16,0	37,0	80,0
02729037	NFQF06-03300-12N1	2,97-6,05	12,0	16,0	35,0	80,0
02729041	NFQF06-03000-16N1	2,97-6,05	16,0	16,0	30,0	80,0
02729044	NFQF10-05200-12N1	6,051-12,05	12,0	23,0	52,0	100,0
02729045	NFQF10-04900-16N1	6,051-12,05	16,0	23,0	49,0	100,0
02729046	NFQF10-04700-20N1	6,051-12,05	20,0	23,0	47,0	100,0

	Długość standardowa	Długość krótka
DC	OAL	OAL
2,970-3,050 mm (0.1169-0.1200")	124,5 mm (4.902")	109,5 mm (4.311")
3,051-6,050 mm (0.1201-0.2382")	144,5 mm (5.689")	113,5 mm (4.469")
6,051-8,050 mm (0.2383-0.3169")	189,5 mm (7.461")	149,5 mm (5.886")
8,051-10,050 mm (0.3170-0.3956")	199,5 mm (7.854")	152,5 mm (6.004")
10,051-12,050 mm (0.3957-0.4744")	219,5 mm (8.642")	162,5 mm (6.398")

Części zamienne, zawarte w dostawie

DC	Zapasyowy zestaw mocujący	Klucz
2,97-6,050	NF06-CLKI	CLC06KEY
6,051-12,050	NF10-CLKI	CLC10KEY

Zapasyowy zestaw mocujący do uchwytów Nanofix zawiera:

- 1 nakrętka mocująca
- 1 oporowy pierścień sprężynowy
- 3 kulki mocujące (średnica 3,5 mm dla wielkości NF06 i średnica 5 mm dla wielkości NF10)
- 1 kula zabezpieczająca (średnica 3 mm dla wielkości NF06 i średnica 4 mm dla wielkości NF10)
- 1 pierścień o-ring

Uwaga: Kula zabezpieczająca nie pokazana na powyższym rysunku.

Parametry skrawania – NF/NS...EB45 Metryczne

SMG		a _p (°)		f		v _c							
		z=4	z=6	z=4	z=6	H15	CP20	RX2000	RK2050	RN2010	RM2020	RM2090	RS2090
P1	NF/NS-EB45	0,10-0,15	0,1-0,20	0,10-0,30	0,20-0,60	25 (15-30)	60 (30-100)	80 (30-150)	-	-	-	-	-
P2	NF/NS-EB45	0,10-0,15	0,1-0,20	0,10-0,30	0,20-0,60	25 (15-30)	60 (30-100)	80 (30-150)	-	-	-	-	-
P3	NF/NS-EB45	0,10-0,15	0,1-0,20	0,10-0,30	0,20-0,60	25 (15-30)	60 (30-100)	80 (30-150)	-	-	-	-	-
P4	NF/NS-EB45	0,10-0,15	0,1-0,20	0,10-0,20	0,20-0,50	20 (10-25)	50 (30-80)	60 (30-120)	-	-	-	-	-
P5	NF/NS-EB45	0,10-0,15	0,1-0,20	0,10-0,20	0,20-0,50	20 (10-25)	50 (30-80)	60 (30-120)	-	-	-	-	-
P6	NF/NS-EB45	0,10-0,15	0,1-0,20	0,10-0,20	0,20-0,50	20 (10-25)	50 (30-80)	60 (30-120)	-	-	-	-	-
P7	NF/NS-EB45	0,10-0,15	0,1-0,20	0,10-0,20	0,20-0,50	20 (10-25)	50 (30-80)	60 (30-120)	-	-	-	-	-
P8	NF/NS-EB45	0,10-0,15	0,1-0,20	0,10-0,20	0,20-0,50	15 (10-20)	35 (20-60)	40 (20-80)	-	-	-	-	-
P11	NF/NS-EB45	0,10-0,15	0,1-0,20	0,10-0,20	0,20-0,50	15 (10-20)	35 (20-60)	40 (20-80)	-	-	-	-	-
P12	NF/NS-EB45	0,10-0,15	0,1-0,20	0,10-0,20	0,20-0,50	12 (8-15)	25 (15-45)	30 (15-65)	-	-	-	-	-
M1	NF/NS-EB45	0,08-0,15	0,10-0,15	0,10-0,20	0,20-0,50	12 (9-15)	25 (15-40)	35 (20-60)	-	-	25 (15-40)	40 (20-60)	-
M2	NF/NS-EB45	0,08-0,15	0,10-0,15	0,10-0,20	0,20-0,50	-	25 (15-40)	35 (20-60)	-	-	25 (15-40)	40 (20-60)	-
M3	NF/NS-EB45	0,08-0,15	0,10-0,15	0,10-0,20	0,20-0,50	-	25 (15-40)	35 (20-60)	-	-	25 (15-40)	40 (20-60)	-
M4	NF/NS-EB45	0,08-0,15	0,10-0,15	0,10-0,20	0,20-0,50	-	20 (10-30)	25 (15-40)	-	-	25 (10-30)	30 (15-40)	-
M5	NF/NS-EB45	0,08-0,15	0,10-0,15	0,10-0,20	0,20-0,50	-	20 (10-30)	25 (15-40)	-	-	25 (10-30)	30 (15-40)	-
K1	NF/NS-EB45	0,10-0,20	0,10-0,25	0,10-0,30	0,20-0,60	25 (15-30)	60 (40-100)	80 (30-150)	90 (35-170)	-	-	-	-
K2	NF/NS-EB45	0,10-0,20	0,10-0,25	0,10-0,30	0,20-0,60	-	25 (20-40)	40 (30-70)	45 (35-80)	-	-	-	-
K3	NF/NS-EB45	0,10-0,20	0,10-0,25	0,10-0,30	0,20-0,60	25 (15-30)	60 (40-100)	80 (30-150)	90 (35-170)	-	-	-	-
K4	NF/NS-EB45	0,10-0,20	0,10-0,25	0,10-0,30	0,20-0,60	25 (15-30)	45 (30-70)	70 (40-120)	80 (45-135)	-	-	-	-
K5	NF/NS-EB45	0,10-0,20	0,10-0,25	0,10-0,30	0,20-0,60	25 (15-30)	45 (30-70)	70 (40-120)	80 (45-135)	-	-	-	-
K6	NF/NS-EB45	0,10-0,20	0,10-0,25	0,10-0,30	0,20-0,60	-	60 (40-100)	80 (30-150)	90 (35-170)	-	-	-	-
K7	NF/NS-EB45	0,10-0,20	0,10-0,25	0,10-0,30	0,20-0,60	-	60 (40-100)	80 (30-150)	90 (35-170)	-	-	-	-
N1	NF/NS-EB45	0,10-0,20	0,10-0,30	0,10-0,30	0,20-0,60	50 (20-80)	-	80 (30-150)	-	50 (20-80)	-	-	-
N2	NF/NS-EB45	0,10-0,20	0,10-0,30	0,10-0,30	0,20-0,60	50 (20-80)	-	80 (30-150)	-	50 (20-80)	-	-	-
N3	NF/NS-EB45	0,10-0,20	0,10-0,30	0,10-0,30	0,20-0,60	50 (20-80)	-	80 (30-150)	-	50 (20-80)	-	-	-
N4	NF/NS-EB45	0,10-0,20	0,10-0,30	0,10-0,30	0,20-0,60	50 (20-80)	-	80 (30-150)	-	50 (20-80)	-	-	-
S1	NF/NS-EB45	0,08-0,15	0,10-0,15	0,10-0,20	0,20-0,30	-	15 (8-20)	20 (10-25)	-	-	-	-	20 (10-25)
S2	NF/NS-EB45	0,08-0,15	0,10-0,15	0,10-0,20	0,20-0,30	-	15 (8-20)	20 (10-25)	-	-	-	-	20 (10-25)
S3	NF/NS-EB45	0,08-0,15	0,10-0,15	0,10-0,20	0,20-0,30	-	15 (8-20)	20 (10-25)	-	-	-	-	25 (10-25)
S11	NF/NS-EB45	0,08-0,15	0,10-0,15	0,10-0,20	0,20-0,30	20 (15-30)	30 (15-40)	40 (20-50)	-	-	-	-	30 (20-50)
S12	NF/NS-EB45	0,08-0,15	0,10-0,15	0,10-0,20	0,20-0,30	20 (15-30)	30 (15-40)	40 (20-50)	-	-	-	-	30 (20-50)
S13	NF/NS-EB45	0,08-0,15	0,10-0,15	0,10-0,20	0,20-0,30	20 (15-30)	30 (15-40)	40 (20-50)	-	-	-	-	30 (20-50)

Tabela jest kontynuowana na następnej stronie.

Wstęp

Wiercenie

Rozwiercanie

Wylaczanie

Zalacznik

Parametry skrawania – NF/NS...-EB45 Metryczne

SMG		$a_p (\varnothing)$		f		v_c							
		z=4	z=6	z=4	z=6	H15	CP20	RX2000	RK2050	RN2010	RM2020	RM2090	RS2090
H3	NF/NS-EB45	0,08-0,15	0,10-0,15	0,10-0,20	0,20-0,30	-	-	10 (8-15)	-	-	-	-	-
H5	NF/NS-EB45	0,08-0,15	0,10-0,15	0,10-0,20	0,20-0,30	-	-	10 (8-15)	-	-	-	-	-
H7	NF/NS-EB45	0,08-0,15	0,10-0,15	0,10-0,20	0,20-0,30	-	-	10 (8-15)	-	-	-	-	-
H8	NF/NS-EB45	0,08-0,15	0,10-0,15	0,10-0,20	0,20-0,30	-	-	10 (8-15)	-	-	-	-	-
H11	NF/NS-EB45	0,08-0,15	0,10-0,15	0,10-0,20	0,20-0,30	-	-	10 (8-15)	-	-	-	-	-
H12	NF/NS-EB45	0,08-0,15	0,10-0,15	0,10-0,20	0,20-0,30	-	-	10 (8-15)	-	-	-	-	-
H21	NF/NS-EB45	0,08-0,15	0,10-0,15	0,10-0,20	0,20-0,30	-	-	10 (8-15)	-	-	-	-	-
H31	NF/NS-EB45	0,08-0,15	0,10-0,15	0,10-0,20	0,20-0,30	-	-	10 (8-15)	-	-	-	-	-
PM1	NF/NS-EB45	0,10-0,15	0,1-0,20	0,10-0,20	0,20-0,50	-	50 (30-80)	70 (40-100)	-	-	-	-	-
PM2	NF/NS-EB45	0,10-0,15	0,1-0,20	0,10-0,20	0,20-0,50	-	50 (30-80)	70 (40-100)	-	-	-	-	-
PM3	NF/NS-EB45	0,10-0,15	0,1-0,20	0,10-0,20	0,20-0,50	-	50 (30-80)	70 (40-100)	-	-	-	-	-
TS1	NF/NS-EB45	0,10-0,15	0,1-0,20	0,10-0,30	0,20-0,60	20 (15-25)	-	40 (20-60)	-	-	-	-	-
TS2	NF/NS-EB45	0,10-0,15	0,1-0,20	0,10-0,30	0,20-0,60	20 (15-25)	-	40 (20-60)	-	-	-	-	-
TS3	NF/NS-EB45	0,10-0,15	0,1-0,20	0,10-0,30	0,20-0,60	20 (15-25)	-	40 (20-60)	-	-	-	-	-
TS4	NF/NS-EB45	0,10-0,15	0,1-0,20	0,10-0,30	0,20-0,60	20 (15-25)	-	40 (20-60)	-	-	-	-	-
TP1	NF/NS-EB45	0,10-0,15	0,1-0,20	0,10-0,30	0,20-0,60	20 (15-25)	-	40 (20-60)	-	-	-	-	-
TP2	NF/NS-EB45	0,10-0,15	0,1-0,20	0,10-0,30	0,20-0,60	20 (15-25)	-	40 (20-60)	-	-	-	-	-
TP3	NF/NS-EB45	0,10-0,15	0,1-0,20	0,10-0,30	0,20-0,60	20 (15-25)	-	40 (20-60)	-	-	-	-	-
TP4	NF/NS-EB45	0,10-0,15	0,1-0,20	0,10-0,30	0,20-0,60	20 (15-25)	-	40 (20-60)	-	-	-	-	-
GR1	NF/NS-EB45	0,10-0,15	0,1-0,20	0,10-0,30	0,20-0,60	40 (80-20)	-	60 (30-120)	-	-	-	-	-

SMG = Grupy materiałowe Seco

a_p = mm

f = mm/obr

v_c = m/min

Wszystkie parametry są wartościami początkowymi

Wstęp

Wiercenie

Rozwiercanie

Wytaczanie

Załącznik

Parametry skrawania – NF/NS...EB45 cale

SMG		a _p (∅)		f		v _c							
		z=4	z=6	z=4	z=6	H15	CP20	RX2000	RK2050	RN2010	RM2020	RM2090	RS2090
P1	NF/NS-EB45	0.004-0.006	0.004-0.008	0.004-0.012	0.008-0.024	80 (50-100)	195 (100-330)	260 (100-490)	-	-	-	-	-
P2	NF/NS-EB45	0.004-0.006	0.004-0.008	0.004-0.012	0.008-0.024	80 (50-100)	195 (100-330)	260 (100-490)	-	-	-	-	-
P3	NF/NS-EB45	0.004-0.006	0.004-0.008	0.004-0.012	0.008-0.024	80 (50-100)	195 (100-330)	260 (100-490)	-	-	-	-	-
P4	NF/NS-EB45	0.004-0.006	0.004-0.008	0.004-0.008	0.008-0.020	65 (35-80)	165 (100-260)	195 (100-395)	-	-	-	-	-
P5	NF/NS-EB45	0.004-0.006	0.004-0.008	0.004-0.008	0.008-0.020	65 (35-80)	165 (100-260)	195 (100-395)	-	-	-	-	-
P6	NF/NS-EB45	0.004-0.006	0.004-0.008	0.004-0.008	0.008-0.020	65 (35-80)	165 (100-260)	195 (100-395)	-	-	-	-	-
P7	NF/NS-EB45	0.004-0.006	0.004-0.008	0.004-0.008	0.008-0.020	65 (35-80)	165 (100-260)	195 (100-395)	-	-	-	-	-
P8	NF/NS-EB45	0.004-0.006	0.004-0.008	0.004-0.008	0.008-0.020	50 (35-65)	115 (65-195)	130 (65-260)	-	-	-	-	-
P11	NF/NS-EB45	0.004-0.006	0.004-0.008	0.004-0.008	0.008-0.020	50 (35-65)	115 (65-195)	130 (65-260)	-	-	-	-	-
P12	NF/NS-EB45	0.004-0.006	0.004-0.008	0.004-0.008	0.008-0.020	40 (25-50)	80 (50-150)	100 (50-215)	-	-	-	-	-
M1	NF/NS-EB45	0.003-0.006	0.004-0.006	0.004-0.008	0.008-0.020	40 (30-50)	80 (50-130)	115 (65-195)	-	-	80 (50-130)	130 (65-195)	-
M2	NF/NS-EB45	0.003-0.006	0.004-0.006	0.004-0.008	0.008-0.020	-	80 (50-130)	115 (65-195)	-	-	80 (50-130)	130 (65-195)	-
M3	NF/NS-EB45	0.003-0.006	0.004-0.006	0.004-0.008	0.008-0.020	-	80 (50-130)	115 (65-195)	-	-	80 (50-130)	130 (65-195)	-
M4	NF/NS-EB45	0.003-0.006	0.004-0.006	0.004-0.008	0.008-0.020	-	65 (35-100)	80 (50-130)	-	-	65 (35-100)	100 (50-130)	-
M5	NF/NS-EB45	0.003-0.006	0.004-0.006	0.004-0.008	0.008-0.020	-	65 (35-100)	80 (50-130)	-	-	65 (35-100)	100 (50-130)	-
K1	NF/NS-EB45	0.004-0.008	0.004-0.010	0.004-0.012	0.008-0.024	80 (50-100)	195 (130-330)	260 (100-490)	290 (110-550)	-	-	-	-
K2	NF/NS-EB45	0.004-0.008	0.004-0.010	0.004-0.012	0.008-0.024	-	80 (65-130)	130 (100-230)	145 (110-260)	-	-	-	-
K3	NF/NS-EB45	0.004-0.008	0.004-0.010	0.004-0.012	0.008-0.024	80 (50-100)	195 (130-330)	260 (100-490)	290 (110-550)	-	-	-	-
K4	NF/NS-EB45	0.004-0.008	0.004-0.010	0.004-0.012	0.008-0.024	80 (50-100)	150 (100-230)	230 (130-395)	260 (145-440)	-	-	-	-
K5	NF/NS-EB45	0.004-0.008	0.004-0.010	0.004-0.012	0.008-0.024	80 (50-100)	150 (100-230)	230 (130-395)	260 (145-440)	-	-	-	-
K6	NF/NS-EB45	0.004-0.008	0.004-0.010	0.004-0.012	0.008-0.024	-	195 (130-330)	260 (100-490)	290 (110-550)	-	-	-	-
K7	NF/NS-EB45	0.004-0.008	0.004-0.010	0.004-0.012	0.008-0.024	-	195 (130-330)	260 (100-490)	290 (110-550)	-	-	-	-
N1	NF/NS-EB45	0.004-0.787	0.004-0.012	0.004-0.012	0.008-0.024	165 (65-260)	-	260 (100-490)	-	165 (65-260)	-	-	-
N2	NF/NS-EB45	0.004-0.787	0.004-0.012	0.004-0.012	0.008-0.024	165 (65-260)	-	260 (100-490)	-	165 (65-260)	-	-	-
N3	NF/NS-EB45	0.004-0.787	0.004-0.012	0.004-0.012	0.008-0.024	165 (65-260)	-	260 (100-490)	-	165 (65-260)	-	-	-
N4	NF/NS-EB45	0.004-0.787	0.004-0.012	0.004-0.012	0.008-0.024	165 (65-260)	-	260 (100-490)	-	165 (65-260)	-	-	-
S1	NF/NS-EB45	0.003-0.006	0.004-0.006	0.004-0.008	0.008-0.012	-	50 (25-65)	65 (35-80)	-	-	-	-	65 (35-80)
S2	NF/NS-EB45	0.003-0.006	0.004-0.006	0.004-0.008	0.008-0.012	-	50 (25-65)	65 (35-80)	-	-	-	-	65 (35-80)
S3	NF/NS-EB45	0.003-0.006	0.004-0.006	0.004-0.008	0.008-0.012	-	50 (25-65)	65 (35-80)	-	-	-	-	80 (35-80)
S11	NF/NS-EB45	0.003-0.006	0.004-0.006	0.004-0.008	0.008-0.012	65 (50-100)	100 (50-130)	130 (65-165)	-	-	-	-	100 (65-165)
S12	NF/NS-EB45	0.003-0.006	0.004-0.006	0.004-0.008	0.008-0.012	65 (50-100)	100 (50-130)	130 (65-165)	-	-	-	-	100 (65-165)
S13	NF/NS-EB45	0.003-0.006	0.004-0.006	0.004-0.008	0.008-0.012	65 (50-100)	100 (50-130)	130 (65-165)	-	-	-	-	100 (65-165)

Tabela jest kontynuowana na następnej stronie.

Wstęp

Wiercenie

Rozwiercanie

Wylaczanie

Zalacznik

Parametry skrawania – NF/NS...-EB45 cale

SMG		a _p (∅)		f		v _c							
		z=4	z=6	z=4	z=6	H15	CP20	RX2000	RK2050	RN2010	RM2020	RM2090	RS2090
H3	NF/NS-EB45	0.003-0.006	0.004-0.006	0.004-0.008	0.008-0.012	-	-	35 (25-50)	-	-	-	-	-
H5	NF/NS-EB45	0.003-0.006	0.004-0.006	0.004-0.008	0.008-0.012	-	-	35 (25-50)	-	-	-	-	-
H7	NF/NS-EB45	0.003-0.006	0.004-0.006	0.004-0.008	0.008-0.012	-	-	35 (25-50)	-	-	-	-	-
H8	NF/NS-EB45	0.003-0.006	0.004-0.006	0.004-0.008	0.008-0.012	-	-	35 (25-50)	-	-	-	-	-
H11	NF/NS-EB45	0.003-0.006	0.004-0.006	0.004-0.008	0.008-0.012	-	-	35 (25-50)	-	-	-	-	-
H12	NF/NS-EB45	0.003-0.006	0.004-0.006	0.004-0.008	0.008-0.012	-	-	35 (25-50)	-	-	-	-	-
H21	NF/NS-EB45	0.003-0.006	0.004-0.006	0.004-0.008	0.008-0.012	-	-	35 (25-50)	-	-	-	-	-
H31	NF/NS-EB45	0.003-0.006	0.004-0.006	0.004-0.008	0.008-0.012	-	-	35 (25-50)	-	-	-	-	-
PM1	NF/NS-EB45	0.004-0.006	0.004-0.008	0.004-0.008	0.008-0.020	-	165 (100-260)	230 (130-350)	-	-	-	-	-
PM2	NF/NS-EB45	0.004-0.006	0.004-0.008	0.004-0.008	0.008-0.020	-	165 (100-260)	230 (130-350)	-	-	-	-	-
PM3	NF/NS-EB45	0.004-0.006	0.004-0.008	0.004-0.008	0.008-0.020	-	165 (100-260)	230 (130-350)	-	-	-	-	-
TS1	NF/NS-EB45	0.004-0.006	0.004-0.008	0.004-0.012	0.008-0.024	65 (50-80)	-	130 (65-195)	-	-	-	-	-
TS2	NF/NS-EB45	0.004-0.006	0.004-0.008	0.004-0.012	0.008-0.024	65 (50-80)	-	130 (65-195)	-	-	-	-	-
TS3	NF/NS-EB45	0.004-0.006	0.004-0.008	0.004-0.012	0.008-0.024	65 (50-80)	-	130 (65-195)	-	-	-	-	-
TS4	NF/NS-EB45	0.004-0.006	0.004-0.008	0.004-0.012	0.008-0.024	65 (50-80)	-	130 (65-195)	-	-	-	-	-
TP1	NF/NS-EB45	0.004-0.006	0.004-0.008	0.004-0.012	0.008-0.024	65 (50-80)	-	130 (65-195)	-	-	-	-	-
TP2	NF/NS-EB45	0.004-0.006	0.004-0.008	0.004-0.012	0.008-0.024	65 (50-80)	-	130 (65-195)	-	-	-	-	-
TP3	NF/NS-EB45	0.004-0.006	0.004-0.008	0.004-0.012	0.008-0.024	65 (50-80)	-	130 (65-195)	-	-	-	-	-
TP4	NF/NS-EB45	0.004-0.006	0.004-0.008	0.004-0.012	0.008-0.024	65 (50-80)	-	130 (65-195)	-	-	-	-	-
GR1	NF/NS-EB45	0.004-0.006	0.004-0.008	0.004-0.012	0.008-0.024	130 (65-260)	-	195 (100-395)	-	-	-	-	-

SMG = Grupy materiałowe Seco

a_p = calowe

f = cal/obr.

v_c = stp/min

Wszystkie parametry są wartościami początkowymi

Wstęp

Wiercenie

Rozwiercanie

Wytaczanie

Załącznik

Parametry skrawania – NF/NS...-EB845 Metryczne

SMG		a _p (°)		f		v _c						
		z=4	z=6	z=4	z=6	H15	CP20	RX2000	RK2050	RM2020	RM2090	RS2090
P3	NF/NS-EB845	0,10 -0,15	0,1 -0,20	0,10 -0,30	0,20 -0,60	-	60 (30-100)	80 (30-150)	-	-	-	-
P4	NF/NS-EB845	0,10 -0,15	0,1 -0,20	0,10 -0,20	0,20 -0,50	-	50 (30-80)	60 (30-120)	-	-	-	-
P5	NF/NS-EB845	0,10 -0,15	0,1 -0,20	0,10 -0,20	0,20 -0,50	20 (10-25)	50 (30-80)	60 (30-120)	-	-	-	-
P6	NF/NS-EB845	0,10 -0,15	0,1 -0,20	0,10 -0,20	0,20 -0,50	20 (10-25)	50 (30-80)	60 (30-120)	-	-	-	-
P7	NF/NS-EB845	0,10 -0,15	0,1 -0,20	0,10 -0,20	0,20 -0,50	20 (10-25)	50 (30-80)	60 (30-120)	-	-	-	-
P8	NF/NS-EB845	0,10 -0,15	0,1 -0,20	0,10 -0,20	0,20 -0,50	15 (10-20)	35 (20-60)	40 (20-80)	-	-	-	-
P11	NF/NS-EB845	0,10 -0,15	0,1 -0,20	0,10 -0,20	0,20 -0,50	15 (10-20)	35 (20-60)	40 (20-80)	-	-	-	-
P12	NF/NS-EB845	0,10 -0,15	0,1 -0,20	0,10 -0,20	0,20 -0,50	12 (8-15)	25 (15-45)	30 (15-65)	-	-	-	-
M1	NF/NS-EB845	0,08 -0,15	0,10 -0,15	0,10 -0,20	0,20 -0,50	12 (9-15)	25 (15-45)	35 (20-60)	-	25 (15-40)	40 (20-60)	-
M2	NF/NS-EB845	0,08 -0,15	0,10 -0,15	0,10 -0,20	0,20 -0,50	-	25 (15-45)	35 (20-60)	-	25 (15-40)	40 (20-60)	-
M3	NF/NS-EB845	0,08 -0,15	0,10 -0,15	0,10 -0,20	0,20 -0,50	-	25 (15-45)	35 (20-60)	-	25 (15-40)	40 (20-60)	-
M4	NF/NS-EB845	0,08 -0,15	0,10 -0,15	0,10 -0,20	0,20 -0,50	-	20 (10-30)	25 (15-40)	-	25 (10-30)	30 (15-40)	-
M5	NF/NS-EB845	0,08 -0,15	0,10 -0,15	0,10 -0,20	0,20 -0,50	-	20 (10-30)	25 (15-40)	-	25 (10-30)	30 (15-40)	-
K1	NF/NS-EB845	0,10 -0,20	0,10 -0,25	0,10 -0,30	0,20 -0,60	25 (15-30)	60 (40-100)	80 (30-150)	90 (35-170)	-	-	-
K2	NF/NS-EB845	0,10 -0,20	0,10 -0,25	0,10 -0,30	0,20 -0,60	-	25 (20-40)	40 (30-70)	45 (35-80)	-	-	-
K3	NF/NS-EB845	0,10 -0,20	0,10 -0,25	0,10 -0,30	0,20 -0,60	25 (15-30)	60 (40-100)	80 (30-150)	90 (35-170)	-	-	-
K4	NF/NS-EB845	0,10 -0,20	0,10 -0,25	0,10 -0,30	0,20 -0,60	25 (15-30)	45 (30-70)	70 (40-120)	80 (30-150)	-	-	-
K5	NF/NS-EB845	0,10 -0,20	0,10 -0,25	0,10 -0,30	0,20 -0,60	25 (15-30)	45 (30-70)	70 (40-120)	80 (45-135)	-	-	-
K6	NF/NS-EB845	0,10 -0,20	0,10 -0,25	0,10 -0,30	0,20 -0,60	-	60 (40-100)	80 (30-150)	90 (35-170)	-	-	-
K7	NF/NS-EB845	0,10 -0,20	0,10 -0,25	0,10 -0,30	0,20 -0,60	-	60 (40-100)	80 (30-150)	90 (35-170)	-	-	-
S1	NF/NS-EB845	0,08 -0,15	0,10 -0,15	0,10 -0,20	0,20- 0,30	-	15 (8-20)	20 (10-25)	-	-	-	20 (10-25)
S2	NF/NS-EB845	0,08 -0,15	0,10 -0,15	0,10 -0,20	0,20- 0,30	-	15 (8-20)	20 (10-25)	-	-	-	20 (10-25)
S3	NF/NS-EB845	0,08 -0,15	0,10 -0,15	0,10 -0,20	0,20- 0,30	-	15 (8-20)	20 (10-25)	-	-	-	25 (10-25)
S11	NF/NS-EB845	0,08 -0,15	0,10 -0,15	0,10 -0,20	0,20- 0,30	20 (15-30)	30 (15-40)	40 (20-50)	-	-	-	30 (20-50)
S12	NF/NS-EB845	0,08 -0,15	0,10 -0,15	0,10 -0,20	0,20- 0,30	20 (15-30)	30 (15-40)	40 (20-50)	-	-	-	30 (20-50)
S13	NF/NS-EB845	0,08 -0,15	0,10 -0,15	0,10 -0,20	0,20- 0,30	20 (15-30)	30 (15-40)	40 (20-50)	-	-	-	30 (20-50)
H3	NF/NS-EB845	0,08 -0,15	0,10 -0,15	0,10 -0,20	0,20- 0,30	-	-	10 (8-15)	-	-	-	-
H5	NF/NS-EB845	0,08 -0,15	0,10 -0,15	0,10 -0,20	0,20- 0,30	-	-	10 (8-15)	-	-	-	-
H7	NF/NS-EB845	0,08 -0,15	0,10 -0,15	0,10 -0,20	0,20- 0,30	-	-	10 (8-15)	-	-	-	-
H8	NF/NS-EB845	0,08 -0,15	0,10 -0,15	0,10 -0,20	0,20- 0,30	-	-	10 (8-15)	-	-	-	-
H11	NF/NS-EB845	0,08 -0,15	0,10 -0,15	0,10 -0,20	0,20- 0,30	-	-	10 (8-15)	-	-	-	-
H12	NF/NS-EB845	0,08 -0,15	0,10 -0,15	0,10 -0,20	0,20- 0,30	-	-	10 (8-15)	-	-	-	-
H21	NF/NS-EB845	0,08 -0,15	0,10 -0,15	0,10 -0,20	0,20- 0,30	-	-	10 (8-15)	-	-	-	-
H31	NF/NS-EB845	0,08 -0,15	0,10 -0,15	0,10 -0,20	0,20- 0,30	-	-	10 (8-15)	-	-	-	-
PM1	NF/NS-EB845	0,10 -0,15	0,1 -0,20	0,10 -0,20	0,20 -0,50	-	50 (30-80)	70 (40-100)	-	-	-	-
PM2	NF/NS-EB845	0,10 -0,15	0,1 -0,20	0,10 -0,20	0,20 -0,50	-	50 (30-80)	70 (40-100)	-	-	-	-
PM3	NF/NS-EB845	0,10 -0,15	0,1 -0,20	0,10 -0,20	0,20 -0,50	-	50 (30-80)	70 (40-100)	-	-	-	-

SMG = Grupy materiałowe Seco

a_p = mm

f = mm/obr

v_c = m/min

Wszystkie parametry są wartościami początkowymi

Parametry skrawania – NF/NS...-EB845 cale

SMG		a _p (°)		f		v _c						
		z=4	z=6	z=4	z=6	H15	CP20	RX2000	RK2050	RM2020	RM2090	RS2090
P3	NF/NS-EB845	0.004	0.004	0.004	0.008	-	195	260	-	-	-	-
		-0.006	-0.008	-0.012	-0.024		(100-330)	(100-490)				
P4	NF/NS-EB845	0.004	0.004	0.004	0.008	-	165	195	-	-	-	-
		-0.006	-0.008	-0.008	-0.020		(100-260)	(100-395)				
P5	NF/NS-EB845	0.004	0.004	0.004	0.008	65	165	195	-	-	-	-
		-0.006	-0.008	-0.008	-0.020	(35-80)	(100-260)	(100-395)				
P6	NF/NS-EB845	0.004	0.004	0.004	0.008	65	165	195	-	-	-	-
		-0.006	-0.008	-0.008	-0.020	(35-80)	(100-260)	(100-395)				
P7	NF/NS-EB845	0.004	0.004	0.004	0.008	65	165	195	-	-	-	-
		-0.006	-0.008	-0.008	-0.020	(35-80)	(100-260)	(100-395)				
P8	NF/NS-EB845	0.004	0.004	0.004	0.008	50	115	130	-	-	-	-
		-0.006	-0.008	-0.008	-0.020	(35-65)	(65-195)	(65-260)				
P11	NF/NS-EB845	0.004	0.004	0.004	0.008	50	115	130	-	-	-	-
		-0.006	-0.008	-0.008	-0.020	(35-65)	(65-195)	(65-260)				
P12	NF/NS-EB845	0.004	0.004	0.004	0.008	40	80	100	-	-	-	-
		-0.006	-0.008	-0.008	-0.020	(25-50)	(50-150)	(50-125)				
M1	NF/NS-EB845	0.003	0.004	0.004	0.008	40	80	115	-	80	130	-
		-0.006	-0.006	-0.008	-0.02	(30-50)	(50-150)	(65-200)		(50-130)	(65-195)	
M2	NF/NS-EB845	0.003	0.004	0.004	0.008	-	80	115	-	80	130	-
		-0.006	-0.006	-0.008	-0.02		(50-150)	(65-200)		(50-130)	(65-195)	
M3	NF/NS-EB845	0.003	0.004	0.004	0.008	-	80	115	-	80	130	-
		-0.006	-0.006	-0.008	-0.02		(50-150)	(65-200)		(50-130)	(65-195)	
M4	NF/NS-EB845	0.003	0.004	0.004	0.008	-	65	80	-	80	100	-
		-0.006	-0.006	-0.008	-0.02		(30-100)	(50-135)		(35-100)	(50-130)	
M5	NF/NS-EB845	0.003	0.004	0.004	0.008	-	65	80	-	80	100	-
		-0.006	-0.006	-0.008	-0.02		(30-100)	(50-135)		(35-100)	(50-130)	
K1	NF/NS-EB845	0.004	0.004	0.004	0.008	80	195	260	290	-	-	-
		-0.008	-0.010	-0.012	-0.024	(50-100)	(130-330)	(100-490)	(110-550)			
K2	NF/NS-EB845	0.004	0.004	0.004	0.008	-	80	130	145	-	-	-
		-0.008	-0.010	-0.012	-0.024		(65-130)	(100-230)	(110-260)			
K3	NF/NS-EB845	0.004	0.004	0.004	0.008	80	195	260	290	-	-	-
		-0.008	-0.010	-0.012	-0.024	(50-100)	(130-330)	(100-490)	(110-550)			
K4	NF/NS-EB845	0.004	0.004	0.004	0.008	80	150	230	260	-	-	-
		-0.008	-0.010	-0.012	-0.024	(50-100)	(100-330)	(130-395)	(145-440)			
K5	NF/NS-EB845	0.004	0.004	0.004	0.008	80	150	230	260	-	-	-
		-0.008	-0.010	-0.012	-0.024	(50-100)	(100-330)	(130-395)	(145-440)			
K6	NF/NS-EB845	0.004	0.004	0.004	0.008	-	195	260	290	-	-	-
		-0.008	-0.010	-0.012	-0.024		(130-330)	(100-490)	(110-550)			
K7	NF/NS-EB845	0.004	0.004	0.004	0.008	-	195	260	290	-	-	-
		-0.008	-0.010	-0.012	-0.024		(130-330)	(100-490)	(110-550)			
S1	NF/NS-EB845	0.003	0.004	0.004	0.008	-	50	65	-	-	-	65
		-0.006	-0.006	-0.008	-0.012		(25-65)	(35-80)				(35-80)
S2	NF/NS-EB845	0.003	0.004	0.004	0.008	-	50	65	-	-	-	65
		-0.006	-0.006	-0.008	-0.012		(25-65)	(35-80)				(35-80)
S3	NF/NS-EB845	0.003	0.004	0.004	0.008	-	50	65	-	-	-	65
		-0.006	-0.006	-0.008	-0.012		(25-65)	(35-80)				(35-80)
S11	NF/NS-EB845	0.003	0.004	0.004	0.008	65	100	130	-	-	-	100
		-0.006	-0.006	-0.008	-0.012	(50-100)	(50-130)	(65-165)				(65-165)
S12	NF/NS-EB845	0.003	0.004	0.004	0.008	65	100	130	-	-	-	100
		-0.006	-0.006	-0.008	-0.012	(50-100)	(50-130)	(65-165)				(65-165)
S13	NF/NS-EB845	0.003	0.004	0.004	0.008	65	100	130	-	-	-	100
		-0.006	-0.006	-0.008	-0.012	(50-100)	(50-130)	(65-165)				(65-165)
H3	NF/NS-EB845	0.003	0.004	0.004	0.008	-	-	35	-	-	-	-
		-0.006	-0.006	-0.008	-0.012			(25-50)				
H5	NF/NS-EB845	0.003	0.004	0.004	0.008	-	-	35	-	-	-	-
		-0.006	-0.006	-0.008	-0.012			(25-50)				
H7	NF/NS-EB845	0.003	0.004	0.004	0.008	-	-	35	-	-	-	-
		-0.006	-0.006	-0.008	-0.012			(25-50)				
H8	NF/NS-EB845	0.003	0.004	0.004	0.008	-	-	35	-	-	-	-
		-0.006	-0.006	-0.008	-0.012			(25-50)				
H11	NF/NS-EB845	0.003	0.004	0.004	0.008	-	-	35	-	-	-	-
		-0.006	-0.006	-0.008	-0.012			(25-50)				
H12	NF/NS-EB845	0.003	0.004	0.004	0.008	-	-	35	-	-	-	-
		-0.006	-0.006	-0.008	-0.012			(25-50)				
H21	NF/NS-EB845	0.003	0.004	0.004	0.008	-	-	35	-	-	-	-
		-0.006	-0.006	-0.008	-0.012			(25-50)				
H31	NF/NS-EB845	0.003	0.004	0.004	0.008	-	-	35	-	-	-	-
		-0.006	-0.006	-0.008	-0.012			(25-50)				
PM1	NF/NS-EB845	0.004	0.004	0.004	0.008	-	165	230	-	-	-	-
		-0.006	-0.008	-0.008	-0.020		(100-260)	(130-350)				
PM2	NF/NS-EB845	0.004	0.004	0.004	0.008	-	165	230	-	-	-	-
		-0.006	-0.008	-0.008	-0.020		(100-260)	(130-350)				
PM3	NF/NS-EB845	0.004	0.004	0.004	0.008	-	165	230	-	-	-	-
		-0.006	-0.008	-0.008	-0.020		(100-260)	(130-350)				

SMG = Grupy materiałowe Seco
a_p = calowe
f = cal/obr.
v_c = stp/min
Wszystkie parametry są wartościami początkowymi

Parametry skrawania – NF/NS...-EB25/EB30 Metryczne

SMG		a_p (∅)		f		v_c			
		z=4	z=6	z=4	z=6	H15	CP20	RX2000	RK2050
P1	NF/NS-EB25/EB30	0,10-0,15	0,1-0,20	0,3-0,9	0,5-1,2	25 (15-30)	60 (30-100)	80 (30-150)	-
P2	NF/NS-EB25/EB30	0,10-0,15	0,1-0,20	0,3-0,9	0,5-1,2	25 (15-30)	60 (30-100)	80 (30-150)	-
P3	NF/NS-EB25/EB30	0,10-0,15	0,1-0,20	0,3-0,9	0,5-1,2	25 (15-30)	60 (30-100)	80 (30-150)	-
P4	NF/NS-EB25/EB30	0,10-0,15	0,1-0,20	0,3-0,7	0,5-1	20 (10-25)	50 (30-80)	60 (30-120)	-
P5	NF/NS-EB25/EB30	0,10-0,15	0,1-0,20	0,3-0,7	0,5-1	20 (10-25)	50 (30-80)	60 (30-120)	-
P6	NF/NS-EB25/EB30	0,10-0,15	0,1-0,20	0,3-0,7	0,5-1	20 (10-25)	50 (30-80)	60 (30-120)	-
P7	NF/NS-EB25/EB30	0,10-0,15	0,1-0,20	0,3-0,7	0,5-1	20 (10-25)	50 (30-80)	60 (30-120)	-
M1	NF/NS-EB25/EB30	0,08-0,15	0,10-0,15	0,3-0,7	0,5-1	-	25 (15-40)	35 (20-60)	-
K1	NF/NS-EB25/EB30	0,10-0,20	0,10-0,25	0,3-0,9	0,5-1,2	25 (15-30)	60 (40-100)	80 (30-150)	90 (35-170)
K2	NF/NS-EB25/EB30	0,10-0,20	0,10-0,25	0,3-0,9	0,5-1,2	-	25 (20-40)	40 (30-70)	45 (35-80)
K3	NF/NS-EB25/EB30	0,10-0,20	0,10-0,25	0,3-0,9	0,5-1,2	25 (15-30)	60 (40-100)	80 (30-150)	90 (35-170)
K4	NF/NS-EB25/EB30	0,10-0,20	0,10-0,25	0,3-0,9	0,5-1,2	25 (15-30)	45 (30-70)	70 (40-120)	80 (45-135)
K5	NF/NS-EB25/EB30	0,10-0,20	0,10-0,25	0,3-0,9	0,5-1,2	25 (15-30)	45 (30-70)	70 (40-120)	80 (45-135)
K6	NF/NS-EB25/EB30	0,10-0,20	0,10-0,25	0,3-0,9	0,5-1,2	-	60 (40-100)	80 (30-150)	90 (35-170)
K7	NF/NS-EB25/EB30	0,10-0,20	0,10-0,25	0,3-0,9	0,5-1,2	-	60 (40-100)	80 (30-150)	90 (35-170)
N1	NF/NS-EB25/EB30	0,10-0,20	0,10-0,30	0,3-0,9	0,5-1,2	50 (20-80)	-	-	-
N2	NF/NS-EB25/EB30	0,10-0,20	0,10-0,30	0,3-0,9	0,5-1,2	50 (20-80)	-	-	-
N3	NF/NS-EB25/EB30	0,10-0,20	0,10-0,30	0,3-0,9	0,5-1,2	50 (20-80)	-	-	-
N11	NF/NS-EB25/EB30	0,10-0,20	0,10-0,30	0,3-0,9	0,5-1,2	50 (20-80)	-	-	-
PM1	NF/NS-EB25/EB30	0,10-0,15	0,1-0,20	0,3-0,9	0,5-1,2	-	50 (30-80)	70 (40-100)	-
PM2	NF/NS-EB25/EB30	0,10-0,15	0,1-0,20	0,3-0,9	0,5-1,2	-	50 (30-80)	70 (40-100)	-
PM3	NF/NS-EB25/EB30	0,10-0,15	0,1-0,20	0,3-0,9	0,5-1,2	-	50 (30-80)	70 (40-100)	-

SMG = Grupy materiałowe Seco

 a_p = mm

f = mm/obr

 v_c = m/min

Wszystkie parametry są wartościami początkowymi

Parametry skrawania – EB25/EB30 *całe*

SMG		a_p (°)		f		v_c			
		z=4	z=6	z=4	z=6	H15	CP20	RX2000	RK2050
P1	NF/NS-EB25/EB30	0.004–0.006	0.004–0.008	0.012–0.035	0.020–0.047	80 (50-100)	195 (100-330)	260 (100-490)	–
P2	NF/NS-EB25/EB30	0.004–0.006	0.004–0.008	0.012–0.035	0.020–0.047	80 (50-100)	195 (100-330)	260 (100-490)	–
P3	NF/NS-EB25/EB30	0.004–0.006	0.004–0.008	0.012–0.035	0.020–0.047	80 (50-100)	195 (100-330)	260 (100-490)	–
P4	NF/NS-EB25/EB30	0.004–0.006	0.004–0.008	0.012–0.028	0.020–0.039	65 (35-80)	165 (100-265)	195 (100-395)	–
P5	NF/NS-EB25/EB30	0.004–0.006	0.004–0.008	0.012–0.028	0.020–0.039	65 (35-80)	165 (100-265)	195 (100-395)	–
P6	NF/NS-EB25/EB30	0.004–0.006	0.004–0.008	0.012–0.028	0.020–0.039	65 (35-80)	165 (100-265)	195 (100-395)	–
P7	NF/NS-EB25/EB30	0.004–0.006	0.004–0.008	0.012–0.028	0.020–0.039	65 (35-80)	165 (100-265)	195 (100-395)	–
M1	NF/NS-EB25/EB30	0.003–0.006	0.004–0.006	0.012–0.028	0.020–0.039	–	80 (50-130)	115 (65-195)	–
K1	NF/NS-EB25/EB30	0.004–0.008	0.004–0.010	0.012–0.035	0.020–0.047	80 (50-100)	195 (130-330)	260 (100-490)	290 (110-550)
K2	NF/NS-EB25/EB30	0.004–0.008	0.004–0.010	0.012–0.035	0.020–0.047	–	80 (65-130)	130 (100-230)	145 (110-260)
K3	NF/NS-EB25/EB30	0.004–0.008	0.004–0.010	0.012–0.035	0.020–0.047	80 (50-100)	195 (130-330)	260 (100-490)	290 (110-550)
K4	NF/NS-EB25/EB30	0.004–0.008	0.004–0.010	0.012–0.035	0.020–0.047	80 (50-100)	150 (100-230)	230 (130-395)	260 (145-440)
K5	NF/NS-EB25/EB30	0.004–0.008	0.004–0.010	0.012–0.035	0.020–0.047	80 (50-100)	150 (100-230)	230 (130-395)	260 (145-440)
K6	NF/NS-EB25/EB30	0.004–0.008	0.004–0.010	0.012–0.035	0.020–0.047	–	195 (130-330)	260 (100-490)	290 (110-550)
K7	NF/NS-EB25/EB30	0.004–0.008	0.004–0.010	0.012–0.035	0.020–0.047	–	195 (130-330)	260 (100-490)	290 (110-550)
N1	NF/NS-EB25/EB30	0.004–0.787	0.004–0.012	0.012–0.035	0.020–0.047	165 (65-265)	–	–	–
N2	NF/NS-EB25/EB30	0.004–0.787	0.004–0.012	0.012–0.035	0.020–0.047	165 (65-265)	–	–	–
N3	NF/NS-EB25/EB30	0.004–0.787	0.004–0.012	0.012–0.035	0.020–0.047	165 (65-265)	–	–	–
N11	NF/NS-EB25/EB30	0.004–0.787	0.004–0.012	0.012–0.035	0.020–0.047	165 (65-265)	–	–	–
PM1	NF/NS-EB25/EB30	0.004–0.006	0.004–0.008	0.012–0.035	0.020–0.047	–	165 (100-265)	230 (130-330)	–
PM2	NF/NS-EB25/EB30	0.004–0.006	0.004–0.008	0.012–0.035	0.020–0.047	–	165 (100-265)	230 (130-330)	–
PM3	NF/NS-EB25/EB30	0.004–0.006	0.004–0.008	0.012–0.035	0.020–0.047	–	165 (100-265)	230 (130-330)	–

SMG = Grupy materiałowe Seco

a_p = *całowe*

f = *cał/obr.*

v_c = *stp/min*

Wszystkie parametry są wartościami początkowymi

Wstęp

Wiercenie

Rozwiercanie

Wytaczanie

Załącznik

Instrukcje odnośnie ostrzenia

Warunki techniczne

Ściernica diamentowa

wielkość ziarna:

D6 – Dla pierwszego kąta przyłożenia (β_1 - β_3)

D64 – Dla drugiego kąta przyłożenia (β_2)

Uwaga

Ostrzenie zmniejsza średnicę rozwiertaka.

Ponowne pokrywanie może zwiększać średnicę rozwiertaka.

Maks. bicie na fazach czołowych 10 μ m (394 μ cala).

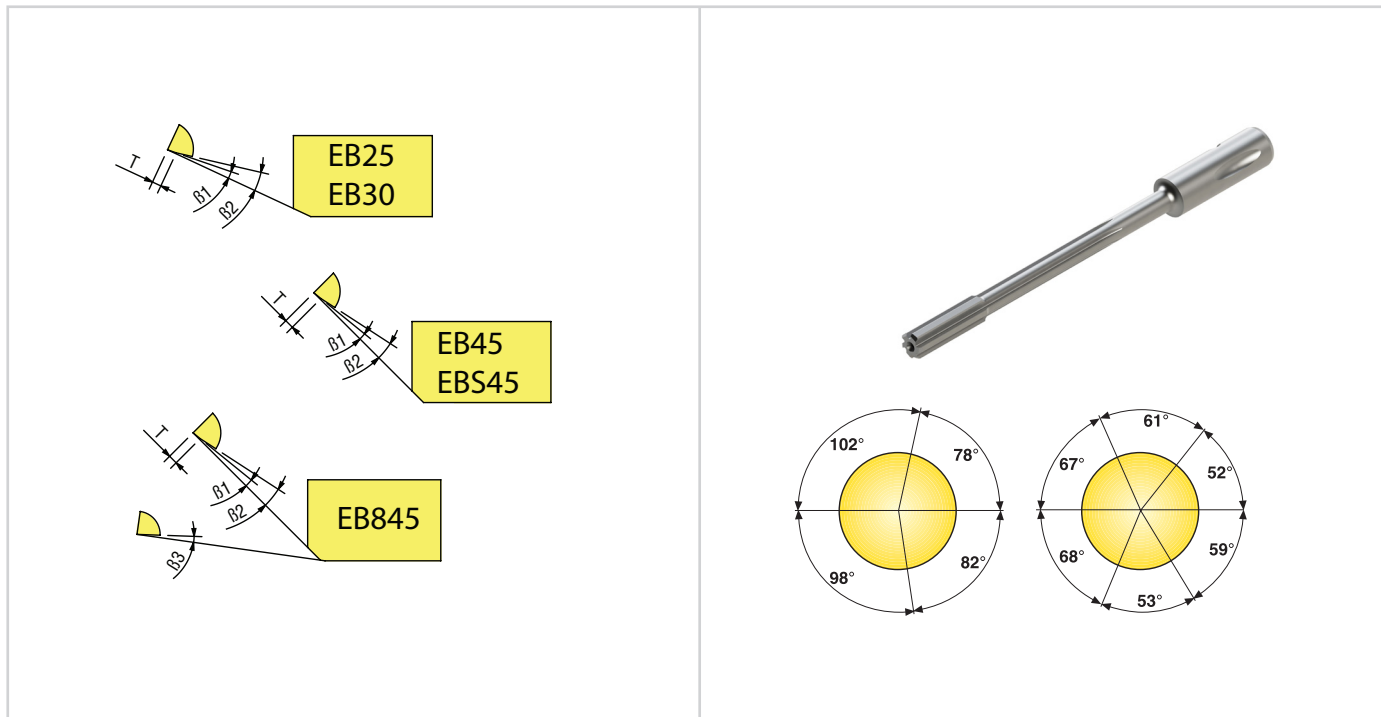

Nanofix \varnothing	β_1	β_2	β_3	T
2,97-9,99 mm	8°	18°	8°	0,15 mm
10,00-12,050 mm				0,20 mm



BIFIX®

Rozwiertaki Bifix® z wymiennymi płytkami zapewniają wysoką precyzję we wszystkich obrabianych materiałach

- Pozwala uzyskać tolerancje pomiędzy 8 i 16 μm i gładkość powierzchni Ra 0,25 (RMS 12 mikro/cal)
- Wymienne płytki mają dwie krawędzie skrawające na płytkę
- Trzy cermetowe prowadnice i dokładny system regulacji

Przegląd asortymentu

	Zakres \varnothing	Głębokość rozwiercania	Tolerancja \varnothing otworu	Średnice pośrednie	Wykończenie powierzchni
SR80 Dla otworów przelotowych 	6,875-60,500 mm (0.2707-2.3819")	5-7 x D	IT 6	Tak, dostępne w ramach projektu niestandardowego	R_a 0,2-0,8 μm (R_a 8-31 μin)
SR81 Do otworów nieprzelotowych 	7,875-60,500 mm (0.3100-2.3819")	5-7 x D	IT 6-7	Tak, dostępne w ramach projektu niestandardowego	R_a 0,2-0,8 μm (R_a 8-31 μin)
SR82 Otwory nieprzelotowe, wersja krótka 	7,875-60,500 mm (0.3100-2.3819")	3-5 x D	IT 6-7	Tak, dostępne w ramach projektu niestandardowego	R_a 0,2-0,8 μm (R_a 8-31 μin)

Oznaczenia

Rozwiertaki

Typ rozwiertaka:
Typ 80: Otwór przelotowy
Typ 81: Otwór nieprzelotowy
Typ 82: Otwory nieprzelotowe, wersja krótka



Typ rozwiertaka:
Typ 80: Otwór przelotowy
Typ 81: Otwór nieprzelotowy
Typ 82: Otwory nieprzelotowe, wersja krótka

Średnica i tolerancja otworu

Typy geometrii prowadzących
EN1, EN2, EN3

SR80 - **16,85 P6** - **EN1** - **R** - **9**

0.6624"-0.6628"

Rodzaj chwytu: (Będzie ustalone gdy wymagana wersja nie jest standardowa)
SR80 i SR81: R1 bez spłaszczenia jest standardem
SR82: R9 ze spłaszczeniem jest standardem

Płytki

Ważne:
Korpus rozwiertaka i płytka muszą mieć tę samą geometrię wejścia.

Wielkość płytki:
P0, P1, P2, P4

Kąt natarcia:
0°, 6°, 12°

P2 - **EN1** - **06** - **CP20**

Typy geometrii prowadzących
EN1, EN2, EN3

Gatunek węglik:
CP20, H15

Ustawianie i parametry skrawania

Narzędzie obrotowe

Maks. zalecane bicie: 0,02 mm (0.0008").
Zalecana jest oprawka precyzyjna: Oprawka hydrauliczna, na tulejki typu D, na tulejki 5672 lub Shrinkfit.

Narzędzie nieobrotowe

Zalecane jest stosowanie oprawek wahlowych Seco, patrz str. 481-485.

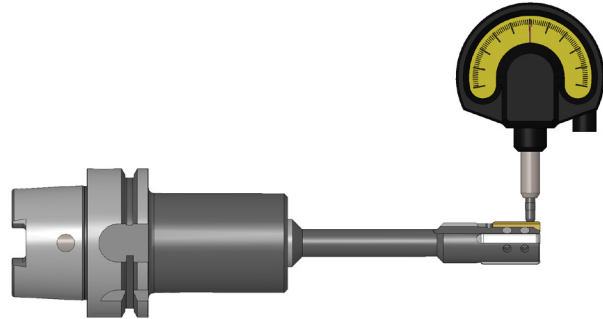

Nieprawidłowe usuwanie wiórów

Zalecane ustawienie płytki dla narzędzi nieobrotowych (patrz rysunek, widok z przodu narzędzi).

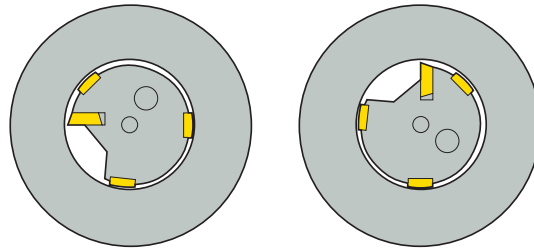

Wymagania odnośnie chłodzenia

Celem uzyskania maksymalnej trwałości ostrza oraz jakości otworu należy spełnić poniższe wymagania.
Zalecane jest chłodzenie przez narzędzie. Zewnętrzne chłodzenie można stosować gdy głębokość rozwiercania < 2 x D.
Dobrej jakości olej rozpuszczalny z dodatkiem min. 40% oleju mineralnego. Do stali nierdzewnej zaleca się olej bez domieszek.
Filtracja 30–50 µm (1200–2000 µcal).
Wydatek 0,5 l/min/mm (3.35 gal/min/cal) w średnicy narzędzia.
Np.: Rozwiertak Ø 10, min. wydatek to 5 l/min (1.3 gal/min).

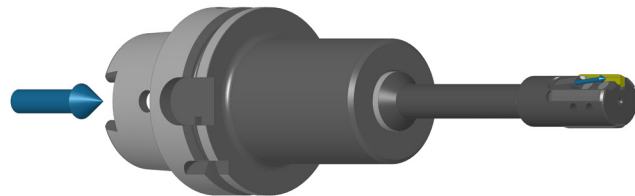

Przyrząd do ustawiania

SF-60200-C160C190: Nr produktu 02885396

- Stanowisko poziome
- Pierwszy wybór dla Ø mniejsze niż 60 mm (2.362")
- 2 czujniki
- Maksymalne Ø narzędzia: 60,5 mm (2.382")
- Maksymalna długość narzędzia: 200 mm (7.784")

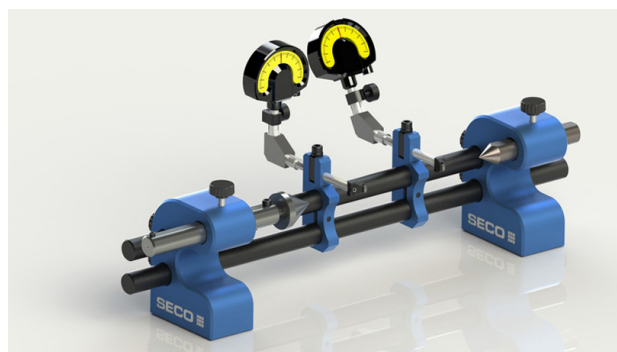

Wybór geometrii — płytki

Rozwiertak i płytka muszą mieć tę samą geometrię wejścia.

Gatunek i kąt natarcia

Zastosować tabele na str. 674–680, aby zaklasyfikować obrabiany materiał do grupy SMG.

Stosować tabelę zalecanych parametrów skrawania na str. 413-421 aby dobrać gatunek i kąt natarcia.

Program płytek przedstawiono na str. 411, 412.

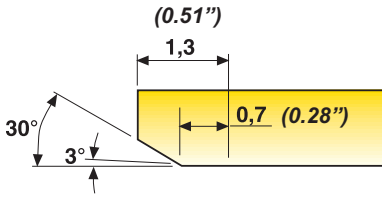
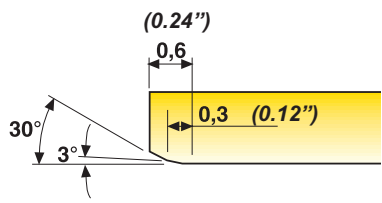
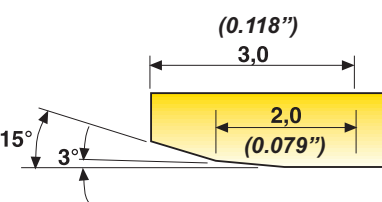
EN1 — Zastosowanie	
<p>Maksymalna dopuszczalna obróbka na powierzchni o średnicy 0,5 mm (0,020")</p> <p>Gładkość powierzchni + R_a 0,3–0,8 μm (Gładkość powierzchni + R_a 12–31 μcal)</p>	
EN2 - Krótka geometria wejścia	
<p>Maksymalny naddatek na obróbkę na \varnothing 0,3 mm (0.012")</p> <p>Gładkość powierzchni + R_a 0,4–1,2 μm (Gładkość powierzchni + R_a 16–47 μcal)</p> <p>Maksymalna prędkość posuwu 0,2 mm/obr (0.008" cal/obr).</p> <p>Stosować tylko tam, gdzie wymagana jest krótka geometria</p> <p>Zaprojektowany do otworów nieprzelotowych</p>	
EN3 - Najlepsza gładkość powierzchni	
<p>Maksymalny naddatek na obróbkę na \varnothing 0,5 mm (0.020")</p> <p>Gładkość powierzchni + R_a 0,2–0,6 μm (Gładkość powierzchni + R_a 8–24 μcal)</p> <p>Do wszystkich materiałów oprócz aluminium</p> <p>Stosować, gdy R_a powinno wynosić < 0,3–0,4 μm (12–16 μcal)</p>	

Wstęp

Wiercenie

Rozwiercanie

Wyfalcowanie

Załącznik

OPTYMALIZOWANIE GATUNKÓW

Dla uzyskania wyższej produktywności lub bezpieczeństwa płytkę należy dobrać na podstawie wskazówek z poniższej tabeli.

Wybór ostrza

Wielkość płytki	Stal	Stal nierdzewna	Żeliwo	Stopy nieżelazne	Aluminium	Odp. na ścieranie ↔ Ciągłość			Oznaczenie	
						Produktywność	Wszechstronność	Bezpieczeństwo	Płytki	Gatunek
						P0, P1, P2, P4			•	•
•		•	•	•				X	Pxx-ENx-06	H15
	•		•	•				X	Pxx-ENx-12	H15
•					X				Pxx-ENx-00	CP20
•		•					X		Pxx-ENx-06	CP20
•	•						X		Pxx-ENx-12	CP20
•		•			X				Pxx-ENx-00	CP15
•	•	•			X				Pxx-ENx-06	CP15
•	•		•	•	X				Pxx-ENx-12	CP15

Gatunki

	CP15	Pokrywany Jako alternatywa dla gatunku CP20 odporny na ścieranie. Do optymalizacji w żeliwie i stali. Nadaje się również do metali nieżelaznych. Ti(C, N)
	CP20	Pokrywany Uniwersalny gatunek odpowiedni dla większości materiałów, z wyjątkiem aluminium. TiN
	H15	Pokrywany Ciągliwy węgiel mikro-ziarnisty do wszystkich materiałów. Odpowiedni do operacji dokładnego rozwiercania dzięki bardzo dużej ostrości krawędzi.

Dla otworów przelotowych \varnothing 7H6-26H6

Typ chwytu R1, cylindryczny bez spłaszczenia, SR80

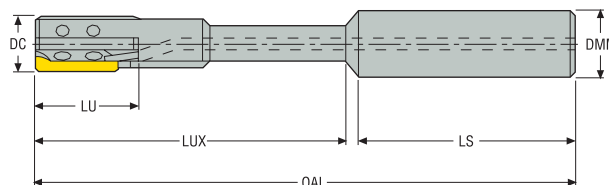

- Informacje dotyczące płytki na stronach 411, 412
- Wewnętrzny przepływ chłodziwa
- Parametry skrawania, patrz strona (strony) 413-421

Oznaczenie	DC	OAL	LS	LUX	LU	DMM	Wielkość płytki
	mm	mm	mm	mm	mm	mm	
SR80-7H6-EN1	7	105	40	63	25	10	P0-EN1-xx
SR80-8H6-EN1	8	115	40	73	25	10	P0-EN1-xx
SR80-9H6-EN1	9	115	40	73	25	10	P1-EN1-xx
SR80-10H6-EN1	10	115	40	74	25	10	P1-EN1-xx
SR80-11H6-EN1	11	133	48	81	25	16	P1-EN1-xx
SR80-12H6-EN1	12	133	48	81	25	16	P1-EN1-xx
SR80-13H6-EN1	13	133	48	81	25	16	P2-EN1-xx
SR80-14H6-EN1	14	133	48	81	25	16	P2-EN1-xx
SR80-15H6-EN1	15	133	48	82	25	16	P2-EN1-xx
SR80-16H6-EN1	16	133	48	82	25	16	P2-EN1-xx
SR80-17H6-EN1	17	155	50	100	25	20	P2-EN1-xx
SR80-18H6-EN1	18	155	50	100	25	20	P2-EN1-xx
SR80-19H6-EN1	19	155	50	100	25	20	P2-EN1-xx
SR80-20H6-EN1	20	155	50	100	30	20	P4-EN1-xx
SR80-21H6-EN1	21	191	56	128	30	25	P4-EN1-xx
SR80-22H6-EN1	22	191	56	129	30	25	P4-EN1-xx
SR80-23H6-EN1	23	191	56	129	30	25	P4-EN1-xx
SR80-24H6-EN1	24	191	56	129	30	25	P4-EN1-xx
SR80-25H6-EN1	25	191	56	129	30	25	P4-EN1-xx
SR80-26H6-EN1	26	191	56	129	30	25	P4-EN1-xx

Części zamienne

Dł. \varnothing (mm)	Śruba regulacyjna	Docisk	Śruba mocująca	Klucz ustawczy	Kulka podporowa	Klucz dynam.	Wielk. mom.
7-8	SH2020	SR-B0	LH2040	0.9SMS795	BB1.5	-	-
9	SH2025	SR-B1	LH2540	1.3SMS795	BB2.0	H00-1305	0,5 Nm
10-12	SH2525	SR-B2	LH2540	1.3SMS795	BB2.0	H00-1305	0,5 Nm
13-19	SH2540	SR-B3	LH3050	1.5SMS795	BB2.5	H00-1509	0,9 Nm
20-60	SH3060	SR-B5	LH4010	2SMS795	BB3.0	H00-2020	2,0 Nm

Klucz dynamometryczny jest dostarczany z wkładką

Dla otworów przelotowych \varnothing 27H6–60H6

Typ chwytu R1, cylindryczny bez spłaszczenia, SR80

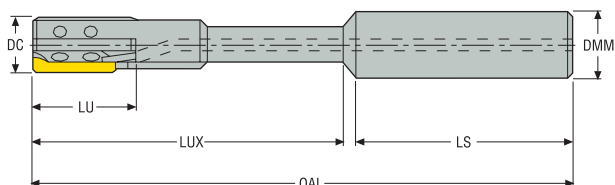

- Informacje dotyczące płytki na stronach 411, 412
- Wewnętrzny przepływ chłodziwa
- Parametry skrawania, patrz strona (strony) 413-421

Oznaczenie	DC	OAL	LS	LUX	LU	DMM	Wielkość płytki
	mm	mm	mm	mm	mm	mm	
SR80-27H6-EN1	27	221	56	159	30	25	P4-EN1-xx
SR80-28H6-EN1	28	221	56	159	30	25	P4-EN1-xx
SR80-29H6-EN1	29	221	56	159	30	25	P4-EN1-xx
SR80-30H6-EN1	30	221	56	159	30	25	P4-EN1-xx
SR80-31H6-EN1	31	221	56	160	30	25	P4-EN1-xx
SR80-32H6-EN1	32	221	56	160	30	25	P4-EN1-xx
SR80-34H6-EN1	34	226	56	165	30	25	P4-EN1-xx
SR80-35H6-EN1	35	226	56	165	30	25	P4-EN1-xx
SR80-36H6-EN1	36	226	56	166	30	25	P4-EN1-xx
SR80-38H6-EN1	38	226	56	166	30	25	P4-EN1-xx
SR80-40H6-EN1	40	226	56	166	30	25	P4-EN1-xx
SR80-42H6-EN1	42	226	56	167	30	25	P4-EN1-xx
SR80-44H6-EN1	44	226	56	167	30	25	P4-EN1-xx
SR80-48H6-EN1	48	226	56	168	30	25	P4-EN1-xx
SR80-50H6-EN1	50	226	56	168	30	25	P4-EN1-xx
SR80-52H6-EN1	52	226	56	169	30	25	P4-EN1-xx
SR80-54H6-EN1	54	226	56	169	30	25	P4-EN1-xx
SR80-58H6-EN1	58	226	56	169	30	25	P4-EN1-xx
SR80-60H6-EN1	60	226	56	169	30	25	P4-EN1-xx

Części zamienne

Dla \varnothing (mm)	Śruba regulacyjna	Docisk	Śruba mocująca	Klucz ustawczy	Kulka podporowa	Klucz dynam.	Wielk. mom.
20-60	SH4060	SR-B5	LH4010	2SMS795	BB3.0	H00-2020	2,0 Nm

Dla otworów przelotowych – Średnice pośrednie

Typ chwytu R1, cylindryczny bez spłaszczenia, SR80

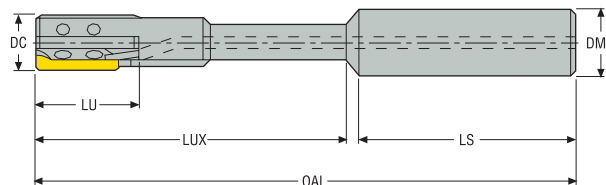

- Informacje dotyczące płytki na stronach 411, 412
- Uwaga! Korpus rozwiertaka i płytka muszą mieć tę samą geometrię wejścia
- Do wyboru geometrii prowadzącej EN1, EN2 lub EN3 Patrz str. 402
- Parametry skrawania, patrz strona (strony) 413-421

Oznaczenie	DC	OAL	LS	LUX	LU	DMM	Wielkość płytki
	mm	mm	mm	mm	mm	mm	
SR80-6.875-XX-XXXX-EN	6,875 - 7,874	105,0	40,0	63,0	15,0	10,0	P0-EN-xx
SR80-7.875-XX-XXXX-EN	7,875 - 8,749	115,0	40,0	73,0	25,0	10,0	P0-EN-xx
SR80-8.750-XX-XXXX-EN	8,75 - 9,749	115,0	40,0	73,0	25,0	10,0	P1-EN-xx
SR80-9.750-XX-XXXX-EN	9,75 - 10,749	115,0	40,0	73,0	25,0	10,0	P1-EN-xx
SR80-10.750-XX-XXXX-EN	10,75 - 12,749	133,0	48,0	81,0	25,0	16,0	P1-EN-xx
SR80-12.750-XX-XXXX-EN	12,75 - 16,749	133,0	48,0	81,0	25,0	16,0	P2-EN-xx
SR80-16.750-XX-XXXX-EN	16,75 - 19,499	155,0	50,0	100,0	25,0	20,0	P2-EN-xx
SR80-19.500-XX-XXXX-EN	19,5 - 20,499	155,0	50,0	100,0	30,0	20,0	P4-EN-xx
SR80-20.500-XX-XXXX-EN	20,5 - 26,499	191,0	56,0	129,0	30,0	25,0	P4-EN-xx
SR80-26.500-XX-XXXX-EN	26,5 - 32,499	221,0	56,0	160,0	30,0	25,0	P4-EN-xx
SR80-32.500-XX-XXXX-EN	32,5 - 38,499	226,0	56,0	165,0	30,0	25,0	P4-EN-xx
SR80-38.500-XX-XXXX-EN	38,5 - 40,499	226,0	56,0	166,0	30,0	25,0	P4-EN-xx
SR80-40.500-XX-XXXX-EN	40,5 - 44,499	226,0	56,0	167,0	30,0	25,0	P4-EN-xx
SR80-44.500-XX-XXXX-EN	44,5 - 50,499	226,0	56,0	168,0	30,0	25,0	P4-EN-xx
SR80-50.500-XX-XXXX-EN	50,5 - 60,5	226,0	56,0	169,0	30,0	25,0	P4-EN-xx

Części zamienne, zawarte w dostawie

Akcesoria

Dla \varnothing (mm)	Śruba regulacyjna	Mocowanie	Śruba mocująca	Klucz ustawczy	Kulka podtrzymująca	Klucz dynamometryczny
6,875-8,749	SH2020	SR-B0	LH2040	0.9SMS795	BB1.5	-
8,750-9,749	SH2525	SR-B1	LH2540	1.3SMS795	BB2.0	H00-1305
9,750-12,749	SH2525	SR-B2	LH2540	1.3SMS795	BB2.0	H00-1305
12,750-19,499	SH3040	SR-B3	LH3050	1.5SMS795	BB2.0	H00-1509
19,500-60,500	SH4060	SR-B5	LH4010	2SMS795	BB3.0	H00-2020

Klucz dynamometryczny jest dostarczany z wkładką

Uwaga! Przy zamawianiu rozwiertaczy dla średnicy pośredniej proszę podać: \varnothing i tolerancję otworu, geometrię prowadzącą (EN1, EN2 lub EN3).

Przykładowe zamówienie: SR80-11.50 H7-EN2, P1-EN2-06, CP20.

Do otworów nieprzelotowych \varnothing 8H6-26H6

Typ chwytu R1, cylindryczny bez spłaszczenia, SR81

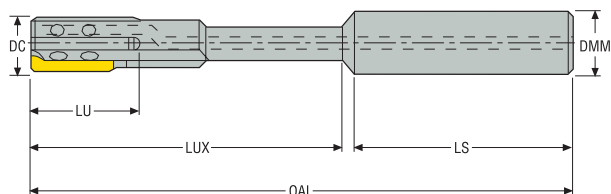

- Informacje dotyczące płytki na stronach 411, 412
- Wewnętrzny przepływ chłodziwa
- Parametry skrawania, patrz strona (strony) 413-421

Oznaczenie	DC	OAL	LS	LUX	LU	DMM	Wielkość płytki
	mm	mm	mm	mm	mm	mm	
SR81-8H6-EN1	8	115	40	73	25	10	P0-EN1-xx
SR81-9H6-EN1	9	115	40	73	25	10	P1-EN1-xx
SR81-11H6-EN1	11	133	48	81	25	16	P1-EN1-xx
SR81-13H6-EN1	13	133	48	81	25	16	P2-EN1-xx
SR81-14H6-EN1	14	133	48	81	25	16	P2-EN1-xx
SR81-15H6-EN1	15	133	48	82	25	16	P2-EN1-xx
SR81-16H6-EN1	16	133	48	82	25	16	P2-EN1-xx
SR81-17H6-EN1	17	155	50	100	25	20	P2-EN1-xx
SR81-18H6-EN1	18	155	50	100	25	20	P2-EN1-xx
SR81-19H6-EN1	19	155	50	100	25	20	P2-EN1-xx
SR81-20H6-EN1	20	155	50	100	30	20	P4-EN1-xx
SR81-21H6-EN1	21	191	56	128	30	25	P4-EN1-xx
SR81-22H6-EN1	22	191	56	129	30	25	P4-EN1-xx
SR81-23H6-EN1	23	191	56	129	30	25	P4-EN1-xx
SR81-25H6-EN1	25	191	56	129	30	25	P4-EN1-xx
SR81-26H6-EN1	26	191	56	129	30	25	P4-EN1-xx

Części zamienne

Dla \varnothing (mm)	Śruba regulacyjna	Docisk	Śruba mocująca	Klucz ustawczy	Kulka podporowa	Klucz dynam.	Wielk. mom.
8	SH2020	SR-B0	LH2040	0.9SMS795	BB1.5	-	-
9	SH2525	SR-B1	LH2540	1.3SMS795	BB2.0	H00-1305	0,5 Nm
10-12	SH2525	SR-B2	LH2540	1.3SMS795	BB2.0	H00-1305	0,5 Nm
13-19	SH3040	SR-B3	LH3050	1.5SMS795	BB2.5	H00-1509	0,9 Nm
20-60	SH4060	SR-B5	LH4010	2SMS795	BB3.0	H00-2020	2,0 Nm

Do otworów nieprzelotowych \varnothing 27H6–60H6

Typ chwytu R1, cylindryczny bez spłaszczenia, SR81

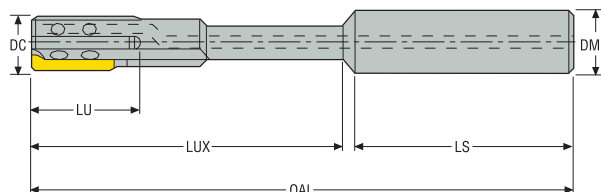

- Informacje dotyczące płytki na stronach 411, 412
- Wewnętrzny przepływ chłodziwa
- Parametry skrawania, patrz strona (strony) 413-421

Oznaczenie	DC	OAL	LS	LUX	LU	DMM	Wielkość płytki
	mm	mm	mm	mm	mm	mm	
SR81-27H6-EN1	27	221	56	159	30	25	P4-EN1-xx
SR81-28H6-EN1	28	221	56	159	30	25	P4-EN1-xx
SR81-29H6-EN1	29	221	56	159	30	25	P4-EN1-xx
SR81-30H6-EN1	30	221	56	159	30	25	P4-EN1-xx
SR81-31H6-EN1	31	221	56	160	30	25	P4-EN1-xx
SR81-32H6-EN1	32	221	56	160	30	25	P4-EN1-xx
SR81-34H6-EN1	34	226	56	165	30	25	P4-EN1-xx
SR81-35H6-EN1	35	226	56	165	30	25	P4-EN1-xx
SR81-36H6-EN1	36	226	56	166	30	25	P4-EN1-xx
SR81-38H6-EN1	38	226	56	166	30	25	P4-EN1-xx
SR81-40H6-EN1	40	226	56	166	30	25	P4-EN1-xx
SR81-42H6-EN1	42	226	56	167	30	25	P4-EN1-xx
SR81-44H6-EN1	44	226	56	167	30	25	P4-EN1-xx
SR81-48H6-EN1	48	226	56	168	30	25	P4-EN1-xx
SR81-50H6-EN1	50	226	56	168	30	25	P4-EN1-xx
SR81-52H6-EN1	52	226	56	169	30	25	P4-EN1-xx
SR81-54H6-EN1	54	226	56	169	30	25	P4-EN1-xx
SR81-58H6-EN1	58	226	56	169	30	25	P4-EN1-xx
SR81-60H6-EN1	60	226	56	169	30	25	P4-EN1-xx

Części zamienne

Dla \varnothing (mm)	Śruba regulacyjna	Docisk	Śruba mocująca	Klucz ustawczy	Kulka podporowa	Klucz dynam.	Wielk. mom.
20-60	SH4060	SR-B5	LH4010	2SMS795	BB3.0	H00-2020	2,0 Nm

Klucz dynamometryczny jest dostarczany z wkładką

Wstęp

Wiercenie

Rozwiercanie

Wytaczanie

Załącznik

Do otworów nieprzelotowych – Średnice pośrednie

Typ chwytu R1, cylindryczny bez spłaszczenia, SR81

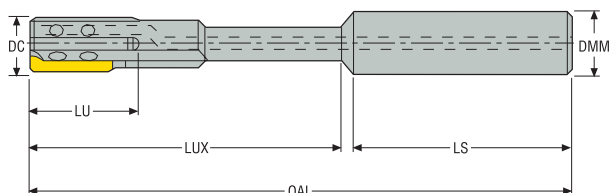

- Informacje dotyczące płytki na stronach 411, 412
- Uwaga! Korpus rozwiertaka i płytka muszą mieć tę samą geometrię wejścia
- Do wyboru geometrii prowadzącej EN1, EN2 lub EN3 Patrz str. 402
- Parametry skrawania, patrz strona (strony) 413-421

Oznaczenie	DC	OAL	LS	LUX	LU	DMM	Wielkość płytki
	mm	mm	mm	mm	mm	mm	
SR81-7.875-XX-XXXX-EN	7,875 - 8,749	115,0	40,0	73,0	25,0	10,0	P0-EN-xx
SR81-8.750-XX-XXXX-EN	8,75 - 9,749	115,0	40,0	73,0	25,0	10,0	P1-EN-xx
SR81-9.750-XX-XXXX-EN	9,75 - 10,749	115,0	40,0	73,0	25,0	10,0	P1-EN-xx
SR81-10.750-XX-XXXX-EN	10,75 - 12,749	133,0	48,0	81,0	25,0	16,0	P1-EN-xx
SR81-12.750-XX-XXXX-EN	12,75 - 16,749	133,0	48,0	81,0	25,0	16,0	P2-EN-xx
SR81-16.750-XX-XXXX-EN	16,75 - 19,499	155,0	50,0	100,0	25,0	20,0	P2-EN-xx
SR81-19.500-XX-XXXX-EN	19,5 - 20,499	155,0	50,0	100,0	30,0	20,0	P4-EN-xx
SR81-20.500-XX-XXXX-EN	20,5 - 26,499	191,0	56,0	129,0	30,0	25,0	P4-EN-xx
SR81-26.500-XX-XXXX-EN	26,5 - 32,499	221,0	56,0	160,0	30,0	25,0	P4-EN-xx
SR81-32.500-XX-XXXX-EN	32,5 - 38,499	226,0	56,0	165,0	30,0	25,0	P4-EN-xx
SR81-38.500-XX-XXXX-EN	38,5 - 40,499	226,0	56,0	166,0	30,0	25,0	P4-EN-xx
SR81-40.500-XX-XXXX-EN	40,5 - 44,499	226,0	56,0	167,0	30,0	25,0	P4-EN-xx
SR81-44.500-XX-XXXX-EN	44,5 - 50,499	226,0	56,0	168,0	30,0	25,0	P4-EN-xx
SR81-50.500-XX-XXXX-EN	50,5 - 60,5	226,0	56,0	169,0	30,0	25,0	P4-EN-xx

Części zamienne, zawarte w dostawie

Akcesoria

Dla \varnothing (mm)	Śruba regulacyjna	Mocowanie	Śruba mocująca	Klucz ustawczy	Kulka podtrzymująca	Klucz dynamometryczny
9,75-12,749	SH2525	SR-B2	LH2540	1.3SMS795	BB2.0	H00-1305
12,75-19,499	SH3040	SR-B3	LH3050	1.5SMS795	BB2.5	H00-1509
19,5-60,5	SH4060	SR-B5	LH4010	2SMS795	BB3.0	H00-2020
7,875-8,749	SH2020	SR-B0	LH2040	0.9SMS795	BB1.5	-
8,75-9,749	SH2525	SR-B1	LH2540	1.3SMS795	BB2.0	H00-1305

Klucz dynamometryczny jest dostarczany z wkładką

Uwaga! Przy zamawianiu rozwiertaczy dla średnicy pośredniej proszę podać: \varnothing i tolerancję otworu, geometrię prowadzącą (EN1, EN2 lub EN3).

Przykładowe zamówienie: SR81-11.50 H7-EN2, P1-EN2-06, CP20.

Do otworów nieprzelotowych – Krótki zakres do toczenia

Typ chwytu R9, cylindryczny ze spłaszczeniem, SR82

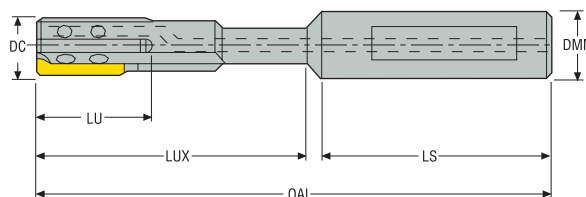

- Informacje dotyczące płytki na stronach 411, 412
- Uwaga! Korpus rozwiertaka i płytka muszą mieć tę samą geometrię wejścia
- Do wyboru geometrii prowadzącej EN1, EN2 lub EN3 Patrz str. 402
- Parametry skrawania, patrz strona (strony) 413-421

Oznaczenie	DC	OAL	LS	LUX	LU	DMM	Wielkość płytki
	mm	mm	mm	mm	mm	mm	
SR82-7.875-XX-XXXX-EN	7,875 - 8,749	95,0	40,0	53,0	25,0	10,0	P0-EN-xx
SR82-8.750-XX-XXXX-EN	8,75 - 9,749	95,0	40,0	53,0	25,0	10,0	P1-EN-xx
SR82-9.750-XX-XXXX-EN	9,75 - 10,749	95,0	40,0	53,0	25,0	10,0	P1-EN-xx
SR82-10.750-XX-XXXX-EN	10,75 - 12,749	113,0	40,0	61,0	25,0	16,0	P1-EN-xx
SR82-12.750-XX-XXXX-EN	12,75 - 16,749	113,0	48,0	61,0	25,0	16,0	P2-EN-xx
SR82-16.750-XX-XXXX-EN	16,75 - 19,499	113,0	48,0	60,0	25,0	20,0	P2-EN-xx
SR82-19.500-XX-XXXX-EN	19,5 - 20,499	115,0	50,0	60,0	30,0	20,0	P4-EN-xx
SR82-20.500-XX-XXXX-EN	20,5 - 32,499	115,0	50,0	89,0	30,0	25,0	P4-EN-xx
SR82-32.500-XX-XXXX-EN	32,5 - 36,499	151,0	56,0	105,0	30,0	25,0	P4-EN-xx
SR82-36.500-XX-XXXX-EN	36,5 - 40,499	166,0	56,0	106,0	30,0	25,0	P4-EN-xx
SR82-40.500-XX-XXXX-EN	40,5 - 44,499	166,0	56,0	107,0	30,0	25,0	P4-EN-xx
SR82-44.500-XX-XXXX-EN	44,5 - 50,499	166,0	56,0	108,0	30,0	25,0	P4-EN-xx
SR82-50.500-XX-XXXX-EN	50,5 - 60,5	166,0	56,0	109,0	30,0	25,0	P4-EN-xx

Części zamienne, zawarte w dostawie

Aksesoria

Dłg. Ø (mm)	Śruba regulacyjna	Mocowanie	Śruba mocująca	Klucz ustawczy	Kulka podtrzymująca	Klucz dynamometryczny
9,75-12,749	SH2525	SR-B2	LH2540	1.3SMS795	BB2.0	H00-1305
12,75-19,499	SH3040	SR-B3	LH3050	1.5SMS795	BB2.5	H00-1509
19,5-60,5	SH4060	SR-B5	LH4010	2SMS795	BB3.0	H00-2020
7,875-8,749	SH2020	SR-B0	LH2040	0.9SMS795	BB1.5	-
8,75-9,749	SH2525	SR-B1	LH2540	1.3SMS795	BB2.0	H00-1305

Klucz dynamometryczny jest dostarczany z wkładką

Uwaga! Przy zamawianiu rozwiertaczy dla średnicy pośredniej proszę podać: Ø i tolerancję otworu, geometrię prowadzącą (EN1, EN2 lub EN3).

Przykładowe zamówienie: SR82-11.50 H7EN2, P1-EN2-06, CP20.

P0-P4 Płytki

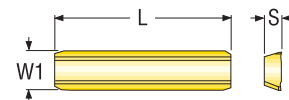

Oznaczenie	Płytki	L		S		W1		Gatunki	
		mm	Cal.	mm	Cal.	mm	Cal.	H15	CP20
P0-EN1-0	P0	20	0.787	1,2	0.047	2,5	0.098	00098229	00098244
P0-EN1-06	P0	20	0.787	1,2	0.047	2,5	0.098	00091786	00091762
P0-EN1-12	P0	20	0.787	1,2	0.047	2,5	0.098	00097299	00091971
P0-EN2-0	P0	20	0.787	1,2	0.047	2,5	0.098	00098234	00098249
P0-EN2-06	P0	20	0.787	1,2	0.047	2,5	0.098	00098160	00098170
P0-EN2-12	P0	20	0.787	1,2	0.047	2,5	0.098	00098165	00098175
P0-EN3-0	P0	20	0.787	1,2	0.047	2,5	0.098	00098239	00098254
P0-EN3-06	P0	20	0.787	1,2	0.047	2,5	0.098	00098185	00098195
P0-EN3-12	P0	20	0.787	1,2	0.047	2,5	0.098	00098190	00098200
P1-EN1-0	P1	20	0.787	1,5	0.059	3,0	0.118	00098230	00098245
P1-EN1-06	P1	20	0.787	1,5	0.059	3,0	0.118	00091787	00091764
P1-EN1-12	P1	20	0.787	1,5	0.059	3,0	0.118	00097300	00091972
P1-EN2-0	P1	20	0.787	1,5	0.059	3,0	0.118	00098235	00098250
P1-EN2-06	P1	20	0.787	1,5	0.059	3,0	0.118	00098161	00098171
P1-EN2-12	P1	20	0.787	1,5	0.059	3,0	0.118	00098166	00098176
P1-EN3-0	P1	20	0.787	1,5	0.059	3,0	0.118	00098240	00098255
P1-EN3-06	P1	20	0.787	1,5	0.059	3,0	0.118	00098186	00094702
P1-EN3-12	P1	20	0.787	1,5	0.059	3,0	0.118	00098191	00098201
P2-EN1-0	P2	20	0.787	2,0	0.079	4,5	0.177	00098231	00098246
P2-EN1-06	P2	20	0.787	2,0	0.079	4,5	0.177	00091788	00091765
P2-EN1-12	P2	20	0.787	2,0	0.079	4,5	0.177	00097301	00091973
P2-EN2-0	P2	20	0.787	2,0	0.079	4,5	0.177	00098236	00098251
P2-EN2-06	P2	20	0.787	2,0	0.079	4,5	0.177	00098162	00098172
P2-EN2-12	P2	20	0.787	2,0	0.079	4,5	0.177	00098167	00098177
P2-EN3-0	P2	20	0.787	2,0	0.079	4,5	0.177	00098241	00098256

Wstęp

Wiercenie

Rozwiercanie

Wytaczanie

Złączenie

Oznaczenie	Płytki	L	S	W1	Gatunki	
		mm Cal.	mm Cal.	mm Cal.	H15	CP20
P2-EN3-06	P2	20 0.787	2,0 0.079	4,5 0.177	00098187	00098197
P2-EN3-12	P2	20 0.787	2,0 0.079	4,5 0.177	00098192	00098202
P4-EN1-0	P4	25,0 0.984	2,3 0.091	7,0 0.276	00098232	00098247
P4-EN1-06	P4	25,0 0.984	2,3 0.091	7,0 0.276	00091789	00091766
P4-EN1-12	P4	25,0 0.984	2,3 0.091	7,0 0.276	00098128	00091974
P4-EN2-0	P4	25,0 0.984	2,3 0.091	7,0 0.276	00098237	00098252
P4-EN2-06	P4	25,0 0.984	2,3 0.091	7,0 0.276	00098163	00098173
P4-EN2-12	P4	25,0 0.984	2,3 0.091	7,0 0.276	00098168	00098178
P4-EN3-0	P4	25,0 0.984	2,3 0.091	7,0 0.276	00098242	00098257
P4-EN3-06	P4	25,0 0.984	2,3 0.091	7,0 0.276	00098188	00098198
P4-EN3-12	P4	25,0 0.984	2,3 0.091	7,0 0.276	00098193	00098203

Wstęp

Wiercenie

Rozwiercanie

Wytaczanie

Załącznik

Parametry skrawania – Pxx-EN1/EN2-00 Metryczne

SMG		$a_p (\varnothing)$		f	v_c	
		$\varnothing < 9$	$\varnothing \geq 9$		CP20	CP15
P5	Pxx-EN1/EN2-00	0,10-0,15	0,10-0,20	0,10-0,30	40 (30-50)	–
P6	Pxx-EN1/EN2-00	0,10-0,15	0,10-0,20	0,10-0,30	40 (30-50)	–
P7	Pxx-EN1/EN2-00	0,10-0,15	0,10-0,20	0,10-0,30	40 (30-50)	–
K1	Pxx-EN1/EN2-00	0,10-0,20	0,10-0,30	0,10-0,30	90 (80-100)	120 (80-150)
K2	Pxx-EN1/EN2-00	0,10-0,20	0,10-0,30	0,10-0,30	35 (25-50)	50 (25-70)
K3	Pxx-EN1/EN2-00	0,10-0,20	0,10-0,30	0,10-0,30	90 (80-100)	120 (80-150)
K4	Pxx-EN1/EN2-00	0,10-0,20	0,10-0,30	0,10-0,30	70 (60-80)	90 (80-100)
K5	Pxx-EN1/EN2-00	0,10-0,20	0,10-0,30	0,10-0,30	70 (60-80)	90 (80-100)
K6	Pxx-EN1/EN2-00	0,10-0,20	0,10-0,30	0,10-0,30	90 (80-100)	120 (80-150)
K7	Pxx-EN1/EN2-00	0,10-0,20	0,10-0,30	0,10-0,30	90 (80-100)	120 (80-150)
PM1	Pxx-EN1/EN2-00	0,10-0,20	0,10-0,30	0,10-0,30	50 (25-70)	–
PM2	Pxx-EN1/EN2-00	0,10-0,20	0,10-0,30	0,10-0,30	50 (25-70)	–
PM3	Pxx-EN1/EN2-00	0,10-0,20	0,10-0,30	0,10-0,30	50 (25-70)	–

SMG = Grupy materiałowe Seco

 a_p = mm

f = mm/obr

 v_c = m/min

Wszystkie parametry są wartościami początkowymi

Parametry skrawania – Pxx-EN1/EN2-00 cale

SMG		$a_p (\varnothing)$		f	v_c	
		$\varnothing < 9$	$\varnothing \geq 9$		CP20	CP15
P5	Pxx-EN1/EN2-00	0.004–0.006	0.004–0.008	0.004–0.012	130 (100-165)	–
P6	Pxx-EN1/EN2-00	0.004–0.006	0.004–0.008	0.004–0.012	130 (100-165)	–
P7	Pxx-EN1/EN2-00	0.004–0.006	0.004–0.008	0.004–0.012	130 (100-165)	–
K1	Pxx-EN1/EN2-00	0.004–0.008	0.004–0.012	0.004–0.012	295 (260-330)	395 (260-490)
K2	Pxx-EN1/EN2-00	0.004–0.008	0.004–0.012	0.004–0.012	115 (80-165)	165 (80-230)
K3	Pxx-EN1/EN2-00	0.004–0.008	0.004–0.012	0.004–0.012	295 (260-330)	395 (260-490)
K4	Pxx-EN1/EN2-00	0.004–0.008	0.004–0.012	0.004–0.012	230 (195-260)	295 (260-330)
K5	Pxx-EN1/EN2-00	0.004–0.008	0.004–0.012	0.004–0.012	230 (195-260)	295 (260-330)
K6	Pxx-EN1/EN2-00	0.004–0.008	0.004–0.012	0.004–0.012	295 (260-330)	395 (260-490)
K7	Pxx-EN1/EN2-00	0.004–0.008	0.004–0.012	0.004–0.012	295 (260-330)	395 (260-490)
PM1	Pxx-EN1/EN2-00	0.004–0.008	0.004–0.012	0.004–0.012	165 (80-230)	–
PM2	Pxx-EN1/EN2-00	0.004–0.008	0.004–0.012	0.004–0.012	165 (80-230)	–
PM3	Pxx-EN1/EN2-00	0.004–0.008	0.004–0.012	0.004–0.012	165 (80-230)	–

SMG = Grupy materiałowe Seco

 a_p = calowe

f = cal/obr.

 v_c = stp/min

Wszystkie parametry są wartościami początkowymi

Parametry skrawania – Pxx-EN1/EN2-06 Metryczne

SMG		$a_p (\varnothing)$		f	v_c		
		$\varnothing < 9$	$\varnothing \geq 9$		H15	CP20	CP15
P1	Pxx-EN1/EN2-06	0,10-0,15	0,10-0,20	0,10-0,30	40 (30-60)	105 (90-120)	120 (90-150)
P2	Pxx-EN1/EN2-06	0,10-0,15	0,10-0,20	0,10-0,30	40 (30-60)	105 (90-120)	120 (90-150)
P3	Pxx-EN1/EN2-06	0,10-0,15	0,10-0,20	0,10-0,30	40 (30-60)	105 (90-120)	120 (90-150)
P4	Pxx-EN1/EN2-06	0,10-0,15	0,10-0,20	0,10-0,30	35 (25-40)	60 (40-70)	80 (60-100)
P5	Pxx-EN1/EN2-06	0,10-0,15	0,10-0,20	0,10-0,30	35 (25-40)	60 (40-70)	80 (60-100)
P6	Pxx-EN1/EN2-06	0,10-0,15	0,10-0,20	0,10-0,30	35 (25-40)	60 (40-70)	80 (60-100)
P7	Pxx-EN1/EN2-06	0,10-0,15	0,10-0,20	0,10-0,30	35 (25-40)	60 (40-70)	80 (60-100)
P8	Pxx-EN1/EN2-06	0,10-0,15	0,10-0,20	0,10-0,30	30 (25-40)	50 (30-60)	60 (40-70)
P11	Pxx-EN1/EN2-06	0,10-0,15	0,10-0,20	0,10-0,30	30 (25-40)	50 (30-60)	60 (40-70)
P12	Pxx-EN1/EN2-06	0,10-0,15	0,10-0,20	0,10-0,30	25 (20-30)	40 (25-45)	45 (30-55)
M1	Pxx-EN1/EN2-06	0,10-0,15	0,10-0,20	0,10-0,30	25 (20-30)	35 (25-40)	35 (25-40)
M2	Pxx-EN1/EN2-06	0,10-0,15	0,10-0,20	0,10-0,30	25 (20-30)	35 (25-40)	35 (25-40)
M3	Pxx-EN1/EN2-06	0,10-0,15	0,10-0,20	0,10-0,30	25 (20-30)	35 (25-40)	35 (25-40)
M4	Pxx-EN1/EN2-06	0,10-0,15	0,10-0,20	0,10-0,30	20 (15-30)	30 (25-40)	30 (25-40)
M5	Pxx-EN1/EN2-06	0,10-0,15	0,10-0,20	0,10-0,30	20 (15-30)	30 (25-40)	30 (25-40)
K1	Pxx-EN1/EN2-06	0,10-0,20	0,10-0,30	0,10-0,30	-	90 (80-100)	120 (80-150)
K2	Pxx-EN1/EN2-06	0,10-0,20	0,10-0,30	0,10-0,30	-	35 (25-50)	50 (25-70)
K3	Pxx-EN1/EN2-06	0,10-0,20	0,10-0,30	0,10-0,30	-	90 (80-100)	120 (80-150)
K4	Pxx-EN1/EN2-06	0,10-0,20	0,10-0,30	0,10-0,30	-	70 (60-80)	90 (80-100)
K5	Pxx-EN1/EN2-06	0,10-0,20	0,10-0,30	0,10-0,30	-	70 (60-80)	90 (80-100)
K6	Pxx-EN1/EN2-06	0,10-0,20	0,10-0,30	0,10-0,30	-	90 (80-100)	120 (80-150)
K7	Pxx-EN1/EN2-06	0,10-0,20	0,10-0,30	0,10-0,30	-	90 (80-100)	120 (80-150)
N11	Pxx-EN1/EN2-06	0,10-0,30	0,20-0,50	0,10-0,30	65 (50-150)	90 (70-150)	-
S1	Pxx-EN1/EN2-06	0,10-0,15	0,10-0,20	0,10-0,30	-	25 (15-30)	-
S2	Pxx-EN1/EN2-06	0,10-0,15	0,10-0,20	0,10-0,30	-	25 (15-30)	-
S3	Pxx-EN1/EN2-06	0,10-0,15	0,10-0,20	0,10-0,30	-	25 (15-30)	-
PM1	Pxx-EN1/EN2-06	0,10-0,20	0,10-0,30	0,10-0,30	-	50 (25-70)	-
PM2	Pxx-EN1/EN2-06	0,10-0,20	0,10-0,30	0,10-0,30	-	50 (25-70)	-
PM3	Pxx-EN1/EN2-06	0,10-0,20	0,10-0,30	0,10-0,30	-	50 (25-70)	-

SMG = Grupy materiałowe Seco

a_p = mm

f = mm/obr

v_c = m/min

Wszystkie parametry są wartościami początkowymi

Wstęp

Wiercenie

Rozwiercanie

Wytaczanie

Załącznik

Parametry skrawania – Pxx-EN1/EN2-06 cale

SMG		a_p (°)		f	v_c		
		$\varnothing < 9$	$\varnothing \geq 9$		H15	CP20	CP15
P1	Pxx-EN1/EN2-06	0.004–0.006	0.004–0.008	0.004–0.012	130 (100-195)	345 (295-395)	395 (295-490)
P2	Pxx-EN1/EN2-06	0.004–0.006	0.004–0.008	0.004–0.012	130 (100-195)	345 (295-395)	395 (295-490)
P3	Pxx-EN1/EN2-06	0.004–0.006	0.004–0.008	0.004–0.012	130 (100-195)	345 (295-395)	395 (295-490)
P4	Pxx-EN1/EN2-06	0.004–0.006	0.004–0.008	0.004–0.012	115 (80-130)	195 (130-230)	260 (195-330)
P5	Pxx-EN1/EN2-06	0.004–0.006	0.004–0.008	0.004–0.012	115 (80-130)	195 (130-230)	260 (195-330)
P6	Pxx-EN1/EN2-06	0.004–0.006	0.004–0.008	0.004–0.012	115 (80-130)	195 (130-230)	260 (195-330)
P7	Pxx-EN1/EN2-06	0.004–0.006	0.004–0.008	0.004–0.012	115 (80-130)	195 (130-230)	260 (195-330)
P8	Pxx-EN1/EN2-06	0.004–0.006	0.004–0.008	0.004–0.012	100 (80-130)	165 (100-195)	195 (130-230)
P11	Pxx-EN1/EN2-06	0.004–0.006	0.004–0.008	0.004–0.012	100 (80-130)	165 (100-195)	195 (130-230)
P12	Pxx-EN1/EN2-06	0.004–0.006	0.004–0.008	0.004–0.012	80 (65-100)	130 (80-150)	150 (100-180)
M1	Pxx-EN1/EN2-06	0.004–0.006	0.004–0.008	0.004–0.012	80 (65-100)	115 (80-130)	115 (80-130)
M2	Pxx-EN1/EN2-06	0.004–0.006	0.004–0.008	0.004–0.012	80 (65-100)	115 (80-130)	115 (80-130)
M3	Pxx-EN1/EN2-06	0.004–0.006	0.004–0.008	0.004–0.012	80 (65-100)	115 (80-130)	115 (80-130)
M4	Pxx-EN1/EN2-06	0.004–0.006	0.004–0.008	0.004–0.012	65 (50-100)	100 (80-130)	100 (80-130)
M5	Pxx-EN1/EN2-06	0.004–0.006	0.004–0.008	0.004–0.012	65 (50-100)	100 (80-130)	100 (80-130)
K1	Pxx-EN1/EN2-06	0.004–0.008	0.004–0.012	0.004–0.012	–	295 (260-330)	395 (260-490)
K2	Pxx-EN1/EN2-06	0.004–0.008	0.004–0.012	0.004–0.012	–	115 (80-165)	165 (80-230)
K3	Pxx-EN1/EN2-06	0.004–0.008	0.004–0.012	0.004–0.012	–	295 (260-330)	395 (260-490)
K4	Pxx-EN1/EN2-06	0.004–0.008	0.004–0.012	0.004–0.012	–	230 (195-260)	295 (260-330)
K5	Pxx-EN1/EN2-06	0.004–0.008	0.004–0.012	0.004–0.012	–	230 (195-260)	295 (260-330)
K6	Pxx-EN1/EN2-06	0.004–0.012	0.008–0.020	0.004–0.012	215 (165-150)	295 (230-490)	–
K7	Pxx-EN1/EN2-06	0.004–0.012	0.008–0.020	0.004–0.012	215 (165-150)	295 (230-490)	–
N11	Pxx-EN1/EN2-06	0.004–0.012	0.008–0.020	0.004–0.012	215 (165-150)	295 (230-490)	–
S1	Pxx-EN1/EN2-06	0.004–0.006	0.004–0.008	0.004–0.012	–	80 (50-100)	–
S2	Pxx-EN1/EN2-06	0.004–0.006	0.004–0.008	0.004–0.012	–	80 (50-100)	–
S3	Pxx-EN1/EN2-06	0.004–0.006	0.004–0.008	0.004–0.012	–	80 (50-100)	–
PM1	Pxx-EN1/EN2-06	0.004–0.008	0.004–0.012	0.004–0.012	–	165 (80-230)	–
PM2	Pxx-EN1/EN2-06	0.004–0.008	0.004–0.012	0.004–0.012	–	165 (80-230)	–
PM3	Pxx-EN1/EN2-06	0.004–0.008	0.004–0.012	0.004–0.012	–	165 (80-230)	–

SMG = Grupy materiałowe Seco

 a_p = calowe

f = cal/obr.

 v_c = stp/min

Wszystkie parametry są wartościami początkowymi

Parametry skrawania – Pxx-EN1/EN2-12 Metryczne

SMG		$a_p (\varnothing)$		f	v_c		
		$\varnothing < 9$	$\varnothing \geq 9$		H15	CP20	CP15
P1	Pxx-EN1/EN2-12	0,10-0,15	0,10-0,20	0,10-0,30	40 (30-60)	105 (90-120)	120 (90-150)
P2	Pxx-EN1/EN2-12	0,10-0,15	0,10-0,20	0,10-0,30	40 (30-60)	105 (90-120)	120 (90-150)
P3	Pxx-EN1/EN2-12	0,10-0,15	0,10-0,20	0,10-0,30	40 (30-60)	105 (90-120)	120 (90-150)
P4	Pxx-EN1/EN2-12	0,10-0,15	0,10-0,20	0,10-0,30	35 (25-40)	60 (40-70)	80 (60-100)
P5	Pxx-EN1/EN2-12	0,10-0,15	0,10-0,20	0,10-0,30	35 (25-40)	60 (40-70)	80 (60-100)
P6	Pxx-EN1/EN2-12	0,10-0,15	0,10-0,20	0,10-0,30	35 (25-40)	60 (40-70)	80 (60-100)
P7	Pxx-EN1/EN2-12	0,10-0,15	0,10-0,20	0,10-0,30	35 (25-40)	60 (40-70)	80 (60-100)
P8	Pxx-EN1/EN2-12	0,10-0,15	0,10-0,20	0,10-0,30	30 (25-40)	50 (30-60)	60 (40-70)
P11	Pxx-EN1/EN2-12	0,10-0,15	0,10-0,20	0,10-0,30	30 (25-40)	50 (30-60)	60 (40-70)
P12	Pxx-EN1/EN2-12	0,10-0,15	0,10-0,20	0,10-0,30	25 (20-30)	40 (25-45)	45 (30-55)
M1	Pxx-EN1/EN2-12	0,10-0,15	0,10-0,20	0,10-0,30	25 (20-30)	35 (25-40)	35 (25-40)
M2	Pxx-EN1/EN2-12	0,10-0,15	0,10-0,20	0,10-0,30	25 (20-30)	35 (25-40)	35 (25-40)
M3	Pxx-EN1/EN2-12	0,10-0,15	0,10-0,20	0,10-0,30	25 (20-30)	35 (25-40)	35 (25-40)
M4	Pxx-EN1/EN2-12	0,10-0,15	0,10-0,20	0,10-0,30	20 (15-30)	30 (25-40)	30 (25-40)
M5	Pxx-EN1/EN2-12	0,10-0,15	0,10-0,20	0,10-0,30	20 (15-30)	30 (25-40)	30 (25-40)
K1	Pxx-EN1/EN2-12	0,10-0,20	0,10-0,30	0,10-0,30	–	90 (80-100)	–
K3	Pxx-EN1/EN2-12	0,10-0,20	0,10-0,30	0,10-0,30	–	90 (80-100)	–
K4	Pxx-EN1/EN2-12	0,10-0,20	0,10-0,30	0,10-0,30	–	70 (60-80)	–
K5	Pxx-EN1/EN2-12	0,10-0,20	0,10-0,30	0,10-0,30	–	70 (60-80)	–
N11	Pxx-EN1/EN2-12	0,10-0,30	0,20-0,50	0,10-0,30	65 (50-150)	90 (70-150)	–
S1	Pxx-EN1/EN2-12	0,10-0,15	0,10-0,20	0,10-0,30	–	25 (15-30)	–
S2	Pxx-EN1/EN2-12	0,10-0,15	0,10-0,20	0,10-0,30	–	25 (15-30)	–
S3	Pxx-EN1/EN2-12	0,10-0,15	0,10-0,20	0,10-0,30	–	25 (15-30)	–
PM1	Pxx-EN1/EN2-12	0,10-0,20	0,10-0,30	0,10-0,30	–	50 (25-70)	–
PM2	Pxx-EN1/EN2-12	0,10-0,20	0,10-0,30	0,10-0,30	–	50 (25-70)	–
PM3	Pxx-EN1/EN2-12	0,10-0,20	0,10-0,30	0,10-0,30	–	50 (25-70)	–

SMG = Grupy materiałowe Seco

a_p = mm

f = mm/obr

v_c = m/min

Wszystkie parametry są wartościami początkowymi

Wstęp

Wiercenie

Rozwiercanie

Wytaczanie

Załącznik

Parametry skrawania – Pxx-EN1/EN2-12 cale

SMG		a_p (°)		f	v_c		
		$\varnothing < 9$	$\varnothing \geq 9$		H15	CP20	CP15
P1	Pxx-EN1/EN2-12	0.004–0.006	0.004–0.008	0.004–0.012	130 (100-195)	345 (295-395)	395 (295-490)
P2	Pxx-EN1/EN2-12	0.004–0.006	0.004–0.008	0.004–0.012	130 (100-195)	345 (295-395)	395 (295-490)
P3	Pxx-EN1/EN2-12	0.004–0.006	0.004–0.008	0.004–0.012	130 (100-195)	345 (295-395)	395 (295-490)
P4	Pxx-EN1/EN2-12	0.004–0.006	0.004–0.008	0.004–0.012	115 (80-130)	195 (130-230)	260 (195-330)
P5	Pxx-EN1/EN2-12	0.004–0.006	0.004–0.008	0.004–0.012	115 (80-130)	195 (130-230)	260 (195-330)
P6	Pxx-EN1/EN2-12	0.004–0.006	0.004–0.008	0.004–0.012	115 (80-130)	195 (130-230)	260 (195-330)
P7	Pxx-EN1/EN2-12	0.004–0.006	0.004–0.008	0.004–0.012	115 (80-130)	195 (130-230)	260 (195-330)
P8	Pxx-EN1/EN2-12	0.004–0.006	0.004–0.008	0.004–0.012	100 (80-130)	165 (100-195)	195 (130-230)
P11	Pxx-EN1/EN2-12	0.004–0.006	0.004–0.008	0.004–0.012	100 (80-130)	165 (100-195)	195 (130-230)
P12	Pxx-EN1/EN2-12	0.004–0.006	0.004–0.008	0.004–0.012	80 (65-100)	130 (80-150)	150 (100-180)
M1	Pxx-EN1/EN2-12	0.004–0.006	0.004–0.008	0.004–0.012	80 (65-100)	115 (80-130)	115 (80-130)
M2	Pxx-EN1/EN2-12	0.004–0.006	0.004–0.008	0.004–0.012	80 (65-100)	115 (80-130)	115 (80-130)
M3	Pxx-EN1/EN2-12	0.004–0.006	0.004–0.008	0.004–0.012	80 (65-100)	115 (80-130)	115 (80-130)
M4	Pxx-EN1/EN2-12	0.004–0.006	0.004–0.008	0.004–0.012	65 (50-100)	100 (80-130)	100 (80-130)
M5	Pxx-EN1/EN2-12	0.004–0.006	0.004–0.008	0.004–0.012	65 (50-100)	100 (80-130)	100 (80-130)
K1	Pxx-EN1/EN2-12	0.004–0.008	0.004–0.012	0.004–0.012	–	295 (260-330)	–
K3	Pxx-EN1/EN2-12	0.004–0.008	0.004–0.012	0.004–0.012	–	295 (260-330)	–
K4	Pxx-EN1/EN2-12	0.004–0.008	0.004–0.012	0.004–0.012	–	230 (195-260)	–
K5	Pxx-EN1/EN2-12	0.004–0.008	0.004–0.012	0.004–0.012	–	230 (195-260)	–
N11	Pxx-EN1/EN2-12	0.004–0.012	0.008–0.020	0.004–0.012	215 (165-490)	295 (230-490)	–
S1	Pxx-EN1/EN2-12	0.004–0.006	0.004–0.008	0.004–0.012	–	80 (50-100)	–
S2	Pxx-EN1/EN2-12	0.004–0.006	0.004–0.008	0.004–0.012	–	80 (50-100)	–
S3	Pxx-EN1/EN2-12	0.004–0.006	0.004–0.008	0.004–0.012	–	80 (50-100)	–
PM1	Pxx-EN1/EN2-12	0.004–0.008	0.004–0.012	0.004–0.012	–	165 (80-230)	–
PM2	Pxx-EN1/EN2-12	0.004–0.008	0.004–0.012	0.004–0.012	–	165 (80-230)	–
PM3	Pxx-EN1/EN2-12	0.004–0.008	0.004–0.012	0.004–0.012	–	165 (80-230)	–

SMG = Grupy materiałowe Seco

 a_p = calowe

f = cal/obr.

 v_c = stp/min

Wszystkie parametry są wartościami początkowymi

Wstęp

Wiercenie

Rozwiercanie

Wytaczanie

Załącznik

Parametry skrawania – Pxx-EN3-00 Metryczne

SMG		a_p (°)		f	v_c	
		$\varnothing < 9$	$\varnothing \geq 9$		CP20	CP15
P5	Pxx-EN3-00	0,10-0,15	0,10-0,20	0,10-0,30	40 (30-50)	-
P6	Pxx-EN3-00	0,10-0,15	0,10-0,20	0,10-0,30	40 (30-50)	-
P7	Pxx-EN3-00	0,10-0,15	0,10-0,20	0,10-0,30	40 (30-50)	-
K1	Pxx-EN3-00	0,10-0,20	0,10-0,30	0,10-0,30	90 (80-100)	120 (80-150)
K2	Pxx-EN3-00	0,10-0,20	0,10-0,30	0,10-0,30	35 (25-50)	50 (25-70)
K3	Pxx-EN3-00	0,10-0,20	0,10-0,30	0,10-0,30	90 (80-100)	120 (80-150)
K4	Pxx-EN3-00	0,10-0,20	0,10-0,30	0,10-0,30	70 (60-80)	90 (80-100)
K5	Pxx-EN3-00	0,10-0,20	0,10-0,30	0,10-0,30	70 (60-80)	90 (80-100)
K6	Pxx-EN3-00	0,10-0,20	0,10-0,30	0,10-0,30	90 (80-100)	120 (80-150)
K7	Pxx-EN3-00	0,10-0,20	0,10-0,30	0,10-0,30	90 (80-100)	120 (80-150)
PM1	Pxx-EN3-00	0,10-0,20	0,10-0,30	0,10-0,30	50 (25-70)	-
PM2	Pxx-EN3-00	0,10-0,20	0,10-0,30	0,10-0,30	50 (25-70)	-
PM3	Pxx-EN3-00	0,10-0,20	0,10-0,30	0,10-0,30	50 (25-70)	-

SMG = Grupy materiałowe Seco

a_p = mm

f = mm/obr

v_c = m/min

Wszystkie parametry są wartościami początkowymi

Parametry skrawania – Pxx-EN3-00 cale

SMG		a_p (°)		f	v_c	
		$\varnothing < 9$	$\varnothing \geq 9$		CP20	CP15
P5	Pxx-EN3-00	0.004–0.006	0.004–0.008	0.004–0.012	130 (100-165)	-
P6	Pxx-EN3-00	0.004–0.006	0.004–0.008	0.004–0.012	130 (100-165)	-
P7	Pxx-EN3-00	0.004–0.006	0.004–0.008	0.004–0.012	130 (100-165)	-
K1	Pxx-EN3-00	0.004–0.008	0.004–0.012	0.004–0.012	295 (260-330)	395 (260-490)
K2	Pxx-EN3-00	0.004–0.008	0.004–0.012	0.004–0.012	115 (80-165)	165 (80-230)
K3	Pxx-EN3-00	0.004–0.008	0.004–0.012	0.004–0.012	295 (260-330)	395 (260-490)
K4	Pxx-EN3-00	0.004–0.008	0.004–0.012	0.004–0.012	230 (195-260)	295 (260-330)
K5	Pxx-EN3-00	0.004–0.008	0.004–0.012	0.004–0.012	230 (195-260)	295 (260-330)
K6	Pxx-EN3-00	0.004–0.008	0.004–0.012	0.004–0.012	295 (260-330)	395 (260-490)
K7	Pxx-EN3-00	0.004–0.008	0.004–0.012	0.004–0.012	295 (260-330)	395 (260-490)
PM1	Pxx-EN3-00	0.004–0.008	0.004–0.012	0.004–0.012	165 (80-230)	-
PM2	Pxx-EN3-00	0.004–0.008	0.004–0.012	0.004–0.012	165 (80-230)	-
PM3	Pxx-EN3-00	0.004–0.008	0.004–0.012	0.004–0.012	165 (80-230)	-

SMG = Grupy materiałowe Seco

a_p = cal/owe

f = cal/obr.

v_c = stp/min

Wszystkie parametry są wartościami początkowymi

Parametry skrawania – Pxx-EN3-06 Metryczne

SMG		a_p (°)		f	v_c		
		$\varnothing < 9$	$\varnothing \geq 9$		H15	CP20	CP15
P1	Pxx-EN3-06	0,10-0,15	0,10-0,20	0,10-0,30	40 (30-60)	105 (90-120)	120 (90-150)
P2	Pxx-EN3-06	0,10-0,15	0,10-0,20	0,10-0,30	40 (30-60)	105 (90-120)	120 (90-150)
P3	Pxx-EN3-06	0,10-0,15	0,10-0,20	0,10-0,30	40 (30-60)	105 (90-120)	120 (90-150)
P4	Pxx-EN3-06	0,10-0,15	0,10-0,20	0,10-0,30	35 (25-40)	60 (40-70)	80 (60-100)
P5	Pxx-EN3-06	0,10-0,15	0,10-0,20	0,10-0,30	35 (25-40)	60 (40-70)	80 (60-100)
P6	Pxx-EN3-06	0,10-0,15	0,10-0,20	0,10-0,30	35 (25-40)	60 (40-70)	80 (60-100)
P7	Pxx-EN3-06	0,10-0,15	0,10-0,20	0,10-0,30	35 (25-40)	60 (40-70)	80 (60-100)
P8	Pxx-EN3-06	0,10-0,15	0,10-0,20	0,10-0,30	30 (25-40)	50 (30-60)	60 (40-70)
P11	Pxx-EN3-06	0,10-0,15	0,10-0,20	0,10-0,30	30 (25-40)	50 (30-60)	60 (40-70)
P12	Pxx-EN3-06	0,10-0,15	0,10-0,20	0,10-0,30	25 (20-30)	40 (25-45)	45 (30-55)
M1	Pxx-EN3-06	0,10-0,15	0,10-0,20	0,10-0,30	-	-	35 (25-40)
M2	Pxx-EN3-06	0,10-0,15	0,10-0,20	0,10-0,30	-	-	35 (25-40)
M3	Pxx-EN3-06	0,10-0,15	0,10-0,20	0,10-0,30	-	-	35 (25-40)
M4	Pxx-EN3-06	0,10-0,15	0,10-0,20	0,10-0,30	-	-	30 (25-40)
M5	Pxx-EN3-06	0,10-0,15	0,10-0,20	0,10-0,30	-	-	30 (25-40)
K1	Pxx-EN3-06	0,10-0,20	0,10-0,30	0,10-0,30	-	90 (80-100)	120 (80-150)
K2	Pxx-EN3-06	0,10-0,20	0,10-0,30	0,10-0,30	-	35 (25-50)	50 (25-70)
K3	Pxx-EN3-06	0,10-0,20	0,10-0,30	0,10-0,30	-	90 (80-100)	120 (80-150)
K4	Pxx-EN3-06	0,10-0,20	0,10-0,30	0,10-0,30	-	70 (60-80)	90 (80-100)
K5	Pxx-EN3-06	0,10-0,20	0,10-0,30	0,10-0,30	-	70 (60-80)	90 (80-100)
K6	Pxx-EN3-06	0,10-0,20	0,10-0,30	0,10-0,30	-	90 (80-100)	120 (80-150)
K7	Pxx-EN3-06	0,10-0,20	0,10-0,30	0,10-0,30	-	90 (80-100)	120 (80-150)
PM1	Pxx-EN3-06	0,10-0,20	0,10-0,30	0,10-0,30	-	50 (25-70)	-
PM2	Pxx-EN3-06	0,10-0,20	0,10-0,30	0,10-0,30	-	50 (25-70)	-
PM3	Pxx-EN3-06	0,10-0,20	0,10-0,30	0,10-0,30	-	50 (25-70)	-

SMG = Grupy materiałowe Seco

 a_p = mm

f = mm/obr

 v_c = m/min

Wszystkie parametry są wartościami początkowymi

Parametry skrawania – Pxx-E3-06 cale

SMG		$a_p (\varnothing)$		f	v_c		
		$\varnothing < 9$	$\varnothing \geq 9$		H15	CP20	CP15
P1	Pxx-EN3-06	0.004–0.006	0.004–0.008	0.004–0.012	130 (100-195)	345 (295-395)	395 (295-490)
P2	Pxx-EN3-06	0.004–0.006	0.004–0.008	0.004–0.012	130 (100-195)	345 (295-395)	395 (295-490)
P3	Pxx-EN3-06	0.004–0.006	0.004–0.008	0.004–0.012	130 (100-195)	345 (295-395)	395 (295-490)
P4	Pxx-EN3-06	0.004–0.006	0.004–0.008	0.004–0.012	115 (80-130)	195 (130-230)	260 (195-330)
P5	Pxx-EN3-06	0.004–0.006	0.004–0.008	0.004–0.012	115 (80-130)	195 (130-230)	260 (195-330)
P6	Pxx-EN3-06	0.004–0.006	0.004–0.008	0.004–0.012	115 (80-130)	195 (130-230)	260 (195-330)
P7	Pxx-EN3-06	0.004–0.006	0.004–0.008	0.004–0.012	115 (80-130)	195 (130-230)	260 (195-330)
P8	Pxx-EN3-06	0.004–0.006	0.004–0.008	0.004–0.012	100 (80-130)	165 (100-195)	195 (130-230)
P11	Pxx-EN3-06	0.004–0.006	0.004–0.008	0.004–0.012	100 (80-130)	165 (100-195)	195 (130-230)
P12	Pxx-EN3-06	0.004–0.006	0.004–0.008	0.004–0.012	80 (65-100)	130 (80-150)	150 (100-180)
M1	Pxx-EN3-06	0.004–0.006	0.004–0.008	0.004–0.012	–	–	115 (80-130)
M2	Pxx-EN3-06	0.004–0.006	0.004–0.008	0.004–0.012	–	–	115 (80-130)
M3	Pxx-EN3-06	0.004–0.006	0.004–0.008	0.004–0.012	–	–	115 (80-130)
M4	Pxx-EN3-06	0.004–0.006	0.004–0.008	0.004–0.012	–	–	100 (80-130)
M5	Pxx-EN3-06	0.004–0.006	0.004–0.008	0.004–0.012	–	–	100 (80-130)
K1	Pxx-EN3-06	0.004–0.008	0.004–0.012	0.004–0.012	–	295 (260-330)	395 (260-490)
K2	Pxx-EN3-06	0.004–0.008	0.004–0.012	0.004–0.012	–	115 (80-165)	165 (80-230)
K3	Pxx-EN3-06	0.004–0.008	0.004–0.012	0.004–0.012	–	295 (260-330)	395 (260-490)
K4	Pxx-EN3-06	0.004–0.008	0.004–0.012	0.004–0.012	–	230 (195-260)	295 (260-330)
K5	Pxx-EN3-06	0.004–0.008	0.004–0.012	0.004–0.012	–	230 (195-260)	295 (260-330)
K6	Pxx-EN3-06	0.004–0.008	0.004–0.012	0.004–0.012	–	295 (260-330)	395 (260-490)
K7	Pxx-EN3-06	0.004–0.008	0.004–0.012	0.004–0.012	–	295 (260-330)	395 (260-490)
PM1	Pxx-EN3-06	0.004–0.008	0.004–0.012	0.004–0.012	–	165 (80-230)	–
PM2	Pxx-EN3-06	0.004–0.008	0.004–0.012	0.004–0.012	–	165 (80-230)	–
PM3	Pxx-EN3-06	0.004–0.008	0.004–0.012	0.004–0.012	–	165 (80-230)	–

SMG = Grupy materiałowe Seco

a_p = calowe

f = cal/obr.

v_c = stp/min

Wszystkie parametry są wartościami początkowymi

Wstęp

Wiercenie

Rozwiercanie

Wytaczanie

Załącznik

Parametry skrawania – Pxx-EN3-12 Metryczne

SMG		a_p (°)		f	v_c		
		$\varnothing < 9$	$\varnothing \geq 9$		H15	CP20	CP15
P1	Pxx-EN3-12	0,10-0,15	0,10-0,20	0,10-0,30	40 (30-60)	105 (90-120)	120 (90-150)
P2	Pxx-EN3-12	0,10-0,15	0,10-0,20	0,10-0,30	40 (30-60)	105 (90-120)	120 (90-150)
P3	Pxx-EN3-12	0,10-0,15	0,10-0,20	0,10-0,30	40 (30-60)	105 (90-120)	120 (90-150)
P4	Pxx-EN3-12	0,10-0,15	0,10-0,20	0,10-0,30	35 (25-40)	60 (40-70)	80 (60-100)
P5	Pxx-EN3-12	0,10-0,15	0,10-0,20	0,10-0,30	35 (25-40)	60 (40-70)	80 (60-100)
P6	Pxx-EN3-12	0,10-0,15	0,10-0,20	0,10-0,30	35 (25-40)	60 (40-70)	80 (60-100)
P7	Pxx-EN3-12	0,10-0,15	0,10-0,20	0,10-0,30	35 (25-40)	60 (40-70)	80 (60-100)
P8	Pxx-EN3-12	0,10-0,15	0,10-0,20	0,10-0,30	30 (25-40)	50 (30-60)	60 (40-70)
P11	Pxx-EN3-12	0,10-0,15	0,10-0,20	0,10-0,30	30 (25-40)	50 (30-60)	60 (40-70)
P12	Pxx-EN3-12	0,10-0,15	0,10-0,20	0,10-0,30	25 (20-30)	40 (25-45)	45 (30-55)
K1	Pxx-EN3-12	0,10-0,20	0,10-0,30	0,10-0,30	-	90 (80-100)	-
K3	Pxx-EN3-12	0,10-0,20	0,10-0,30	0,10-0,30	-	90 (80-100)	-
K4	Pxx-EN3-12	0,10-0,20	0,10-0,30	0,10-0,30	-	70 (60-80)	-
K5	Pxx-EN3-12	0,10-0,20	0,10-0,30	0,10-0,30	-	70 (60-80)	-
PM1	Pxx-EN3-12	0,10-0,20	0,10-0,30	0,10-0,30	-	50 (25-70)	-
PM2	Pxx-EN3-12	0,10-0,20	0,10-0,30	0,10-0,30	-	50 (25-70)	-
PM3	Pxx-EN3-12	0,10-0,20	0,10-0,30	0,10-0,30	-	50 (25-70)	-

SMG = Grupy materiałowe Seco

 a_p = mm

f = mm/obr

 v_c = m/min

Wszystkie parametry są wartościami początkowymi

Parametry skrawania – Pxx-EN3-12 cale

SMG		a_p (°)		f	v_c		
		$\varnothing < 9$	$\varnothing \geq 9$		H15	CP20	CP15
P1	Pxx-EN3-12	0,004-0,006	0,004-0,008	0,004-0,012	130 (100-195)	345 (295-395)	395 (295-490)
P2	Pxx-EN3-12	0,004-0,006	0,004-0,008	0,004-0,012	130 (100-195)	345 (295-395)	395 (295-490)
P3	Pxx-EN3-12	0,004-0,006	0,004-0,008	0,004-0,012	130 (100-195)	345 (295-395)	395 (295-490)
P4	Pxx-EN3-12	0,004-0,006	0,004-0,008	0,004-0,012	115 (80-130)	195 (130-230)	260 (195-330)
P5	Pxx-EN3-12	0,004-0,006	0,004-0,008	0,004-0,012	115 (80-130)	195 (130-230)	260 (195-330)
P6	Pxx-EN3-12	0,004-0,006	0,004-0,008	0,004-0,012	115 (80-130)	195 (130-230)	260 (195-330)
P7	Pxx-EN3-12	0,004-0,006	0,004-0,008	0,004-0,012	115 (80-130)	195 (130-230)	260 (195-330)
P8	Pxx-EN3-12	0,004-0,006	0,004-0,008	0,004-0,012	100 (80-130)	165 (100-195)	195 (130-230)
P11	Pxx-EN3-12	0,004-0,006	0,004-0,008	0,004-0,012	100 (80-130)	165 (100-195)	195 (130-230)
P12	Pxx-EN3-12	0,004-0,006	0,004-0,008	0,004-0,012	80 (65-100)	130 (80-150)	150 (100-180)
K1	Pxx-EN3-12	0,004-0,008	0,004-0,012	0,004-0,012	-	295 (260-330)	-
K3	Pxx-EN3-12	0,004-0,008	0,004-0,012	0,004-0,012	-	295 (260-330)	-
K4	Pxx-EN3-12	0,004-0,008	0,004-0,012	0,004-0,012	-	230 (195-260)	-
K5	Pxx-EN3-12	0,004-0,008	0,004-0,012	0,004-0,012	-	230 (195-260)	-
PM1	Pxx-EN3-12	0,004-0,008	0,004-0,012	0,004-0,012	-	165 (80-230)	-
PM2	Pxx-EN3-12	0,004-0,008	0,004-0,012	0,004-0,012	-	165 (80-230)	-
PM3	Pxx-EN3-12	0,004-0,008	0,004-0,012	0,004-0,012	-	165 (80-230)	-

SMG = Grupy materiałowe Seco

 a_p = calowe

f = cal/obr.



 v_c = stp/min

Wszystkie parametry są wartościami początkowymi

Instrukcje dotyczące regulacji

Wstęp		Poluzować dwie śruby nastawne (7) o 1/4 obrotu.
Wiercenie		Poluzować dwie śruby mocujące (5).
Rozwiercanie		Dokładnie oczyścić gniazdo płytki, zmień krawędź (2) lub wymień płytkę.
Wytaczanie		Mocno docisnąć płytkę w kierunku oporu osiowego i kulek ustalających (6).
Załącznik		Ostrożnie dokręcić śruby mocujące. (Trzymać klucz za krótszy koniec)
		Ustawić czujnik na zero wykorzystując cylindryczną powierzchnię prowadnic (3).

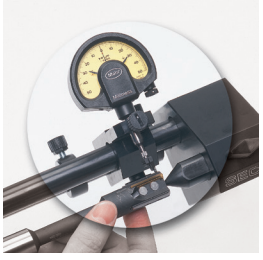
Instrukcje dotyczące regulacji

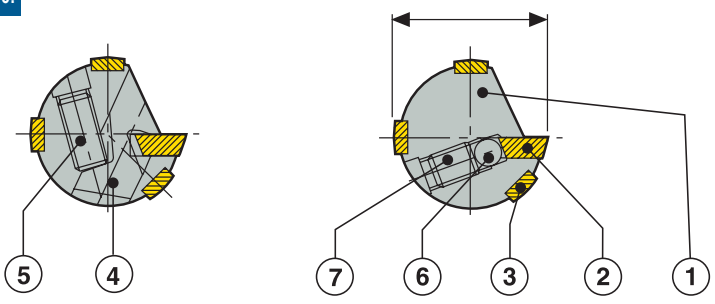
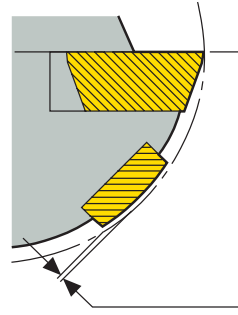
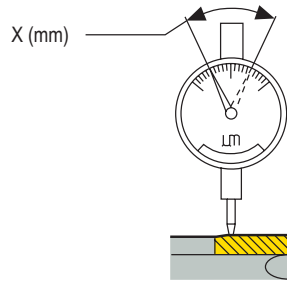
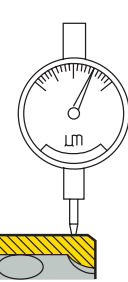
<p>7.</p>		<p>Ustawić tylną część płytki na średnicę zachowując zbieżność ostrza 0,01 mm/10 mm (0.0004" na 0.394") wzdłuż płytki (patrz rys. 2).</p>																												
<p>8.</p>		<p>Ustawić czujnik na zero wykorzystując cylindryczną powierzchnię prowadnic (3).</p>																												
<p>9.</p>		<p>Ustawić przednią część płytki o 0,02 mm lub 0,015 mm (0.0008" lub 0.0006") powyżej prowadnic (3) czujnik A, patrz rysunek 1. Sprawdź ponownie ustawienie zbieżności (etapy 6 i 7) czujnik B.</p>																												
<p>10.</p>	<div style="display: flex; justify-content: space-between;"> <div style="width: 45%;">  <p>Uwaga: Jeśli wymagana średnica została przekroczona podczas ustawiania, cały proces należy powtórzyć od początku celem eliminacji luzów na śrubach regulacyjnych.</p> </div> <div style="width: 45%;">  <p>rys. 1</p> <p>0,015 mm ($\varnothing \leq 10$ mm) 0,020 mm ($\varnothing > 10$ mm) Wskazanie czujnika A dla ustawienia \varnothing</p> <p>0,0006" ($\varnothing \leq 0,394$") 0,0008" ($\varnothing > 0,394$") Wskazanie czujnika A dla ustawienia \varnothing</p> </div> </div> <div style="display: flex; justify-content: space-around; margin-top: 20px;"> <div style="text-align: center;"> <p>Czujnik B</p>  </div> <div style="text-align: center;"> <p>Czujnik A</p>  </div> </div> <p style="text-align: center;">rys. 2</p> <ul style="list-style-type: none"> • Jednostka czujnika = 1 μm (39 μcal) • Wskazania przedniego i tylnego czujnika są prawidłowe, gdy czujniki są ustawione na zero na sąsiedniej prowadnicy • Wskazania tylnego czujnika obliczone dla zbieżności ostrza 1 μm/mm (0.0004") 																													
<table border="1" style="width: 100%; border-collapse: collapse;"> <thead> <tr style="background-color: #0056b3; color: white;"> <th colspan="4">Tabela ustawień</th> </tr> <tr style="background-color: #0056b3; color: white;"> <th>Zakres średnic mm (cale)</th> <th>Wielkość płytki:</th> <th>Czujnik czołowy A</th> <th>Czujnik tylni B</th> </tr> </thead> <tbody> <tr> <td>6,875-8,749 (0.271-0.344")</td> <td>P0</td> <td>+15</td> <td>-5</td> </tr> <tr> <td>8,750-10,000 (0.344-0.394")</td> <td>P1</td> <td>+15</td> <td>-5</td> </tr> <tr> <td>10,001-12,749 (0.394-0.502")</td> <td>P1</td> <td>+20</td> <td>0</td> </tr> <tr> <td>12,750-19,499 (0.502-0.768")</td> <td>P2</td> <td>+20</td> <td>0</td> </tr> <tr> <td>19,500-60,500 (0.768-2.382")</td> <td>P4</td> <td>+20</td> <td>0</td> </tr> </tbody> </table>			Tabela ustawień				Zakres średnic mm (cale)	Wielkość płytki:	Czujnik czołowy A	Czujnik tylni B	6,875-8,749 (0.271-0.344")	P0	+15	-5	8,750-10,000 (0.344-0.394")	P1	+15	-5	10,001-12,749 (0.394-0.502")	P1	+20	0	12,750-19,499 (0.502-0.768")	P2	+20	0	19,500-60,500 (0.768-2.382")	P4	+20	0
Tabela ustawień																														
Zakres średnic mm (cale)	Wielkość płytki:	Czujnik czołowy A	Czujnik tylni B																											
6,875-8,749 (0.271-0.344")	P0	+15	-5																											
8,750-10,000 (0.344-0.394")	P1	+15	-5																											
10,001-12,749 (0.394-0.502")	P1	+20	0																											
12,750-19,499 (0.502-0.768")	P2	+20	0																											
19,500-60,500 (0.768-2.382")	P4	+20	0																											

Rozwiązywanie problemów

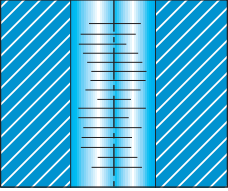
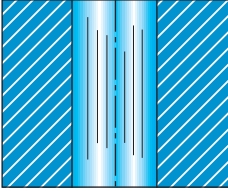
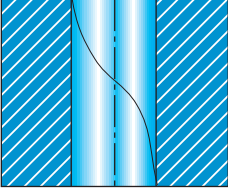
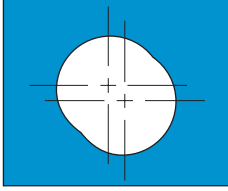
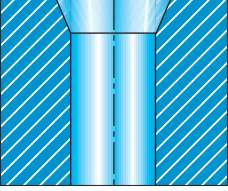
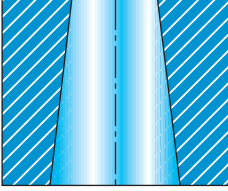
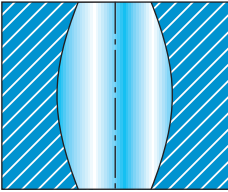
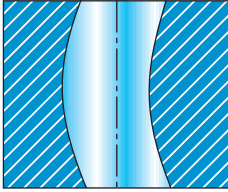
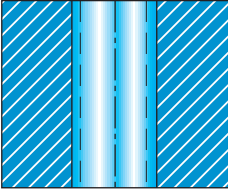
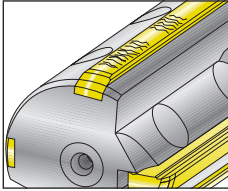
<p>Zła jakość powierzchni</p> <ul style="list-style-type: none"> • Sprawdź naddatek materiału • Poprawić warunki chłodzenia (wylot, ciśnienie, jakość) • Zredukuj posuw • Zmienić ostrze (zła geometria prowadząca lub kąt natarcia) • Sprawdzić położenie osiowe ostrza 	<p>Karby</p> <ul style="list-style-type: none"> • Poprawić centrowanie (detal/narzędzie) • Skorygować zbieżność ostrza 
<p>Ślady wycofywania</p> <ul style="list-style-type: none"> • Poprawić warunki chłodzenia (wylot, ciśnienie, jakość) • Poprawić centrowanie (detal/narzędzie) • Skorygować zbieżność ostrza 	<p>Mimośród/Owal</p> <ul style="list-style-type: none"> • Poprawić mocowanie (deformacja części) • Sprawdzić naddatek na obróbkę • Poprawić centrowanie (detal/narzędzie) • Sprawdzić położenie osiowe ostrza 
<p>Stożkowate wejście</p> <ul style="list-style-type: none"> • Zmniejszyć posuw • Poprawić centrowanie (detal/narzędzie) • Skorygować zbieżność ostrza • Zredukować bicie promieniowe 	<p>Otwór stożkowy</p> <ul style="list-style-type: none"> • Poprawić centrowanie (detal/narzędzie) • Skorygować zbieżność ostrza 
<p>Zniekształcony otwór</p> <ul style="list-style-type: none"> • Poprawić mocowanie (deformacja części) 	<p>Wyboczenie</p> <ul style="list-style-type: none"> • Zmienić ostrze (zła geometria wejścia) • Sprawdzić położenie osiowe ostrza 
<p>Za duża średnica</p> <ul style="list-style-type: none"> • Poprawić centrowanie (detal/narzędzie) • Wyregulować średnicę (zbyt duża) 	<p>Narost na listwach prowadzących</p> <ul style="list-style-type: none"> • Poprawić warunki chłodzenia (wylot, ciśnienie, jakość) • Skorygować średnicę (zbyt mała) 

Wstęp

Wiercenie

Rozwiercanie

Wyłaczanie

Załącznik



Xfix™

Rozwiertaki Xfix™ o wielu ostrzach i dużej średnicy zapewniają najwyższą możliwą wydajność i precyzję podczas obróbki otworów.

- Głębokości otworu do 6,5xD w zakresie średnic 9,5–154,5 mm (2.03”–6.083”)
- Szybka i łatwa regulacja — do ustawienia średnicy wymagana jest tylko jedna śruba na ostrze
- Dokładny system regulacji pozwalający uzyskać wąskie tolerancje pomiędzy 16 a 25 μm (.0006–.0010”)
- Płytki są wyposażone w cztery lub osiem ponumerowanych krawędzi

Przegląd asortymentu

	Zakres \varnothing	Głębokość rozwiercania	Tolerancja \varnothing otworu	Średnice pośrednie	Wykończenie powierzchni
<p>Xfix™</p> 	39,500-154,500 mm (1.5551-6.0827")	2,5-6,5 x D	IT 6	Tak, dostępne w ramach projektu niestandardowego	R_a 0,8-1,2 μ m (R_a 31-47 μ in)

Xfix™ to specjalnie opracowany program rozwiertaków Seco przeznaczonych do dużych \varnothing 39,5 - 154,5 mm (1.555" – 6.083"). Konstrukcja zawiera regulowane i wymienne płytki, które zapewniają IT 6 precyzyjną tolerancję, a także wbudowany regulowany adapter bicia gwarantujący jakość komponentów. Konstrukcja wielostrzowa z podatnymi prowadnicami oferująca maksymalną stabilność i wydajność podczas operacji rozwiercania dużej średnicy.

Wstęp

Wiercenie

Rozwiercanie

Wytaczanie

Zalącznik

Szczegóły

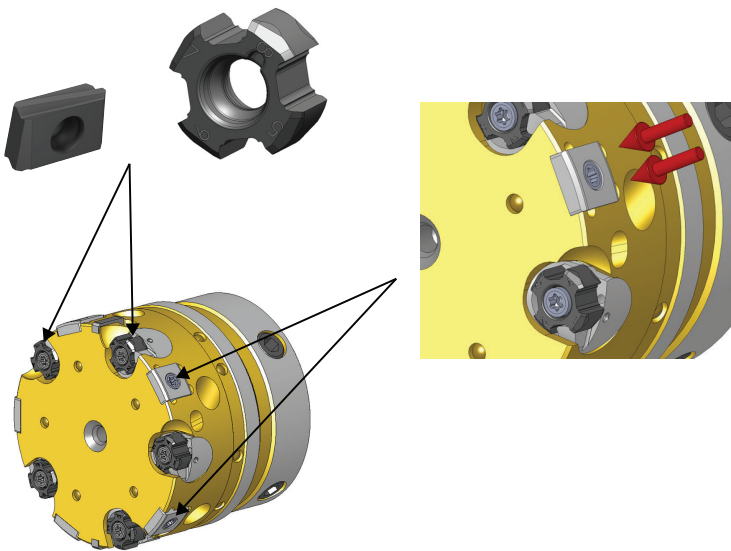
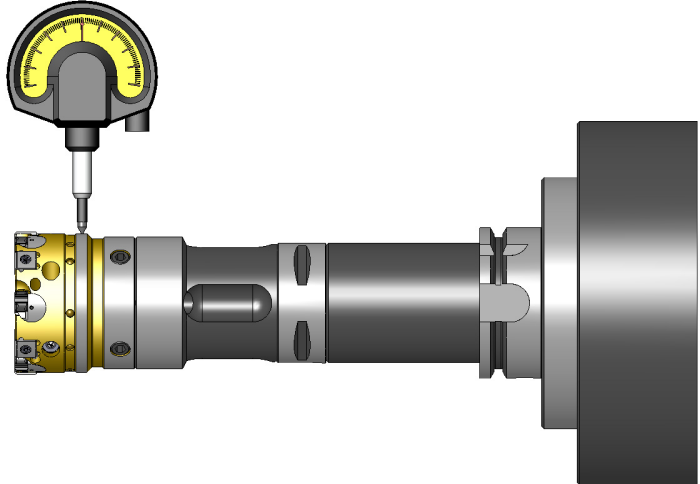
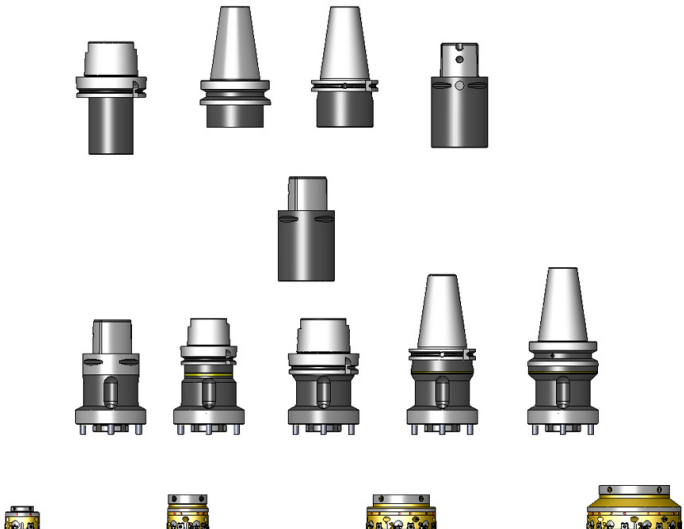
<ul style="list-style-type: none"> • 4 lub 8 ostrzy, optymalizacja we wszystkich materiałach • Stabilny system mocowania • Łatwa regulacja za pomocą jednej śruby regulacyjnej • Duży asortyment gatunków i geometrii do różnych zastosowań <ul style="list-style-type: none"> • Opatentowany system podatnych przewodnic poprawiający stabilność • Smarowanie przewodnic celem poprawy wydajności 		<p>Wstęp</p>
<ul style="list-style-type: none"> • Zintegrowany adapter do kompensacji bicia 		<p>Wiercenie</p>
<ul style="list-style-type: none"> • Asortyment opravek oraz przedłuzeek dla systemów modułowych zwiększający elastyczność stosowania 		<p>Rozwiercanie</p>
		<p>Wyłaczanie</p>
		<p>Załącznik</p>

Oznaczenia

Adaptory

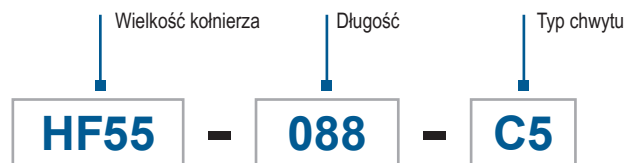

Standardowe głowice

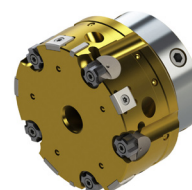
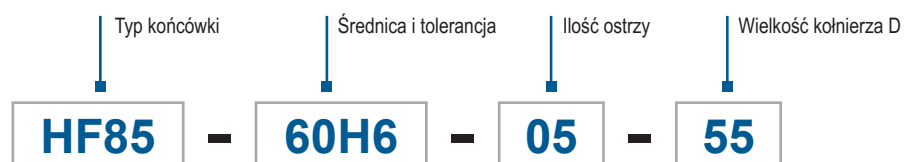

Średnice pośrednie

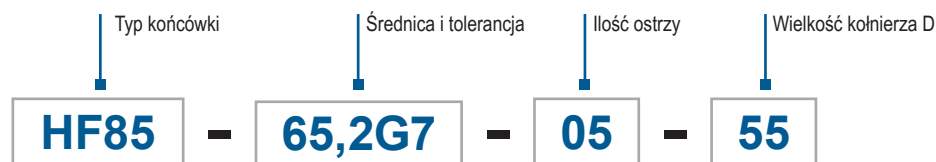

Typy głowic:

- HF85, otwory przelotowe, materiał dający krótki wiór
- HF85B, otwory nieprzelotowe, materiał dający krótki wiór
- HF86, otwory przelotowe, wszystkie materiały
- HF86B, otwory nieprzelotowe, wszystkie materiały

Płytki

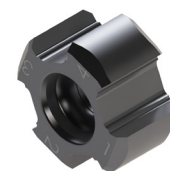
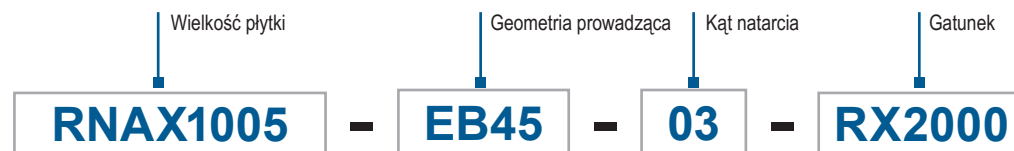

Płytki RNAX dla głowic Xfix HF85 i HF 85B

Płytki

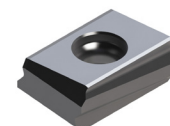
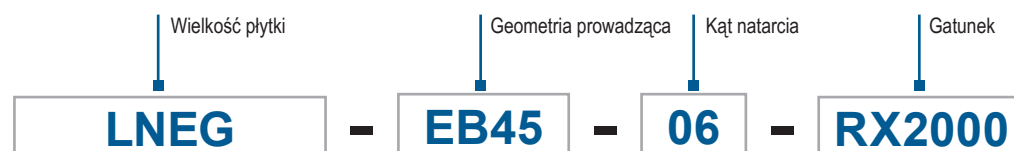

Płytki LNEG dla głowic Xfix HF86 i HF86B

RNAX

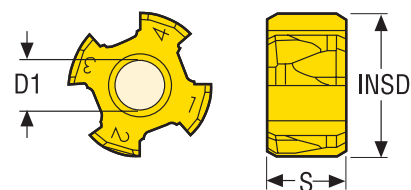

Oznaczenie	Płytki	INSD		S		D1		Gatunki		Kąt natarcia
		mm	Cal.	mm	Cal.	mm	Cal.	RX1500	RX2000	
RNAX1005-EB1570-03	RNAX	10,0	0,394	5,5	0,217	3,5	0,138	02687601	02687603	3°
RNAX1005-EB45-03	RNAX	10,0	0,394	5,5	0,217	3,5	0,138	02687600	02688608	3°
RNAX1005-EB845-03	RNAX	10,0	0,394	5,5	0,217	3,5	0,138	02687593	02688606	3°

LNEG

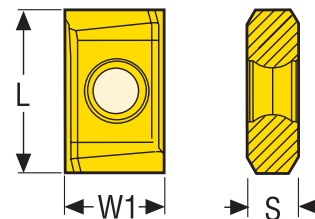

Oznaczenie	Płytki	L		S		W1		Gatunki		Kąt natarcia	
		mm	Cal.	mm	Cal.	mm	Cal.	RX1500	RX2000		CF
LNEG1003-EB45-03	LNEG	10,0	0,394	3,5	0,138	6,35	0,25	02781311		3°	
LNEG1003-EB45-06	LNEG	10,0	0,394	3,5	0,138	6,35	0,25	02904277	02781313	02904276	6°
LNEG1003-EB845-03	LNEG	10,0	0,394	3,5	0,138	6,35	0,25	02781314			3°
LNEG1003-EB845-06	LNEG	10,0	0,394	3,5	0,138	6,35	0,25	02781315			6°

Geometria prowadząca

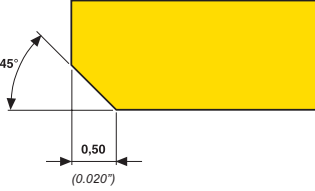
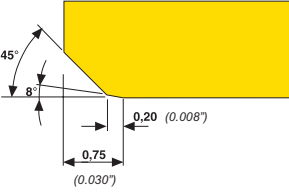
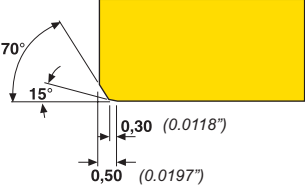
Geometria prowadząca EB45 – zastosowanie	
<p>Kontrola wióra +++ Gładkość powierzchni + R_a 1,2–2 μm (gładkość powierzchni + R_a 0.047–0.0787 μcala) Geometria pierwszego wyboru</p>	
Geometria prowadząca EB845 — zastosowanie	
<p>Kontrola wióra ++ Gładkość powierzchni +++ R_a 0,4–1,2 μm (gładkość powierzchni +++ R_a 0,0157–0 047 μcala)</p>	
Geometria prowadząca EB1570 — zastosowanie	
<p>Kontrola wióra ++ Gładkość powierzchni ++ R_a 0,8–1,6 μm (gładkość powierzchni ++ R_a 0.031–0.0630 μcala) Stabilność przy długich wysięgach +++</p>	

Wstęp

Wiercenie



Rozwiercanie

Wytaczanie

Załącznik

Geometria prowadząca

Gatunki

Gatunki		
	RX1500	Pokrywany Cermet Gatunek odporny na ścieralnie do optymalizacji wydajności obróbki stali i żeliwa.
	RX2000	Pokrywany Węglik o wysokiej wydajności odpowiedni do wszystkich materiałów..
	CF	Cermet Gatunek odporny na ocieranie do optymalizacji wydajności obróbki stali.

HF85

Głowice do płytek RNAX, otwór przelotowy \varnothing 39,5-59,499 mm / 1.555-2.342"

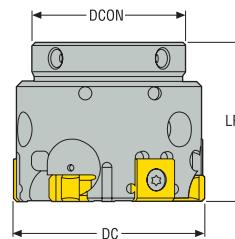
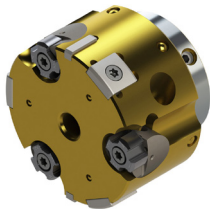

- Płytki, gatunki i geometry patrz str. 429-431
- Parametry skrawania, patrz strona (strony) 456-463

Oznaczenie	DCN	DCX	LFS	DCON	Waga	Płytki
	mm Cal.	mm Cal.	mm Cal.	mm Cal.	kg lbs	
HF85-39.5/44.499-03-32	39,5 1.555	44,499 1.752	33,0 1.299	32,0 1.260	0,41 0.900	3 RNAX1005...
HF85-44.5/49.499-03-32	44,5 1.752	49,499 1.949	33,0 1.299	32,0 1.260	0,51 1.120	3 RNAX1005...
HF85-49.5/54.499-03-32	49,5 1.949	54,499 2.146	33,0 1.299	32,0 1.260	0,62 1.370	3 RNAX1005...
HF85-54.5/59.499-03-32	54,5 2.146	59,499 2.342	33,0 1.299	32,0 1.260	0,74 1.630	3 RNAX1005...

Części zamienne, zawarte w dostawie

Do głowicy	Śruba regulacyjna	Wkładka	Śruba mocująca	Śruba do płytki	Klucz (Typu flaga)	Klucz ustawczy	Docisk mocujący
HF85 03-32	SH4075S	CARTCYHF16	LDH4010	C03010-T09P	H2.0-2D	2SMS795	B6027

Akcesoria

Do głowicy	Klucz dynamometryczny	Klucz Torx do śruby mocującej płytkę / wkładkę
HF85 03-32	H00-2020	T00-09P20

Uwaga

Klucz dynamometryczny H00-2020 dla śruby mocującej

Klucz dynamometryczny T00-09P20 dla śruby mocującej

Wielk. mom. T00-09P20: 2 Nm.

Wielk. mom. H00-2020: 2 Nm.

HF85B

Głowice do płytek RNAX, otwór nieprzelotowy \varnothing 39,5-59,499 mm / 1.555-2.342"

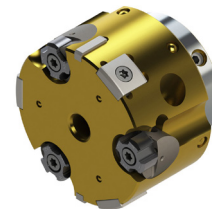
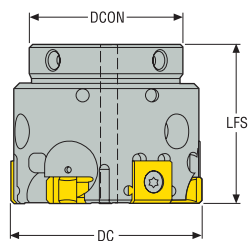

- Płytki, gatunki i geometry patrz str. 429-431
- Parametry skrawania, patrz strona (strony) 456-463

Oznaczenie	DCN	DCX	LFS	DCON	Waga	Płytki
	mm Cal.	mm Cal.	mm Cal.	mm Cal.	kg lbs	
HF85B-39.5/44.499-03-32	39,5 1.555	44,499 1.752	33,0 1.299	32,0 1.260	0,41 0.900	3
HF85B-44.5/49.499-03-32	44,5 1.752	49,499 1.949	33,0 1.299	32,0 1.260	0,51 1.120	3
HF85B-49.5/54.499-03-32	49,5 1.949	54,499 2.146	33,0 1.299	32,0 1.260	0,62 1.370	3
HF85B-54.5/59.499-03-32	54,5 2.146	59,499 2.342	33,0 1.299	32,0 1.260	0,74 1.630	3

Części zamienne, zawarte w dostawie

Do głowicy	Śruba regulacyjna	Wkładka	Śruba mocująca	Śruba do płytki	Klucz (Typu flaga)	Klucz ustawczy	Docisk mocujący
HF85B 03-32	SH4075S	CARTCYHF16B	LDH4010	C03010-T09P	H2.0-2D	2SMS795	B6027

Akcesoria

Do głowicy	Klucz dynamometryczny	Klucz Torx do śruby mocującej płytkę / wkładkę
HF85B 03-32	H00-2020	T00-09P20

Uwaga

Klucz dynamometryczny H00-2020 dla śruby mocującej

Klucz dynamometryczny T00-09P20 dla śruby mocującej

Wielk. mom. T00-09P20: 2 Nm.

Wielk. mom. H00-2020: 2 Nm.

HF86

Głowice do płytek LNEG, otwór przelotowy \varnothing 39,5-59,499 mm / 1.555-2.342"

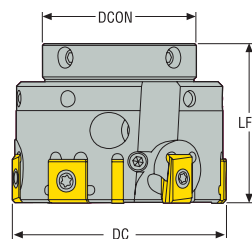
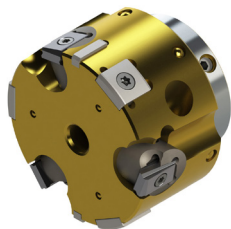

- Płytki, gatunki i geometry patrz str. 429-431
- Parametry skrawania, patrz strona (strony) 456-463

Oznaczenie	DCN	DCX	LFS	DCON	Waga	Płytki
	mm Cal.	mm Cal.	mm Cal.	mm Cal.	kg lbs	
HF86-39.5/44.499-03-32	39,5 1.555	44,499 1.752	33,0 1.299	32,0 1.260	0,41 0.900	3 LNEG1003...
HF86-44.5/49.499-03-32	44,5 1.752	49,499 1.949	33,0 1.299	32,0 1.260	0,51 1.120	3 LNEG1003...
HF86-49.5/54.499-03-32	49,5 1.949	54,499 2.146	33,0 1.299	32,0 1.260	0,62 1.370	3 LNEG1003...
HF86-54.5/59.499-03-32	54,5 2.146	59,499 2.342	33,0 1.299	32,0 1.260	0,74 1.630	3 LNEG1003...

Części zamienne, zawarte w dostawie

Do głowicy	Śruba regulacyjna	Wkładka	Śruba mocująca	Śruba do płytki	Klucz (Typu flaga)	Klucz ustawczy	Docisk mocujący
HF86 03-32	SH4075S	CARTCYLN16	LDH4010	C02506-T07P	H2.0-2D	2SMS795	B6027

Akcesoria

Do głowicy	Klucz dynamometryczny	Klucz Torx do śruby mocującej płytkę / wkładkę
HF86 03-32	H00-2020	T00-07P09

Uwaga

Klucz dynamometryczny H00-2020 dla śruby mocującej

Klucz dynamometryczny T00-07P09 dla śruby mocującej

Wielk. mom. T00-07P09: 0,9 Nm.

Wielk. mom. H00-2020: 2 Nm.

HF86B

Głowice do płytek LNEG, otwór nieprzelotowy \varnothing 39,5-59,499 mm / 1.555-2.342"

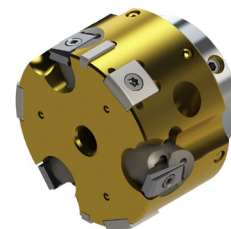
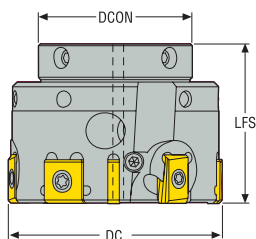

- Płytki, gatunki i geometry patrz str. 429-431
- Parametry skrawania, patrz strona (strony) 456-463

Oznaczenie	DCN	DCX	LFS	DCON	Waga	Płytki
	mm Cal.	mm Cal.	mm Cal.	mm Cal.	kg lbs	
HF86B-39.5/44.499-03-32	39,5 1.555	44,499 1.752	33,0 1.299	32,0 1.260	0,41 0.900	3
HF86B-44.5/49.499-03-32	44,5 1.752	49,499 1.949	33,0 1.299	32,0 1.260	0,51 1.120	3
HF86B-49.5/54.499-03-32	49,5 1.949	54,499 2.146	33,0 1.299	32,0 1.260	0,62 1.370	3
HF86B-54.5/59.499-03-32	54,5 2.146	59,499 2.342	33,0 1.299	32,0 1.260	0,74 1.630	3

Części zamienne, zawarte w dostawie

Do głowicy	Śruba regulacyjna	Wkładka	Śruba mocująca	Śruba do płytki	Klucz (Typu flaga)	Klucz ustawczy	Docisk mocujący
HF86B 03-32	SH4075S	CARTCYLN16B	LDH4010	C02506-T07P	H2.0-2D	2SMS795	B6027

Akcesoria

Do głowicy	Klucz dynamometryczny	Klucz Torx do śruby mocującej płytkę / wkładkę
HF86B 03-32	H00-2020	T00-07P09

Uwaga

Klucz dynamometryczny H00-2020 dla śruby mocującej

Klucz dynamometryczny T00-07P09 dla śruby mocującej

Wielk. mom. T00-07P09: 0,9 Nm.

Wielk. mom. H00-2020: 2 Nm.

HF32

Oprawki Seco-Capto™ do \varnothing 39,5-59,499 mm

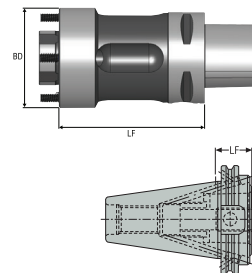
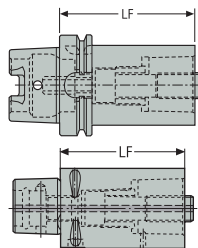

Oznaczenie Oprawka rozwiertaka	Numer produktu	LF min	LF max	Stożek	BD	Waga
		mm	mm	mm	mm	kg
HF32-050-C3	02688610	-	50	C3	32	0,3
HF32...HSKA63	-	65	245	HSK-A63	32	0,0
HF32...HSKA80	-	100	209	HSK-A80	32	0,0
HF32...HSKA100	-	70	245	HSK-A100	32	0,0
HF32...DIN40ADB	-	60	252	DIN40ADB	32	0,0
HF32...DIN50ADB	-	60	317	DIN50ADB	32	0,0
HF32...BT40ADB	-	65	252	BT40ADB	32	0,0
HF32...BT50ADB	-	75	317	BT50ADB	32	0,0

Oprawki i przedłużenia dla HF32-050-C3 (więcej informacji w katalogu Seco Systemy Narzędziowe).

Oznaczenie Chwył	Numer produktu	LF	Stożek	Wielkość Seco-Capto	Waga
		mm			kg
HA10-C3-032-080	10197961	80	HSK-A100	C3	2,5
HA06-C4-040-080	10197964	80	HSK-A63	C4	1,2
C3-390B.140-40030	02924104	30	DIN40	C3	0,8
C3-390B.55-40030	02925959	30	BT40	C3	0,9
C3-390B.55-40060	02925960	60	BT40	C3	1,1
C3-390B.140-50030	02924106	30	DIN50	C3	2,6
C3-390B.140-50060	02924107	60	DIN50	C3	2,7
C3-390B.58-50040	02925961	40	BT50	C3	3,5
C3-390B.58-50070	02925962	70	BT50	C3	3,7

Oznaczenie Przedłużka	Numer produktu	LF	Stożek	Wielkość Seco-Capto	Waga
		mm			kg
C3-391.01-32060A	75039884	-	C3	C3	0,34
C3-391.01-32080A	00090847	-	C3	C3	0,5
C4-391.02-32055A	75039889	-	C4	C3	0,42
C4-391.02-32070A	02535687	-	C4	C3	0,56
C5-391.02-32060A	75039890	-	C5	C3	0,64
C6-391.02-32070A	75039892	-	C6	C3	1,06

HF32

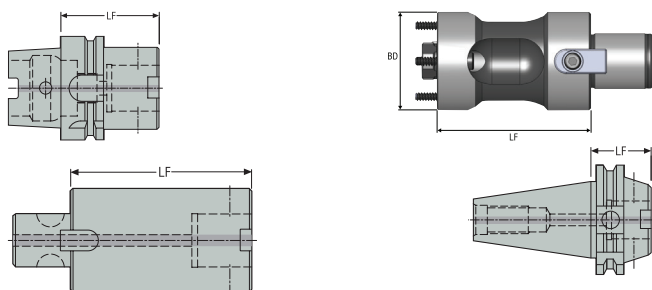
Graflex® oprawka dla \varnothing 39,5-59,499 mm

Oznaczenie Oprawka rozwiertaka	Numer produktu	LF min	LF max	Stożek	BD	Waga
		mm	mm		mm	kg
HF32-050-G3	02698870	–	50	G3	32	0,4
HF32...HKA63	–	65	245	HSK-A63	32	0,0
HF32...HKA80	–	100	209	HSK-A80	32	0,0
HF32...HKA100	–	70	245	HSK-A100	32	0,0
HF32...DIN40ADB	–	60	252	DIN40ADB	32	0,0
HF32...DIN50ADB	–	60	317	DIN50ADB	32	0,0
HF32...BT40ADB	–	65	252	BT40ADB	32	0,0
HF32...BT50ADB	–	75	317	BT50ADB	32	0,0

Oprawki i przedłużenia dla HF32-050-G3 (więcej informacji w katalogu Seco Systemy Narzędziowe).

Oznaczenie Chwył	Numer produktu	LF	Stożek	Wielk. Graflex	Waga
		mm			kg
EM93044011850	00086918	50	HSK-A63	G3	0,73
EM93064011855	00086925	55	HSK-A100	G3	2,1
EM34694011835	02420097	35	DIN40	G3	0,91
EM346940118100	02503298	100	DIN40	G3	1,22
EM34144011840	02503366	40	BT40	G3	1,07
EM341440118100	02503367	100	BT40	G3	1,31
EM34714011835	02503307	35	DIN50	G3	2,67
EM34164011845	02503376	45	BT50	G3	3,58
EM341640118120	02503377	120	BT50	G3	3,9

Oznaczenie Przedłużka	Numer produktu	LF	Stożek	Wielk. Graflex	Waga
		mm			kg
M402330	00056758	–	G3	G3	0,24
M402331	75056759	–	G3	G3	0,36

Wstęp

Wiercenie

Rozwiercanie

Wytaczanie

Załącznik

HF85



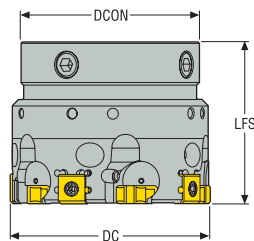
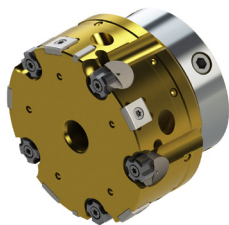



Głowice do płytek RNAX, otwór przelotowy \varnothing 59,5-84,499 mm / 2.343-3.327"





- Płytki, gatunki i geometry patrz str. 429-431
- Parametry skrawania, patrz strona (strony) 456-463

Oznaczenie	DCN	DCX	LFS	DCON	Waga	Płytki
	mm Cal.	mm Cal.	mm Cal.	mm Cal.	kg lbs	
HF85-59.5/64.499-05-55	59,5 2.343	64,499 2.539	50,0 1.969	55,0 2.165	1,3 2.870	5 RNAX1005...
HF85-64.5/69.499-05-55	64,5 2.539	69,499 2.736	50,0 1.969	55,0 2.165	1,5 3.310	5 RNAX1005...
HF85-69.5/74.499-05-55	69,5 2.736	74,499 2.933	50,0 1.969	55,0 2.165	1,75 3.860	5 RNAX1005...
HF85-74.5/79.499-05-55	74,5 2.933	79,499 3.130	50,0 1.969	55,0 2.165	2,0 4.410	5 RNAX1005...
HF85-79.5/84.499-05-55	79,5 3.130	84,499 3.327	50,0 1.969	55,0 2.165	2,2 4.850	5 RNAX1005...

Części zamienne, zawarte w dostawie

Do głowicy	Śruba regulacyjna	Wkładka	Śruba mocująca	Śruba do płytki	Klucz (Typu flaga)	Klucz ustawczy	Docisk mocujący
HF85 05-55	 SH4075S	 CARTCYHF20	 LDH4012	 C03010-T09P	 H2.0-2D	 4SMS795	 B6027

Akcesoria

Do głowicy	Klucz dynamometryczny	Klucz Torx do śruby mocującej płytkę / wkładkę
HF85 05-55	 H00-2020	 T00-09P20

Uwaga

Klucz dynamometryczny H00-2020 dla śruby mocującej

Klucz dynamometryczny T00-09P20 dla śruby mocującej

Wielk. mom. T00-09P20: 2 Nm.

Wielk. mom. H00-2020: 2 Nm.

HF85B

Głowice do płytek RNAX, otwór nieprzelotowy \varnothing 59,5-84,499 mm / 2.343-3.327"

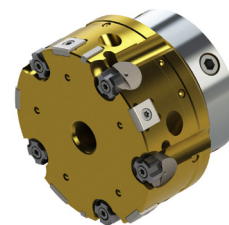
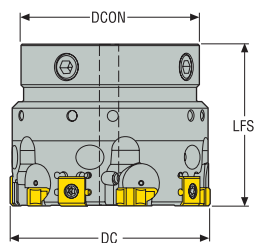

- Płytki, gatunki i geometry patrz str. 429-431
- Parametry skrawania, patrz strona (strony) 456-463

Oznaczenie	DCN	DCX	LFS	DCON	Waga	Płytki
	mm Cal.	mm Cal.	mm Cal.	mm Cal.	kg lbs	
HF85B-59.5/64.499-05-55	59,5 2.343	64,499 2.539	50,0 1.969	55,0 2.165	1,3 2.870	5 RNAX1005...
HF85B-64.5/69.499-05-55	64,5 2.539	69,499 2.736	50,0 1.969	55,0 2.165	1,5 3.310	5 RNAX1005...
HF85B-69.5/74.499-05-55	69,5 2.736	74,499 2.933	50,0 1.969	55,0 2.165	1,75 3.860	5 RNAX1005...
HF85B-74.5/79.499-05-55	74,5 2.933	79,499 3.130	50,0 1.969	55,0 2.165	2,0 4.410	5 RNAX1005...
HF85B-79.5/84.499-05-55	79,5 3.130	84,499 3.327	50,0 1.969	55,0 2.165	2,2 4.850	5 RNAX1005...

Części zamienne, zawarte w dostawie

Do głowicy	Śruba regulacyjna	Wkładka	Śruba mocująca	Śruba do płytki	Klucz (Typu flaga)	Klucz ustawczy	Docisk mocujący
HF85B 05-55	SH4075S	CARTCYHF20B	LDH4012	C03010-T09P	H2.0-2D	2SMS795	B6027

Akcesoria

Do głowicy	Klucz dynamometryczny	Klucz Torx do śruby mocującej płytkę / wkładkę
HF85B 05-55	H00-2020	T00-09P20

Uwaga

Klucz dynamometryczny H00-2020 dla śruby mocującej

Klucz dynamometryczny T00-09P20 dla śruby mocującej

Wielk. mom. T00-09P20: 2 Nm.

Wielk. mom. H00-2020: 2 Nm.

HF86



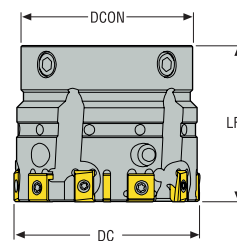
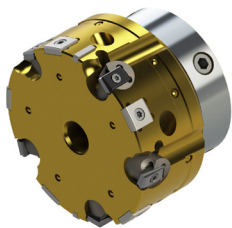





Głowice do płytek LNEG, otwór przelotowy \varnothing 59,5-84,499 mm / 2.343-3.327"





- Płytki, gatunki i geometry patrz str. 429-431
- Parametry skrawania, patrz strona (strony) 456-463

Oznaczenie	DCN	DCX	LFS	DCON	Waga	Płytki
	mm Cal.	mm Cal.	mm Cal.	mm Cal.	kg lbs	
HF86-59.5-64.499-05-55	59,5 2.343	64,499 2.539	50,0 1.969	55,0 2.165	1,3 2.870	5 LNEG1003...
HF86-64.5-69.499-05-55	64,5 2.539	69,499 2.736	50,0 1.969	55,0 2.165	1,5 3.310	5 LNEG1003...
HF86-69.5-74.499-05-55	69,5 2.736	74,499 2.933	50,0 1.969	55,0 2.165	1,75 3.860	5 LNEG1003...
HF86-74.5-79.499-05-55	74,5 2.933	79,499 3.130	50,0 1.969	55,0 2.165	2,0 4.410	5 LNEG1003...
HF86-79.5-84.499-05-55	79,5 3.130	84,499 3.327	50,0 1.969	55,0 2.165	2,2 4.850	5 LNEG1003...

Części zamienne, zawarte w dostawie

Do głowicy	Śruba regulacyjna	Wkładka	Śruba mocująca	Śruba do płytki	Klucz (Typu flaga)	Klucz ustawczy	Docisk mocujący
							
HF86 05-55	SH4075S	CARTCYLN20	LDH4010	C02506-T07P	H2.0-2D	2SMS795	B6027

Akcesoria

Do głowicy	Klucz dynamometryczny	Klucz Torx do śruby mocującej płytkę / wkładkę
		
HF86 05-55	H00-2020	T00-07P09

Uwaga

Klucz dynamometryczny H00-2020 dla śruby mocującej

Klucz dynamometryczny T00-07P09 dla śruby mocującej

Wielk. mom. T00-07P09: 0,9 Nm.

Wielk. mom. H00-2020: 2 Nm.

HF86B

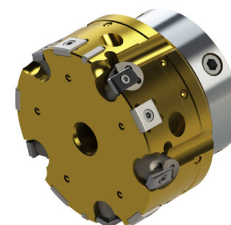
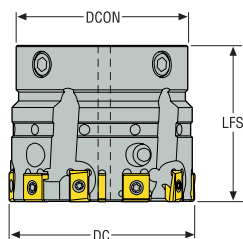
Głowice do płytek LNEG, otwór nieprzelotowy \varnothing 59,5-84,499 mm / 2.343-3.327"

- Płytki, gatunki i geometry patrz str. 429-431
- Parametry skrawania, patrz strona (strony) 456-463

Oznaczenie	DCN	DCX	LFS	DCON	Waga	Płytki
	mm Cal.	mm Cal.	mm Cal.	mm Cal.	kg lbs	
HF86B-59.5/64.499-05-55	59,5 2.343	64,499 2.539	50,0 1.969	55,0 2.165	1,3 2.870	5
HF86B-64.5/69.499-05-55	64,5 2.539	69,499 2.736	50,0 1.969	55,0 2.165	1,5 3.310	5
HF86B-69.5/74.499-05-55	69,5 2.736	74,499 2.933	50,0 1.969	55,0 2.165	1,75 3.860	5
HF86B-74.5/79.499-05-55	74,5 2.933	79,499 3.130	50,0 1.969	55,0 2.165	2,0 4.410	5
HF86B-79.5/84.499-05-55	79,5 3.130	84,499 3.327	50,0 1.969	55,0 2.165	2,2 4.850	5

Części zamienne, zawarte w dostawie

Do głowicy	Śruba regulacyjna	Wkładka	Śruba mocująca	Śruba do płytki	Klucz (Typu flaga)	Klucz ustawczy	Docisk mocujący
HF86B 05-55	SH4075S	CARTCYLN20B	LDH4010	C02506-T07P	H2.0-2D	2SMS795	B6027

Akcesoria

Do głowicy	Klucz dynamometryczny	Klucz Torx do śruby mocującej płytkę / wkładkę
HF86B 05-55	H00-2020	T00-07P09

Uwaga

Klucz dynamometryczny H00-2020 dla śruby mocującej

Klucz dynamometryczny T00-07P09 dla śruby mocującej

Wielk. mom. T00-07P09: 0,9 Nm.

Wielk. mom. H00-2020: 2 Nm.

HF55

Oprawki Seco-Capto™ do \varnothing 59,5-84,499 mm

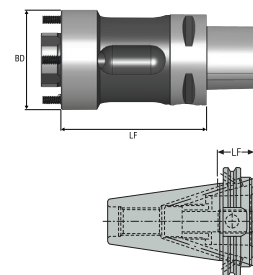
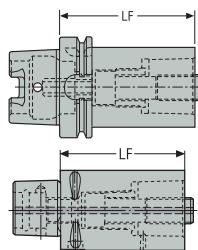

Oznaczenie Oprawka rozwiertaka	Numer produktu	LF min	LF max	Stożek	BD	Waga
		mm	mm		mm	kg
HF55-080-C5	02688647	-	80	C5	55	1,5
HF55...HSKA63	-	80	239	HSK-A63	55	0,0
HF55...HSKA80	-	100	239	HSK-A80	55	0,0
HF55...HSKA100	-	100	239	HSK-A100	55	0,0
HF55...DIN40ADB	-	80	239	DIN40ADB	55	0,0
HF55...DIN50ADB	-	80	304	DIN50ADB	55	0,0
HF55...BT40ADB	-	80	239	BT40ADB	55	0,0
HF55...BT50ADB	-	80	304	BT50ADB	55	0,0

Oprawki i przedłużenia dla HF55-080-C5 (więcej informacji w katalogu Seco Systemy Narzędziowe).

Oznaczenie Chwył	Numer produktu	LF	Stożek	Wielkość Seco-Capto	Waga
		mm			kg
HA10-C4-040-090	10197963	90	HSK-A100	C4	2,6
HA06-C5-050-090	10197966	90	HSK-A63	C5	3,1
C5-390B.140-40040	02924112	40	DIN40	C5	0,9
C5-390B.140-40080	02924113	80	DIN40	C5	1,5
C5-390B.55-40050	02925967	50	BT40	C5	1,1
C5-390B.55-40090	02925968	90	BT40	C5	1,7
C5-390B.140-50030	02924114	30	DIN50	C5	2,6
C5-390B.140-50070	02924115	70	DIN50	C5	3,1
C5-390B.58-50040	02925969	40	BT50	C5	3,4
C5-390B.58-50080	02925970	80	BT50	C5	4,0

Oznaczenie Przedłużka	Numer produktu	LF	Stożek	Wielkość Seco-Capto	Waga
		mm			kg
C5-391.01-50080A	75039886	-	C5	C5	1,12
C5-391.01-50100A	00004773	-	C5	C5	1,39
C6-391.02-50080A	75039894	-	C6	C5	1,45
C6-391.02-50110A	02207400	-	C6	C5	2,15
C8-391.02-50080B	03080011	-	C8	C5	2,4

HF55

Graflex® oprawka dla \varnothing 59,5-84,499 mm

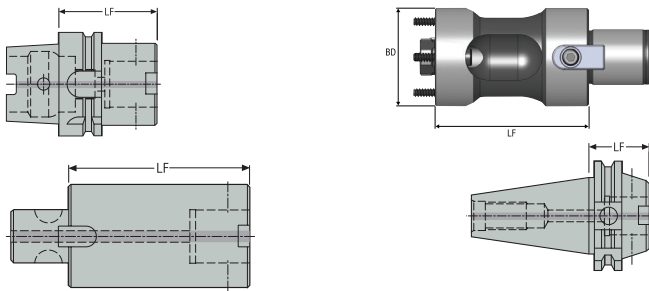

Oznaczenie Oprawka rozwiertaka	Numer produktu	LF min	LF max	Stożek	BD	Waga
		mm	mm		mm	kg
HF55-080-G5	02698871	-	80	G5	55	1,3
HF55...HKA63	-	80	239	HSK-A63	55	0,0
HF55...HKA80	-	100	239	HSK-A80	55	0,0
HF55...HKA100	-	100	239	HSK-A100	55	0,0
HF55...DIN40ADB	-	80	239	DIN40ADB	55	0,0
HF55...DIN50ADB	-	80	304	DIN50ADB	55	0,0
HF55...BT40ADB	-	80	239	BT40ADB	55	0,0
HF55...BT50ADB	-	80	304	BT50ADB	55	0,0

Oprawki i przedłużenia dla HF55-080-G5 (więcej informacji w katalogu Seco Systemy Narzędziowe).

Oznaczenie Chwyt	Numer produktu	LF	Stożek	Wielk. Graflex	Waga
		mm			kg
EM93044012860	00086920	60	HSK-A63	G5	0,98
EM930440128100	00086921	100	HSK-A63	G5	1,58
EM930440128140	00086922	140	HSK-A63	G5	2,18
EM93064012865	00086927	65	HSK-A100	G5	2,37
EM930640128110	00086928	110	HSK-A100	G5	3,02
EM930640128150	00086929	150	HSK-A100	G5	3,7
EM34694012840	02458421	40	DIN40	G5	0,93
EM34694012880	02503301	80	DIN40	G5	1,5
EM346940128120	02503302	120	DIN40	G5	2,08
EM34144012845	02457989	45	BT40	G5	1,12
EM34144012880	02503371	80	BT40	G5	1,54
EM341440128120	02503372	120	BT40	G5	2,12
EM34714012840	02503312	40	DIN50	G5	2,75
EM341640128100	02503381	100	BT50	G5	4,22
EM34164012855	02503380	55	BT50	G5	4,0
EM341640128140	02503382	140	BT50	G5	4,8

Oznaczenie Przedłużka	Numer produktu	LF	Stożek	Wielk. Graflex	Waga
		mm			kg
M402550	00056762	-	G5	G5	0,72
M402551	00056763	-	G5	G5	1,12
M402552	00056764	-	G5	G5	1,48

HF85

Głowice do płytek RNAX, otwór przelotowy \varnothing 84,5-119,499 mm / 3.327-4.705"

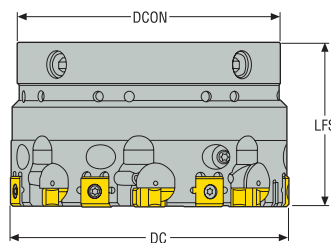
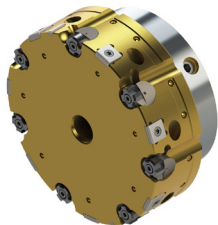

- Płytki, gatunki i geometry patrz str. 429-431
- Parametry skrawania, patrz strona (strony) 456-463

Oznaczenie	DCN	DCX	LFS	DCON	Waga	Płytki
	mm Cal.	mm Cal.	mm Cal.	mm Cal.	kg lbs	
HF85-84.5/89.499-07-80	84,5 3.327	89,499 3.524	50,0 1.969	80,0 3.150	1,68 3.700	7 RNAX1005...
HF85-89.5/94.499-07-80	89,5 3.524	94,499 3.720	50,0 1.969	80,0 3.150	1,85 4.080	7 RNAX1005...
HF85-94.5/99.499-07-80	94,5 3.720	99,499 3.917	50,0 1.969	80,0 3.150	2,02 4.450	7 RNAX1005...
HF85-99.5/104.499-07-80	99,5 3.917	104,499 4.114	50,0 1.969	80,0 3.150	2,2 4.850	7 RNAX1005...
HF85-104.5/109.499-07-80	104,5 4.114	109,499 4.311	50,0 1.969	80,0 3.150	2,4 5.290	7 RNAX1005...
HF85-109.5/114.499-07-80	109,5 4.311	114,499 4.508	50,0 1.969	80,0 3.150	2,61 5.750	7 RNAX1005...
HF85-114.5/119.499-07-80	114,5 4.508	119,499 4.705	50,0 1.969	80,0 3.150	2,82 6.220	7 RNAX1005...

Części zamienne, zawarte w dostawie

Do głowicy	Śruba regulacyjna	Wkładka	Śruba mocująca	Śruba do płytki	Klucz (Typu flaga)	Klucz ustawczy	Docisk mocujący
HF85 07-80	SH4075S	CARTCYHF20	LDH4012	C03010-T09P	H2.0-2D	4SMS795	B6027

Akcesoria

Do głowicy	Klucz dynamometryczny	Klucz Torx do śruby mocującej płytkę / wkładkę
HF85 07-80	H00-2020	T00-09P20

Uwaga

Klucz dynamometryczny H00-2020 dla śruby mocującej

Klucz dynamometryczny T00-09P20 dla śruby mocującej

Wielk. mom. T00-09P20: 2 Nm.

Wielk. mom. H00-2020: 2 Nm.

HF85B

Głowice do płyt RNAX, otwór nieprzelotowy \varnothing 84,5-119,499 mm / 3.327-4.705"

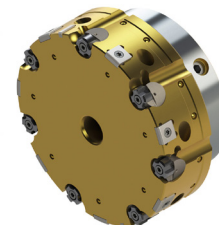
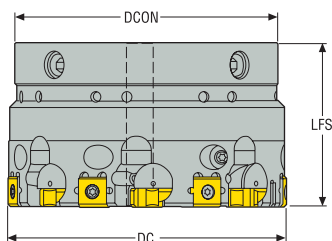

- Płytki, gatunki i geometry patrz str. 429-431
- Parametry skrawania, patrz strona (strony) 456-463

Oznaczenie	DCN	DCX	LFS	DCON	Waga	Płytki
	mm Cal.	mm Cal.	mm Cal.	mm Cal.	kg lbs	
HF85B-84.5/89.499-07-80	84,5 3.327	89,499 3.524	50,0 1.969	80,0 3.150	1,68 3.700	7
HF85B-89.5/94.499-07-80	89,5 3.524	94,499 3.720	50,0 1.969	80,0 3.150	1,85 4.080	7
HF85B-94.5/99.499-07-80	94,5 3.720	99,499 3.917	50,0 1.969	80,0 3.150	2,02 4.450	7
HF85B-99.5/104.499-07-80	99,5 3.917	104,499 4.114	50,0 1.969	80,0 3.150	2,2 4.850	7
HF85B-104.5/109.499-07-80	104,5 4.114	109,499 4.311	50,0 1.969	80,0 3.150	2,4 5.290	7
HF85B-109.5/114.499-07-80	109,5 4.311	114,499 4.508	50,0 1.969	80,0 3.150	2,61 5.750	7
HF85B-114.5/119.499-07-80	114,5 4.508	119,499 4.705	50,0 1.969	80,0 3.150	2,82 6.220	7

Części zamienne, zawarte w dostawie

Do głowicy	Śruba regulacyjna	Wkładka	Śruba mocująca	Śruba do płytki	Klucz (Typu flaga)	Klucz ustawczy	Docisk mocujący
HF85B 07-80	SH4075S	CARTCYHF20B	LDH4010	C03010-T09P	H2.0-2D	2SMS795	B6027

Akcesoria

Do głowicy	Klucz dynamometryczny	Klucz Torx do śruby mocującej płytkę / wkładkę
HF85B 07-80	H00-2020	T00-09P20

Uwaga

Klucz dynamometryczny H00-2020 dla śruby mocującej

Klucz dynamometryczny T00-09P20 dla śruby mocującej

Wielk. mom. T00-09P20: 2 Nm.

Wielk. mom. H00-2020: 2 Nm.

HF86

Głowice do płytek LNEG, otwór przelotowy \varnothing 84,5-119,499 mm / 3.327-4.705"

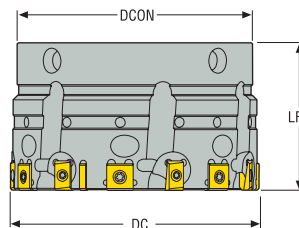
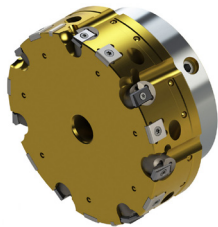

- Płytki, gatunki i geometry patrz str. 429-431
- Parametry skrawania, patrz strona (strony) 456-463

Oznaczenie	DCN	DCX	LFS	DCON	Waga	Płytki
	mm Cal.	mm Cal.	mm Cal.	mm Cal.	kg lbs	
HF86-84.5/89.499-07-80	84,5 3.327	89,499 3.524	50,0 1.969	80,0 3.150	1,68 3.700	7
HF86-89.5/94.499-07-80	89,5 3.524	94,499 3.720	50,0 1.969	80,0 3.150	1,85 4.080	7
HF86-94.5/99.499-07-80	94,5 3.720	99,499 3.917	50,0 1.969	80,0 3.150	2,02 4.450	7
HF86-99.5/104.499-07-80	99,5 3.917	104,499 4.114	50,0 1.969	80,0 3.150	2,2 4.850	7
HF86-104.5/109.499-07-80	104,5 4.114	109,499 4.311	50,0 1.969	80,0 3.150	2,4 5.290	7
HF86-109.5/114.499-07-80	109,5 4.311	114,499 4.508	50,0 1.969	80,0 3.150	2,61 5.750	7
HF86-114.5/119.499-07-80	114,5 4.508	119,499 4.705	50,0 1.969	80,0 3.150	2,82 6.220	7

Części zamienne, zawarte w dostawie

Do głowicy	Śruba regulacyjna	Wkładka	Śruba mocująca	Śruba do płytki	Klucz (Typu flaga)	Klucz ustawczy	Docisk mocujący
HF86 07-80	SH4075S	CARTCYLN20	LDH4010	C02506-T07P	H2.0-2D	2SMS795	B6027

Akcesoria

Do głowicy	Klucz dynamometryczny	Klucz Torx do śruby mocującej płytkę / wkładkę
HF86 07-80	H00-2020	T00-07P09

Uwaga

Klucz dynamometryczny H00-2020 dla śruby mocującej

Klucz dynamometryczny T00-07P09 dla śruby mocującej

Wielk. mom. T00-07P09: 0,9 Nm.

Wielk. mom. H00-2020: 2 Nm.

HF86B

Głowice do płytek LNEG, otwór nieprzelotowy \varnothing 84,5-119,499 mm / 3.327-4.705"

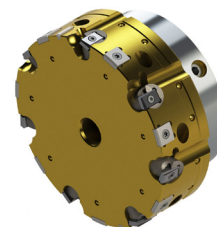
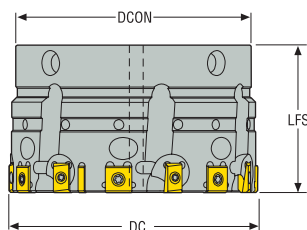

- Płytki, gatunki i geometry patrz str. 429-431
- Parametry skrawania, patrz strona (strony) 456-463

Oznaczenie	DCN	DCX	LFS	DCON	Waga	Płytki
	mm Cal.	mm Cal.	mm Cal.	mm Cal.	kg lbs	
HF86B-84.5/89.499-07-80	84,5 3.327	89,499 3.524	50,0 1.969	80,0 3.150	1,68 3.700	7
HF86B-89.5/94.499-07-80	89,5 3.524	94,499 3.720	50,0 1.969	80,0 3.150	1,85 4.080	7
HF86B-94.5/99.499-07-80	94,5 3.720	99,499 3.917	50,0 1.969	80,0 3.150	2,02 4.450	7
HF86B-99.5/104.499-07-80	99,5 3.917	104,499 4.114	50,0 1.969	80,0 3.150	2,2 4.850	7
HF86B-104.5/109.499-07-80	104,5 4.114	109,499 4.311	50,0 1.969	80,0 3.150	2,4 5.290	7
HF86B-109.5/114.499-07-80	109,5 4.311	114,499 4.508	50,0 1.969	80,0 3.150	2,61 5.750	7
HF86B-114.5/119.499-07-80	114,5 4.508	119,499 4.705	50,0 1.969	80,0 3.150	2,82 6.220	7

Części zamienne, zawarte w dostawie

Do głowicy	Śruba regulacyjna	Wkładka	Śruba mocująca	Śruba do płytki	Klucz (Typu flaga)	Klucz ustawczy	Docisk mocujący
HF86B	SH4075S	CARTCYLN20B	LDH4010	C02506-T07P	H2.0-2D	2SMS795	B6027

Akcesoria

Do głowicy	Klucz dynamometryczny	Klucz Torx do śruby mocującej płytkę / wkładkę
HF86B	H00-2020	T00-07P09

Uwaga

Klucz dynamometryczny H00-2020 dla śruby mocującej

Klucz dynamometryczny T00-07P09 dla śruby mocującej

Wielk. mom. T00-07P09: 0,9 Nm.

Wielk. mom. H00-2020: 2 Nm.

HF80

Oprawki Seco-Capto™ do Ø 84,5-119,499 mm

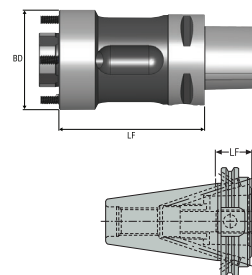
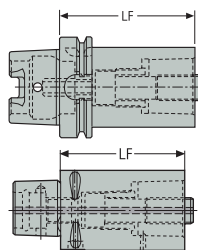

Oznaczenie Oprawka rozwiertaka	Numer produktu	LF min	LF max	Stożek	BD	Waga
		mm	mm		mm	kg
HF80-080-C6	02688648	-	80	C6	80	2,5
HF80...HSKA80	-	100	239	HSK-A80	80	0,0
HF80...HSKA100	-	100	239	HSK-A100	80	0,0
HF80...DIN50ADB	-	80	304	DIN50ADB	80	0,0
HF80...BT50ADB	-	80	304	BT50ADB	80	0,0

Oprawki i przedłużenia dla HF80-080-C6 (więcej informacji w katalogu Seco Systemy Narzędziowe).

Oznaczenie Chwył	Numer produktu	LF	Stożek	Wielkość Seco-Capto	Waga
		mm			kg
HA10-C6-063-110	10197967	110	HSK-A100	C6	3,8
C6-390B.140-40085	02924116	85	DIN40	C6	1,8
C6-390B.140-50030	02924117	30	DIN50	C6	2,5
C6-390B.140-50080	02924118	80	DIN50	C6	3,6
C6-390B.55-40075	02925971	75	BT40	C6	1,7
C6-390B.58-50100	02925973	100	BT50	C6	4,6
C6-390B.58-50050	02925972	50	BT50	C6	3,5

Oznaczenie Przedłużka	Numer produktu	LF	Stożek	Wielkość Seco-Capto	Waga
		mm			kg
C6-391.01-63100A	75039887	-	C6	C6	2,2
C6-391.01-63140A	00004840	-	C6	C6	3,1
C6-391.01-63060	02300834	-	C6	C6	1,31

Wstęp

Wiercenie

Rozwiercanie

Wytaczanie

Załącznik

HF80

Graflex® oprawka dla Ø 84,5-119,499 mm

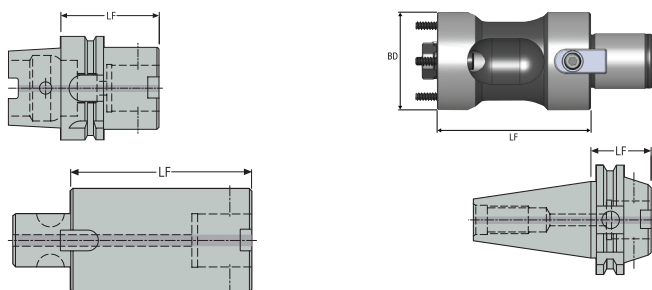

Oznaczenie Oprawka rozwiertaka	Numer produktu	LF min	LF max	Stożek	BD	Waga
		mm	mm		mm	kg
HF80-080-G6	02698873	-	80	G6	80	3,0
HF80...HSKA80	-	100	239	HSK-A80	80	0,0
HF80...HSKA100	-	100	239	HSK-A100	80	0,0
HF80...DIN50ADB	-	80	304	DIN50ADB	80	0,0
HF80...BT50ADB	-	80	304	BT50ADB	80	0,0

Oprawki i przedłużenia dla HF80-080-G6 (więcej informacji w katalogu Seco Systemy Narzędziowe).

Oznaczenie Chwył	Numer produktu	LF	Stożek	Wielk. Graflex	Waga
		mm			kg
EM93044013670	00086923	70	HSK-A63	G6	1,21
EM930440136120	00086924	120	HSK-A63	G6	2,38
EM930640136120	00086931	120	HSK-A100	G6	3,82
EM930640136160	00086932	160	HSK-A100	G6	4,72
EM34694013660	02503303	60	DIN40	G6	1,24
EM346940136120	02503304	120	DIN40	G6	2,65
EM34144013650	02503373	50	BT40	G6	1,13
EM341440136120	02503374	120	BT40	G6	2,78
EM34714013645	02503317	45	DIN50	G6	2,88
EM347140136100	02503318	100	DIN50	G6	4,1
EM347140136140	02503319	140	DIN50	G6	4,99
EM34164013663	02503383	63	BT50	G6	4,2
EM341640136100	02503384	100	BT50	G6	4,6
EM341640136140	02503385	140	BT50	G6	5,54

Oprawki i przedłużenia dla HF32-050-G3 (więcej informacji w katalogu Seco Systemy Narzędziowe).

Oznaczenie Przedłużka	Numer produktu	LF	Stożek	Wielk. Graflex	Waga
		mm			kg
M402660	00056765	-	G6	G6	1,38
M402661	00056766	-	G6	G6	2,1
M402662	00056767	-	G6	G6	2,82

HF85

Głowice do płytek RNAX, otwór przelotowy \varnothing 119,5-154,499 mm / 4.705-6.083"

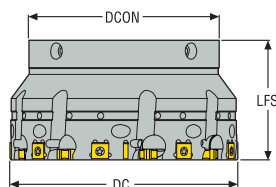
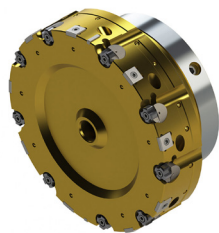

- Płytki, gatunki i geometry patrz str. 429-431
- Parametry skrawania, patrz strona (strony) 456-463

Oznaczenie	DCN	DCX	LFS	DCN	Waga	Płytki
	mm Cal.	mm Cal.	mm Cal.	mm Cal.	kg lbs	
HF85-119.5/124.499-09-100	119,5 4.705	124,499 4.902	63,0 2.480	100,0 3.937	3,89 8.580	9 RNAX1005...
HF85-124.5/129.499-09-100	124,5 4.902	129,499 5.098	63,0 2.480	100,0 3.937	4,15 9.150	9 RNAX1005...
HF85-129.5/134.499-09-100	129,5 5.098	134,499 5.295	63,0 2.480	100,0 3.937	4,42 9.740	9 RNAX1005...
HF85-134.5/139.499-09-100	134,5 5.295	139,499 5.492	63,0 2.480	100,0 3.937	4,7 10.360	9 RNAX1005...
HF85-139.5/144.499-09-100	139,5 5.492	144,499 5.689	63,0 2.480	100,0 3.937	4,99 11.000	9 RNAX1005...
HF85-144.5/149.499-09-100	144,5 5.689	149,499 5.886	63,0 2.480	100,0 3.937	5,29 11.660	9 RNAX1005...
HF85-149.5/154.499-09-100	149,5 5.886	154,499 6.083	63,0 2.480	100,0 3.937	5,6 12.350	9 RNAX1005...

Części zamienne, zawarte w dostawie

Do głowicy	Śruba regulacyjna	Wkładka	Śruba mocująca	Śruba do płytki	Klucz (Typu flaga)	Klucz ustawczy	Docisk mocujący
HF85 09-100	SH4075S	CARTCYHF20	LDH4012	C03010-T09P	H2.0-2D	4SMS795	B6027

Akcesoria

Do głowicy	Klucz dynamometryczny	Klucz Torx do śruby mocującej płytkę / wkładkę
HF85 09-100	H00-2020	T00-09P20

Uwaga

Klucz dynamometryczny H00-2020 dla śruby mocującej

Klucz dynamometryczny T00-09P20 dla śruby mocującej

Wielk. mom. T00-09P20: 2 Nm.

Wielk. mom. H00-2020: 2 Nm.

HF85B

Głowice do płytek RNAX, otwór nieprzelotowy \varnothing 119,5-154,499 mm / 4.705-6.083"

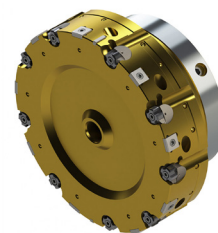
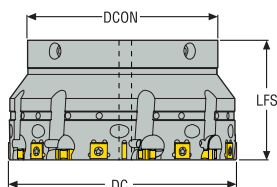

- Płytki, gatunki i geometry patrz str. 429-431
- Parametry skrawania, patrz strona (strony) 456-463

Oznaczenie	DCN	DCX	LFS	DCON	Waga	Płytki
	mm Cal.	mm Cal.	mm Cal.	mm Cal.	kg lbs	
HF85B-119.5/124.499-09-100	119,5 4.705	124,499 4.902	63,0 2.480	100,0 3.937	3,89 8.580	9
HF85B-124.5/129.499-09-100	124,5 4.902	129,499 5.098	63,0 2.480	100,0 3.937	4,15 9.150	9
HF85B-134.5/139.499-09-100	134,5 5.295	139,499 5.492	63,0 2.480	100,0 3.937	4,7 10.360	9
HF85B-139.5/144.499-09-100	139,5 5.492	144,499 5.689	63,0 2.480	100,0 3.937	4,99 11.000	9
HF85B-144.5/149.499-09-100	144,5 5.689	149,499 5.886	63,0 2.480	100,0 3.937	5,29 11.660	9
HF85B-149.5/154.499-09-100	149,5 5.886	154,499 6.083	63,0 2.480	100,0 3.937	5,6 12.350	9

Części zamienne, zawarte w dostawie

Do głowicy	Śruba regulacyjna	Wkładka	Śruba mocująca	Śruba do płytki	Klucz (Typu flaga)	Klucz ustawczy	Docisk mocujący
HF85B 09-100	SH4075S	CARTCYHF20B	LDH4012	C03010-T09P	H2.0-2D	2SMS795	B6027

Akcesoria

Do głowicy	Klucz dynamometryczny	Klucz Torx do śruby mocującej płytkę / wkładkę
HF85B 09-100	H00-2020	T00-09P20

Uwaga

Klucz dynamometryczny H00-2020 dla śruby mocującej

Klucz dynamometryczny T00-09P20 dla śruby mocującej

Wielk. mom. T00-09P20: 2 Nm.

Wielk. mom. H00-2020: 2 Nm.

HF86

Głowice do płytek LNEG, otwór przelotowy \varnothing 119,5-154,499 mm / 4.705-6.083"

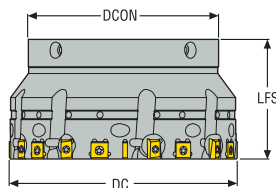
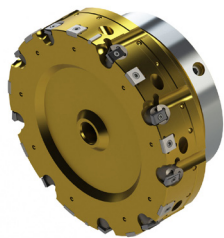

- Płytki, gatunki i geometry patrz str. 429-431
- Parametry skrawania, patrz strona (strony) 456-463

Oznaczenie	DCN	DCX	LFS	DCON	Waga	Płytki
	mm Cal.	mm Cal.	mm Cal.	mm Cal.	kg lbs	
HF86-119.5/124.499-09-100	119,5 4.705	124,499 4.902	63,0 2.480	100,0 3.937	3,89 8.580	9 LNEG1003...
HF86-124.5/129.499-09-100	124,5 4.902	129,499 5.098	63,0 2.480	100,0 3.937	4,15 9.150	9 LNEG1003...
HF86-129.5/134.499-09-100	129,5 5.098	134,499 5.295	63,0 2.480	100,0 3.937	4,42 9.740	9 LNEG1003...
HF86-134.5/139.499-09-100	134,5 5.295	139,499 5.492	63,0 2.480	100,0 3.937	4,7 10.360	9 LNEG1003...
HF86-139.5/144.499-09-100	139,5 5.492	144,499 5.689	63,0 2.480	100,0 3.937	4,99 11.000	9 LNEG1003...
HF86-144.5/149.499-09-100	144,5 5.689	149,499 5.886	63,0 2.480	100,0 3.937	5,29 11.660	9 LNEG1003...
HF86-149.5/154.499-09-100	149,5 5.886	154,499 6.083	63,0 2.480	100,0 3.937	5,6 12.350	9 LNEG1003...

Części zamienne, zawarte w dostawie

Do głowicy	Śruba regulacyjna	Wkładka	Śruba mocująca	Śruba do płytki	Klucz (Typu flaga)	Klucz ustawczy	Docisk mocujący
HF86 09-100	SH4075S	CARTCYHF20	LDH4010	C02506-T07P	H2.0-2D	2SMS795	B6027

Akcesoria

Do głowicy	Klucz dynamometryczny	Klucz Torx do śruby mocującej płytkę / wkładkę
HF86 09-100	H00-2020	T00-07P09

Uwaga

Klucz dynamometryczny H00-2020 dla śruby mocującej

Klucz dynamometryczny T00-07P09 dla śruby mocującej

Wielk. mom.
T00-07P09: 0,9 Nm.
Wielk. mom. H00-2020: 2 Nm.

HF86B

Głowice do płytek LNEG, otwór nieprzelotowy \varnothing 119,5-154,499 mm / 4.705-6.083"

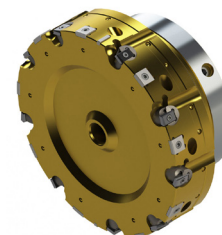
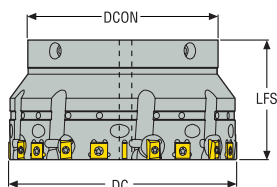

- Płytki, gatunki i geometry patrz str. 429-431
- Parametry skrawania, patrz strona (strony) 456-463

Oznaczenie	DCN	DCX	LFS	DCON	Waga	Płytki
	mm Cal.	mm Cal.	mm Cal.	mm Cal.	kg lbs	
HF86B-119.5/124.499-09-100	119,5 4.705	124,499 4.902	63,0 2.480	100,0 3.937	3,89 8.580	9 LNEG1003...
HF86B-124.5/129.499-09-100	124,5 4.902	129,499 5.098	63,0 2.480	100,0 3.937	4,15 9.150	9 LNEG1003...
HF86B-129.5/134.499-09-100	129,5 5.098	134,499 5.295	63,0 2.480	100,0 3.937	4,42 9.740	9 LNEG1003...
HF86B-134.5/139.499-09-100	134,5 5.295	139,499 5.492	63,0 2.480	100,0 3.937	4,7 10.360	9 LNEG1003...
HF86B-139.5/144.499-09-100	139,5 5.492	144,499 5.689	63,0 2.480	100,0 3.937	4,99 11.000	9 LNEG1003...
HF86B-144.5/149.499-09-100	144,5 5.689	149,499 5.886	63,0 2.480	100,0 3.937	5,29 11.660	9 LNEG1003...
HF86B-149.5/154.499-09-100	149,5 5.886	154,499 6.083	63,0 2.480	100,0 3.937	5,6 12.350	9 LNEG1003...

Części zamienne, zawarte w dostawie

Do głowicy	Śruba regulacyjna	Wkładka	Śruba mocująca	Śruba do płytki	Klucz (Typu flaga)	Klucz ustawczy	Docisk mocujący
HF86B 09-100	SH4075S	CARTCYLN20B	LDH4010	C02506-T07P	H2.0-2D	2SMS795	B6027

Akcesoria

Do głowicy	Klucz dynamometryczny	Klucz Torx do śruby mocującej płytkę / wkładkę
HF86B 09-100	H00-2020	T00-07P09

Uwaga

Klucz dynamometryczny H00-2020 dla śruby mocującej

Klucz dynamometryczny T00-07P09 dla śruby mocującej

Wielk. mom. T00-07P09: 0,9 Nm.
Wielk. mom. H00-2020: 2 Nm.

HF100

Oprawki Seco-Capto™ do Ø 119,5-154,499 mm

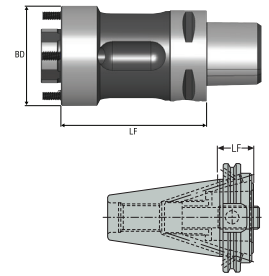
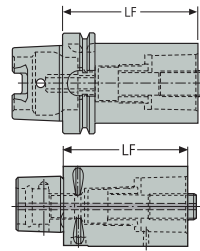

Oznaczenie Oprawka rozwiertaka	Numer produktu	LF min	LF max	Stożek	BD	Waga
		mm	mm		mm	kg
HF100-100-C8	02688649	-	100	C8	100	4,9
HF100...HSKA80	-	100	238	HSK-A80	100	0,0
HF100...HSKA100	-	100	238	HSK-A100	100	0,0
HF100...DIN50ADB	-	100	238	DIN50ADB	100	0,0
HF100...BT50ADB	-	100	238	BT50ADB	100	0,0

Oprawki i przedłużenia dla HF100-100-C8 (więcej informacji w katalogu Seco Systemy Narzędziowe).

Oznaczenie Chwyt	Numer produktu	LF	Stożek	Wielkość Seco-Capto	Waga
		mm			kg
HA10-C8-080-120	10197968	120	HSK-A100	C8	4,1
C8-390B.140-50070	02924119	70	DIN50	C8	3,7
C8-390B.140-50120	02924120	120	DIN50	C8	5,6
C8-390B.58-50070	02925974	70	BT50	C8	4,0
C8-390B.58-50120	02925975	120	BT50	C8	5,9

Oznaczenie Przedłużka	Numer produktu	LF	Stożek	Wielkość Seco-Capto	Waga
		mm			kg
C8-391.01-80100A	75039888	-	C8	C8	3,62
C8-391.01-80125A	00004841	-	C8	C8	4,54

HF100

Graflex® oprawka dla \varnothing 119,5-154,499 mm

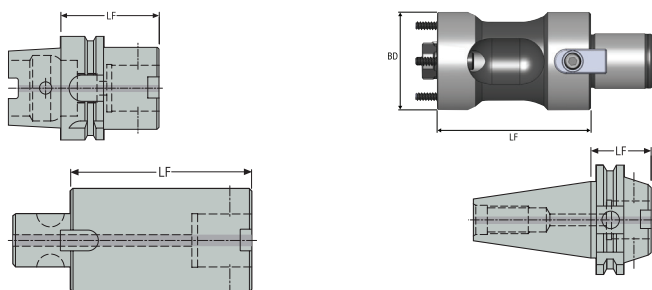

Oznaczenie Oprawka rozwiertaka	Numer produktu	LF min	LF max	Stożek	BD	Waga
		mm	mm		mm	kg
HF100-100-G7	02698874	-	100	G7	100	5,2
HF100...HSKA80	-	100	238	HSK-A80	100	0,0
HF100...HSKA100	-	100	238	HSK-A100	100	0,0
HF100...DIN50ADB	-	100	238	DIN50ADB	100	0,0
HF100...BT50ADB	-	100	238	BT50ADB	100	0,0

Oprawki i przedłużenia dla HF100-100-G7 (więcej informacji w katalogu Seco Systemy Narzędziowe).

Oznaczenie Chwył	Numer produktu	LF	Stożek	Wielk. Graflex	Waga
		mm			kg
EM93064014685	00074385	85	HSK-A100	G7	3,99
EM930640146160	00086933	160	HSK-A100	G7	7,67
EM34714014650	02503320	50	DIN50	G7	3,23
EM347140146120	02503321	120	DIN50	G7	6,48
EM347140146200	02503324	200	DIN50	G7	10,4
EM34164014665	02503386	65	BT50	G7	4,4
EM341640146120	02503387	120	BT50	G7	6,8
EM341640146200	02503388	200	BT50	G7	10,7

Oznaczenie Przedłużka	Numer produktu	LF	Stożek	Wielk. Graflex	Waga
		mm			kg
M402770	00056768	-	G7	G7	2,9
M402771	00056769	-	G7	G7	4,03
M402772	00056770	-	G7	G7	5,8

Wstęp

Wiercenie

Rozwiercanie

Wytaczanie

Załącznik

Parametry skrawania – LNEG...-EB45 Metryczne

SMG		$a_p (\varnothing)$	f				v_c		
			z=3	z=5	z=7	z=9	RX2000	CF	RX1500
P1	LNEG1003-EB45	0,15-0,25	0,15-0,45	0,25-0,75	0,25-1,05	0,45-1,35	120 (80-200)	180 (120-250)	220 (120-300)
P2	LNEG1003-EB45	0,15-0,25	0,15-0,45	0,25-0,75	0,25-1,05	0,45-1,35	120 (80-200)	180 (120-250)	220 (120-300)
P3	LNEG1003-EB45	0,15-0,25	0,15-0,45	0,25-0,75	0,25-1,05	0,45-1,35	120 (80-200)	180 (120-250)	220 (120-300)
P4	LNEG1003-EB45	0,15-0,25	0,15-0,45	0,25-0,75	0,25-1,05	0,45-1,35	60 (40-120)	80 (60-150)	100 (80-200)
P5	LNEG1003-EB45	0,15-0,25	0,15-0,45	0,25-0,75	0,25-1,05	0,45-1,35	60 (40-120)	80 (60-150)	100 (80-200)
P6	LNEG1003-EB45	0,15-0,25	0,15-0,45	0,25-0,75	0,25-1,05	0,45-1,35	60 (40-120)	80 (60-150)	100 (80-200)
P7	LNEG1003-EB45	0,15-0,25	0,15-0,45	0,25-0,75	0,25-1,05	0,45-1,35	60 (40-120)	80 (60-150)	100 (80-200)
P8	LNEG1003-EB45	0,15-0,25	0,15-0,45	0,25-0,75	0,25-1,05	0,45-1,35	40 (30-70)	60 (50-100)	80 (60-120)
P11	LNEG1003-EB45	0,15-0,25	0,15-0,45	0,25-0,75	0,25-1,05	0,45-1,35	40 (30-70)	60 (50-100)	80 (60-120)
P12	LNEG1003-EB45	0,15-0,25	0,15-0,45	0,25-0,75	0,25-1,05	0,45-1,35	30 (25-55)	45 (40-80)	65 (45-95)
M1	LNEG1003-EB45	0,10-0,20	0,15-0,30	0,25-0,50	0,35-0,70	0,45-0,90	35 (25-60)	-	-
M2	LNEG1003-EB45	0,10-0,20	0,15-0,30	0,25-0,50	0,35-0,70	0,45-0,90	35 (25-60)	-	-
M3	LNEG1003-EB45	0,10-0,20	0,15-0,30	0,25-0,50	0,35-0,70	0,45-0,90	35 (25-60)	-	-
M4	LNEG1003-EB45	0,10-0,20	0,15-0,30	0,25-0,50	0,35-0,70	0,45-0,90	25 (20-50)	-	-
M5	LNEG1003-EB45	0,10-0,20	0,15-0,30	0,25-0,50	0,35-0,70	0,45-0,90	25 (20-50)	-	-
K1	LNEG1003-EB45	0,20-0,50	0,15-0,45	0,25-0,75	0,25-1,05	0,45-1,35	100 (60-200)	-	220 (150-300)
K2	LNEG1003-EB45	0,20-0,50	0,15-0,45	0,25-0,75	0,25-1,05	0,45-1,35	50 (35-80)	-	70 (50-120)
K3	LNEG1003-EB45	0,20-0,50	0,15-0,45	0,25-0,75	0,25-1,05	0,45-1,35	100 (60-200)	-	220 (150-300)
K4	LNEG1003-EB45	0,20-0,50	0,15-0,45	0,25-0,75	0,25-1,05	0,45-1,35	70 (50-120)	100 (60-120)	150 (110-200)
K5	LNEG1003-EB45	0,20-0,50	0,15-0,45	0,25-0,75	0,25-1,05	0,45-1,35	70 (50-120)	100 (60-120)	150 (110-200)
K6	LNEG1003-EB45	0,20-0,50	0,15-0,45	0,25-0,75	0,25-1,05	0,45-1,35	100 (60-200)	-	220 (150-300)
K7	LNEG1003-EB45	0,20-0,50	0,15-0,45	0,25-0,75	0,25-1,05	0,45-1,35	100 (60-200)	-	220 (150-300)
H3	LNEG1003-EB45	0,10-0,20	0,1-0,25	0,15-0,40	0,25-0,5	0,30-0,7	20 (10-30)	-	-
H5	LNEG1003-EB45	0,10-0,20	0,1-0,25	0,15-0,40	0,25-0,5	0,30-0,7	20 (10-30)	-	-
H7	LNEG1003-EB45	0,10-0,20	0,1-0,25	0,15-0,40	0,25-0,5	0,30-0,7	20 (10-30)	-	-
H8	LNEG1003-EB45	0,10-0,20	0,1-0,25	0,15-0,40	0,25-0,5	0,30-0,7	20 (10-30)	-	-
H11	LNEG1003-EB45	0,10-0,20	0,1-0,25	0,15-0,40	0,25-0,5	0,30-0,7	20 (10-30)	-	-
H12	LNEG1003-EB45	0,10-0,20	0,1-0,25	0,15-0,40	0,25-0,5	0,30-0,7	20 (10-30)	-	-
H21	LNEG1003-EB45	0,10-0,20	0,1-0,25	0,15-0,40	0,25-0,5	0,30-0,7	20 (10-30)	-	-
H31	LNEG1003-EB45	0,10-0,20	0,1-0,25	0,15-0,40	0,25-0,5	0,30-0,7	20 (10-30)	-	-

SMG = Grupy materiałowe Seco

a_p = mm

f = mm/obr

v_c = m/min

Wszystkie parametry są wartościami początkowymi

Wstęp

Wiercenie

Rozwiercanie

Wyłaczanie

Załącznik

Parametry skrawania – LNEG...-EB45 *cał*

SMG		a_p (∅)	f				v_c		
			z=3	z=5	z=7	z=9	RX2000	CF	RX1500
P1	LNEG1003-EB45	0.006–0.010	0.006–0.018	0.010–0.030	0.010–0.041	0.018–0.053	395 (260-655)	590 (395-820)	720 (395-985)
P2	LNEG1003-EB45	0.006–0.010	0.006–0.018	0.010–0.030	0.010–0.041	0.018–0.053	395 (260-655)	590 (395-820)	720 (395-985)
P3	LNEG1003-EB45	0.006–0.010	0.006–0.018	0.010–0.030	0.010–0.041	0.018–0.053	395 (260-655)	590 (395-820)	720 (395-985)
P4	LNEG1003-EB45	0.006–0.010	0.006–0.018	0.010–0.030	0.010–0.041	0.018–0.053	195 (130-395)	260 (195-490)	330 (260-655)
P5	LNEG1003-EB45	0.006–0.010	0.006–0.018	0.010–0.030	0.010–0.041	0.018–0.053	195 (130-395)	260 (195-490)	330 (260-655)
P6	LNEG1003-EB45	0.006–0.010	0.006–0.018	0.010–0.030	0.010–0.041	0.018–0.053	195 (130-395)	260 (195-490)	330 (260-655)
P7	LNEG1003-EB45	0.006–0.010	0.006–0.018	0.010–0.030	0.010–0.041	0.018–0.053	195 (130-395)	260 (195-490)	330 (260-655)
P8	LNEG1003-EB45	0.006–0.010	0.006–0.018	0.010–0.030	0.010–0.041	0.018–0.053	130 (100-230)	195 (165-330)	260 (195-395)
P11	LNEG1003-EB45	0.006–0.010	0.006–0.018	0.010–0.030	0.010–0.041	0.018–0.053	130 (100-230)	195 (165-330)	260 (195-395)
P12	LNEG1003-EB45	0.006–0.010	0.006–0.018	0.010–0.030	0.010–0.041	0.010–0.053	100 (85-185)	150 (135-265)	215 (150-315)
M1	LNEG1003-EB45	0.004–0.008	0.006–0.012	0.010–0.020	0.014–0.028	0.018–0.035	115 (80-195)	–	–
M2	LNEG1003-EB45	0.004–0.008	0.006–0.012	0.010–0.020	0.014–0.028	0.018–0.035	115 (80-195)	–	–
M3	LNEG1003-EB45	0.004–0.008	0.006–0.012	0.010–0.020	0.014–0.028	0.018–0.035	115 (80-195)	–	–
M4	LNEG1003-EB45	0.004–0.008	0.006–0.012	0.010–0.020	0.014–0.028	0.018–0.035	80 (65-165)	–	–
M5	LNEG1003-EB45	0.004–0.008	0.006–0.012	0.010–0.020	0.014–0.028	0.018–0.035	80 (65-165)	–	–
K1	LNEG1003-EB45	0.008–0.020	0.006–0.018	0.010–0.030	0.010–0.041	0.018–0.053	330 (195-655)	–	720 (490-985)
K2	LNEG1003-EB45	0.008–0.020	0.006–0.018	0.010–0.030	0.010–0.041	0.018–0.053	165 (115-260)	–	230 (165-395)
K3	LNEG1003-EB45	0.008–0.020	0.006–0.018	0.010–0.030	0.010–0.041	0.018–0.053	330 (195-655)	–	720 (490-985)
K4	LNEG1003-EB45	0.008–0.020	0.006–0.018	0.010–0.030	0.010–0.041	0.018–0.053	230 (165-395)	330 (195-395)	490 (360-655)
K5	LNEG1003-EB45	0.008–0.020	0.006–0.018	0.010–0.030	0.010–0.041	0.018–0.053	230 (165-395)	330 (195-395)	490 (360-655)
K6	LNEG1003-EB45	0.008–0.020	0.006–0.018	0.010–0.030	0.010–0.041	0.018–0.053	330 (195-655)	–	720 (490-985)
K7	LNEG1003-EB45	0.008–0.020	0.006–0.018	0.010–0.030	0.010–0.041	0.018–0.053	330 (195-655)	–	720 (490-985)
H3	LNEG1003-EB45	0.004–0.008	0.004–0.010	0.006–0.016	0.010–0.020	0.012–0.028	65 (35-100)	–	–
H5	LNEG1003-EB45	0.004–0.008	0.004–0.010	0.006–0.016	0.010–0.020	0.012–0.028	65 (35-100)	–	–
H7	LNEG1003-EB45	0.004–0.008	0.004–0.010	0.006–0.016	0.010–0.020	0.012–0.028	65 (35-100)	–	–
H8	LNEG1003-EB45	0.004–0.008	0.004–0.010	0.006–0.016	0.010–0.020	0.012–0.028	65 (35-100)	–	–
H11	LNEG1003-EB45	0.004–0.008	0.004–0.010	0.006–0.016	0.010–0.020	0.012–0.028	65 (35-100)	–	–
H12	LNEG1003-EB45	0.004–0.008	0.004–0.010	0.006–0.016	0.010–0.020	0.012–0.028	65 (35-100)	–	–
H21	LNEG1003-EB45	0.004–0.008	0.004–0.010	0.006–0.016	0.010–0.020	0.012–0.028	65 (35-100)	–	–
H31	LNEG1003-EB45	0.004–0.008	0.004–0.010	0.006–0.016	0.010–0.020	0.012–0.028	65 (35-100)	–	–

SMG = Grupy materiałowe Seco

 a_p = *całowe*f = *cał/obr.* v_c = *stp/min*

Wszystkie parametry są wartościami początkowymi

Wstęp

Wiercenie

Rozwiercanie

Wylączenie

Załącznik

Parametry skrawania – LNEG...-EB845 Metryczne

SMG		a_p (Ø)	f				v_c RX2000
			z=3	z=5	z=7	z=9	
P1	LNEG1003-EB845	0,15-0,25	0,15-0,60	0,25-1	0,35-1,4	0,45-1,80	120 (80-200)
P2	LNEG1003-EB845	0,15-0,25	0,15-0,60	0,25-1	0,35-1,4	0,45-1,80	120 (80-200)
P3	LNEG1003-EB845	0,15-0,25	0,15-0,60	0,25-1	0,35-1,4	0,45-1,80	120 (80-200)
P4	LNEG1003-EB845	0,15-0,25	0,15-0,60	0,25-1	0,35-1,4	0,45-1,80	60 (40-120)
P5	LNEG1003-EB845	0,15-0,25	0,15-0,60	0,25-1	0,35-1,4	0,45-1,80	60 (40-120)
P6	LNEG1003-EB845	0,15-0,25	0,15-0,60	0,25-1	0,35-1,4	0,45-1,80	60 (40-120)
P7	LNEG1003-EB845	0,15-0,25	0,15-0,60	0,25-1	0,35-1,4	0,45-1,80	60 (40-120)
P8	LNEG1003-EB845	0,15-0,25	0,15-0,60	0,25-1	0,35-1,4	0,45-1,80	40 (30-70)
P11	LNEG1003-EB845	0,15-0,25	0,15-0,60	0,25-1	0,35-1,4	0,45-1,80	40 (30-70)
P12	LNEG1003-EB845	0,15-0,25	0,15-0,60	0,25-1	0,35-1,4	0,45-1,80	30 (25-55)
M1	LNEG1003-EB845	0,10-0,20	0,15-0,45	0,25-0,75	0,25-1,05	0,45-1,35	35 (25-60)
M2	LNEG1003-EB845	0,10-0,20	0,15-0,45	0,25-0,75	0,25-1,05	0,45-1,35	35 (25-60)
M3	LNEG1003-EB845	0,10-0,20	0,15-0,45	0,25-0,75	0,25-1,05	0,45-1,35	35 (25-60)
M4	LNEG1003-EB845	0,10-0,20	0,15-0,45	0,25-0,75	0,25-1,05	0,45-1,35	25 (20-50)
M5	LNEG1003-EB845	0,10-0,20	0,15-0,45	0,25-0,75	0,25-1,05	0,45-1,35	25 (20-50)
K1	LNEG1003-EB845	0,20-0,50	0,15-0,60	0,25-1	0,35-1,4	0,45-1,80	100 (60-200)
K2	LNEG1003-EB845	0,20-0,50	0,15-0,60	0,25-1	0,35-1,4	0,45-1,80	50 (35-80)
K3	LNEG1003-EB845	0,20-0,50	0,15-0,60	0,25-1	0,35-1,4	0,45-1,80	100 (60-200)
K4	LNEG1003-EB845	0,20-0,50	0,15-0,60	0,25-1	0,35-1,4	0,45-1,80	70 (50-120)
K5	LNEG1003-EB845	0,20-0,50	0,15-0,60	0,25-1	0,35-1,4	0,45-1,80	70 (50-120)
K6	LNEG1003-EB845	0,20-0,50	0,15-0,60	0,25-1	0,35-1,4	0,45-1,80	100 (60-200)
K7	LNEG1003-EB845	0,20-0,50	0,15-0,60	0,25-1	0,35-1,4	0,45-1,80	100 (60-200)

SMG = Grupy materiałowe Seco

a_p = mm

f = mm/obr

v_c = m/min

Wszystkie parametry są wartościami początkowymi

Wstęp

Wiercenie

Rozwiercanie

Wyłaczanie

Załącznik

Parametry skrawania – LNEG...-EB845 cale

SMG		$a_p (\varnothing)$	f				v_c RX2000
			z=3	z=5	z=7	z=9	
P1	LNEG1003-EB845	0.006–0.010	0.006–0.024	0.010–0.039	0.014–0.055	0.018–0.071	395 (260-655)
P2	LNEG1003-EB845	0.006–0.010	0.006–0.024	0.010–0.039	0.014–0.055	0.018–0.071	395 (260-655)
P3	LNEG1003-EB845	0.006–0.010	0.006–0.024	0.010–0.039	0.014–0.055	0.018–0.071	395 (260-655)
P4	LNEG1003-EB845	0.006–0.010	0.006–0.024	0.010–0.039	0.014–0.055	0.018–0.071	195 (130-395)
P5	LNEG1003-EB845	0.006–0.010	0.006–0.024	0.010–0.039	0.014–0.055	0.018–0.071	195 (130-395)
P6	LNEG1003-EB845	0.006–0.010	0.006–0.024	0.010–0.039	0.014–0.055	0.018–0.071	195 (130-395)
P7	LNEG1003-EB845	0.006–0.010	0.006–0.024	0.010–0.039	0.014–0.055	0.018–0.071	195 (130-395)
P8	LNEG1003-EB845	0.006–0.010	0.006–0.024	0.010–0.039	0.014–0.055	0.018–0.071	130 (100-230)
P11	LNEG1003-EB845	0.006–0.010	0.006–0.024	0.010–0.039	0.014–0.055	0.018–0.071	130 (100-230)
P12	LNEG1003-EB845	0.006–0.010	0.006–0.024	0.010–0.039	0.014–0.055	0.018–0.071	100 (85-185)
M1	LNEG1003-EB845	0.004–0.008	0.006–0.018	0.010–0.030	0.010–0.041	0.018–0.053	115 (80-195)
M2	LNEG1003-EB845	0.004–0.008	0.006–0.018	0.010–0.030	0.010–0.041	0.018–0.053	115 (80-195)
M3	LNEG1003-EB845	0.004–0.008	0.006–0.018	0.010–0.030	0.010–0.041	0.018–0.053	115 (80-195)
M4	LNEG1003-EB845	0.004–0.008	0.006–0.018	0.010–0.030	0.010–0.041	0.018–0.053	80 (65-165)
M5	LNEG1003-EB845	0.004–0.008	0.006–0.018	0.010–0.030	0.010–0.041	0.018–0.053	80 (65-165)
K1	LNEG1003-EB845	0.008–0.020	0.006–0.024	0.010–0.039	0.014–0.055	0.018–0.071	330 (195-655)
K2	LNEG1003-EB845	0.008–0.020	0.006–0.024	0.010–0.039	0.014–0.055	0.018–0.071	165 (115-260)
K3	LNEG1003-EB845	0.008–0.020	0.006–0.024	0.010–0.039	0.014–0.055	0.018–0.071	330 (195-655)
K4	LNEG1003-EB845	0.008–0.020	0.006–0.024	0.010–0.039	0.014–0.055	0.018–0.071	230 (165-395)
K5	LNEG1003-EB845	0.008–0.020	0.006–0.024	0.010–0.039	0.014–0.055	0.018–0.071	230 (165-395)
K6	LNEG1003-EB845	0.008–0.020	0.006–0.024	0.010–0.039	0.014–0.055	0.018–0.071	330 (195-655)
K7	LNEG1003-EB845	0.008–0.020	0.006–0.024	0.010–0.039	0.014–0.055	0.018–0.071	330 (195-655)

SMG = Grupy materiałowe Seco

 a_p = calowe

f = cal/obr.

 v_c = stp/min

Wszystkie parametry są wartościami początkowymi

Parametry skrawania – LNEG...-EB1570 Metryczne

SMG		a_p (∅)	f				v_c RX2000
			z=3	z=5	z=7	z=9	
P4	LNEG1005-EB1570	0,15-0,25	0,15-0,45	0,25-0,75	0,25-1,05	0,45-1,35	60 (40-120)
P5	LNEG1005-EB1570	0,15-0,25	0,15-0,45	0,25-0,75	0,25-1,05	0,45-1,35	60 (40-120)
P6	LNEG1005-EB1570	0,15-0,25	0,15-0,45	0,25-0,75	0,25-1,05	0,45-1,35	60 (40-120)
P7	LNEG1005-EB1570	0,15-0,25	0,15-0,45	0,25-0,75	0,25-1,05	0,45-1,35	60 (40-120)
P8	LNEG1005-EB1570	0,15-0,25	0,15-0,45	0,25-0,75	0,25-1,05	0,45-1,35	40 (30-70)
P11	LNEG1005-EB1570	0,15-0,25	0,15-0,45	0,25-0,75	0,25-1,05	0,45-1,35	40 (30-70)
P12	LNEG1005-EB1570	0,15-0,25	0,15-0,45	0,25-0,75	0,25-1,05	0,45-1,35	30 (25-55)
K1	LNEG1005-EB1570	0,20-0,50	0,15-0,45	0,25-0,75	0,25-1,05	0,45-1,35	100 (60-200)
K2	LNEG1005-EB1570	0,20-0,50	0,15-0,45	0,25-0,75	0,25-1,05	0,45-1,35	50 (35-80)
K3	LNEG1005-EB1570	0,20-0,50	0,15-0,45	0,25-0,75	0,25-1,05	0,45-1,35	100 (60-200)
K4	LNEG1005-EB1570	0,20-0,50	0,15-0,45	0,25-0,75	0,25-1,05	0,45-1,35	70 (50-120)
K5	LNEG1005-EB1570	0,20-0,50	0,15-0,45	0,25-0,75	0,25-1,05	0,45-1,35	70 (50-120)
K6	LNEG1005-EB1570	0,20-0,50	0,15-0,45	0,25-0,75	0,25-1,05	0,45-1,35	100 (60-200)
K7	LNEG1005-EB1570	0,20-0,50	0,15-0,45	0,25-0,75	0,25-1,05	0,45-1,35	100 (60-200)

SMG = Grupy materiałowe Seco

a_p = mm

f = mm/obr

v_c = m/min

Wszystkie parametry są wartościami początkowymi

Parametry skrawania – LNEG...-EB1570 cale

SMG		a_p (∅)	f				v_c RX2000
			z=3	z=5	z=7	z=9	
P4	LNEG1005-EB1570	0.006–0.010	0.006–0.018	0.010–0.030	0.010–0.041	0.018–0.053	195 (130–395)
P5	LNEG1005-EB1570	0.006–0.010	0.006–0.018	0.010–0.030	0.010–0.041	0.018–0.053	195 (130–395)
P6	LNEG1005-EB1570	0.006–0.010	0.006–0.018	0.010–0.030	0.010–0.041	0.018–0.053	195 (130–395)
P7	LNEG1005-EB1570	0.006–0.010	0.006–0.018	0.010–0.030	0.010–0.041	0.018–0.053	195 (130–395)
P8	LNEG1005-EB1570	0.006–0.010	0.006–0.018	0.010–0.030	0.010–0.041	0.018–0.053	130 (100–230)
P11	LNEG1005-EB1570	0.006–0.010	0.006–0.018	0.010–0.030	0.010–0.041	0.018–0.053	130 (100–230)
P12	LNEG1005-EB1570	0.006–0.010	0.006–0.018	0.010–0.030	0.010–0.041	0.018–0.053	100 (85–185)
K1	LNEG1005-EB1570	0.008–0.020	0.006–0.018	0.010–0.030	0.010–0.041	0.018–0.053	330 (195–655)
K2	LNEG1005-EB1570	0.008–0.020	0.006–0.018	0.010–0.030	0.010–0.041	0.018–0.053	165 (115–260)
K3	LNEG1005-EB1570	0.008–0.020	0.006–0.018	0.010–0.030	0.010–0.041	0.018–0.053	330 (195–655)
K4	LNEG1005-EB1570	0.008–0.020	0.006–0.018	0.010–0.030	0.010–0.041	0.018–0.053	230 (165–395)
K5	LNEG1005-EB1570	0.008–0.020	0.006–0.018	0.010–0.030	0.010–0.041	0.018–0.053	230 (165–395)
K6	LNEG1005-EB1570	0.008–0.020	0.006–0.018	0.010–0.030	0.010–0.041	0.018–0.053	330 (195–655)
K7	LNEG1005-EB1570	0.008–0.020	0.006–0.018	0.010–0.030	0.010–0.041	0.018–0.053	330 (195–655)

SMG = Grupy materiałowe Seco

a_p = calowe

f = cal/obr.

v_c = stp/min

Wszystkie parametry są wartościami początkowymi

Wstęp

Wfrczenie

Rozwiercanie

Wyfrazowanie

Zalacznik

Parametry skrawania – RNAX...-EB45 Metryczne

SMG		$a_p (\varnothing)$	f				v_c	
			z=3	z=5	z=6	z=9	RX2000	RX1500
K1	RNAX1005-EB45	0,20-0,50	0,15-0,45	0,25-0,75	0,25-1,05	0,45-1,35	100 (60-200)	220 (150-300)
K2	RNAX1005-EB45	0,20-0,50	0,15-0,45	0,25-0,75	0,25-1,05	0,45-1,35	50 (35-80)	70 (50-120)
K3	RNAX1005-EB45	0,20-0,50	0,15-0,45	0,25-0,75	0,25-1,05	0,45-1,35	100 (60-200)	220 (150-300)
K4	RNAX1005-EB45	0,20-0,50	0,15-0,45	0,25-0,75	0,25-1,05	0,45-1,35	70 (50-120)	150 (110-200)
K5	RNAX1005-EB45	0,20-0,50	0,15-0,45	0,25-0,75	0,25-1,05	0,45-1,35	70 (50-120)	150 (110-200)
K6	RNAX1005-EB45	0,20-0,50	0,15-0,45	0,25-0,75	0,25-1,05	0,45-1,35	100 (60-200)	220 (150-300)
K7	RNAX1005-EB45	0,20-0,50	0,15-0,45	0,25-0,75	0,25-1,05	0,45-1,35	100 (60-200)	220 (150-300)

SMG = Grupy materiałowe Seco

 a_p = mm

f = mm/obr

 v_c = m/min

Wszystkie parametry są wartościami początkowymi

Parametry skrawania – RNAX...-EB45 cale

SMG		$a_p (\varnothing)$	f				v_c	
			z=3	z=5	z=6	z=9	RX2000	RX1500
K1	RNAX1005-EB45	0.008–0.020	0.006–0.018	0.010–0.030	0.010–0.041	0.018–0.053	330 (195-655)	720 (490-985)
K2	RNAX1005-EB45	0.008–0.020	0.006–0.018	0.010–0.030	0.010–0.041	0.018–0.053	165 (115-260)	230 (165-395)
K3	RNAX1005-EB45	0.008–0.020	0.006–0.018	0.010–0.030	0.010–0.041	0.018–0.053	330 (195-655)	720 (490-985)
K4	RNAX1005-EB45	0.008–0.020	0.006–0.018	0.010–0.030	0.010–0.041	0.018–0.053	230 (165-395)	490 (360-655)
K5	RNAX1005-EB45	0.008–0.020	0.006–0.018	0.010–0.030	0.010–0.041	0.018–0.053	230 (165-395)	490 (360-655)
K6	RNAX1005-EB45	0.008–0.020	0.006–0.018	0.010–0.030	0.010–0.041	0.018–0.053	330 (195-655)	720 (490-985)
K7	RNAX1005-EB45	0.008–0.020	0.006–0.018	0.010–0.030	0.010–0.041	0.018–0.053	330 (195-655)	720 (490-985)

SMG = Grupy materiałowe Seco

 a_p = calowe

f = cal/obr.

 v_c = stp/min

Wszystkie parametry są wartościami początkowymi

Parametry skrawania – RNAX...-EB845 Metryczne

SMG		a_p (°)	f				v_c	
			z=3	z=5	z=6	z=9	RX2000	RX1500
K1	RNAX1005-EB845	0,20-0,50	0,15-0,60	0,25-1	0,35-1,4	0,45-1,80	100 (60-200)	220 (150-300)
K2	RNAX1005-EB845	0,20-0,50	0,15-0,60	0,25-1	0,35-1,4	0,45-1,80	50 (35-80)	70 (50-120)
K3	RNAX1005-EB845	0,20-0,50	0,15-0,60	0,25-1	0,35-1,4	0,45-1,80	100 (60-200)	220 (150-300)
K4	RNAX1005-EB845	0,20-0,50	0,15-0,60	0,25-1	0,35-1,4	0,45-1,80	70 (50-120)	150 (110-200)
K5	RNAX1005-EB845	0,20-0,50	0,15-0,60	0,25-1	0,35-1,4	0,45-1,80	70 (50-120)	150 (110-200)
K6	RNAX1005-EB845	0,20-0,50	0,15-0,60	0,25-1	0,35-1,4	0,45-1,80	100 (60-200)	220 (150-300)
K7	RNAX1005-EB845	0,20-0,50	0,15-0,60	0,25-1	0,35-1,4	0,45-1,80	100 (60-200)	220 (150-300)

SMG = Grupy materiałowe Seco

a_p = mm

f = mm/obr

v_c = m/min

Wszystkie parametry są wartościami początkowymi

Parametry skrawania – RNAX...-EB845 cale

SMG		a_p (°)	f				v_c	
			z=3	z=5	z=6	z=9	RX2000	RX1500
K1	RNAX1005-EB845	0.008–0.020	0.006–0.024	0.010–0.039	0.014–0.055	0.018–0.071	330 (195-655)	720 (490-985)
K2	RNAX1005-EB845	0.008–0.020	0.006–0.024	0.010–0.039	0.014–0.055	0.018–0.071	165 (115-260)	230 (165-395)
K3	RNAX1005-EB845	0.008–0.020	0.006–0.024	0.010–0.039	0.014–0.055	0.018–0.071	330 (195-655)	720 (490-985)
K4	RNAX1005-EB845	0.008–0.020	0.006–0.024	0.010–0.039	0.014–0.055	0.018–0.071	230 (165-395)	490 (360-655)
K5	RNAX1005-EB845	0.008–0.020	0.006–0.024	0.010–0.039	0.014–0.055	0.018–0.071	230 (165-395)	490 (360-655)
K6	RNAX1005-EB845	0.008–0.020	0.006–0.024	0.010–0.039	0.014–0.055	0.018–0.071	330 (195-655)	720 (490-985)
K7	RNAX1005-EB845	0.008–0.020	0.006–0.024	0.010–0.039	0.014–0.055	0.018–0.071	330 (195-655)	720 (490-985)

SMG = Grupy materiałowe Seco

a_p = calowe

f = cal/obr.

v_c = stp/min

Wszystkie parametry są wartościami początkowymi

Parametry skrawania – RNAX...-EB1570 Metryczne

SMG		$a_p (\varnothing)$	f				v_c	
			z=3	z=5	z=6	z=9	RX2000	RX1500
K1	RNAX1005-EB1570	0,20-0,50	0,15-0,45	0,25-0,75	0,25-1,05	0,45-1,35	100 (60-200)	220 (150-300)
K2	RNAX1005-EB1570	0,20-0,50	0,15-0,45	0,25-0,75	0,25-1,05	0,45-1,35	50 (35-80)	70 (50-120)
K3	RNAX1005-EB1570	0,20-0,50	0,15-0,45	0,25-0,75	0,25-1,05	0,45-1,35	100 (60-200)	220 (150-300)
K4	RNAX1005-EB1570	0,20-0,50	0,15-0,45	0,25-0,75	0,25-1,05	0,45-1,35	70 (50-120)	150 (110-200)
K5	RNAX1005-EB1570	0,20-0,50	0,15-0,45	0,25-0,75	0,25-1,05	0,45-1,35	70 (50-120)	150 (110-200)
K6	RNAX1005-EB1570	0,20-0,50	0,15-0,45	0,25-0,75	0,25-1,05	0,45-1,35	100 (60-200)	220 (150-300)
K7	RNAX1005-EB1570	0,20-0,50	0,15-0,45	0,25-0,75	0,25-1,05	0,45-1,35	100 (60-200)	220 (150-300)

SMG = Grupy materiałowe Seco

 a_p = mm

f = mm/obr

 v_c = m/min

Wszystkie parametry są wartościami początkowymi

Parametry skrawania – RNAX...-EB1570 cale

SMG		$a_p (\varnothing)$	f				v_c	
			z=3	z=5	z=6	z=9	RX2000	RX1500
K1	RNAX1005-EB1570	0.008–0.020	0.006–0.018	0.010–0.030	0.010–0.041	0.018–0.053	330 (195-655)	720 (490-985)
K2	RNAX1005-EB1570	0.008–0.020	0.006–0.018	0.010–0.030	0.010–0.041	0.018–0.053	165 (115-260)	230 (165-395)
K3	RNAX1005-EB1570	0.008–0.020	0.006–0.018	0.010–0.030	0.010–0.041	0.018–0.053	330 (195-655)	720 (490-985)
K4	RNAX1005-EB1570	0.008–0.020	0.006–0.018	0.010–0.030	0.010–0.041	0.018–0.053	230 (165-395)	490 (360-655)
K5	RNAX1005-EB1570	0.008–0.020	0.006–0.018	0.010–0.030	0.010–0.041	0.018–0.053	230 (165-395)	490 (360-655)
K6	RNAX1005-EB1570	0.008–0.020	0.006–0.018	0.010–0.030	0.010–0.041	0.018–0.053	330 (195-655)	720 (490-985)
K7	RNAX1005-EB1570	0.008–0.020	0.006–0.018	0.010–0.030	0.010–0.041	0.018–0.053	330 (195-655)	720 (490-985)

SMG = Grupy materiałowe Seco

 a_p = calowe

f = cal/obr.

 v_c = stp/min

Wszystkie parametry są wartościami początkowymi

Instrukcje odnośnie regulacji

1.

- Poluzować śrubę mocującą wkładkę.
- Obrócić lub wymienić płytkę.
- Odkręcić śrubę regulacyjną o 1/4 obrotu i wcisnąć wkładkę z powrotem.
- Delikatnie ponownie zaciśnąć śrubę wkładki momentem ok. 0,5 Nm (4.4 cala/funta).

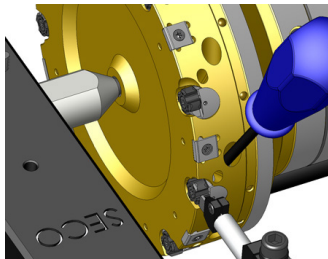

Śruba mocująca kasetę
Śruba regulacyjna

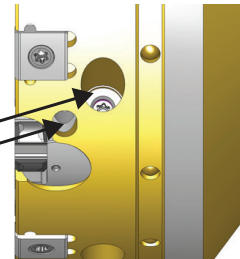

2.

- Wyzerować czujnik zegarowy na prowadnicy referencyjnej.
- Upewnić się iż punkt pomiarowy leży za kątem przystawienia.

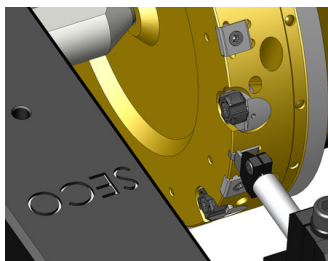

Podatna prowadnica
Prowadnica referencyjna do regulacji

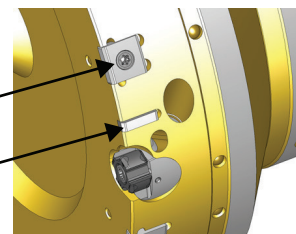
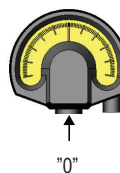

3.

- Ustawić płytkę 0,025 mm (0.001") powyżej prowadnicy referencyjnej przy użyciu śruby regulacyjnej.
- Powtórzyć proces regulacji dla wszystkich płytek.

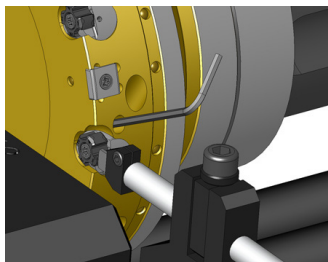

Śruba regulacyjna

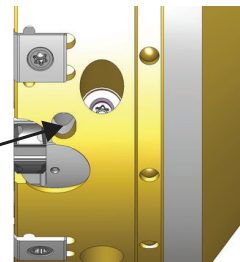

4.

- Ostatecznie dokręcić śrubę mocującą wkładki momentem 2 Nm (17.7 cala/funta).

Śruba mocująca kasetę



Uwaga: Jeśli wymagana średnica została przekroczona podczas ustawiania, cały proces należy powtórzyć od początku celem eliminacji luzów na śrubach regulacyjnych.

Instrukcje regulacyjne – adapter

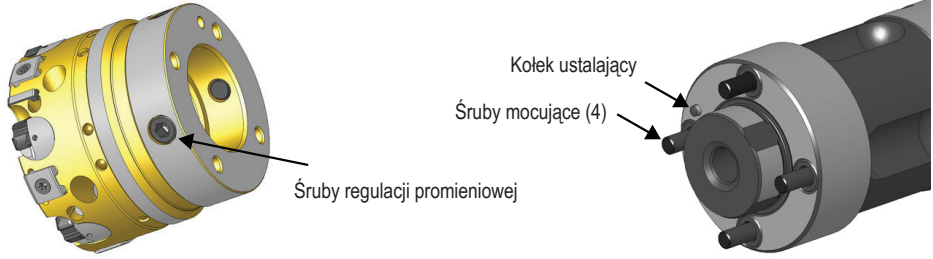
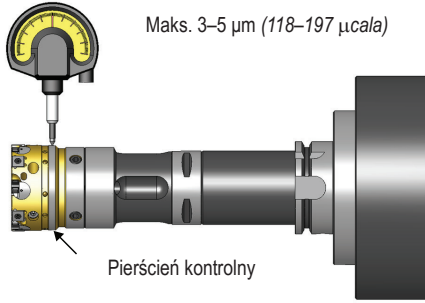
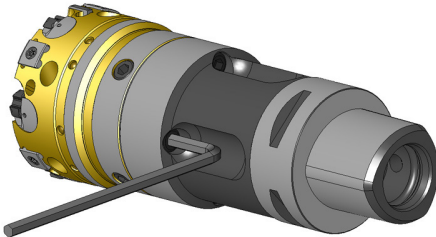
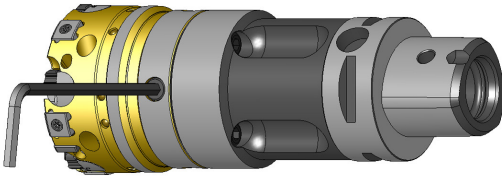
<p>1.</p> <p>Montaż</p> <ul style="list-style-type: none"> • Dokładnie oczyścić powierzchnie styku kołnierza. • Poluzować 4 śruby regulacji promieniowej, aby nie przeszkadzały w montażu. • Założyć głowicę rozwiertaka na adapter (kołek ustalający) i dokręcić 4 śruby mocujące. 	<p>Montaż (rys. 1)</p> 																																				
<p>2.</p> <p>USTAWIANIE</p> <ul style="list-style-type: none"> • Zamocować narzędzie we wrzecionie. • Umieścić czujnik zegarowy, jak pokazano na rys. 2. • Odblokuj wrzeciono tak aby można było swobodnie obracać. • Rozpocznij korekcję bicia za pomocą 4 śrub (patrz rys. 3). • Maksymalne bicie 5 μm (197 μcala). • Gdy bicie zejdzie poniżej 10 μm 394 μcala, należy rozpocząć końcowe mocowanie (rys. 1) patrz tabela zalecanych momentów mocowania. 	<p>Operacja ustawiania we wrzecionie obrabiarki (rys. 2)</p>  <p>Śruby mocujące (rys. 3)</p> 																																				
<p>3.</p> <ul style="list-style-type: none"> • Zakończyć regulację bicia, maks. 5 μm (maks. 197 μcala). 	<p>Śruby regulacji promieniowej (rys. 4)</p>  <table border="1" data-bbox="545 1843 1490 2085"> <thead> <tr> <th colspan="6">Tablica momentów mocowania</th> </tr> <tr> <th>Średnica mm</th> <th>Średnica cale</th> <th>Wielkość adaptera</th> <th>Śruba mocująca</th> <th>Moment mocowania Nm</th> <th>Moment mocowania cale-funty</th> </tr> </thead> <tbody> <tr> <td>39,5-59 499</td> <td>1.555-2.342</td> <td>HF32</td> <td>CHC M3 x 16</td> <td>2,7</td> <td>24</td> </tr> <tr> <td>59,5-84 499</td> <td>2.342-3.372</td> <td>HF55</td> <td>CHC M5 x 25</td> <td>5,7</td> <td>50</td> </tr> <tr> <td>84,5-119 499</td> <td>3.372-4.705</td> <td>HF80</td> <td>CHC M6 x 25</td> <td>9,8</td> <td>87</td> </tr> <tr> <td>119,5-154 499</td> <td>4.705-6.083</td> <td>HF100</td> <td>CHC M8 x 30</td> <td>24</td> <td>212</td> </tr> </tbody> </table>	Tablica momentów mocowania						Średnica mm	Średnica cale	Wielkość adaptera	Śruba mocująca	Moment mocowania Nm	Moment mocowania cale-funty	39,5-59 499	1.555-2.342	HF32	CHC M3 x 16	2,7	24	59,5-84 499	2.342-3.372	HF55	CHC M5 x 25	5,7	50	84,5-119 499	3.372-4.705	HF80	CHC M6 x 25	9,8	87	119,5-154 499	4.705-6.083	HF100	CHC M8 x 30	24	212
Tablica momentów mocowania																																					
Średnica mm	Średnica cale	Wielkość adaptera	Śruba mocująca	Moment mocowania Nm	Moment mocowania cale-funty																																
39,5-59 499	1.555-2.342	HF32	CHC M3 x 16	2,7	24																																
59,5-84 499	2.342-3.372	HF55	CHC M5 x 25	5,7	50																																
84,5-119 499	3.372-4.705	HF80	CHC M6 x 25	9,8	87																																
119,5-154 499	4.705-6.083	HF100	CHC M8 x 30	24	212																																

Przyrząd do ustawiania — pojedynczy czujnik

SF-210340-C160: Numer produktu 02885391

- Stanowisko poziome
- Pierwszy wybór dla rozwiertaków Xfix
- 1 czujniki
- Maksymalne \varnothing narzędzia: 210 mm (8.268")
- Maksymalna długość narzędzia: 340 mm (13.386")
- Zawarte w dostawie: dodatkowe mocowanie \varnothing 57 mm (2.244") do HSK 63/80/100 i Capto C8 SSC5700, nr prod. 02208620

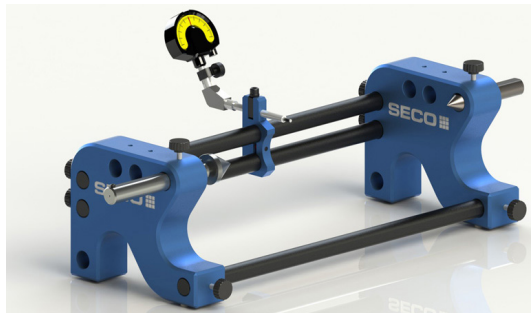

SF-210290V-C160: Numer produktu 02885392

- Stanowisko pionowe
- Pierwszy wybór dla rozwiertaków Xfix
- Maksymalne \varnothing narzędzia: 210 mm (8.268")
- Maksymalna długość narzędzia: 290 mm (11.417")
- Zawarte w dostawie: dodatkowe mocowanie \varnothing 57 mm (2.244") do HSK 63/80/100 i Capto C8 SSC5700, nr prod. 02208620

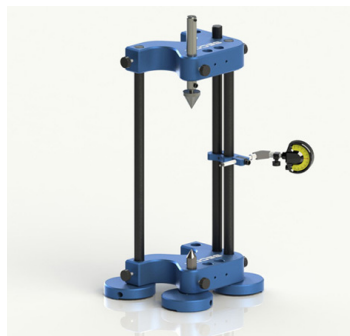

Przyrząd do ustawiania — wiele czujników

Więcej informacji patrz rozdział przyrządy ustawcze str. 486-491

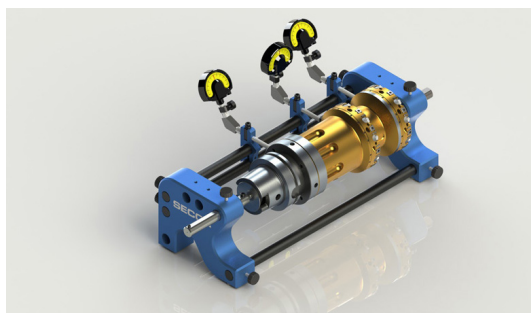

Przegląd oprawek

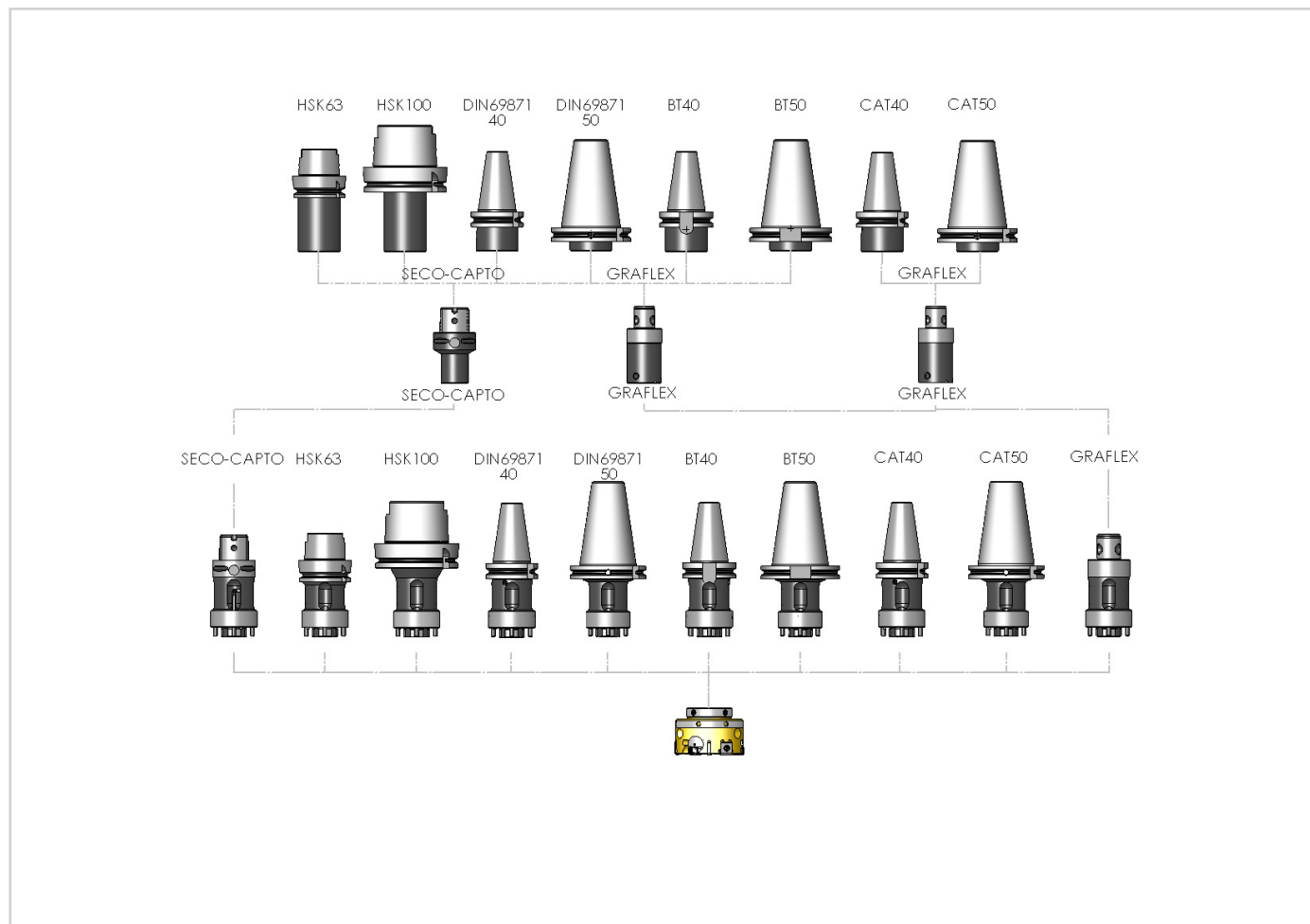

Średnica mm	Średnica cale	Stos. maks śred./ długość
39,5-59 499	1.555-2.342	6,5 x D
59.5-84 499	2.342-3.372	4,5 x D
84.5-119 499	3.372-4.705	3,3 x D
119.5-154 499	4.705-6.083	2,5 x D

Uwaga: Dla średnic > 100 mm (3.937") lub L > 3 x D sprawdź dopuszczalną wagę narzędzia dla obrabiarki.

Narzędzia obrotowe

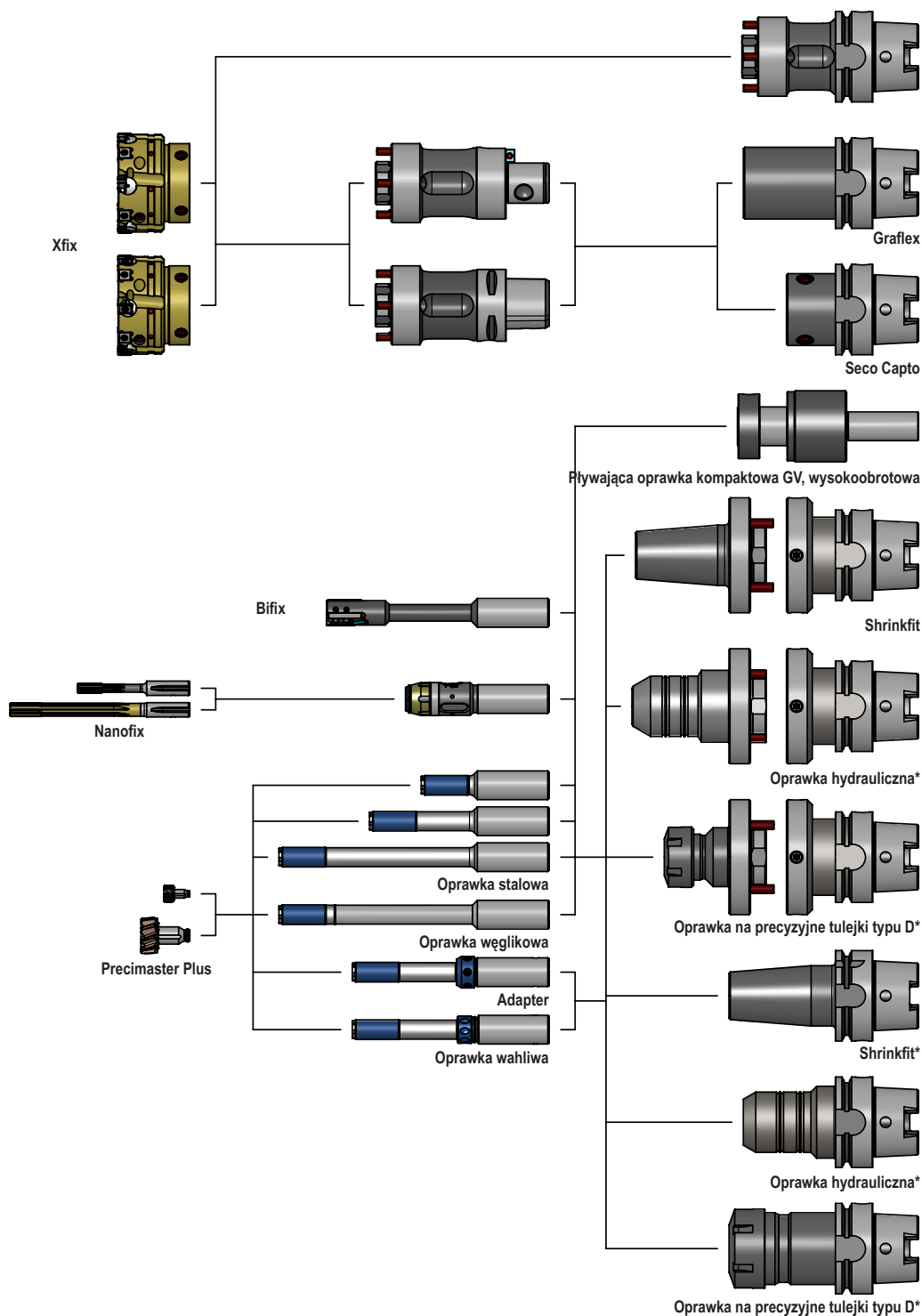

*Patrz katalog Systemy Narzędziowe

Najlepsze osiągi można uzyskać przy montażu sztywnym (Oprawka hydrauliczna, typu D lub Shrinkfit)

Narzędzia nieobrotowe

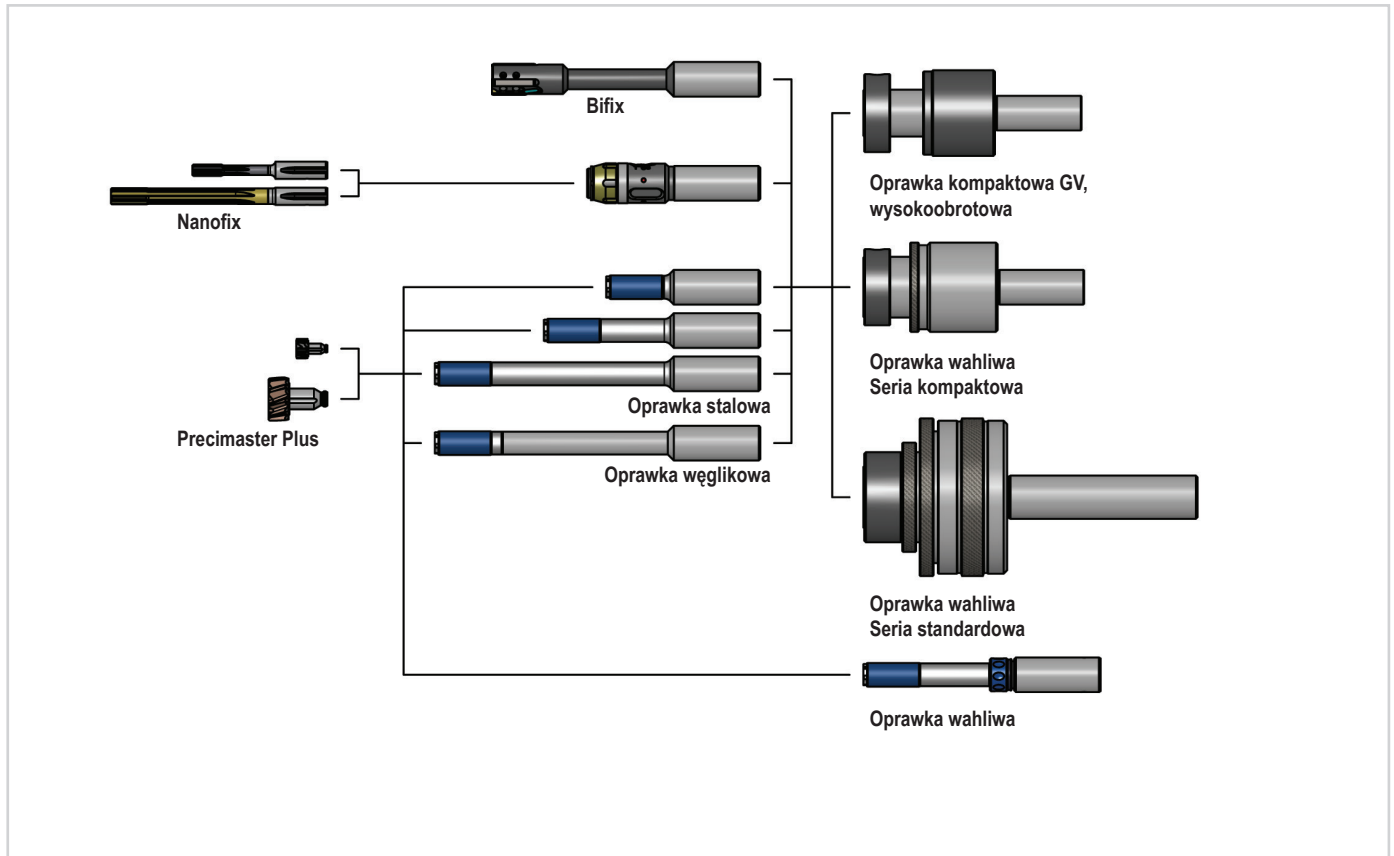

Wielkość kołnierza

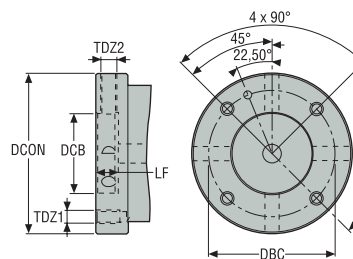

DCON	DCB +/- 0,1	DCB F8	LF	TDZ1	TDZ2
60	44	30	12	M5	M8x1
70	53	35	12	M6	M8x1
80	63	40	12	M6	M8x1
100	79	50	14	M8	M10x1
117	96	60	14	M8	M10x1
140	119	80	14	M10	M10x1

Stożek HSK-A

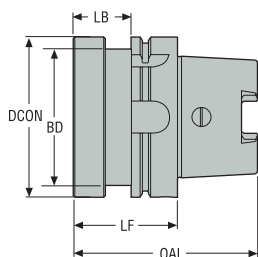

- Uwaga: Przewód do chłodziwa i śruby zawarte w dostawie

Oznaczenie	Numer produktu	Stożek	DCON	BD	LB	LF	OAL	Waga
			mm Cal.	mm Cal.	mm Cal.	mm Cal.	mm Cal.	kg lbs
SAH-23405100001	02836663	HSK-A 100	60,0 2.362	60,0 2.362	26,0 1.024	55,0 2.165	105,0 4.134	2,5 5.510
SAH-23405100002	02836665	HSK-A 100	80,0 3.150	80,0 3.150	26,0 1.024	55,0 2.165	105,0 4.134	2,9 6.390
SAH-23405100003	02836666	HSK-A 100	100,0 3.937	85,0 3.346	36,0 1.417	65,0 2.559	115,0 4.528	3,5 7.720
SAH-23405100007	02836664	HSK-A 100	70,0 2.756	70,0 2.756	26,0 1.024	55,0 2.165	105,0 4.134	2,8 6.170
SAH-2340540001	02836564	HSK-A 40	60,0 2.362	34,0 1.339	35,0 1.378	55,0 2.165	75,0 2.953	0,8 1.760
SAH-2340550001	02836566	HSK-A 50	60,0 2.362	42,0 1.654	34,0 1.339	60,0 2.362	85,0 3.346	0,95 2.090
SAH-2340550002	02836573	HSK-A 50	80,0 3.150	42,0 1.654	34,0 1.339	60,0 2.362	85,0 3.346	1,2 2.650
SAH-2340550003	02836567	HSK-A 50	70,0 2.756	42,0 1.654	34,0 1.339	60,0 2.362	85,0 3.346	1,0 2.200
SAH-2340563001	02836574	HSK-A 63	60,0 2.362	53,0 2.087	34,0 1.339	60,0 2.362	92,0 3.622	1,2 2.650
SAH-2340563002	02836576	HSK-A 63	80,0 3.150	53,0 2.087	34,0 1.339	60,0 2.362	92,0 3.622	1,4 3.090
SAH-2340563003	02836575	HSK-A 63	70,0 2.756	53,0 2.087	34,0 1.339	60,0 2.362	92,0 3.622	1,3 2.870
SAH-2340563004	02836577	HSK-A 63	100,0 3.937	53,0 2.087	39,0 1.535	65,0 2.559	97,0 3.819	1,95 4.300
SAH-2340580001	02836655	HSK-A 80	60,0 2.362	60,0 2.362	24,0 0.945	50,0 1.969	90,0 3.543	1,4 3.090
SAH-2340580002	02836658	HSK-A 80	80,0 3.150	67,0 2.638	34,0 1.339	60,0 2.362	100,0 3.937	1,6 3.530
SAH-2340580003	02836657	HSK-A 80	70,0 2.756	67,0 2.638	34,0 1.339	60,0 2.362	100,0 3.937	1,5 3.310
SAH-2340580004	02836660	HSK-A 80	100,0 3.937	67,0 2.638	39,0 1.535	65,0 2.559	105,0 4.134	2,2 4.850

Części zamienne, zawarte w dostawie

Dla DCON	Śruba regulacyjna	Śruba mocująca
60	HCM8X12X1/ISO4028	CHCM5X20/ISO4762
70	HCM8X16X1/ISO4028	CHCM6X20/ISO4762
80	HCM8X16X1/ISO4028	CHCM6X25/ISO4762
100	HCM10X20X1/ISO4028	CHCM8X25/ISO4762

Stożek DIN 69871

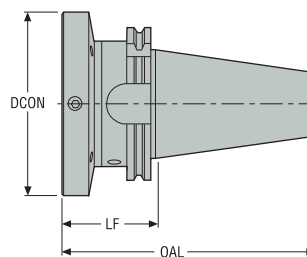

- Uwaga: Śruby zawarte w dostawie

Oznaczenie	Numer produktu	Stożek	DCON	LF	OAL	Waga
			mm Cal.	mm Cal.	mm Cal.	kg lbs
SAH-2340640201	02836683	DIN40 ADB	60,0 2.362	50,0 1.969	118,4 4.661	1,1 2.430
SAH-2340640202	02836685	DIN40 ADB	80,0 3.150	55,0 2.165	123,4 4.858	1,7 3.750
SAH-2340640203	02836686	DIN40 ADB	100,0 3.937	60,0 2.362	128,4 5.055	2,3 5.070
SAH-2340640204	02836684	DIN40 ADB	70,0 2.756	50,0 1.969	118,4 4.661	1,2 2.650
SAH-2340650201	02836687	DIN50 ADB	60,0 2.362	50,0 1.969	151,8 5.976	3,1 6.830
SAH-2340650202	02836690	DIN50 ADB	80,0 3.150	50,0 1.969	151,8 5.976	3,5 7.720
SAH-2340650203	02836691	DIN50 ADB	100,0 3.937	60,0 2.362	161,8 6.370	4,3 9.480
SAH-2340650206	02836688	DIN50 ADB	70,0 2.756	50,0 1.969	151,8 5.976	3,3 7.280

Części zamienne, zawarte w dostawie

Dla DCON	Śruba regulacyjna	Śruba mocująca
60	HCM8X12X1/ISO4028	CHCM5X20/ISO4762
70	HCM8X16X1/ISO4028	CHCM6X20/ISO4762
80	HCM8X16X1/ISO4028	CHCM6X25/ISO4762
100	HCM10X20X1/ISO4028	CHCM8X25/ISO4762

Stożek ANSI CAT

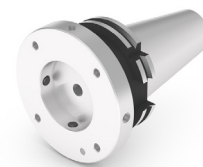
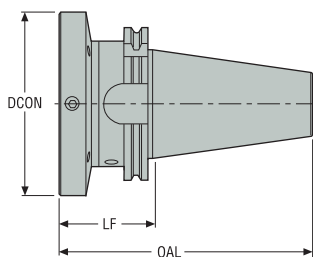

- Uwaga: Śruby zawarte w dostawie
- Gwint śruby ściągającej — calowe

Oznaczenie	Numer produktu	Stożek	DCON		LF		OAL		Waga	
			mm	Cal.	mm	Cal.	mm	Cal.	kg	lbs
SAH-2784940201	02836698	CAT 40	60,0	2.362	50,0	1.969	118,4	4.661	1,1	2.430
SAH-2784940202	02836702	CAT 40	80,0	3.150	55,0	2.165	123,4	4.858	1,8	3.970
SAH-2784940203	02836704	CAT 40	100,0	3.937	60,0	2.362	128,4	5.055	2,3	5.070
SAH-2784950201	02836707	CAT 50	60,0	2.362	50,0	1.969	151,8	5.976	3,1	6.830
SAH-2784950202	02836709	CAT 50	80,0	3.150	50,0	1.969	151,8	5.976	3,4	7.500
SAH-2784950203	02836710	CAT 50	100,0	3.937	60,0	2.362	161,8	6.370	5,5	12.130
SAH-2784950206	02836708	CAT 50	70,0	2.756	50,0	1.969	151,8	5.976	3,3	7.280

Części zamienne, zawarte w dostawie

Dla DCON	Śruba regulacyjna	Śruba mocująca
60	HCM8X12X1//ISO4028	CHCM5X20//ISO4762
70	HCM8X16X1//ISO4028	CHCM6X20//ISO4762
80	HCM8X16X1//ISO4028	CHCM6X25//ISO4762
100	HCM10X20X1//ISO4028	CHCM8X25//ISO4762

Stożek BT

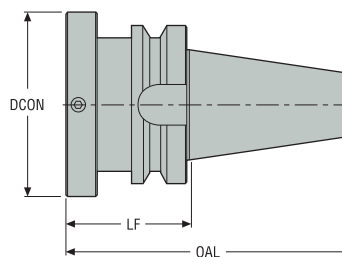
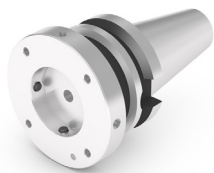

- Uwaga: Śruby zawarte w dostawie

Oznaczenie	Numer produktu	Stożek	DCON	LF	OAL	Waga
			mm Cal.	mm Cal.	mm Cal.	kg lbs
SAH-2340740001	02836717	BT40 ADB	60,0 2.362	55,0 2.165	120,4 4.740	1,4 3.090
SAH-2340740002	02836719	BT40 ADB	80,0 3.150	65,0 2.559	130,4 5.134	2,0 4.410
SAH-2340740003	02836721	BT40 ADB	100,0 3.937	60,0 2.362	125,4 4.937	2,7 5.950
SAH-2340740004	02836718	BT40 ADB	70,0 2.756	55,0 2.165	120,4 4.740	1,5 3.310
SAH-2340750001	02836724	BT50 ADB	60,0 2.362	70,0 2.756	171,8 6.764	4,2 9.260
SAH-2340750002	02836725	BT50 ADB	70,0 2.756	70,0 2.756	171,8 6.764	4,4 9.700
SAH-2340750003	02836726	BT50 ADB	80,0 3.150	70,0 2.756	171,8 6.764	4,6 10.140
SAH-2340750004	02836727	BT50 ADB	100,0 3.937	70,0 2.756	171,8 6.764	4,9 10.800

Części zamienne, zawarte w dostawie

Dla DCON	Śruba regulacyjna	Śruba mocująca
60	HCM8X12X1/ISO4028	CHCM5X20/ISO4762
70	HCM8X16X1/ISO4028	CHCM6X20/ISO4762
80	HCM8X16X1/ISO4028	CHCM6X25/ISO4762
100	HCM10X20X1/ISO4028	CHCM8X25/ISO4762

Z uchwytem termokurczliwym

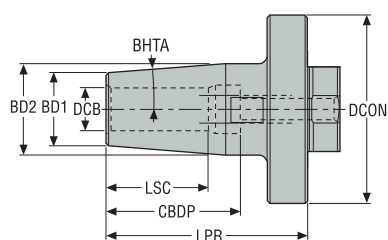

- Uwaga: Śruby regulacyjne zawarte w dostawie

Oznaczenie	Numer produktu	DCON	BD2	BD1	DCB	LSC	CBDP	LPR	Waga	BHTA°
		mm Cal.	mm Cal.	mm Cal.	mm Cal.	mm Cal.	mm Cal.	mm Cal.	kg lbs	
SAH-2341006235	02836735	60,0 2.362	27,0 1.063	21,0 0.827	6,0 0.236	22,0 0.866	37,5 1.476	70,0 2.756	0,5 1.100	4.5
SAH-2341010237	02836736	60,0 2.362	32,0 1.260	24,0 0.945	10,0 0.394	31,0 1.220	42,5 1.673	70,0 2.756	0,5 1.100	4.5
SAH-2341012238	02836737	60,0 2.362	32,0 1.260	24,0 0.945	12,0 0.472	34,0 1.339	47,5 1.870	70,0 2.756	0,52 1.150	4.5
SAH-2341016241	02836741	70,0 2.756	34,0 1.339	27,0 1.063	16,0 0.630	39,0 1.535	50,5 1.988	75,0 2.953	0,7 1.540	4.5
SAH-2341020251	02836742	80,0 3.150	42,0 1.654	33,0 1.299	20,0 0.787	41,0 1.614	52,5 2.067	80,0 3.150	1,0 2.200	4.5
SAH-2341025260	02836743	100,0 3.937	53,0 2.087	44,0 1.732	25,0 0.984	47,0 1.850	58,5 2.303	80,0 3.150	2,2 4.850	4.5
SAH-2341032261	02836744	100,0 3.937	53,0 2.087	44,0 1.732	32,0 1.260	51,0 2.008	62,5 2.461	80,0 3.150	2,5 5.510	4.5

Części zamienne, zawarte w dostawie

Dla DCON	Śruba regulacyjna
60	HCM6X12/ISO4028
70	HCM6X16/ISO4028
80	HCM6X16/ISO4028
100	HCM8X12X1/ISO4028



Z uchwytem hydraulicznym

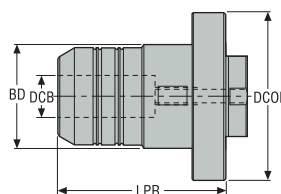

- Uwaga: Śruby regulacyjne zawarte w dostawie

Oznaczenie	Numer produktu	DCON	BD	DCB	LPR	Waga
		mm Cal.	mm Cal.	mm Cal.	mm Cal.	kg lbs
SAH-2341112255	02836752	80,0 3.150	32,0 1.260	12,0 0.472	77,5 3.051	1,1 2.430
SAH-2341112259	02836757	100,0 3.937	32,0 1.260	12,0 0.472	90,0 3.543	1,9 4.190
SAH-2341116253	02836749	70,0 2.756	38,0 1.496	16,0 0.630	50,0 1.969	0,75 1.650
SAH-2341116256	02836754	80,0 3.150	38,0 1.496	16,0 0.630	82,5 3.248	1,2 2.650
SAH-2341120257	02836755	80,0 3.150	42,0 1.654	20,0 0.787	82,5 3.248	1,3 2.870
SAH-2341125258	02836756	80,0 3.150	50,0 1.969	25,0 0.984	90,0 3.543	1,7 3.750
SAH-2341125260	02836758	100,0 3.937	50,0 1.969	25,0 0.984	100,0 3.937	2,8 6.170
SAH-2341132261	02836759	100,0 3.937	60,0 2.362	32,0 1.260	103,0 4.055	2,9 6.390

Części zamienne, zawarte w dostawie

Dla DCON	Śruba regulacyjna
70	HCM6X16//ISO4028
80	HCM6X16//ISO4028
100	HCM8X12X1//ISO4028



Z uchwytem na tulejki zaciskowe ER

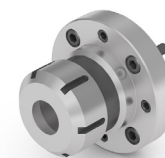
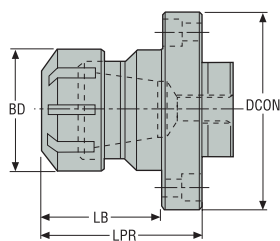

- Uwaga: Śruby regulacyjne zawarte w dostawie

Oznaczenie	Numer produktu	Wielkość	DCON	BD	LB	LPR	Waga
			mm <i>Cal.</i>	mm <i>Cal.</i>	mm <i>Cal.</i>	mm <i>Cal.</i>	kg <i>lbs</i>
SAH-23412ER25254	02836762	ER25	80,0 3.150	42,0 1.654	45,0 1.772	60,0 2.362	1,0 2.200
SAH-23412ER32255	02836763	ER32	80,0 3.150	50,0 1.969	45,0 1.772	60,0 2.362	1,2 2.650
SAH-23412ER40256	02836764	ER40	100,0 3.937	63,0 2.480	50,0 1.969	70,0 2.756	1,6 3.530

Części zamienne, zawarte w dostawie

Dla DCON	Śruba regulacyjna
80	HCM6X16/ISO4028
100	HCM8X12X1/ISO4028



Instrukcje dotyczące montażu

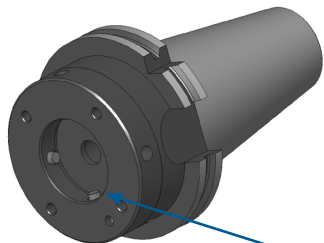

Śruby regulacji promieniowej

- Oczyszczyć powierzchnię kontaktową
- Upewnić się że śruby regulacji promieniowej nie przeszkodzą w montażu

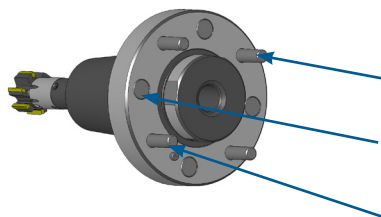

Śruby mocujące

Śruba regulacji kątowej

Kolek zabezpieczający (opcja)

- Upewnić się że śruby regulacji kątowej nie przeszkodzą w montażu

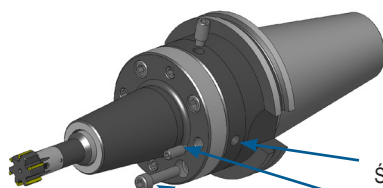

Śruby regulacji promieniowej (4 sztuki)

Śruby regulacji kątowej (4 sztuki)

Śruby mocujące (4 sztuki)

- Przejdź do montażu i ostrożnie dokręć śrubę mocującą (x4)

Instrukcje odnośnie regulacji

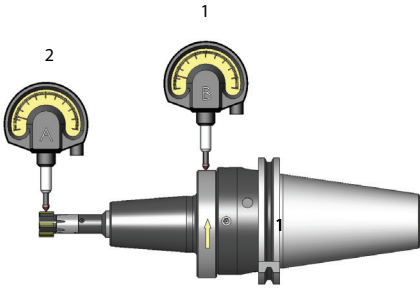
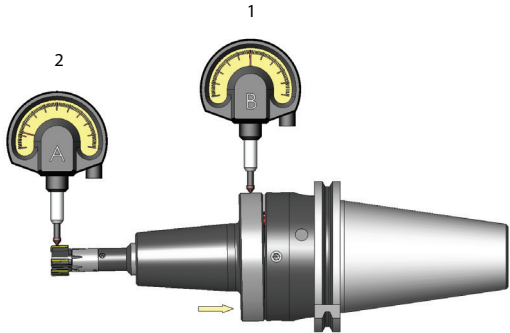
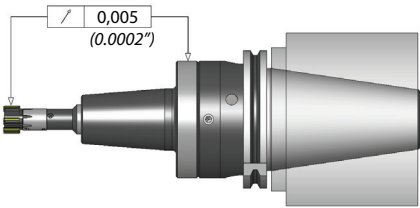
<ul style="list-style-type: none"> • Zamocować narzędzie we wrzecionie • Zamocuj czujnik 1 jak pokazano (czujnik 2 nie jest potrzebny na tym etapie) • Obracaj narzędzie ręką do uzyskania najniższego punktu • Wykonaj kompensację bicia jak pokazano strzałkami • Sprawdź i dokonaj ponownej regulacji gdy jest to konieczne 		Wstęp
<ul style="list-style-type: none"> • Zamocuj czujnik 2 jak pokazano • Obracaj narzędzie ręką do uzyskania najniższego punktu • Wykonaj kompensację bicia jak pokazano strzałkami • Sprawdź i dokonaj ponownej regulacji gdy jest to konieczne 		Wiercenie
<ul style="list-style-type: none"> • Po zakończonej regulacji, bicie $<5 \mu m$ ($197 \mu in$), należy dokończyć mocowanie, aby zabezpieczyć zespół • Regulowany adapter może być ustawiony wstępnie poza obrabiarką za pomocą dowolnego dostępnego urządzenia ustawczego • Ostateczna regulacja powinna zostać wykonana we wrzecionie obrabiarki • Należy użyć czujnika zegarowego. Do obu operacji można użyć jednego czujnika 		Rozwiercanie
		Wytłaczanie
		Załącznik

Przegląd asortymentu

Zaleca się stosowanie opravek wahlwvch Seco

- Gdy bicie przekracza 0,02 mm (0.0008")
- Dla narzędzi nieobrotowych

Kompaktowa seria GV dla dużych prędkości obrotowych

- Pierwszy wybór dla narzędzi obrotowych
- Nie wymaga ustawiania (ustawienie fabryczne)
- Obroty w zależności od zastosowania - maks. 3000 obr/min
- Odpowiednia dla zastosowań nieobrotowych



Seria kompaktowa

- Pierwszy wybór dla narzędzi nieobrotowych
- Regulacja wyłącznie promieniowa
- Do zastosowań obrotowych - maks. 800 obr/min.



Seria standardowa

- Stosowana gdy wymagana jest korekcja promieniowa i kątowa
- Do zastosowań obrotowych - maks. 800 obr/min.



Wszystkie oprawy wahlwe dla ch3odzenia przelotowego (wewnetrznego).
Dostępe 2 typy doprowadzania ch3odziwa.

JJL: doprowadzenie boczne.
JJ: doprowadzenie przez środek

Dostarczane z instrukcją użytkownika.

Kompaktowa seria GV dla dużych prędkości obrotowych

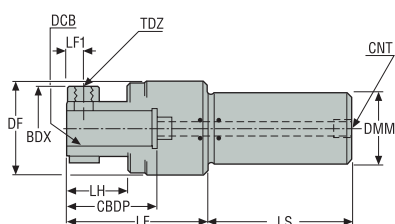

Numer produktu	Oznaczenie	DCB	DMM	LF	LS	DF	BDX	LH	CBDP	CNT	LF1	TDZ	ADJRG	Waga
		mm	mm	mm	mm	mm	mm	mm	mm		mm		mm	kg
00088959	SFH-GV11019JJ	10,0	19,05	47,5	40,0	33,0	30,0	11,5	25,0	1/8	5,5	M6	0,2	0,7
00088945	SFH-GV11020JJ	10,0	20,0	47,5	40,0	33,0	30,0	11,5	25,0	1/8	5,5	M6	0,2	0,8
00076815	SFH-GV21619JJ	16,0	19,05	66,0	50,0	49,5	39,0	24,5	40,0	1/8	8,0	M8	0,2	0,8
00072133	SFH-GV21620JJ	16,0	20,0	66,0	50,0	49,5	39,0	24,5	40,0	1/8	8,0	M8	0,2	0,8
00076827	SFH-GV22019JJ	20,0	19,05	76,0	50,0	49,5	45,0	34,5	50,0	1/8	8,0	M8	0,2	0,8
00072134	SFH-GV22020JJ	20,0	20,0	76,0	50,0	49,5	45,0	34,5	50,0	1/8	8,0	M8	0,2	0,8
00076828	SFH-GV32525JJ	25,0	25,4	89,0	60,0	62,0	52,0	43,5	60,0	1/4	11,0	M10	0,3	1,4
00072135	SFH-GV32525MJJ	25,0	25,0	89,0	60,0	62,0	52,0	43,5	60,0	1/4	11,0	M10	0,3	1,4
00088960	SFH-GV325425JJ	25,4	25,4	89,0	60,0	62,0	52,0	43,5	60,0	1/4	11,0	M10	0,3	1,4
02602671	SFH-GV43232JJ	32,0	32,0	90,0	80,0	72,0	60,0	34,0	60,0	3/8	9,0	M10	0,3	2,2

Akcesoria

Oznaczenie	Tulejka redukcyjna	
	DCB	DMM
SRR-BR11016	10	16
SRR-BR11216	12	16
SRR-BR11220	12	20
SRR-BR21620	16	20
SRR-BR31625	16	25
SRR-BR32025	20	25
SRR-GV42532	25	32

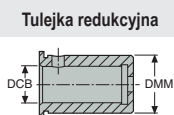

Kompaktowa seria GV dla dużych prędkości obrotowych z tulejką

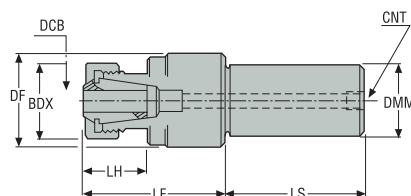

Numer produktu	Oznaczenie	CZC	DMM	LF	LS	DF	BDX	LH	CNT	ADJRG	Waga
			mm	mm	mm	mm	mm	mm		mm	kg
00088946	SFH-GV3BC25MJJ	ER32	25,0	80,0	60,0	62,0	50,0	35,0	-	0,3	1,3
00088961	SFH-GV3BC25JJ	ER32	25,4	80,0	60,0	62,0	50,0	35,0	-	0,3	1,3
00088962	SFH-GV4BC31JJ	ER40	31,75	94,0	80,0	72,0	63,0	39,0	-	0,3	0,7
00088947	SFH-GV4BC32JJ	ER40	32,0	94,0	80,0	72,0	63,0	39,0	-	0,3	2,4

Akcesoria

Oznaczenie	Wielkość	Tulejka*			Wielkość	Klucz*
		DCB	BD	OAL		
58803210	ER32	10	33	40	ER32	03B587532
58803212	ER32	12	33	40	-	-
58803213	ER32	13	33	40	-	-
58803216	ER32	16	33	40	-	-
58803220	ER32	20	33	40	-	-
58804016	ER40	16	41	46	ER40	03B537540
58804020	ER40	20	41	46	-	-
58804025	ER40	25	41	46	-	-
58804026	ER40	26	41	46	-	-

*Tuleja zaciskowa i klucze nie są dostarczane z oprawkami.

Wstęp

Wiercenie

Rozwiercanie

Wytaczanie

Załącznik

Seria kompaktowa

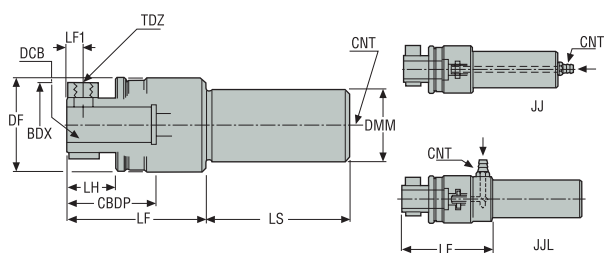

Numer produktu	Oznaczenie	DCB	DMM	LF	LS	DF	BDX	LH	CBBDP	CNT	LF1	TDZ	ADJRG	Waga
		mm	mm	mm	mm	mm	mm	mm	mm		mm	mm	mm	kg
00088963	SFH-C01019JJ	10,0	19,05	44,5	40,0	38,5	30,0	11,0	25,0	1/8	6,0	M6	1,0	0,575
00088964	SFH-C01019JJL	10,0	19,05	62,0	60,0	38,5	30,0	11,0	25,0	1/8	6,0	M6	1,0	0,575
00088965	SFH-C21619JJL	16,0	19,05	87,0	60,0	51,5	34,0	17,0	40,0	1/4	8,0	M6	1,5	1,1
00076829	SFH-C21619CJJ	16,0	19,05	67,5	50,0	51,5	34,0	17,0	40,0	1/4	8,0	M6	1,5	0,97
00088966	SFH-C22019JJL	20,0	19,05	97,0	70,0	51,5	44,0	27,0	50,0	1/4	8,0	M8	1,5	1,1
00076830	SFH-C22019CJJ	20,0	19,05	77,5	50,0	51,5	44,0	27,0	50,0	1/4	8,0	M8	1,5	0,97
00088948	SFH-C01020JJ	10,0	20,0	44,5	40,0	38,5	30,0	11,0	25,0	1/8	6,0	M6	1,0	0,59
00088949	SFH-C01020JJL	10,0	20,0	62,0	60,0	38,5	30,0	11,0	25,0	1/8	6,0	M6	1,0	0,59
00088950	SFH-C21620JJL	16,0	20,0	87,0	60,0	51,5	34,0	17,0	40,0	1/4	8,0	M6	1,5	1,1
00072142	SFH-C21620CJJ	16,0	20,0	67,5	50,0	51,5	34,0	17,0	40,0	1/4	8,0	M6	1,5	0,97
00072145	SFH-C22020CJJ	20,0	20,0	77,5	50,0	51,5	44,0	27,0	50,0	1/4	8,0	M8	1,5	1,0
00088951	SFH-C22020JJL	20,0	20,0	97,0	60,0	51,5	44,0	27,0	50,0	1/4	8,0	M8	1,5	1,1
00076846	SFH-C32525JJ	25,0	25,4	90,0	110,0	59,5	50,0	31,0	60,0	3/8	11,0	M8	1,5	1,7
00088967	SFH-C32525JJL	25,0	25,4	125,0	70,0	59,5	50,0	31,0	60,0	3/8	11,0	M8	1,5	1,98
00072149	SFH-C32525MJJ	25,0	25,0	90,0	110,0	59,5	50,0	31,0	60,0	3/8	11,0	M8	1,5	1,7
00088952	SFH-C32525MJL	25,0	25,0	125,0	70,0	59,5	50,0	31,0	60,0	3/8	11,0	M8	1,5	1,98

Akcesoria

Oznaczenie	Tulejka redukcyjna	
	DCB	DMM
SRR-BR11016	10	16
SRR-BR11216	12	16
SRR-BR11220	12	20
SRR-BR21620	16	20
SRR-BR31625	16	25
SRR-BR32025	20	25

Adapter przewodu elastycznego nie jest dołączony do zestawu.

Kompaktowa seria GV dla dużych prędkości obrotowych z tulejką

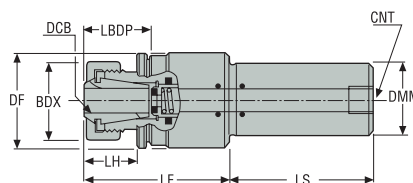

Numer produktu	Oznaczenie	CZC	DMM	LF	LS	DF	BDX	CBDP	LH	CNT	ADJRG	Waga
			mm	mm	mm	mm	mm	mm	mm		mm	kg
00088953	SFH-C65BC25MCJJ	ER32	25,0	94,0	50,0	64,5	50,0	42,0	33,0	3/8	1,5	1,7
00088968	SFH-C65BC25CJJ	ER32	25,4	94,0	50,0	64,5	50,0	42,0	33,0	3/8	1,5	1,7

Akcesoria

Oznaczenie	Wielkość	Tulejka*			Wielkość	Klucz*
		DCB	BD	OAL		
58803210	ER32	10	33	40	ER32	03B587532
58803212	ER32	12	33	40	-	-
58803213	ER32	13	33	40	-	-
58803216	ER32	16	33	40	-	-
58803220	ER32	20	33	40	-	-
58804016	ER40	16	41	46	ER40	03B537540
58804020	ER40	20	41	46	-	-
58804025	ER40	25	41	46	-	-
58804026	ER40	26	41	46	-	-

*Tuleja zaciskowa i klucze nie są dostarczane z oprawkami.

Seria standardowa

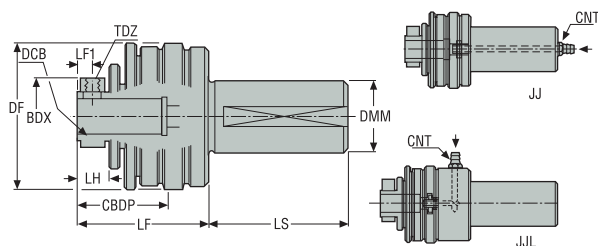

Numer produktu	Oznaczenie	DCB	DMM	LF	LS	DF	BDX	LH	CBDP	CNT	LF1	TDZ	ADJRG	ANADJ	Waga
		mm	mm	mm	mm	mm	mm	mm	mm		mm	mm	mm	mm	kg
00088969	SFH-11619JJ	16,0	19,05	64,0	50,0	62,0	34,0	16,0	40,0	1/4	8,0	M6	1,5	1,0 °	0,9
00088970	SFH-11619JJL	16,0	19,05	81,0	40,0	62,0	34,0	16,0	40,0	1/4	8,0	M6	1,5	1,0 °	1,32
00088954	SFH-11620JJ	16,0	20,0	64,0	50,0	62,0	34,0	16,0	40,0	1/4	8,0	M6	1,5	1,0 °	0,95
00088955	SFH-11620JJL	16,0	20,0	81,0	40,0	62,0	34,0	16,0	40,0	1/4	8,0	M6	1,5	1,0 °	1,34
00088971	SFH-22025JJ	20,0	25,4	74,0	65,0	82,0	44,0	16,0	50,0	3/8	8,0	M8	1,5	1,0 °	1,9
00088972	SFH-22025JJL	20,0	25,4	98,0	70,0	82,0	44,0	16,0	50,0	1/4	8,0	M8	1,5	1,0 °	2,2
00088956	SFH-22025MJJ	20,0	25,0	74,0	65,0	82,0	44,0	16,0	50,0	3/8	8,0	M8	1,5	1,0 °	1,9
00088957	SFH-22025MJJL	20,0	25,0	98,0	70,0	82,0	44,0	16,0	50,0	1/4	8,0	M8	1,5	1,0 °	2,2
00088973	SFH-32525JJ	25,0	25,4	82,5	110,0	91,0	52,0	22,0	60,0	3/8	11,0	M8	2,0	1,0 °	2,5
00088958	SFH-32525MJJ	25,0	25,0	82,5	110,0	91,0	52,0	22,0	60,0	3/8	11,0	M8	2,0	1,0 °	2,5

Akcesoria

Oznaczenie	Tulejka redukcyjna	
	DCB	DMM
SRR-BR11016	10	16
SRR-BR11216	12	16
SRR-BR11220	12	20
SRR-BR21620	16	20
SRR-BR31625	16	25
SRR-BR32025	20	25

Adapter przewodu elastycznego nie jest dołączony do zestawu.

Przyrząd do ustawiania — pojedynczy czujnik

SF-210340-C160: Numer produktu 02885391

- Stanowisko poziome
- Pierwszy wybór dla rozwiertaków Xfix
- 1 czujniki
- Maksymalne \varnothing narzędzia: 210 mm (8.268")
- Maksymalna długość narzędzia: 340 mm (13.386")
- Zawarte w dostawie: dodatkowe mocowanie \varnothing 57 mm (2.224") do HSK 63/80/100 i Capto C8 SSC5700, nr prod. 02208620

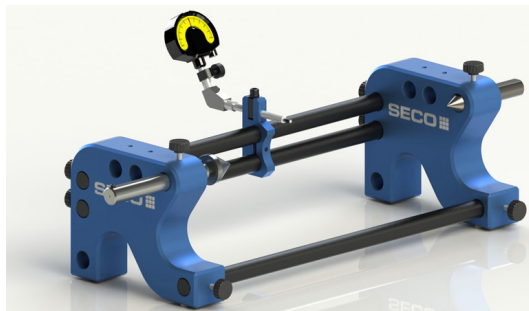

SF-210290V-C160: Numer produktu 02885392

- Stanowisko pionowe
- Pierwszy wybór dla rozwiertaków Xfix
- Maksymalne \varnothing narzędzia: 210 mm (8.268")
- Maksymalna długość narzędzia: 290 mm (11.417")
- Zawarte w dostawie: dodatkowe mocowanie \varnothing 57 mm (2.224") do HSK 63/80/100 i Capto C8 SSC5700, nr prod. 02208620

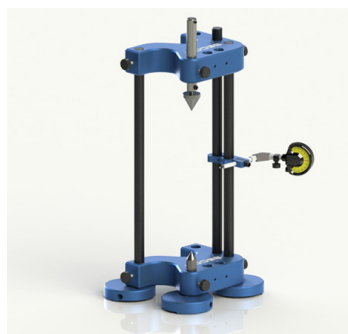

Przyrząd do ustawiania — podwójny czujnik

SF-210340-C160C190: Numer produktu 02885393

- Stanowisko poziome
- Pierwszy wybór dla rozwiertaków Bifix
- 2 czujniki
- Maksymalne \varnothing narzędzia: 210 mm (8.268")
- Maksymalna długość narzędzia: 340 mm (13.386")
- Zawarte w dostawie: dodatkowe mocowanie \varnothing 57 mm (2.224") do HSK 63/80/100 i Capto C8 SSC5700, nr prod. 02208620

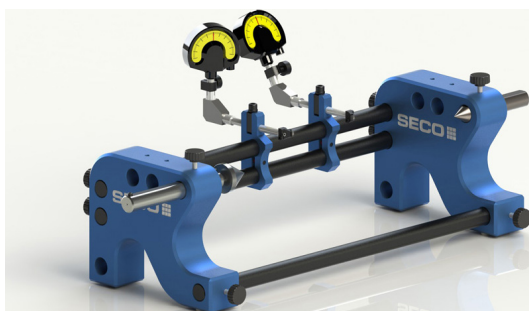

SF-210290V-C160C190: Numer produktu 02885394

- Stanowisko pionowe
- Pierwszy wybór dla rozwiertaków Bifix
- 2 czujniki
- Maksymalne \varnothing narzędzia: 210 mm (8.268")
- Maksymalna długość narzędzia: 290 mm (11.417")
- Zawarte w dostawie: dodatkowe mocowanie \varnothing 57 mm (2.224") do HSK 63/80/100 i Capto C8 SSC5700, nr prod. 02208620

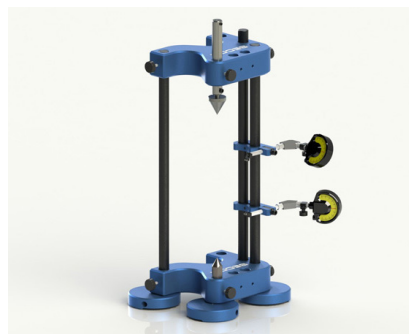

Aby uzyskać informacje dotyczące zamawiania, skontaktuj się z lokalnym przedstawicielem Seco Tools.

Przyrząd do ustawiania — pojedynczy czujnik o dużym zakresie

SF-210740-C160: Numer produktu 02885385

- Stanowisko poziome
- Pierwszy wybór dla rozwiertaków Xfix
- 1 czujnik
- Maksymalne \varnothing narzędzia: 210 mm (8.268")
- Maksymalna długość narzędzia: 740 mm (29.134")
- Zawarte w dostawie: dodatkowe mocowanie \varnothing 57 mm (2.224") do HSK 63/80/100 i Capto C8 SSC5700, nr prod. 02208620

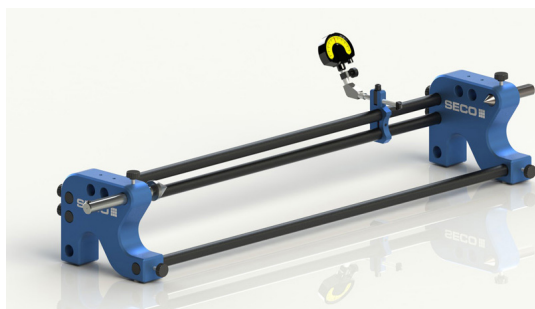
**SF-210690V-C160: Numer produktu 02885387**

- Stanowisko pionowe
- Pierwszy wybór dla rozwiertaków Xfix
- Maksymalne \varnothing narzędzia: 210 mm (8.268")
- Maksymalna długość narzędzia: 690 mm (27.165")
- Zawarte w dostawie: dodatkowe mocowanie \varnothing 57 mm (2.224") do HSK 63/80/100 i Capto C8 SSC5700, nr prod. 02208620



Przyrząd do ustawiania — podwójny czujnik o dużym zakresie

SF-210740-C160C190: Numer produktu 02885388

- Stanowisko poziome
- Pierwszy wybór dla rozwiertaków Bifix
- 2 czujniki
- Maksymalne \varnothing narzędzia: 210 mm (8.268")
- Maksymalna długość narzędzia: 740 mm (29.134")
- Zawarte w dostawie: dodatkowe mocowanie \varnothing 57 mm (2.224") do HSK 63/80/100 i Capto C8 SSC5700, nr prod. 02208620

**SF-210690V-C160C190: Numer produktu 02885390**

- Stanowisko pionowe
- Pierwszy wybór dla rozwiertaków Bifix
- 2 czujniki
- Maksymalne \varnothing narzędzia: 210 mm (8.268")
- Maksymalna długość narzędzia: 690 mm (27.165")
- Zawarte w dostawie: dodatkowe mocowanie \varnothing 57 mm (2.224") do HSK 63/80/100 i Capto C8 SSC5700, nr prod. 02208620



Aby uzyskać informacje dotyczące zamawiania, skontaktuj się z lokalnym przedstawicielem Seco Tools.

Przyrząd do ustawiania — kompaktowy

SF-60200-C160: Numer produktu 02885395

- Stanowisko poziome
- Pierwszy wybór dla \varnothing mniejsze niż 60 mm
- 1 czujniki
- Maksymalne \varnothing narzędzia: 60,5 mm (2.382")
- Maksymalna długość narzędzia: 200 mm (7.874")







SF-60200-C160C190: Numer produktu 02885396

- Stanowisko poziome
- Pierwszy wybór dla \varnothing mniejsze niż 60 mm (2.362")
- 2 czujniki
- Maksymalne \varnothing narzędzia: 60,5 mm (2.382")
- Maksymalna długość narzędzia: 200 mm (7.874")

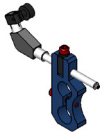

Aby uzyskać informacje dotyczące zamawiania, skontaktuj się z lokalnym przedstawicielem Seco Tools.

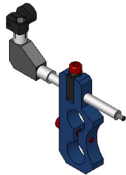
Dodatkowe ramię pomiarowe

	<p>SFB-60: Numer produktu 02208619</p> <ul style="list-style-type: none"> • Ramię pomiarowe 60° • Czujnik zawarty w dostawie • Końcówka pomiarowa nie zawarta w dostawie, patrz str. 490
	<p>SFB-60 WC: Numer produktu 02885754</p> <ul style="list-style-type: none"> • Ramię pomiarowe 60° • Czujnik nie zawarty w dostawie • Końcówka pomiarowa nie zawarta w dostawie, patrz str. 490
	<p>SFB-90: Numer produktu 02208622</p> <ul style="list-style-type: none"> • Ramię pomiarowe 90° • Czujnik zawarty w dostawie • Końcówka pomiarowa nie zawarta w dostawie, patrz str. 490
	<p>SFB-90 WC: Numer produktu 02885755</p> <ul style="list-style-type: none"> • Ramię pomiarowe 90° • Czujnik nie zawarty w dostawie • Końcówka pomiarowa nie zawarta w dostawie, patrz str. 490
	<p>DG-1: Numer produktu 75079579</p> <ul style="list-style-type: none"> • Czujnik zegarowy, 1 μm (39 μcal)

Przykład wieloczułnikowego przyrząd do ustawiania

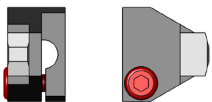
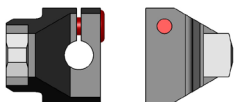
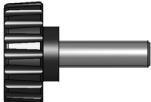
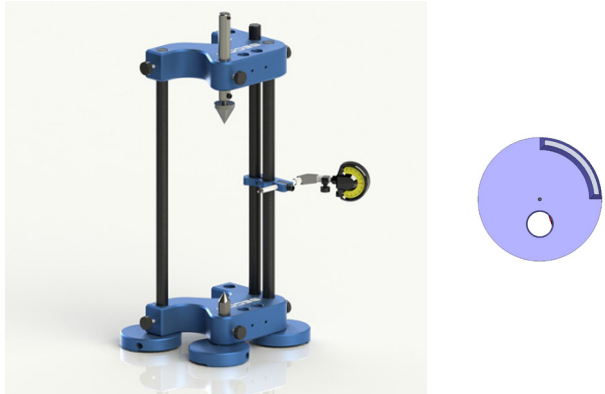

Akcesoria

	<p>SMES-406: Numer produktu 02819156</p> <ul style="list-style-type: none"> • Końcówka pomiarowa dla rozwiertaka Xfix • Ø 4mm (0.157") • Zakończenie węglikowe
	<p>SMES-900: Numer produktu 02208610</p> <ul style="list-style-type: none"> • Końcówka pomiarowa dla rozwiertaka Bifix • Zakończenie węglikowe
	<p>SMES-909: Numer produktu 02980090</p> <ul style="list-style-type: none"> • Końcówka pomiarowa do rozwiertaków Bifix • Zakończenie z węglika • Przesunięcie 9 mm (0.354")
	<p>SFHS-20: Numer produktu 02884025</p> <ul style="list-style-type: none"> • Ręczna śruba • Odpowiedni dla całego zakresu mocowania
	<p>SFVST-100: Numer produktu 02884026</p> <ul style="list-style-type: none"> • Stanowisko stalowe (3 zestawy) • Ø 100 mm (3.937") • Odpowiedni do zmiany położenia poziomego na pionowe

Wstęp

Wiercenie

Rozwiercanie

Wyłaczanie

Załącznik

Kły

<p>SFC-2000HM: Numer produktu 02884023</p> <ul style="list-style-type: none"> • Kieł węglkowy • Ø 20 mm (0.787") • Odpowiedni do rozwiertaków Xfix i Bifix, standardowych i specjalnych • Do stosowania na czole narzędzia 		Wstęp
<p>SSC-3400: Numer produktu 02208617</p> <ul style="list-style-type: none"> • Kieł sprężynujący • Ø 34 mm (1.339") • Odpowiedni do rozwiertaków Xfix i Bifix, standardowych i specjalnych • Do stosowania na chwycie narzędzia • Nie odpowiedni do HSK63/80/100 i capto C8 		Wiercenie
<p>SSC5700: Numer produktu 02208620</p> <ul style="list-style-type: none"> • Kieł sprężynujący • Obcięty Ø 57 mm (2.244") • Odpowiedni do rozwiertaków Xfix i Bifix, standardowych i specjalnych • Do stosowania na chwycie narzędzia • Odpowiedni do HSK63/80/100 i capto C8 		Rozwiercanie
		Wytaczanie
		Załącznik

Ogólny opis

Graflex® i Seco-Capto™

Oprawki, przedłużki i redukcje Graflex® i Seco-Capto™ do budowy wytaczaków



Str. - 494-553, 554

- Zespoły drążków wytaczających można szybko budować razem, zgodnie z najbliższymi wymaganymi potrzebami, za pomocą systemów modułowych Graflex lub Seco-Capto, w tym szerokiej gamy trzpieni i pośredników.
- Oba systemy oferują sztywne i precyzyjne połączenie do obróbki zgrubnej lub wykańczania otworów.
- Moduły mogą również otrzymać dużą liczbę opravek narzędziowych, takich jak tuleje zaciskowe, uchwyty hydrauliczne itp. (patrz Katalog systemów narzędziowych).

Główce do wytaczania RB750, obróbka zgrubna

Dwuostrzowe główce wytaczarskie, z mechanizmem sprzęgającym wkładki



Str. 566, 567-573

- Wysoka wydajność, precyzyjna geometria i położenie otworu
- Zarówno ustawienia symetryczne, jak i niesymetryczne
- Równoczesna regulacja przez mechanizm sprzęgający wkładek na płytce
- Z połączeniami Graflex® lub Seco-Capto™

Zakres średnic od 18 do 205 mm
(od 0.709 do 8.071")

IT 9/10

RB 610 główce do obróbki zgrubnej

Dwuostrzowe główce wytaczarskie



Str. 579-582

- Wysoka wydajność, precyzyjna geometria i położenie
- Zarówno ustawienia symetryczne, jak i niesymetryczne
- Z połączeniem Graflex® do systemu modułowego Graflex®
- Z połączeniem GL lub BA do opravek Steadyligne® z systemem tłumienia drgań

Zakres Ø od 28 mm do 116 mm
(od 1.102 do 4.567")

IT 9/10

Główce do wytaczania FB 760, typu Axiabore™, wytaczanie precyzyjne

Główce do dokładnego wytaczania, osiowe



Str. 590-601

- Regulacja mikrometryczna dla uzyskania dokładności otworu do IT5
- Wysoka sztywność dla dokładnej geometrii
- Główce Nanobore™ dla małych średnic
- Axialibrabore™ i - Axialibrabore™ Plus - z możliwością dokładnego wyważania, odpowiednie do HSM
- Adapter wielofunkcyjny (MPA) do wytaczania większych średnic, obtaczania oraz rowkowania
- Z połączeniami Graflex® lub Seco-Capto™

Zakres Ø od 0,3 do 108 mm
(od 0,012 do 4,252")

+ Toczenie średnic zewnętrznych i rowkowanie czołowe

IT 5/6

Ogólny opis

Głowice do wytaczania FB 620, FB 780 i FB 790, typ promieniowy

Głowice do dokładnego wytaczania promieniowe

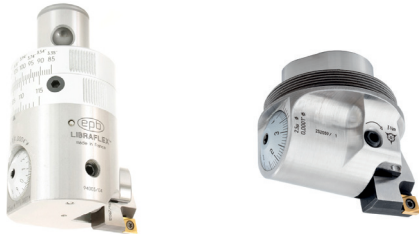

Str. 620, 621-629

- Regulacja mikrometryczna w celu uzyskania dokładności otworu do IT5
- Precyzyjna geometria i położenie otworu
- Głowice A790 Libraflex® z możliwością dokładnego wyważania, odpowiednie do obróbki HSM
- Długie otwory można wytaczać z wykorzystaniem przedłużeń z węgla (do 7xD) lub Steadyline® (do 10xD)
- Także do fazowania i wytaczania wstecznego
- Z połączeniem Graflex® lub Seco-Capto™ do systemów modułowych
- Z połączeniem GL lub BA do opravek tłumiących drgania Steadyline®

Zakres średnic od Ø 15 do 205 mm
(od 0,591 do 8,071")

IT 5/6

Głowice dla belek stand. i Jumbo

Do dużych średnic przy wytaczaniu zgrubnym i dokładnym



Str. 631-648

- Bloki dostępne do operacji wytaczania zgrubnego i na gotowo, obtaczania i wytaczania wstecznego
- Mocna konstrukcja zapewniająca wysoką wydajność przy zgrubnym wytaczaniu
- Mikrometryczna regulacja do dokładnego wytaczania
- Optymalna konstrukcja bloków oraz belek Jumbo wykonane z aluminium o dużej wytrzymałości
- Może być mocowane na oprawce frezarskiej, z mocowaniem kołnierзовym

Zakres Ø 204 do 3205 mm
(8.031-126.181")IT 5/6 (na gotowo) lub 9/10
(zgrubnie)
+ obtaczanie IT6

IT6

Płytki do wytaczania



Str. 650-662

- Do operacji wytaczania we wszystkich materiałach
- Duża ciągliwość do zgrubnego wytaczania
- Geometrie dodatnie do dokładnego wytaczania
- Gatunki dobrane dla zapewnienia dużej trwałości

Systemy modułowe Graflex® lub Seco-Capto™



Str. 663-665

- Wszystkie głowice do wytaczania mają połączenie Graflex® lub Seco-Capto™ umożliwiające zastosowanie pełnego zakresu głębokości wytaczania i średnic
- Istnieje możliwość doboru odpowiednich opravek i elementów pośrednich Graflex® lub Seco-Capto™ z katalogu opravek narzędziowych (HSK, DIN, BT, ANSI-CAT, Seco-Capto™)
- Części zamienne do połączeń głowic do wytaczania Graflex® zostały przedstawione w tym rozdziale



Graflex®

Zestawy Graflex® obejmują oprawki, elementy pośrednie, oprawki narzędziowe i głowice do wytaczania, które w razie potrzeby można szybko połączyć ze sobą. Moduły Graflex®, odpowiednie do operacji frezowania, wiercenia, gwintowania, rozwiercania oraz wytaczania, umożliwiają obsługę narzędzi o różnych długościach i średnicach. Można je zamontować we wszystkich typach obrabiarek, zastępując podstawową oprawkę Graflex®.

- Doskonała sztywność połączenia
- Szeroka gama modułów zapewniająca znaczną uniwersalność
- Możliwość doprowadzania chłodziwa

Graflex®, wymiary połączenia

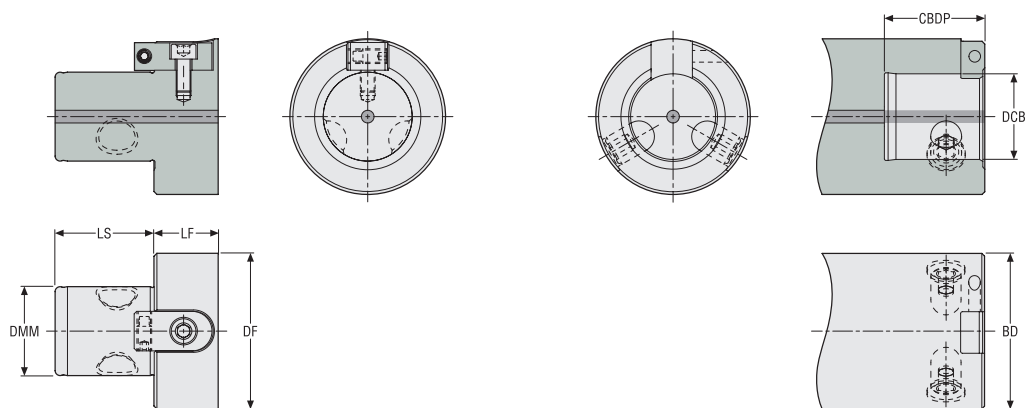

Oznaczenie katalogowe Strona wrzeciona	Pogłębienie dla RFID*	DF	DMM	LS	LF
		mm Cal.	mm Cal.	mm Cal.	mm Cal.
G0	Nie	16 0.630	8 0.315	12 0.472	8 0.315
G1	Nie	20 0.787	11 0.433	13 0.512	9,5 0.374
G2	Nie	25 0.984	14 0.551	16 0.630	11 0.433
G3	Nie	32 1.260	18 0.709	20 0.787	14 0.551
G4	Nie	40 1.575	22 0.866	24 0.945	17 0.669
G5	Nie	50 1.969	28 1.102	30 1.181	20 0.787
G6	Nie	63 2.480	36 1.417	40 1.575	26 1.024
G7	Nie	90 3.543	46 1.811	50 1.969	26 1.024

Oznaczenie katalogowe Strona wrzeciona	Pogłębienie dla RFID*	CBDP	DCB	BD
		mm Cal.	mm Cal.	mm Cal.
G0	Nie	16 0.630	8 0.315	12 0.472
G1	Nie	20 0.787	11 0.433	13 0.512
G2	Nie	25 0.984	14 0.551	16 0.630
G3	Nie	32 1.260	18 0.709	20 0.787
G4	Nie	40 1.575	22 0.866	24 0.945
G5	Nie	50 1.969	28 1.102	30 1.181
G6	Nie	63 2.480	36 1.417	40 1.575
G7	Nie	90 3.543	46 1.811	50 1.969

Uwaga: Następujące wymiary według norm są stosowane do wszystkich opravek pokazanych na stronach produktów.

* Brak pogłębienia pod RFID

G 401 – Oprawki Graflex®

HSK-A/ ISO12164-1-HSK-A

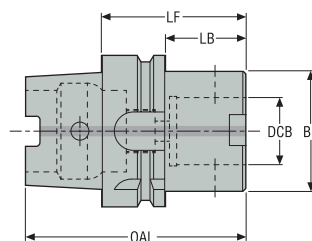

- Zaślepki uszczelniające, przewody do chłodziwa oraz klucze do przewodów dla HSK, patrz str. 523

Oznaczenie	Numer produktu	CTMS	CTWS	DCB	LF	LB	BD	OAL	RFID otwór	Wyważenie	Waga
				mm Cal.	mm Cal.	mm Cal.	mm Cal.	mm Cal.			kg lbs
EM93034012870	00086917	HSK-A50	G5	28,0 1.102	70,0 2.756	44,0 1.732	50,0 1.969	95,0 3.740	1	PB	0,79 1.740
EM93044011445	02469722	HSK-A63	G2	14,0 0.551	45,0 1.772	19,0 0.748	25,0 0.984	77,0 3.031	1	G6.3	0,69 1.520
EM93044011850	00086918	HSK-A63	G3	18,0 0.709	50,0 1.969	24,0 0.945	32,0 1.260	82,0 3.228	1	G6.3	0,73 1.610
EM93044012255	00088217	HSK-A63	G4	22,0 0.866	55,0 2.165	29,0 1.142	40,0 1.575	87,0 3.425	1	G6.3	0,83 1.830
EM93044012860	00086920	HSK-A63	G5	28,0 1.102	60,0 2.362	34,0 1.339	50,0 1.969	92,0 3.622	1	PB	0,98 2.160
EM930440128100	00086921	HSK-A63	G5	28,0 1.102	100,0 3.937	74,0 2.913	50,0 1.969	132,0 5.197	1	PB	1,58 3.480
EM930440128140	00086922	HSK-A63	G5	28,0 1.102	140,0 5.512	114,0 4.488	50,0 1.969	172,0 6.772	1	PB	2,18 4.810
EM93044013670	00086923	HSK-A63	G6	36,0 1.417	70,0 2.756	44,0 1.732	63,0 2.480	102,0 4.016	1	PB	1,21 2.670
EM930440136120	00086924	HSK-A63	G6	36,0 1.417	120,0 4.724	94,0 3.701	63,0 2.480	152,0 5.984	1	PB	2,38 5.250
EM93064011855	00086925	HSK-A100	G3	18,0 0.709	55,0 2.165	26,0 1.024	32,0 1.260	105,0 4.134	1	G6.3	2,1 4.630
EM93064012260	00086926	HSK-A100	G4	22,0 0.866	60,0 2.362	31,0 1.220	40,0 1.575	110,0 4.331	1	G6.3	2,19 4.830
EM93064012865	00086927	HSK-A100	G5	28,0 1.102	65,0 2.559	36,0 1.417	50,0 1.969	115,0 4.528	1	PB	2,37 5.220
EM930640128110	00086928	HSK-A100	G5	28,0 1.102	110,0 4.331	81,0 3.189	50,0 1.969	160,0 6.299	1	PB	3,02 6.660
EM930640128150	00086929	HSK-A100	G5	28,0 1.102	150,0 5.906	121,0 4.764	50,0 1.969	200,0 7.874	1	PB	3,7 8.160
EM93064013675	00083432	HSK-A100	G6	36,0 1.417	75,0 2.953	46,0 1.811	63,0 2.480	125,0 4.921	1	PB	2,6 5.730
EM930640136120	00086931	HSK-A100	G6	36,0 1.417	120,0 4.724	91,0 3.583	63,0 2.480	170,0 6.693	1	PB	3,82 8.420
EM930640136160	00086932	HSK-A100	G6	36,0 1.417	160,0 6.299	131,0 5.157	63,0 2.480	210,0 8.268	1	PB	4,72 10.410
EM93064014685	00074385	HSK-A100	G7	46,0 1.811	85,0 3.346	56,0 2.205	90,0 3.543	135,0 5.315	1	PB	3,99 8.800
EM930640146160	00086933	HSK-A100	G7	46,0 1.811	160,0 6.299	131,0 5.157	90,0 3.543	210,0 8.268	1	PB	7,67 16.910
HSKA125-G6-120	03229653	HSK-A125	G6	36,0 1.417	120,0 4.724	91,0 3.583	63,0 2.480	183,0 7.205	1	PB	5,1 11.240
HSKA125-G7-120	03229654	HSK-A125	G7	46,0 1.811	120,0 4.724	91,0 3.583	90,0 3.543	183,0 7.205	1	PB	7,1 15.650

Części zamienne, zawarte w dostawie

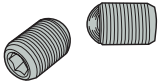
Dla wielkości	Śruba mocująca
	
G2	90F2
G3	90F3
G4	90F4
G5	90F5
G6	90F6
G7	90F7

Akcesoria

Dla wielkości	Klucz mocujący
	
G2	03H025
G3	03H03
G4	03H04
G5	03H05
G6	03H06
G7	03H10

G 401 – Oprapki Graflex®

SA/SK/DIN 69871-ADB



Wersja 1

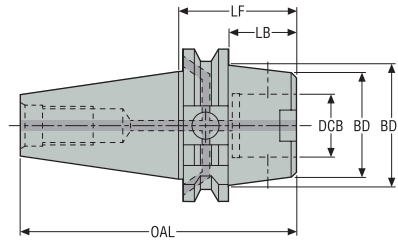

Wersja 2

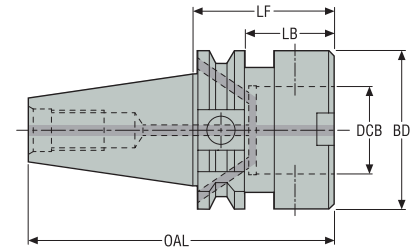

Oznaczenie	Numer produktu	CTMS	CTWS	DCB	LF	LB	BD1	OAL	Wersja	RFID otwór	Wyważenie	Waga
				mm Cal.	mm Cal.	mm Cal.	mm Cal.	mm Cal.				kg lbs
EM34694011190	02503292	DIN40 ADB	G1	11,0 0.433	90,0 3.543	70,9 2.791	-	158,4 6.236	2	1	G6.3	0,94 2.070
EM34694011435	02469729	DIN40 ADB	G2	14,0 0.551	35,0 1.378	15,9 0.626	-	103,4 4.071	2	1	G6.3	0,83 1.830
EM34694011490	02503293	DIN40 ADB	G2	14,0 0.551	90,0 3.543	70,9 2.791	-	158,4 6.236	2	1	G6.3	1,02 2.250
EM34694011835	02420097	DIN40 ADB	G3	18,0 0.709	35,0 1.378	15,9 0.626	50,0 1.969	103,4 4.071	1	1	G6.3	0,91 2.010
EM346940118100	02503298	DIN40 ADB	G3	18,0 0.709	100,0 3.937	80,9 3.185	-	168,4 6.630	2	1	G6.3	1,22 2.690
EM34694012235	02503299	DIN40 ADB	G4	22,0 0.866	35,0 1.378	15,9 0.626	50,0 1.969	103,4 4.071	1	1	G6.3	0,92 2.030
EM346940122100	02503300	DIN40 ADB	G4	22,0 0.866	100,0 3.937	80,9 3.185	-	168,4 6.630	2	1	G6.3	1,44 3.170
EM34694012840	02458421	DIN40 ADB	G5	28,0 1.102	40,0 1.575	20,9 0.823	-	108,4 4.268	2	1	PB	0,93 2.050
EM34694012880	02503301	DIN40 ADB	G5	28,0 1.102	80,0 3.150	60,9 2.398	-	148,4 5.843	2	1	PB	1,5 3.310
EM346940128120	02503302	DIN40 ADB	G5	28,0 1.102	120,0 4.724	100,9 3.972	-	188,4 7.417	2	1	PB	2,08 4.590
EM34694013660	02503303	DIN40 ADB	G6	36,0 1.417	60,0 2.362	40,9 1.610	-	128,4 5.055	2	1	PB	1,24 2.730
EM346940136120	02503304	DIN40 ADB	G6	36,0 1.417	120,0 4.724	100,9 3.972	-	188,4 7.417	2	1	PB	2,65 5.840
EM347140114100	02503306	DIN50 ADB	G2	14,0 0.551	100,0 3.937	80,9 3.185	-	201,7 7.941	2	1	G6.3	2,8 6.170
EM34714011835	02503307	DIN50 ADB	G3	18,0 0.709	35,0 1.378	15,9 0.626	-	136,7 5.382	2	1	G6.3	2,67 5.890
EM347140118110	02503308	DIN50 ADB	G3	18,0 0.709	110,0 4.331	90,9 3.579	-	211,7 8.335	2	1	G6.3	3,0 6.610
EM34714012235	02503309	DIN50 ADB	G4	22,0 0.866	35,0 1.378	15,9 0.626	80,0 3.150	136,7 5.382	1	1	G6.3	2,88 6.350
EM347140122120	02503311	DIN50 ADB	G4	22,0 0.866	120,0 4.724	100,9 3.972	-	221,7 8.728	2	1	G6.3	3,5 7.720
EM34714012840	02503312	DIN50 ADB	G5	28,0 1.102	40,0 1.575	20,9 0.823	-	141,7 5.579	2	1	PB	2,75 6.060
EM347140128100	02503315	DIN50 ADB	G5	28,0 1.102	100,0 3.937	80,9 3.185	-	201,7 7.941	2	1	PB	3,56 7.850
EM347140128140	02503316	DIN50 ADB	G5	28,0 1.102	140,0 5.512	120,9 4.760	-	241,7 9.516	2	1	PB	4,08 8.990
EM34714013645	02503317	DIN50 ADB	G6	36,0 1.417	45,0 1.772	25,9 1.020	-	146,7 5.776	2	1	PB	2,88 6.350
EM347140136100	02503318	DIN50 ADB	G6	36,0 1.417	100,0 3.937	80,9 3.185	-	201,7 7.941	2	1	PB	4,1 9.040
EM347140136140	02503319	DIN50 ADB	G6	36,0 1.417	140,0 5.512	120,9 4.760	-	241,7 9.516	2	1	PB	4,99 11.000

Wstęp

Wiercenie

Rozwiercanie

Wytaczanie

Załącznik

Oznaczenie	Numer produktu	CTMS	CTWS	DCB	LF	LB	BD1	OAL	Wersja	RFID otwór	Wyważenie	Waga
				mm Cal.	mm Cal.	mm Cal.	mm Cal.	mm Cal.				kg lbs
EM34714014650	02503320	DIN50 ADB	G7	46,0 1.811	50,0 1.969	30,9 1.217	–	151,7 5.972	2	1	PB	3,23 7.120
EM347140146120	02503321	DIN50 ADB	G7	46,0 1.811	120,0 4.724	100,9 3.972	–	221,7 8.728	2	1	PB	6,48 14.290
EM347140146200	02503324	DIN50 ADB	G7	46,0 1.811	200,0 7.874	180,9 7.122	–	301,7 11.878	2	1	PB	10,4 22.930

Akcesoria

Dla wielkości	Klucz mocujący
	
DIN40/ G1	03H02
DIN40/ G2	03H025
DIN40/ G3	03H03
DIN40/ G4	03H04
DIN40/ G5	03H05
DIN40/ G6	03H06
DIN50/ G2	03H025
DIN50/ G3	03H03
DIN50/ G4	03H04
DIN50/ G5	03H05
DIN50/ G6	03H06
EM34714014650	03H10
DIN50/ G7	03H10

Części zamienne, zawarte w dostawie

Dla wielkości	Śruba mocująca	Śruba uszczelniająca
		
DIN40/ G1	90F1	950A0406
DIN40/ G2	90F2	950A0406
DIN40/ G3	90F3	950A0406
DIN40/ G4	90F4	950A0406
DIN40/ G5	90F5	950A0406
DIN40/ G6	90F6	950A0406
DIN50/ G2	90F2	950A0606
DIN50/ G3	90F3	950A0606
DIN50/ G4	90F4	950A0606
DIN50/ G5	90F5	950A0606
DIN50/ G6	90F6	950A0606
DIN50/ G7	90F7	950A0606
EM34714014650	90F71	950A0606

G 401 – Oprapki Graflex®

DIN 2080



Wersja 1

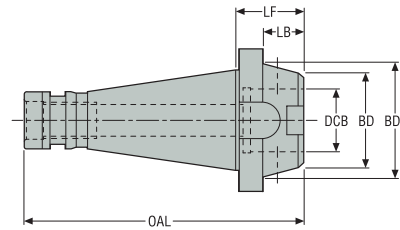

Wersja 2

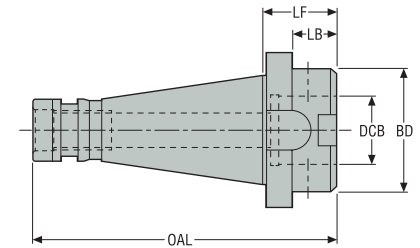

Oznaczenie	Numer produktu	CTMS	CTWS	DCB	LF	LB	BD1	BD	OAL	Wersja	RFID otwór	Wyważenie	Waga
				mm Cal.	mm Cal.	mm Cal.	mm Cal.	mm Cal.	mm Cal.				kg lbs
EM00404013650	00076707	DIN(2080)40	G6	36,0 1.417	50,0 1.969	0,0 -	-	63,0 2.480	143,4 5.646	2	0	PB	1,27 2.800
EM00504012835	00076710	DIN(2080)50	G5	28,0 1.102	35,0 1.378	19,8 0.780	78,0 3.071	50,0 1.969	161,8 6.370	1	0	PB	2,94 6.480
EM00504013640	00076714	DIN(2080)50	G6	36,0 1.417	40,0 1.575	24,8 0.976	-	63,0 2.480	166,8 6.567	2	0	PB	2,82 6.220
EM00504014645	00076718	DIN(2080)50	G7	46,0 1.811	45,0 1.772	29,8 1.173	-	90,0 3.543	171,8 6.764	2	0	PB	3,34 7.360

Akcesoria

Dla wielkości	Klucz mocujący
G6	03H06
G5	03H05
G7	03H10

Części zamienne, zawarte w dostawie

Dla wielkości	Śruba mocująca
G5	90F5
G6	90F6
G7	90F7

Wstęp

Wiercenie

Rozwiercanie

Wytaczanie

Załącznik

G 401 – Oprawki Graflex®

BT JIS B 6339-AD

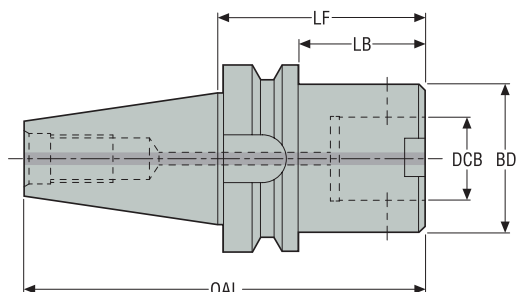

Oznaczenie	Numer produktu	CTMS	CTWS	DCB	LF	LB	BD	OAL	RFID otwór	Wyważenie	Waga
				mm Cal.	mm Cal.	mm Cal.	mm Cal.	mm Cal.			kg lbs
EM40404011835	00056699	BT30 AD	G3	18,0 0.709	35,0 1.378	13,0 0.512	32,0 1.260	83,4 3.283	0	G6.3	0,41 0.900
EM40404012850	00056705	BT30 AD	G5	28,0 1.102	50,0 1.969	25,0 0.984	50,0 1.969	98,4 3.874	0	PB	0,62 1.370

Akcesoria

Dla wielkości

Klucz mocujący



EM40404011835

03H03

EM40404012850

03H05

Części zamienne, zawarte w dostawie

Dla wielkości

Śruba mocująca

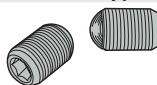

EM40404011835

90F3

EM40404012850

90F5

Wstęp

Wiercenie

Rozwiercanie

Wytaczanie

Załącznik

G 401 – Oprapki Graflex®

BT JIS B 6339-ADB



Wersja 1

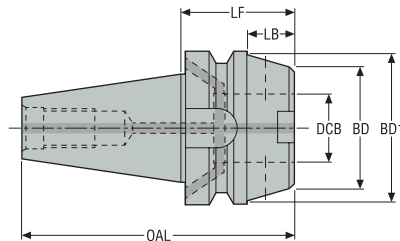

Wersja 2

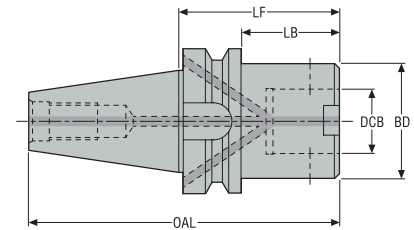

Oznaczenie	Numer produktu	CTMS	CTWS	DCB	LF	LB	BD1	BD	OAL	Wersja	RFID otwór	Wyważenie	Waga
				mm Cal.	mm Cal.	mm Cal.	mm Cal.	mm Cal.	mm Cal.				kg lbs
EM34144011190	02503364	BT40 ADB	G1	11,0 0.433	90,0 3.543	63,0 2.480	–	20,0 0.787	155,4 6.118	2	1	G6.3	1,06 2.340
EM34144011440	02469725	BT40 ADB	G2	14,0 0.551	40,0 1.575	13,0 0.512	–	25,0 0.984	105,4 4.150	2	1	G6.3	0,98 2.160
EM34144011490	02503365	BT40 ADB	G2	14,0 0.551	90,0 3.543	63,0 2.480	–	25,0 0.984	155,4 6.118	2	1	G6.3	1,15 2.540
EM34144011840	02503366	BT40 ADB	G3	18,0 0.709	40,0 1.575	13,0 0.512	62,0 2.441	32,0 1.260	105,4 4.150	1	1	G6.3	1,07 2.360
EM341440118100	02503367	BT40 ADB	G3	18,0 0.709	100,0 3.937	73,0 2.874	–	32,0 1.260	165,4 6.512	2	1	G6.3	1,31 2.890
EM34144012245	02503368	BT40 ADB	G4	22,0 0.866	45,0 1.772	18,0 0.709	62,0 2.441	40,0 1.575	110,4 4.346	1	1	G6.3	1,14 2.510
EM341440122100	02503370	BT40 ADB	G4	22,0 0.866	100,0 3.937	73,0 2.874	–	40,0 1.575	165,4 6.512	2	1	G6.3	1,54 3.400
EM34144012845	02457989	BT40 ADB	G5	28,0 1.102	45,0 1.772	18,0 0.709	62,0 2.441	50,0 1.969	110,4 4.346	1	1	PB	1,12 2.470
EM34144012880	02503371	BT40 ADB	G5	28,0 1.102	80,0 3.150	53,0 2.087	–	50,0 1.969	145,4 5.724	2	1	PB	1,54 3.400
EM341440128120	02503372	BT40 ADB	G5	28,0 1.102	120,0 4.724	93,0 3.661	–	50,0 1.969	185,4 7.299	2	1	PB	2,12 4.670
EM34144013650	02503373	BT40 ADB	G6	36,0 1.417	50,0 1.969	0,0 –	–	63,0 2.480	115,4 4.543	2	0	PB	1,13 2.490
EM341440136120	02503374	BT40 ADB	G6	36,0 1.417	120,0 4.724	0,0 –	–	63,0 2.480	185,4 7.299	2	1	PB	2,78 6.130
EM341640114110	02503375	BT50 ADB	G2	14,0 0.551	110,0 4.331	72,0 2.835	–	25,0 0.984	211,8 8.339	2	1	G6.3	3,7 8.160
EM34164011845	02503376	BT50 ADB	G3	18,0 0.709	45,0 1.772	7,0 0.276	70,0 2.756	32,0 1.260	146,8 5.780	1	1	G6.3	3,58 7.890
EM341640118120	02503377	BT50 ADB	G3	18,0 0.709	120,0 4.724	82,0 3.228	–	32,0 1.260	221,8 8.732	2	1	G6.3	3,9 8.600
EM34164012250	02503378	BT50 ADB	G4	22,0 0.866	50,0 1.969	12,0 0.472	70,0 2.756	40,0 1.575	151,8 5.976	1	1	G6.3	3,66 8.070
EM341640122140	02503379	BT50 ADB	G4	22,0 0.866	140,0 5.512	102,0 4.016	–	40,0 1.575	241,8 9.520	2	1	G6.3	4,5 9.920
EM34164012855	02503380	BT50 ADB	G5	28,0 1.102	55,0 2.165	17,0 0.669	98,0 3.858	50,0 1.969	156,8 6.173	1	1	PB	4,0 8.820
EM341640128100	02503381	BT50 ADB	G5	28,0 1.102	100,0 3.937	62,0 2.441	–	50,0 1.969	201,8 7.945	2	1	PB	4,22 9.300
EM341640128140	02503382	BT50 ADB	G5	28,0 1.102	140,0 5.512	102,0 4.016	–	50,0 1.969	241,8 9.520	2	1	PB	4,8 10.580
EM34164013663	02503383	BT50 ADB	G6	36,0 1.417	63,0 2.480	25,0 0.984	98,0 3.858	63,0 2.480	164,8 6.488	1	1	PB	4,2 9.260
EM341640136100	02503384	BT50 ADB	G6	36,0 1.417	100,0 3.937	62,0 2.441	–	63,0 2.480	201,8 7.945	2	1	PB	4,6 10.140
EM341640136140	02503385	BT50 ADB	G6	36,0 1.417	140,0 5.512	102,0 4.016	–	63,0 2.480	241,8 9.520	2	1	PB	5,54 12.210

Wstęp

Wiercenie

Rozwiercanie

Wytaczanie



Załącznik

Oznaczenie	Numer produktu	CTMS	CTWS	DCB	LF	LB	BD1	BD	OAL	Wersja	RFID otwór	Wyważenie	Waga
				mm Cal.	mm Cal.	mm Cal.	mm Cal.	mm Cal.	mm Cal.				kg lbs
EM34164014665	02503386	BT50 ADB	G7	46,0 1.811	65,0 2.559	27,0 1.063	98,0 3.858	90,0 3.543	166,8 6.567	1	1	PB	4,4 9.700
EM341640146120	02503387	BT50 ADB	G7	46,0 1.811	120,0 4.724	82,0 3.228	-	90,0 3.543	221,8 8.732	2	1	PB	6,8 14.990
EM341640146200	02503388	BT50 ADB	G7	46,0 1.811	200,0 7.874	162,0 6.378	-	90,0 3.543	301,8 11.882	2	1	PB	10,7 23.590

Akcesoria

Dla wielkości	Klucz mocujący
	
BT40/ G1	03H02
BT40/ G2	03H025
BT40/ G3	03H03
BT40/ G4	03H04
BT40/ G5	03H05
BT40/ G6	03H06
BT50/ G2	03H025
BT50/ G3	03H03
BT50/ G4	03H04
BT50/ G5	03H05
BT50/ G6	03H06
BT50/ G7	03H10

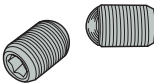
Części zamienne, zawarte w dostawie

Dla wielkości	Śruba mocująca	Śruba uszczelniająca
		
BT40/ G1	90F1	950A0406
BT40/ G2	90F2	950A0406
BT40/ G3	90F3	950A0406
BT40/ G4	90F4	950A0406
BT40/ G5	90F5	950A0406
BT40/ G6	90F6	950A0406
BT50/ G2	90F2	950A0606
BT50/ G3	90F3	950A0606
BT50/ G4	90F4	950A0606
BT50/ G5	90F5	950A0606
BT50/ G6	90F6	950A0606
BT50/ G7	90F7	950A0606

G 401 – Oprawki Graflex®

Oprawki BT stożek-czoło-AD/ADB



Wersja 1

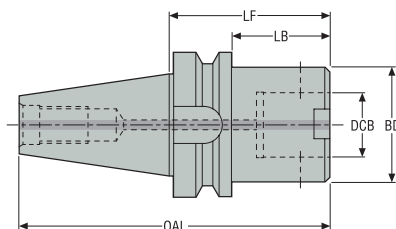

Wersja 2

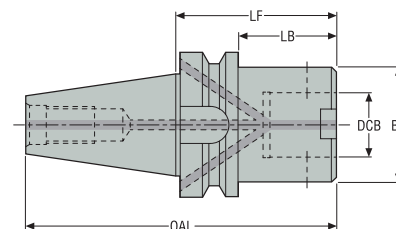

Oznaczenie	Numer produktu	CTMS	CTWS	DCB	LF	LB	BD	OAL	Wersja	RFID otwór	Wyważenie	Waga
				mm Cal.	mm Cal.	mm Cal.	mm Cal.	mm Cal.				kg lbs
EM40024011850	02998757	BT30 TF AD	G3	18,0 0.709	50,0 1.969	28,0 1.102	32,0 1.260	98,4 3.874	1	0	G6.3	0,5 1.100
EM40024012250	02998758	BT30 TF AD	G4	22,0 0.866	50,0 1.969	28,0 1.102	40,0 1.575	98,4 3.874	1	0	G6.3	0,6 1.320
EM321440122100	02998754	BT40 TF ADB	G4	22,0 0.866	100,0 3.937	73,0 2.874	40,0 1.575	165,4 6.512	2	1	G6.3	1,6 3.530
EM321440128120	02926006	BT40 TF ADB	G5	28,0 1.102	120,0 4.724	93,0 3.661	50,0 1.969	185,4 7.299	2	1	PB	2,1 4.630
EM321440136120	02998755	BT40 TF ADB	G6	36,0 1.417	120,0 4.724	93,0 3.661	63,0 2.480	185,4 7.299	2	1	PB	2,8 6.170
EM321640128140	02998756	BT50 TF ADB	G5	28,0 1.102	140,0 5.512	102,0 4.016	50,0 1.969	241,8 9.520	2	1	PB	4,9 10.800
EM321640136140	02926009	BT50 TF ADB	G6	36,0 1.417	140,0 5.512	102,0 4.016	63,0 2.480	241,8 9.520	2	1	PB	5,6 12.350
EM321640146200	02926010	BT50 TF ADB	G7	46,0 1.811	200,0 7.874	162,0 6.378	90,0 3.543	301,8 11.882	2	1	PB	10,7 23.590



Akcesoria

Dla	Klucz mocujący
EM40024011850	03H03
EM40024012250	03H04
EM321440122100	03H04
EM321440128120	03H05
EM321440136120	03H06
EM321640128140	03H05
EM321640136140	03H06
EM321640146200	03H10

Klucz mocujący

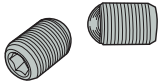

Części zamienne, zawarte w dostawie

Dla	Śruba mocująca	Śruba uszczelniająca
		
EM40024011850	90F3	-
EM40024012250	90F4	-
EM321440122100	90F4	950A0406
EM321440128120	90F5	950A0406
EM321440136120	90F6	950A0406
EM321640128140	90F5	950A0606
EM321640136140	90F6	950A0606
EM321640146200	90F7	950A0606

Wstęp

Wiercenie

Rozwiercanie

Wytaczanie

Załącznik

G 401 – Oprapki Graflex®

CAT / ASME B5.50-1994-ADB



Wersja 1

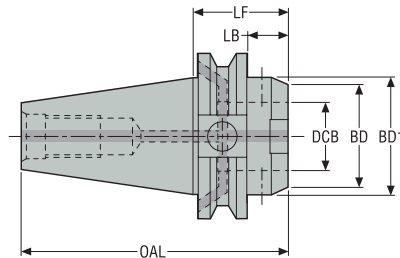

Wersja 2

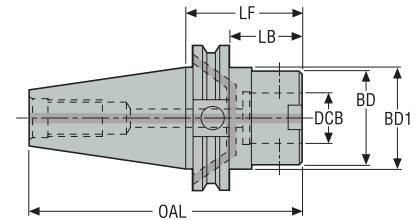

Oznaczenie	Numer produktu	CTMS	CTWS	DCB	LF	LB	BD1	BD	OAL	Wersja	RFID otwór	Wyważenie	Waga
				Cal.	Cal.	Cal.	Cal.	Cal.	Cal.				lbs
EM25024011435	02469734	CAT40 ADB	G2	0.551	1.380	0.630	1.750	0.984	4.070	1	1	G6.3	2.120
EM25024011835	00056660	CAT40 ADB	G3	0.709	1.380	0.630	1.750	1.260	4.070	1	1	G6.3	2.090
EM25024012235	00056661	CAT40 ADB	G4	0.866	1.380	0.630	1.750	1.575	4.070	1	1	G6.3	2.030
EM25024012840	00056663	CAT40 ADB	G5	1.102	1.570	0.820	1.750	1.969	4.270	2	1	PB	1.980
EM250240128100	00056662	CAT40 ADB	G5	1.102	3.940	3.190	1.750	1.969	7.420	2	1	PB	3.860
EM25024013660	00056665	CAT40 ADB	G6	1.417	2.360	1.610	1.750	2.480	5.060	2	1	PB	2.710
EM25044011835	00056666	CAT50 ADB	G3	0.709	1.380	0.630	2.750	1.260	5.380	1	1	G6.3	6.720
EM25044012235	00056667	CAT50 ADB	G4	0.866	1.380	0.630	2.750	1.575	5.380	1	1	G6.3	6.530
EM25044012840	00056669	CAT50 ADB	G5	1.102	1.570	0.820	2.750	1.969	5.580	2	1	PB	6.590
EM250440128100	00056668	CAT50 ADB	G5	1.102	3.940	3.190	2.750	1.969	7.940	2	1	PB	8.380
EM25044013645	00056671	CAT50 ADB	G6	1.417	1.770	1.020	2.750	2.480	5.780	1	1	PB	7.050
EM250440136120	00056670	CAT50 ADB	G6	1.417	4.720	3.970	2.750	2.480	9.520	1	1	PB	10.140
EM25044014665	00056675	CAT50 ADB	G7	1.811	2.560	1.810	2.750	3.543	5.970	2	1	PB	8.330
EM250440146120	00056673	CAT50 ADB	G7	1.811	4.720	3.970	2.750	3.543	8.730	2	1	PB	13.800
EM250440146200	00056674	CAT50 ADB	G7	1.811	7.870	7.120	2.750	3.543	11.880	2	1	PB	22.750

Akcesoria



Dla wielkości

Klucz mocujący

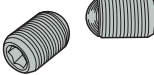

CAT40/ G2	03H025
CAT40/ G3	03H03
CAT40/ G4	03H04
CAT40/ G5	03H05
CAT40/ G6	03H06
CAT50/ G3	03H03
CAT50/ G4	03H04
CAT50/ G5	03H05
CAT50/ G6	03H06
CAT50/ G7	03H10

Części zamienne, zawarte w dostawie

Dla wielkości	Śruba mocująca	Śruba uszczelniająca
		
CAT40/ G2	90F2	950A0406
CAT40/ G3	90F3	950A0406
CAT40/ G4	90F4	950A0406
CAT40/ G5	90F5	950A0406
CAT40/ G6	90F6	950A0406
CAT50/ G3	90F3	950A0606
CAT50/ G4	90F4	950A0606
CAT50/ G5	90F5	950A0606
CAT50/ G6	90F6	950A0606
CAT50/ G7	90F7	950A0606

Wstęp

Wiercenie

Rozwiercanie

Wytaczanie

Załącznik

G 401 – Oprapki Graflex®

CAT TF / ASME B5.50-2009-ADB

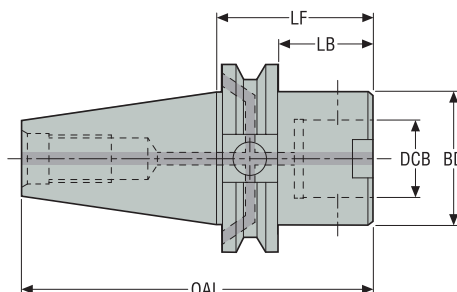

Oznaczenie	Numer produktu	CTMS	CTWS	DCB	LF	LB	BD	OAL	Wersja	RFID otwór	Wyważenie	Waga
				Cal.	Cal.	Cal.	Cal.	Cal.				lbs
EM26424011880	02998750	CAT40 TF ADB	G3	0.709	3.150	2.398	1.260	5.843	2	1	G6.3	2.650
EM26424012280	02998751	CAT40 TF ADB	G4	0.866	3.150	2.398	1.575	5.843	2	1	G6.3	3.090
EM264240128100	02998752	CAT40 TF ADB	G5	1.102	3.937	3.185	1.969	6.630	2	1	PB	4.190
EM264240136100	02998753	CAT40 TF ADB	G6	1.417	3.937	3.185	2.480	6.630	2	1	PB	5.070
EM264440122100	02964322	CAT50 TF ADB	G4	0.866	3.937	3.185	1.575	7.943	2	1	G6.3	7.280
EM264440128100	02964323	CAT50 TF ADB	G5	1.102	3.937	3.185	1.969	7.943	2	1	PB	7.940
EM264440136120	02926850	CAT50 TF ADB	G6	1.417	4.724	3.972	2.480	8.732	1	1	PB	10.140
EM264440146200	02926851	CAT50 TF ADB	G7	1.811	7.874	7.122	3.543	11.880	2	1	PB	22.710



Akcesoria

Dla wielkości	Klucz mocujący
EM26424011880	03H03
EM26424012280	03H04
EM264240128100	03H05
EM264240136100	03H06
EM264440122100	03H04
EM264440128100	03H05
EM264440136120	03H06
EM264440146200	03H10

Klucz mocujący

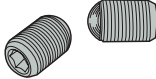

Części zamienne, zawarte w dostawie

Dla wiel- kości	Śruba mocująca	Śruba uszczelniająca
		
EM26424011880	90F3	950A0406
EM26424012280	90F4	950A0406
EM264240128100	90F5	950A0406
EM264240136100	90F6	950A0406
EM264440122100	90F4	950A0606
EM264440128100	90F5	950A0606
EM264440136120	90F6	950A0606
EM264440146200	90F7	950A0606

Wstęp

Wiercenie

Rozwiercanie

Wytaczanie

Załącznik

G 401 – Adaptery Graflex®

Seco-Capto™

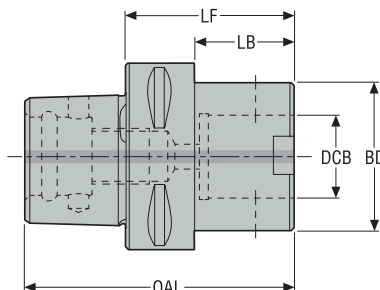

Oznaczenie	Numer produktu	CTMS	CTWS	DCB	LF	LB	BD	OAL	RFID otwór	Wywa- żenie	Waga
				mm <i>Cal.</i>	mm <i>Cal.</i>	mm <i>Cal.</i>	mm <i>Cal.</i>	mm <i>Cal.</i>			kg <i>lbs</i>
C3-391.0401-08025	02532939	C3	G0	8,0 0.315	25,0 0.984	7,0 0.276	16,0 0.630	44,0 1.732	0	G6.3	0,14 0.310
C3-391.0401-11025	02532940	C3	G1	11,0 0.433	25,0 0.984	7,0 0.276	20,0 0.787	44,0 1.732	0	G6.3	0,14 0.310
C3-391.0401-14025	02532941	C3	G2	14,0 0.551	25,0 0.984	7,0 0.276	25,0 0.984	44,0 1.732	0	G6.3	0,15 0.330
C3-391.0401-18030	02532942	C3	G3	18,0 0.709	30,0 1.181	0,0 -	32,0 1.260	49,0 1.929	0	G6.3	0,16 0.350
C4-391.0401-18035	02532943	C4	G3	18,0 0.709	35,0 1.378	12,0 0.472	32,0 1.260	59,0 2.323	0	G6.3	0,31 0.680
C4-391.0401-22035	02532944	C4	G4	22,0 0.866	35,0 1.378	0,0 -	40,0 1.575	59,0 2.323	0	G6.3	0,31 0.680
C5-391.0401-14030	02532945	C5	G2	14,0 0.551	30,0 1.181	7,0 0.276	25,0 0.984	60,0 2.362	1	G6.3	0,47 1.040
C5-391.0401-18035	02532947	C5	G3	18,0 0.709	35,0 1.378	12,0 0.472	32,0 1.260	65,0 2.559	1	G6.3	0,47 1.040
C5-391.0401-22035	02532948	C5	G4	22,0 0.866	35,0 1.378	12,0 0.472	40,0 1.575	65,0 2.559	1	G6.3	0,51 1.120
C5-391.0401-28045	02532949	C5	G5	28,0 1.102	45,0 1.772	22,0 0.866	50,0 1.969	75,0 2.953	1	PB	0,64 1.410
C6-391.0401-18035	02532950	C6	G3	18,0 0.709	35,0 1.378	10,0 0.394	32,0 1.260	73,0 2.874	1	G6.3	0,84 1.850
C6-391.0401-22040	02532951	C6	G4	22,0 0.866	40,0 1.575	15,0 0.591	40,0 1.575	78,0 3.071	1	G6.3	0,89 1.960
C6-391.0401-28050	02532952	C6	G5	28,0 1.102	50,0 1.969	25,0 0.984	50,0 1.969	88,0 3.465	1	PB	1,04 2.290
C6-391.0401-36055	02532953	C6	G6	36,0 1.417	55,0 2.165	0,0 -	63,0 2.480	93,0 3.661	1	PB	1,19 2.620
C8-391.0401-28050	02532954	C8	G5	28,0 1.102	50,0 1.969	17,0 0.669	50,0 1.969	98,0 3.858	1	PB	1,92 4.230
C8-391.0401-36055	02532955	C8	G6	36,0 1.417	55,0 2.165	22,0 0.866	63,0 2.480	103,0 4.055	1	PB	2,02 4.450
C8-391.0401-46065	02532956	C8	G7	46,0 1.811	65,0 2.559	35,0 1.378	90,0 3.543	113,0 4.449	1	PB	2,71 5.970

Akcesoria

Dla wielkości	Klucz mocujący
	
G0	03H02
G1	03H02
G2	03H025
G3	03H03
G4	03H04
G5	03H05
G6	03H06
G7	03H10

Części zamienne, zawarte w dostawie

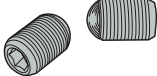
Dla wielkości	Śruba mocująca
	
G0	90F0
G1	90F1
G2	90F2
G3	90F3
G4	90F4
G5	90F5
G6	90F6
G7	90F7

G 402 – Przedłużki Graflex®

Graflex®

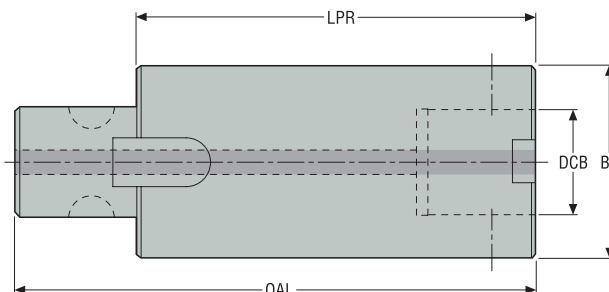

Oznaczenie	Numer produktu	CTMS	CTWS	LPR	DCB	BD	OAL	RFID otwór	Wyważenie	Waga
				mm Cal.	mm Cal.	mm Cal.	mm Cal.			kg lbs
M402000	00056752	G0	G0	30,0 1.181	8,0 0.315	16,0 0.630	42,0 1.654	0	PB	0,05 0.110
M402001	00056753	G0	G0	50,0 1.969	8,0 0.315	16,0 0.630	62,0 2.441	0	PB	0,08 0.180
M402110	00056754	G1	G1	30,0 1.181	11,0 0.433	20,0 0.787	43,0 1.693	0	PB	0,07 0.150
M402111	00056755	G1	G1	50,0 1.969	11,0 0.433	20,0 0.787	63,0 2.480	0	PB	0,12 0.260
M402220	00056756	G2	G2	30,0 1.181	14,0 0.551	25,0 0.984	46,0 1.811	0	PB	0,11 0.240
M402221	00056757	G2	G2	50,0 1.969	14,0 0.551	25,0 0.984	66,0 2.598	0	PB	0,18 0.400
M402330	00056758	G3	G3	40,0 1.575	18,0 0.709	32,0 1.260	60,0 2.362	0	PB	0,24 0.530
M402331	75056759	G3	G3	60,0 2.362	18,0 0.709	32,0 1.260	80,0 3.150	0	PB	0,36 0.790
M402440	00056760	G4	G4	40,0 1.575	22,0 0.866	40,0 1.575	64,0 2.520	0	PB	0,37 0.820
M402441	00056761	G4	G4	60,0 2.362	22,0 0.866	40,0 1.575	84,0 3.307	0	PB	0,57 1.260
M402444	02786252	G4	G4	200,0 7.874	22,0 0.866	40,0 1.575	224,0 8.819	0	PB	1,95 4.300
M402550	00056762	G5	G5	50,0 1.969	28,0 1.102	50,0 1.969	80,0 3.150	0	PB	0,72 1.590
M402551	00056763	G5	G5	75,0 2.953	28,0 1.102	50,0 1.969	105,0 4.134	0	PB	1,12 2.470
M402552	00056764	G5	G5	100,0 3.937	28,0 1.102	50,0 1.969	130,0 5.118	0	PB	1,48 3.260
M402554	02786254	G5	G5	250,0 9.843	28,0 1.102	50,0 1.969	280,0 11.024	0	PB	3,9 8.600
M402660	00056765	G6	G6	60,0 2.362	36,0 1.417	63,0 2.480	100,0 3.937	0	PB	1,38 3.040
M402661	00056766	G6	G6	90,0 3.543	36,0 1.417	63,0 2.480	130,0 5.118	0	PB	2,1 4.630
M402662	00056767	G6	G6	120,0 4.724	36,0 1.417	63,0 2.480	160,0 6.299	0	PB	2,82 6.220
M402664	02786255	G6	G6	300,0 11.811	36,0 1.417	63,0 2.480	340,0 13.386	0	PB	7,2 15.870
M402770	00056768	G7	G7	60,0 2.362	46,0 1.811	90,0 3.543	110,0 4.331	0	-	2,9 6.390
M402771	00056769	G7	G7	90,0 3.543	46,0 1.811	90,0 3.543	140,0 5.512	0	-	4,03 8.880

Wstęp

Wiercenie

Rozwiercanie

Wytaczanie

Załącznik

Oznaczenie	Numer produktu	CTMS	CTWS	LPR	DCB	BD	OAL	RFID otwór	Wyważenie	Waga
				mm Cal.	mm Cal.	mm Cal.	mm Cal.			kg lbs
M402772	00056770	G7	G7	120,0 4.724	46,0 1.811	90,0 3.543	170,0 6.693	0	-	5,8 12.790
M402774	02786257	G7	G7	300,0 11.811	46,0 1.811	90,0 3.543	350,0 13.780	0	-	14,6 32.190

Akcesoria

Dla wielkości	Klucz mocujący
G0	03H02
G1	03H02
G2	03H025
G3	03H03
G4	03H04
G5	03H05
G6	03H06
G7	03H10

Części zamienne, zawarte w dostawie

Dla wielkości	Śruba mocująca	Zabierak
G0	90F0	90M0
G1	90F1	90M1
G2	90F2	90M2
G3	90F3	90M3
G4	90F4	90M4
G5	90F5	90M5
G6	90F6	90M6
G7	90F7	90M7

G 403 – Redukcje Graflex®

Graflex®

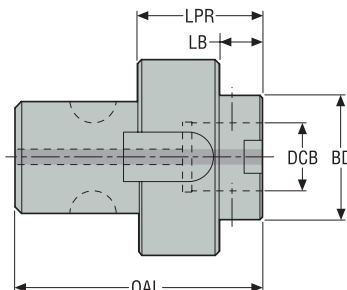



Oznaczenie	Numer produktu	CTMS	CTWS	LPR	LB	DCB	BD	OAL	RFID otwór	Wyważenie	Waga
				mm Cal.	mm Cal.	mm Cal.	mm Cal.	mm Cal.			kg lbs
M40310	00056771	G1	G0	30,0 1.181	22,0 0.866	8,0 0.315	16,0 0.630	43,0 1.693	0	PB	0,06 0.130
M40320	00056772	G2	G0	30,0 1.181	19,0 0.748	8,0 0.315	16,0 0.630	46,0 1.811	0	PB	0,08 0.180
M40321	00056773	G2	G1	30,0 1.181	19,0 0.748	11,0 0.433	20,0 0.787	46,0 1.811	0	PB	0,1 0.220
M40330	00056774	G3	G0	30,0 1.181	16,0 0.630	8,0 0.315	16,0 0.630	50,0 1.969	0	PB	0,15 0.330
M40331	00056775	G3	G1	30,0 1.181	16,0 0.630	11,0 0.433	20,0 0.787	50,0 1.969	0	PB	0,15 0.330
M40332	00056776	G3	G2	30,0 1.181	16,0 0.630	14,0 0.551	25,0 0.984	50,0 1.969	0	PB	0,16 0.350
M40341	00056778	G4	G1	30,0 1.181	13,0 0.512	11,0 0.433	20,0 0.787	54,0 2.126	0	PB	0,25 0.550
M40342	00056779	G4	G2	30,0 1.181	13,0 0.512	14,0 0.551	25,0 0.984	54,0 2.126	0	PB	0,27 0.600
M40343	00056780	G4	G3	30,0 1.181	13,0 0.512	18,0 0.709	32,0 1.260	54,0 2.126	0	PB	0,27 0.600
M40350	00056781	G5	G0	40,0 1.575	20,0 0.787	8,0 0.315	16,0 0.630	70,0 2.756	0	PB	0,47 1.040
M40351	00056783	G5	G1	40,0 1.575	20,0 0.787	11,0 0.433	20,0 0.787	70,0 2.756	0	PB	0,49 1.080
M40352	00056785	G5	G2	40,0 1.575	20,0 0.787	14,0 0.551	25,0 0.984	70,0 2.756	0	PB	0,49 1.080
M40353	00056787	G5	G3	40,0 1.575	20,0 0.787	18,0 0.709	32,0 1.260	70,0 2.756	0	PB	0,52 1.150
M40354	00056789	G5	G4	40,0 1.575	20,0 0.787	22,0 0.866	40,0 1.575	70,0 2.756	0	PB	0,55 1.210
M40363	00056797	G6	G3	40,0 1.575	14,0 0.551	18,0 0.709	32,0 1.260	80,0 3.150	0	PB	0,98 2.160
M40364	00056799	G6	G4	40,0 1.575	14,0 0.551	22,0 0.866	40,0 1.575	80,0 3.150	0	PB	0,97 2.140
M40365	00056807	G6	G5	45,0 1.772	19,0 0.748	28,0 1.102	50,0 1.969	85,0 3.346	0	PB	1,04 2.290
M40375	00056811	G7	G5	50,0 1.969	24,0 0.945	28,0 1.102	50,0 1.969	100,0 3.937	0	-	2,08 4.590
M40376	00056812	G7	G6	55,0 2.165	29,0 1.142	36,0 1.417	63,0 2.480	105,0 4.134	0	-	2,23 4.920

Akcesoria

Dla wielkości	Klucz mocujący
	
M40310	03H02
M40320	03H02
M40321	03H02
M40330	03H02
M40331	03H02
M40332	03H025
M40341	03H02
M40342	03H025
M40343	03H03
M40350	03H02
M40351	03H02
M40352	03H025
M40353	03H03
M40354	03H04
M40363	03H03
M40364	03H04
M40365	03H05
M40375	03H05
M40376	03H06

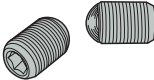
Części zamienne, zawarte w dostawie

Dla wielkości	Śruba mocująca	Zabierak
		
M40310	90F0	90M1
M40320	90F0	90M2
M40321	90F1	90M2
M40330	90F0	90M3
M40331	90F1	90M3
M40332	90F2	90M3
M40341	90F1	90M4
M40342	90F2	90M4
M40343	90F3	90M4
M40350	90F0	90M5
M40351	90F1	90M5
M40352	90F2	90M5
M40353	90F3	90M5
M40354	90F4	90M5
M40363	90F3	90M6
M40364	90F4	90M6
M40365	90F5	90M6
M40375	90F5	90M7
M40376	90F6	90M7

G 403 – Długie redukcje Graflex®

Graflex®

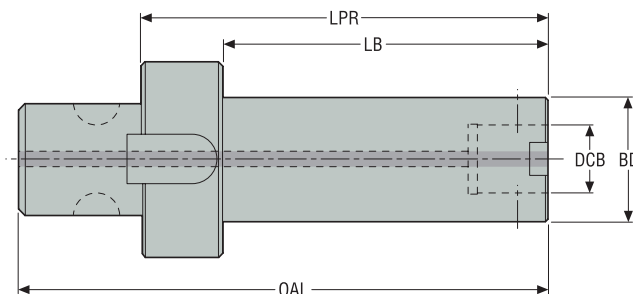

Oznaczenie	Numer produktu	CTMS	CTWS	LPR	LB	DCB	BD	OAL	RFID otwór	Wyważenie	Waga
				mm <i>Cal.</i>	mm <i>Cal.</i>	mm <i>Cal.</i>	mm <i>Cal.</i>	mm <i>Cal.</i>			kg <i>lbs</i>
M40350070	00056782	G5	G0	70,0 2.756	50,0 1.969	8,0 0.315	16,0 0.630	100,0 3.937	0	PB	0,51 1.120
M40351080	00056784	G5	G1	80,0 3.150	60,0 2.362	11,0 0.433	20,0 0.787	110,0 4.331	0	PB	0,57 1.260
M40352100	00056786	G5	G2	100,0 3.937	80,0 3.150	14,0 0.551	25,0 0.984	130,0 5.118	0	PB	0,71 1.570
M40353120	00056788	G5	G3	120,0 4.724	100,0 3.937	18,0 0.709	32,0 1.260	150,0 5.906	0	PB	1,02 2.250
M40354150	00056790	G5	G4	150,0 5.906	130,0 5.118	22,0 0.866	40,0 1.575	180,0 7.087	0	PB	1,62 3.570
M40361090	00056794	G6	G1	90,0 3.543	64,0 2.520	11,0 0.433	20,0 0.787	130,0 5.118	0	PB	1,08 2.380
M40362110	00056796	G6	G2	110,0 4.331	84,0 3.307	14,0 0.551	25,0 0.984	150,0 5.906	0	PB	1,23 2.710
M40363120	00056798	G6	G3	120,0 4.724	94,0 3.701	18,0 0.709	32,0 1.260	160,0 6.299	0	PB	1,46 3.220
M40364150	00056800	G6	G4	150,0 5.906	124,0 4.882	22,0 0.866	40,0 1.575	190,0 7.480	0	PB	2,07 4.560
M40365190	00056808	G6	G5	190,0 7.480	164,0 6.457	28,0 1.102	50,0 1.969	230,0 9.055	0	PB	3,2 7.050

Akcesoria



Dla wiel-
kości

Klucz mocujący

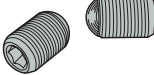

M40350070	03H02
M40351080	03H02
M40352100	03H025
M40353120	03H03
M40354150	03H04
M40361090	03H02
M40362110	03H025
M40363120	03H03
M40364150	03H04
M40365190	03H05

Części zamienne, zawarte w dostawie

Dla wielkości	Śruba mocująca	Zabierak
		
M40350070	90F0	90M5
M40351080	90F1	90M5
M40352100	90F2	90M5
M40353120	90F3	90M5
M40354150	90F4	90M5
M40361090	90F1	90M6
M40362110	90F2	90M6
M40363120	90F3	90M6
M40364150	90F4	90M6
M40365190	90F5	90M6

Wstęp

Wiercenie

Rozwiercanie

Wytaczanie

Załącznik

G 403 – Elementy powiększające Graflex®

Graflex®

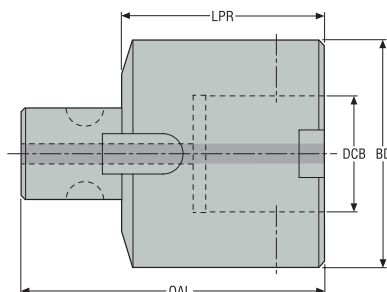

Oznaczenie	Numer produktu	CTMS	CTWS	LPR	DCB	BD	OAL	RFID otwór	Wyważenie	Waga
				mm Cal.	mm Cal.	mm Cal.	mm Cal.			kg lbs
M40356	00056791	G5	G6	55,0 2.165	36,0 1.417	63,0 2.480	85,0 3.346	0	PB	1,08 2.380
M40367	00056810	G6	G7	80,0 3.150	46,0 1.811	90,0 3.543	120,0 4.724	0	PB	3,46 7.630

Akcesoria

Dla	Klucz mocujący
M40356	03H06
M40367	03H10

Części zamienne, zawarte w dostawie

Dla	Śruba mocująca	Zabierak
M40356	90F6	90M5
M40367	90F7	90M6

Wstęp

Wiercenie

Rozwiercanie

Wytaczanie

Załącznik

G 401 – Oprawki Graflex® stalowe

Cylindryczne

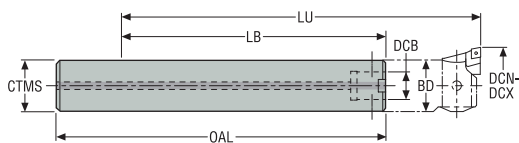

- Nadaje się do wytaczania dokładnego do LU z zamontowaną głowicą wytaczającą typ A780 lub A790
- Cylindryczna część CTMS wykonana w tolerancji h5, nadaje się do opravek Shrinkfit

Oznaczenie	Numer produktu	CTMS	CTWS	DCB	DCN	DCX	OAL	BD	LU	LB	RFID otwór	Wywa- żenie	Waga
				mm Cal.	mm Cal.	mm Cal.	mm Cal.	mm Cal.	mm Cal.	mm Cal.			kg lbs
M4011408	00086938	14	G0	8,0 0.315	15,0 0.591	18,5 0.728	120,0 4.724	14,0 0.551	110,0 4.331	75,0 2.953	0	G6.3	0,12 0.260
M4011608	00086935	16	G0	8,0 0.315	18,0 0.709	23,5 0.925	150,0 5.906	16,0 0.630	137,0 5.394	102,0 4.016	0	G6.3	0,2 0.440
M4012011	00086936	20	G1	11,0 0.433	23,0 0.906	31,0 1.220	150,0 5.906	20,0 0.787	140,0 5.512	100,0 3.937	0	G6.3	0,33 0.730
M4012514	00086937	25	G2	14,0 0.551	30,0 1.181	40,0 1.575	150,0 5.906	25,0 0.984	139,0 5.472	93,0 3.661	0	G6.3	0,53 1.170
M4013218	00086939	32	G3	18,0 0.709	39,0 1.535	51,0 2.008	150,0 5.906	32,0 1.260	155,0 6.102	90,0 3.543	0	G6.3	0,87 1.920

Części zamienne, zawarte w dostawie

Dla	Śruba mocująca
M4011408	90F01
M4011608	90F0
M4012011	90F1
M4012514	90F2
M4013218	90F3

Akcesoria

Dla	Klucz mocujący
M4011408	03H025
M4011608	03H02
M4012011	03H02
M4012514	03H025
M4013218	03H03

G 401 – Oprawki Graflex® stalowe

Cylindryczne

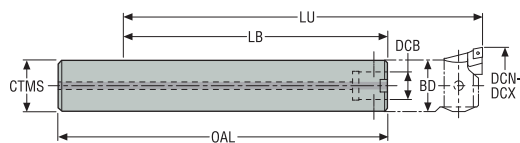

- Nadaje się do wytaczania dokładnego do LU z zamontowaną głowicą wytaczającą typ A780 lub A790
- Cylindryczna część CTMS wykonana w tolerancji h5, nadaje się do opravek Shrinkfit

Oznaczenie	Numer produktu	CTMS	CTWS	DCB	DCN	DCX	OAL	BD	LU	LB	RFID otwór	Wyważenie	Waga
		Cal.		Cal.	Cal.	Cal.	Cal.	Cal.	Cal.	Cal.			lbs
M40107511	00056741	0.750	G1	0.433	0.906	1.220	5.906	0.827	5.510	3.906	0	G6.3	0.640

Części zamienne, zawarte w dostawie

Dla	Śruba mocująca	Klucz mocujący
M40107511	90F1	03H02

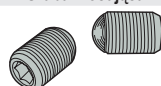

Wstęp

Wiercenie

Rozwiercanie

Wytaczanie

Załącznik

G 401 – Oprapki Graflex® węglkowe

Cylindryczne

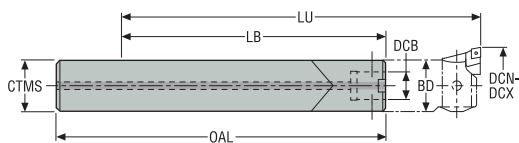

- Nadaje się do wytaczania dokładnego do LU z zamontowaną głowicą wytaczającą typ A780 lub A790
- Tolerancja CTMS h5

Oznaczenie	Numer produktu	CTMS	CTWS	DCB	DCN	DCX	OAL	BD	LU	LB	RFID otwór	Wyważenie	Waga
				mm Cal.	mm Cal.	mm Cal.	mm Cal.	mm Cal.	mm Cal.	mm Cal.			kg lbs
M4011408C	00073004	14	G0	8,0 0.315	15,0 0.591	18,5 0.728	152,0 5.984	14,0 0.551	140,0 5.512	105,0 4.134	0	G6.3	0,31 0.680
M4011608C	00056747	16	G0	8,0 0.315	18,0 0.709	23,5 0.925	175,0 6.890	16,0 0.630	160,0 6.299	125,0 4.921	0	G6.3	0,5 1.100
M4012011C	00056749	20	G1	11,0 0.433	23,0 0.906	31,0 1.220	212,0 8.346	20,0 0.787	200,0 7.874	160,0 6.299	0	G6.3	0,89 1.960
M4012514C	00056750	25	G2	14,0 0.551	30,0 1.181	40,0 1.575	262,0 10.315	25,0 0.984	250,0 9.843	204,0 8.031	0	G6.3	1,71 3.770
M4013218C	00056751	32	G3	18,0 0.709	39,0 1.535	51,0 2.008	317,0 12.480	32,0 1.260	320,0 12.598	255,0 10.039	0	G6.3	3,44 7.580

Części zamienne, zawarte w dostawie

Dla

Śruba mocująca

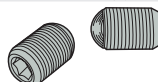

M4011408C

90F01

M4011608C

90F0

M4012011C

90F1

M4012514C

90F2

M4013218C

90F3

Akcesoria

Dla

Klucz mocujący



M4011408C

03H025

M4011608C

03H02

M4012011C

03H02

M4012514C

03H025

M4013218C

03H03

G 403 – Bardzo długie reduktory Graflex® węglkowe

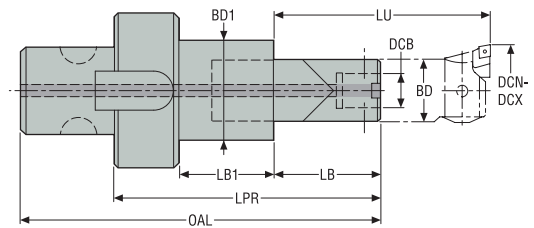

- Część przedłużki wykonana z węgla
- Nadaje się do wytaczania dokładnego do LU z zamontowaną głowicą wytaczającą typ A780 lub A790

Oznaczenie	Numer produktu	CTMS	CTWS	DCB	DCN	DCX	LPR	LU	BD	BD1	LB1	LB	OAL	RFID otwór	Wywa- żenie	Waga
				mm <i>Cal.</i>	mm <i>Cal.</i>	mm <i>Cal.</i>	mm <i>Cal.</i>	mm <i>Cal.</i>	mm <i>Cal.</i>	mm <i>Cal.</i>	mm <i>Cal.</i>	mm <i>Cal.</i>	mm <i>Cal.</i>			kg <i>lbs</i>
M40350C150	00057604	G5	G0	8,0 0.315	18,0 0.709	23,5 0.925	150,0 5.906	130,0 5.118	16,0 0.630	32,0 0.630	35,0 1.378	95,0 3.740	180,0 7.087	0	PB	1,0 2.200
M40351C180	00056943	G5	G1	11,0 0.433	23,0 0.906	31,0 1.220	180,0 7.087	160,0 6.299	20,0 0.787	36,0 0.787	40,0 1.575	120,0 4.724	210,0 8.268	0	PB	1,33 2.930
M40352C220	00057605	G5	G2	14,0 0.551	30,0 1.181	40,0 1.575	220,0 8.661	200,0 7.874	25,0 0.984	41,0 0.984	45,0 1.772	155,0 6.102	250,0 9.843	0	PB	2,01 4.430

Części zamienne, zawarte w dostawie

Dł	Śruba mocująca	Zabierak
M40350C150	90F0	90M5
M40351C180	90F1	90M5
M40352C220	90F2	90M5

Akcesoria

Dł	Klucz mocujący
M40350C150	03H02
M40351C180	03H02
M40352C220	03H025

Przewody do chłodziwa, klucze i zaślepki uszczelniające dla HSK

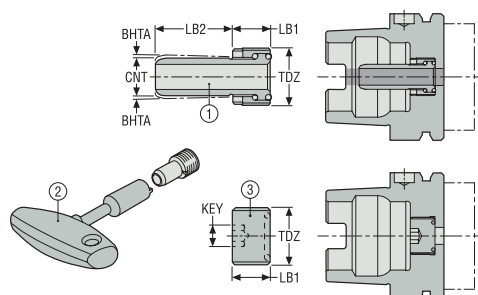

- Oprawki HSK-A na Seco-Capto dostarczane są ze specjalnymi przewodami na chłodziwo, dostępnymi jako części zamienne, wymagają one użycia specjalnego klucza, patrz str. 530, 531-532, 533

Opis	Oznaczenie	Numer produktu	Do opravek HSK Forma A i E	LB1	LB2	KEY	CNT	TDZ	BHTA°
				mm Cal.	mm Cal.	mm Cal.	mm		
Przewody do chłodziwa (1)*	20E9301	00088814	HSK-A32 & HSK-E32	5,5 0.217	20,5 0.807	-	6	M10x1	1,0
	20E9302	00088815	HSK-A40 & HSK-E40	7,5 0.295	22,0 0.866	-	8	M12x1	1,0
	20E9303	00086740	HSK-A50 & HSK-E50	9,5 0.374	23,5 0.925	-	6	M16x1	1,0
	20E9304	00086741	HSK-A63 & HSK-E63	11,5 0.453	25,0 0.984	-	8	M18x1	1,0
	20E9306	00086742	HSK-A100 & HSK-E100	15,5 0.610	28,5 1.122	-	6	M24x1,5	1,0
	20E9307	00088816	HSK-A125	17,5 0.689	30,5 1.201	-	18	M30x1.5	1,0
	Klucze do przewodów (2)	03E9301	00088811	HSK-A32 & HSK-E32	-	-	-	-	-
03E9302		00088812	HSK-A40 & HSK-E40	-	-	-	-	-	-
03E9303		00069969	HSK-A50 & HSK-E50	-	-	-	-	-	-
03E9304		00069970	HSK-A63 & HSK-E63	-	-	-	-	-	-
03E9305		00032296	HSK-A80 & HSK-E80	-	-	-	-	-	-
03E9306		00084012	HSK-A100 & HSK-E100	-	-	-	-	-	-
5680094-07		03248614	HSK-A125	-	-	-	-	-	-
Korki uszczelniające (3)	02E9301	00031588	HSK-A32 & HSK-E32	5,0 0.197	-	3,0 0.118	-	M10x1	-
	02E9302	00031593	HSK-A40 & HSK-E40	7,0 0.276	-	4,0 0.157	-	M12x1	-
	02E9303	00001002	HSK-A50 & HSK-E50	9,0 0.354	-	5,0 0.197	-	M16x1	-
	02E9304	00010101	HSK-A63 & HSK-E63	11,0 0.433	-	6,0 0.236	-	M18x1	-
	02E9306	00014002	HSK-A100 & HSK-E100	15,0 0.591	-	10,0 0.394	-	M24x1,5	-
	02E9307	00033649	HSK-A125	17,0 0.669	-	12,0 0.472	-	M30x1.5	-



Seco-Capto™

Seco-Capto™ to najwyższej klasy modułowy system szybkozłączny umożliwiający sprawną konfigurację i wymianę opravek narzędzi skrawających. W oprawkach modułowym Seco-Capto™ zastosowano chwyt wielokątny (Polygonal Shank Coupling, PSC) zgodny z normą ISO 26623 oraz samoczynnie blokujące połączenie stożkowe.

- Gama opravek narzędziowych, takich jak Shrinkfit, tulejki zaciskowe i oprawki
- Podstawowe oprawki Seco-Capto™ ze złączami HSK, DIN, BT
- Kasetta Seco-Capto™ zapewniająca większą niezawodność i pewniejsze zaciskanie płytek

Seco-Capto™, wymiary według normy

ISO 26623-1-PSC/ ISO 26623-2-PSC

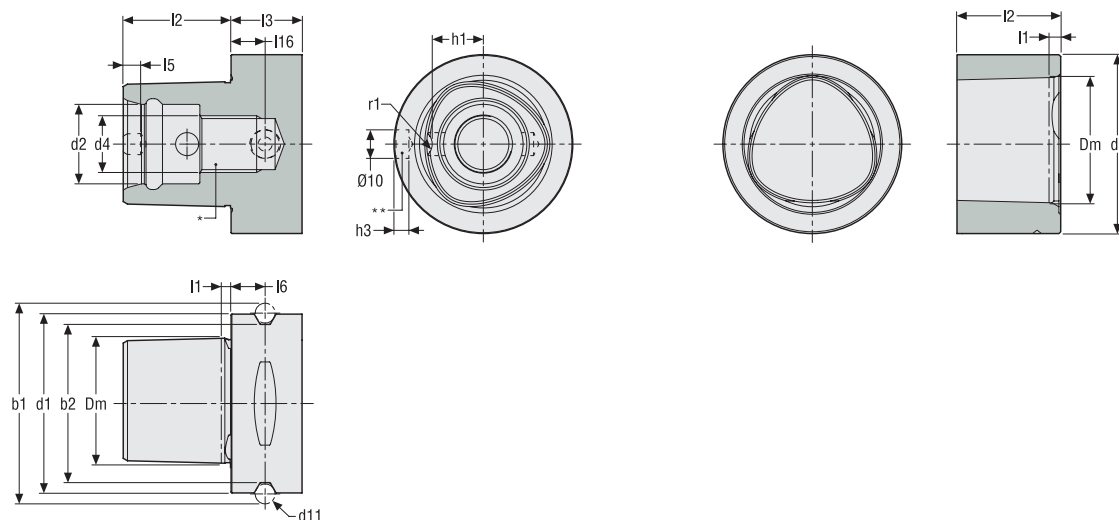

Oznaczenie katalogowe Strona wrzeciona	Pogłębienie dla RFID**	d ₁	d ₂	d ₄	d ₁₁	Dm	b ₁	b ₂	l ₁	l ₂	l _{3 min}	l ₅	l ₆	l ₁₆	h ₁	h ₃	r ₁
		mm Cal.	mm Cal.		mm Cal.	mm Cal.	mm Cal.	mm Cal.	mm Cal.	mm Cal.	mm Cal.	mm Cal.	mm Cal.	mm Cal.	mm Cal.	mm Cal.	mm Cal.
C3	Nie**	32 1.260	15 0.591	M12	5 0.197	22 0.866	39 1.535	28,3 1.114	2,5 0.098	19 0.748	15 0.591	3,2 0.126	6 0.236	9 0.354	9 0.354	5,4 0.213	3 0.118
C4	Nie**	40 1.575	18 0.709	M14	5 0.197	28 1.102	46 1.811	35,3 1.390	2,5 0.098	24 0.945	20 0.787	4 0.157	8 0.315	12 0.472	11 0.433	5,2 0.205	3 0.118
C5	**	50 1.969	21 0.827	M16	7 0.276	35 1.378	59,3 2.335	44,4 1.748	3 0.118	30 1.181	20 0.787	5,3 0.209	10 0.394	12 0.472	14 0.551	5,1 0.201	4 0.157
C6	**	63 2.480	28 1.102	M20	7 0.276	44 1.732	70,7 2.783	55,8 2.197	3 0.118	38 1.496	22 0.866	6,2 0.244	12 0.472	12 0.472	18 0.709	5 0.197	5 0.197
C8	**	80 3.150	32 1.260	M20	7 0.276	55 2.165	86 3.386	71,1 2.799	3 0.118	48 1.890	30 1.181	8 0.315	12 0.472	12 0.472	22,2 0.874	4,9 0.193	6 0.236

Oznaczenie katalogowe Strona wrzeciona	Pogłębienie dla RFID**	d _{1 min}	d ₃	Dm	l ₁	l ₂	l ₃	l ₄
		mm Cal.	mm Cal.	mm Cal.	mm Cal.	mm Cal.	mm Cal.	mm Cal.
C3	Nie	32 1.260	2 0.079	22 0.866	2,3 0.091	18,4 0.724	16,5 0.650	9,4 0.370
C4	Nie	40 1.575	2,5 0.098	28 1.102	2,3 0.091	23,4 0.921	21 0.827	11,5 0.453
C5	Nie	50 1.969	3 0.118	35 1.378	2,8 0.110	29,4 1.157	26 1.024	14,5 0.571
C6	**	63 2.480	4 0.157	44 1.732	2,8 0.110	37,4 1.472	33,5 1.319	18,5 0.728
C8	**	80 3.150	5 0.197	55 2.165	2,8 0.110	47,4 1.866	43 1.693	22,8 0.898

Uwaga: Następujące wymiary według norm są stosowane do wszystkich opravek pokazanych na stronach produktów.

* Oprawki z gniazdem Seco-Capto™ po stronie obrabiarki mogą być mocowane we wrzecionach z tuleją segmentową (a nie ze śrubą centralną). Redukcje z gniazdem Seco-Capto™ po stronie obrabiarki mogą być mocowane we wrzecionach z tuleją segmentową (a nie ze śrubą centralną).

** Informacja czy oprawka posiada pogłębienie pod RFID znajduje się w tabeli produktu, kolumna 'Pogłębienie pod RFID': 1= oprawka posiada pogłębienie pod RFID, na żądanie może być zamocowany układ RFID, prosimy pytać.

0= brak pogłębienia pod RFID, jeśli jest taka potrzeba, może być wykonane pogłębienie oraz zamocowany układ RFID, prosimy pytać.

C 00 – Oprawki DIN 2080 Seco-Capto™ – ISO 26623-2

DIN 2080

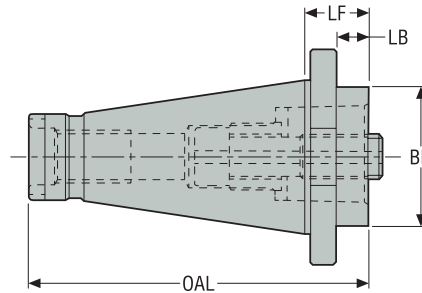
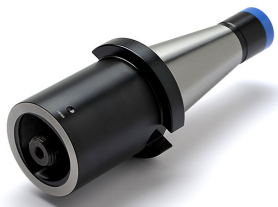



Oznaczenie	Numer produktu	CTMS	CTWS	LF	LB	BD	OAL	RFID otwór	Wyważenie	Waga
				mm Cal.	mm Cal.	mm Cal.	mm Cal.			kg lbs
C3-390.00-40030	75039844	DIN(2080)40	C3	30,0 1.181	18,4 0.724	32,0 1.260	123,4 4.858	0	-	0,9 1.980
C4-390.00-40030	75039848	DIN(2080)40	C4	30,0 1.181	18,4 0.724	40,0 1.575	123,4 4.858	0	-	1,0 2.200
C4-390.00-40060	75039849	DIN(2080)40	C4	60,0 2.362	48,4 1.906	40,0 1.575	153,4 6.039	0	-	1,08 2.380
C5-390.00-40030	75039852	DIN(2080)40	C5	30,0 1.181	18,4 0.724	50,0 1.969	123,4 4.858	0	-	0,81 1.790
C6-390.00-40075	00048158	DIN(2080)40	C6	75,0 2.953	0,0 -	63,0 2.480	168,4 6.630	0	-	1,82 4.010
C3-390.00-50030	75039846	DIN(2080)50	C3	30,0 1.181	14,8 0.583	32,0 1.260	156,8 6.173	0	-	2,5 5.510
C3-390.00-50060	75039847	DIN(2080)50	C3	60,0 2.362	44,8 1.764	32,0 1.260	186,8 7.354	0	-	2,5 5.510
C4-390.00-50030	75039850	DIN(2080)50	C4	30,0 1.181	14,8 0.583	40,0 1.575	156,8 6.173	0	-	2,5 5.510
C4-390.00-50060	75039851	DIN(2080)50	C4	60,0 2.362	44,8 1.764	40,0 1.575	186,8 7.354	0	-	2,5 5.510
C5-390.00-50030	75039854	DIN(2080)50	C5	30,0 1.181	14,8 0.583	50,0 1.969	156,8 6.173	0	-	2,62 5.780
C5-390.00-50070	75039855	DIN(2080)50	C5	70,0 2.756	54,8 2.157	50,0 1.969	196,8 7.748	0	-	3,29 7.250
C6-390.00-50030	75039856	DIN(2080)50	C6	30,0 1.181	14,8 0.583	63,0 2.480	156,8 6.173	0	-	2,56 5.640
C6-390.00-50080	75039857	DIN(2080)50	C6	80,0 3.150	64,8 2.551	63,0 2.480	206,8 8.142	0	-	3,27 7.210
C8-390.00-50070	75039858	DIN(2080)50	C8	70,0 2.756	54,8 2.157	80,0 3.150	196,8 7.748	0	-	3,8 8.380
C8-390.00-50120	75039859	DIN(2080)50	C8	120,0 4.724	104,8 4.126	80,0 3.150	246,8 9.717	0	-	5,6 12.350

Akcesoria

Dla	Klucz przedłużony	Klucz
C3	5680015-05	5680065-13
C4	5680015-05	5680065-10
C5	5680015-01	5680065-11
C6-400	5680015-01	5680065-12
C6-500	5680015-02	5680065-12
C8	5680015-02	5680065-12

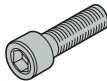
Części zamienne, zawarte w dostawie

Dla	Śruba centralna	Nakrętka ustalająca
		
C3	5512063-10	5512091-04
C4	5512063-07	5512091-03
C5	5512063-08	5512091-01
C6-400	5512063-13	5512091-02
C6-500	5512063-09	5512091-02
C8	5512063-09	5512091-02

Akcesoria / Części zamienne

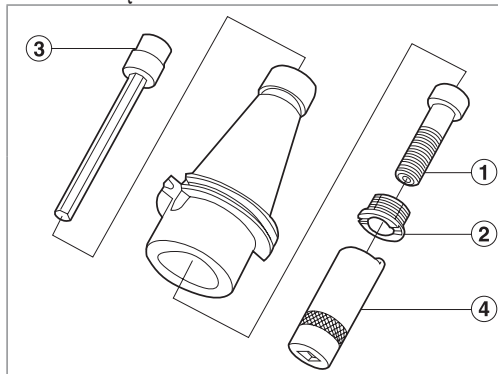

Akcesoria:
3 = Klucz przedłużony
4 = Klucz

Części zamienne:
1 = Śruba centralna
2 = Nakrętka zabezpieczająca

C 55/58 – Oprapki CAT Seco-Capto™

CAT / ASME B5.50-2009-ADB

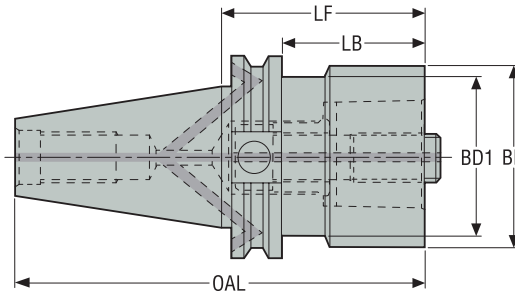



Oznaczenie	Numer produktu	CTMS	CTWS	LF	LB	BD	BD1	OAL	Wersja	RFID otwór	Wyważenie	Waga
				<i>Cal.</i>	<i>Cal.</i>	<i>Cal.</i>	<i>Cal.</i>	<i>Cal.</i>				lbs
C3-A390B.45-40060	02925929	CAT40 ADB	C3	2.362	1.610	1.260	1.260	5.055	2	0	PB	2.200
C4-A390B.45-40030	02925932	CAT40 ADB	C4	1.181	0.429	1.575	1.575	3.874	2	0	PB	1.830
C4-A390B.45-40060	02925933	CAT40 ADB	C4	2.362	1.610	1.575	1.575	5.055	2	0	PB	2.430
C5-A390B.45-40040	02925935	CAT40 ADB	C5	1.575	0.823	1.969	1.969	4.268	2	0	PB	2.050
C5-A390B.45-40080	02925936	CAT40 ADB	C5	3.150	2.398	1.969	1.969	5.843	2	0	PB	3.310
C6-A390B.45-40085	02925939	CAT40 ADB	C6	3.346	1.378	2.480	2.480	6.039	2	0	PB	4.250
C3-A390B.45-50030	02925930	CAT50 ADB	C3	1.181	0.429	1.260	1.260	5.185	2	0	PB	5.730
C3-A390B.45-50060	02925931	CAT50 ADB	C3	2.362	1.610	1.260	1.260	6.366	2	0	PB	5.970
C4-A390B.45-50030	02925948	CAT50 ADB	C4	1.181	0.429	1.575	1.575	5.185	2	0	PB	5.780
C4-A390B.45-50060	02925934	CAT50 ADB	C4	2.362	1.610	1.969	1.575	6.366	2	0	PB	6.610
C5-A390B.45-50030	02925937	CAT50 ADB	C5	1.181	0.429	1.969	1.969	5.185	2	0	PB	5.730
C5-A390B.45-50070	02925938	CAT50 ADB	C5	2.756	2.004	1.969	1.969	6.760	2	0	PB	6.830
C6-A390B.45-50030	02925940	CAT50 ADB	C6	1.181	0.429	2.480	2.480	5.185	2	0	PB	5.530
C6-A390B.45-50080	02925941	CAT50 ADB	C6	3.150	2.398	2.480	2.480	7.154	2	0	PB	7.940
C8-A390B.45-50070	02925942	CAT50 ADB	C8	2.756	2.004	3.150	3.150	6.760	2	0	PB	8.220
C8-A390B.45-50120	02925943	CAT50 ADB	C8	4.724	3.972	3.150	3.150	8.728	2	0	PB	12.240

Akcesoria

Dla wielkości	Klucz przedłużony	Klucz
CAT40/ C3	5680015-05	5680065-13
CAT40/ C4	5680015-05	5680065-10
CAT40/ C5	5680015-01	5680065-11
CAT40/ C6	5680015-01	5680065-12
CAT50/ C3	5680015-05	5680065-13
CAT50/ C4-50030	5680015-05	5680065-10
CAT50/ C4-50060	5680015-05	5680065-10
CAT50/ C5	5680015-01	5680065-11
CAT50/ C6	5680015-02	5680065-12
CAT50/ C8	5680015-02	5680065-12

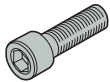
Części zamienne, zawarte w dostawie

Dla wielkości	Śruba centralna	Zaślepka	Nakrętka ustalająca
			
CAT40/ C3	5512063-10	564301701	5512091-04
CAT40/ C4	5512063-07	564301701	5512091-03
CAT40/ C5	5512063-08	564301701	5512091-01
CAT40/ C6	5512063-13	564301701	5512091-02
CAT50/ C3	5512063-10	564301702	5512091-04
CAT50/ C4-50030	5512063-07	564301701	5512091-03
CAT50/ C4-50060	5512063-07	564301702	5512091-03
CAT50/ C5	5512063-08	564301702	5512091-01
CAT50/ C6	5512063-09	564301702	5512091-02
CAT50/ C8	5512063-09	564301702	5512091-02

Akcesoria / Części zamienne

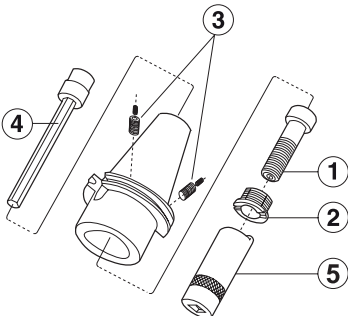

Akcesoria:
4 = Klucz przedłużony
5 = Klucz

Części zamienne:
1 = Śruba centralna
2 = Nakrętka zabezpieczająca
3 = Zaślepki (kołki ustalające)

C 410 – Oprawki HSK-A Seco-Capto™ – ISO 26623-2

HSK-A/ ISO12164-1-HSK-A



Wersja 1

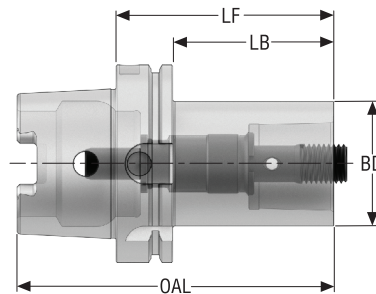

Wersja 2

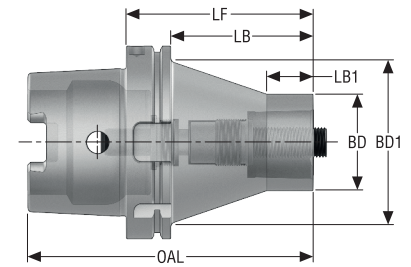

Oznaczenie	Numer produktu	CTMS	CTWS	LF	LB	LB1	BD	BD1	OAL	Wersja	RFID otwór	Wyważenie	Waga
				mm Cal.	mm Cal.	mm Cal.	mm Cal.	mm Cal.	mm Cal.				kg lbs
HA10-C3-032-080	10197961	HSK-A100	C3	80,0 3.150	51,0 2.008	–	32,0 1.260	–	130,0 5.118	1	1	PB	2,5 5.510
HA06-C3-032-075	10197962	HSK-A63	C3	75,0 2.953	49,0 1.929	–	32,0 1.260	–	107,0 4.213	1	1	PB	1,0 2.200
HA10-C4-040-090	10197963	HSK-A100	C4	90,0 3.543	61,0 2.402	–	40,0 1.575	–	140,0 5.512	1	1	PB	2,6 5.730
HA06-C4-040-080	10197964	HSK-A63	C4	80,0 3.150	54,0 2.126	–	40,0 1.575	–	112,0 4.409	1	1	PB	1,2 2.650
HA10-C5-050-100	10197965	HSK-A100	C5	100,0 3.937	71,0 2.795	–	50,0 1.969	–	150,0 5.906	1	1	PB	3,1 6.830
HA06-C5-050-090	10197966	HSK-A63	C5	90,0 3.543	64,0 2.520	–	50,0 1.969	–	122,0 4.803	1	1	PB	3,1 6.830
HA10-C6-063-110	10197967	HSK-A100	C6	110,0 4.331	81,0 3.189	–	63,0 2.480	–	160,0 6.299	1	1	PB	3,8 8.380
HA10-C8-080-120	10197968	HSK-A100	C8	120,0 4.724	91,0 3.583	–	80,0 3.150	–	170,0 6.693	1	1	PB	4,1 9.040
HSKA125-C6-120	03229625	HSK-A125	C6	120,0 4.724	91,0 3.583	–	63,0 2.480	–	183,0 7.205	1	1	PB	5,2 11.460
HSKA125-C6-120-V	03229626	HSK-A125	C6	120,0 4.724	91,0 3.583	30,0 1.181	63,0 2.480	108,0 4.252	183,0 7.205	2	1	PB	6,4 14.110
HSKA125-C8-130	03229627	HSK-A125	C8	130,0 5.118	101,0 3.976	–	80,0 3.150	–	193,0 7.598	1	1	PB	6,5 14.330
HSKA125-C8-130-V	03229628	HSK-A125	C8	130,0 5.118	101,0 3.976	30,0 1.181	80,0 3.150	105,0 4.134	193,0 7.598	2	1	PB	7,8 17.200

Wstęp

Wiercenie

Rozwiercanie

Wytaczanie

Załącznik

Akcesoria

Dla	Klucz przedłużony	Klucz	Klucz
HA10-C3-032-080	5680015-05	5680094-06	5680065-13
HA06-C3-032-075	5680015-05	5680094-04	5680065-13
HA10-C4-040-090	5680015-05	5680094-06	5680065-10
HA06-C4-040-080	5680015-05	5680094-04	5680065-10
HA10-C5-050-100	5680015-01	5680094-06	5680065-11
HA06-C5-050-090	5680015-01	5680094-04	5680065-11
HA10-C6-063-110	5680015-02	5680094-06	5680065-12
HA10-C8-080-120	5680015-02	5680094-06	5680065-12
HSKA125-C6-120	5680015-02	5680094-07	5680065-12
HSKA125-C6-120-V	5680015-02	5680094-07	5680065-12
HSKA125-C8-130	5680015-02	5680094-07	5680065-12
HSKA125-C8-130-V	5680015-02	5680094-07	5680065-12

Części zamienne, zawarte w dostawie

Dla	Śruba centralna	Przewód do chłodziwa	Nakrętka ustalająca
HA06-C3-032-075	5512067-01	5692020-04	5512091-04
HA06-C4-040-080	5512067-02	5692020-04	5512091-03
HA06-C5-050-090	5512067-03	5692020-04	5512091-01
HA10-C3-032-080	5512067-01	5692020-06	5512091-04
HA10-C4-040-090	5512067-02	5692020-06	5512091-03
HA10-C5-050-100	5512067-03	5692020-06	5512091-01
HA10-C6-063-110	5512067-04	5692020-06	5512091-02
HA10-C8-080-120	5512067-04	5692020-06	5512091-02
HSKA125-C6-120	5512063-09	5692020-07	5512091-02
HSKA125-C6-120-V	5512063-09	5692020-07	5512091-02
HSKA125-C8-130	5512063-09	5692020-07	5512091-02
HSKA125-C8-130-V	5512063-09	5692020-07	5512091-02

Akcesoria / Części zamienne

Akcesoria:
 2 = Klucz przedłużony
 4 = Klucz
 6 = Klucz do przewodów chłodzących

Części zamienne:
 1 = Śruba centralna
 3 = Nakrętka zabezpieczająca
 5 = Przewód na chłodziwo*

*Przewody do chłodziwa są dostarczane z każdą oprawką HSK-A na Seco-Capto™

C 411 – Oprawki HSK-T Seco-Capto™ – ISO 26623-2

HSK-T/ ISO12164-3-HSK-T

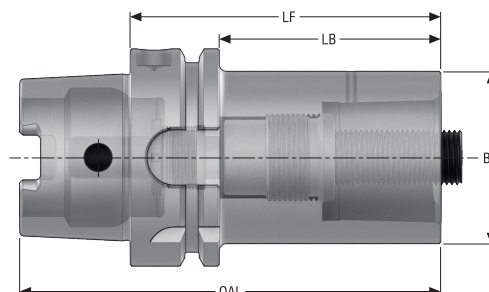

Oznaczenie	Numer produktu	CTMS	CTWS	LF	LB	BD	OAL	RFID otwór	Wyważenie	Waga
				mm Cal.	mm Cal.	mm Cal.	mm Cal.			kg lbs
C4-390.411-63080	02786511	HSK-T63	C4	80,0 3.150	54,0 2.126	40,0 1.575	112,0 4.409	1	-	1,0 2.200
C5-390.411-63090	02786520	HSK-T63	C5	90,0 3.543	64,0 2.520	50,0 1.969	122,0 4.803	1	-	1,3 2.870
C4-390.411-100090	02786519	HSK-T100	C4	90,0 3.543	61,0 2.402	40,0 1.575	140,0 5.512	1	-	2,4 5.290
C5-390.411-100100	02786521	HSK-T100	C5	100,0 3.937	71,0 2.795	50,0 1.969	150,0 5.906	1	-	2,7 5.950
C6-390.411-100110	02786522	HSK-T100	C6	110,0 4.331	81,0 3.189	63,0 2.480	160,0 6.299	1	-	3,3 7.280
C8-390.411-100120	02786523	HSK-T100	C8	120,0 4.724	91,0 3.583	80,0 3.150	170,0 6.693	1	-	4,5 9.920

Akcesoria

Dł.	Klucz przedłużony	Klucz	Klucz
C4-390.411-63080	5680015-05	5680094-04	5680065-10
C5-390.411-63090	5680015-01	5680094-04	5680065-11
C4-390.411-100090	5680015-05	5680094-06	5680065-10
C5-390.411-100100	5680015-01	5680094-06	5680065-11
C6-390.411-100110	5680015-02	5680094-06	5680065-12
C8-390.411-100120	5680015-02	5680094-06	5680065-12

Części zamienne, zawarte w dostawie

Dł.	Śruba centralna	Przewód do chłodziwa	Nakrętka ustalająca
C4-390.411-100090	5512063-07	20E9306	5512091-03
C4-390.411-63080	5512063-07	5692020-04	5512091-03
C5-390.411-100100	5512063-08	20E9306	5512091-01
C5-390.411-63090	5512063-08	5692020-04	5512091-01
C6-390.411-100110	5512063-09	5692020-06	5512091-02
C8-390.411-100120	5512063-09	5692020-06	5512091-02

Akcesoria / Części zamienne

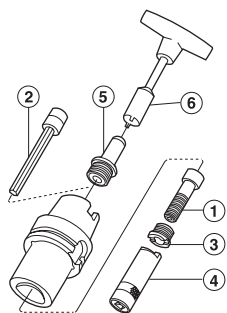

Akcesoria:

- 2 = Klucz przedłużony
- 4 = Klucz
- 6 = Klucz do przewodów chłodzących

Części zamienne:

- 1 = Śruba centralna
- 3 = Nakrętka zabezpieczająca
- 5 = Przewód na chłodziwo*

*Przewody do chłodziwa są dostarczane z każdą oprawką HSK-A na Seco-Capto™

C 140 – Oprawki DIN Seco-Capto™ – ISO 26623-2 DIN 69871-ADB

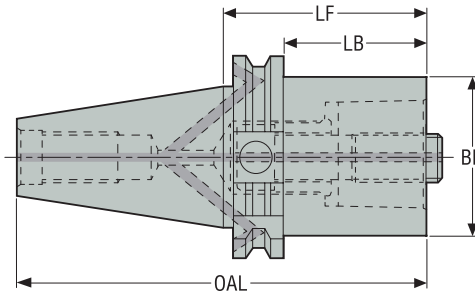

Oznaczenie	Numer produktu	CTMS	CTWS	LF	LB	BD	OAL	RFID otwór	Wywa- żenie	Waga
				mm Cal.	mm Cal.	mm Cal.	mm Cal.			kg lbs
C3-390B.140-40030	02924104	DIN40 ADB	C3	30,0 1.181	10,9 0.429	32,0 1.260	98,4 3.874	0	PB	0,8 1.760
C3-390B.140-40060	02924105	DIN40 ADB	C3	60,0 2.362	40,9 1.610	32,0 1.260	128,4 5.055	0	PB	0,9 1.980
C4-390B.140-40030	02924108	DIN40 ADB	C4	30,0 1.181	10,9 0.429	40,0 1.575	98,4 3.874	0	PB	0,8 1.760
C4-390B.140-40060	02924109	DIN40 ADB	C4	60,0 2.362	40,9 1.610	40,0 1.575	128,4 5.055	0	PB	1,1 2.430
C5-390B.140-40040	02924112	DIN40 ADB	C5	40,0 1.575	20,9 0.823	50,0 1.969	108,4 4.268	0	PB	0,9 1.980
C5-390B.140-40080	02924113	DIN40 ADB	C5	80,0 3.150	60,9 2.398	50,0 1.969	148,4 5.843	0	PB	1,5 3.310
C6-390B.140-40085	02924116	DIN40 ADB	C6	85,0 3.346	65,9 2.594	63,0 2.480	153,4 6.039	0	PB	1,8 3.970
C3-390B.140-50030	02924106	DIN50 ADB	C3	30,0 1.181	10,9 0.429	32,0 1.260	131,7 5.185	0	PB	2,6 5.730
C3-390B.140-50060	02924107	DIN50 ADB	C3	60,0 2.362	40,9 1.610	32,0 1.260	161,7 6.366	0	PB	2,7 5.950
C4-390B.140-50030	02924110	DIN50 ADB	C4	30,0 1.181	10,9 0.429	40,0 1.575	131,7 5.185	0	PB	2,6 5.730
C4-390B.140-50060	02924111	DIN50 ADB	C4	60,0 2.362	40,9 1.610	40,0 1.575	161,7 6.366	0	PB	2,8 6.170
C5-390B.140-50030	02924114	DIN50 ADB	C5	30,0 1.181	10,9 0.429	50,0 1.969	131,7 5.185	0	PB	2,6 5.730
C5-390B.140-50070	02924115	DIN50 ADB	C5	70,0 2.756	50,9 2.004	50,0 1.969	171,7 6.760	0	PB	3,1 6.830
C6-390B.140-50030	02924117	DIN50 ADB	C6	30,0 1.181	10,9 0.429	63,0 2.480	131,7 5.185	0	PB	2,5 5.510
C6-390B.140-50080	02924118	DIN50 ADB	C6	80,0 3.150	60,9 2.398	63,0 2.480	181,7 7.154	0	PB	3,6 7.940
C8-390B.140-50070	02924119	DIN50 ADB	C8	70,0 2.756	50,9 2.004	80,0 3.150	171,7 6.760	0	PB	3,7 8.160
C8-390B.140-50120	02924120	DIN50 ADB	C8	120,0 4.724	100,9 3.972	80,0 3.150	221,7 8.728	0	PB	5,6 12.350

Wstęp

Wiercenie

Rozwiercanie

Wytaczanie

Załącznik

Akcesoria

Dł	Klucz przedłużony	Klucz
C3-400	5680015-05	5680065-13
C4-400	5680015-05	5680065-10
C5-400	5680015-01	5680065-11
C6-400	5680015-01	5680065-12
C3-500	5680015-05	5680065-13
C4-500	5680015-05	5680065-10
C5-500	5680015-01	5680065-11
C6-500	5680015-02	5680065-12
C8	5680015-02	5680065-12

Części zamienne, zawarte w dostawie

Dł	Śruba centralna	Zaślepka	Nakrętka ustalająca
C3-400	5512063-10	564301701	5512091-04
C3-500	5512063-10	564301702	5512091-04
C4-400	5512063-07	564301701	5512091-03
C4-500	5512063-07	564301702	5512091-03
C5-400	5512063-08	564301701	5512091-01
C5-500	5512063-08	564301702	5512091-01
C6-400	5512063-13	564301701	5512091-02
C6-500	5512063-09	564301702	5512091-02
C8	5512063-09	564301702	5512091-02

Akcesoria / Części zamienne

Akcesoria:
4 = Klucz przedłużony
5 = Klucz

Części zamienne:
1 = Śruba centralna
2 = Nakrętka zabezpieczająca
3 = Zaślepki (kołki ustalające)

C 5191 – Oprawki Seco-Capto™ – ISO 26623-2

Oprawki DIN stożek-czoło-ADB



Wersja 1

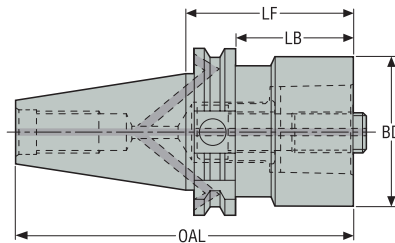

Wersja 2

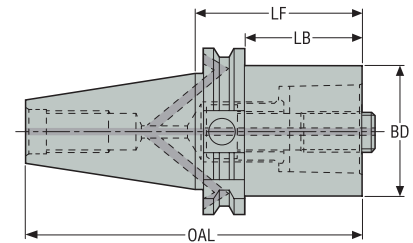

Oznaczenie	Numer produktu	CTMS	CTWS	LF	LB	BD	OAL	Wersja	RFID otwór	Wyważenie	Waga
				mm Cal.	mm Cal.	mm Cal.	mm Cal.				kg lbs
E316951915050	03030258	DIN40 TF ADB	C5	50,0 1.969	30,9 1.217	50,0 1.969	118,4 4.661	2	1	PB	1,1 2.430
E317151915070	03030264	DIN50 TF ADB	C5	70,0 2.756	50,9 2.004	50,0 1.969	171,7 6.760	2	1	PB	3,15 6.940
E317151916350	03030262	DIN50 TF ADB	C6	50,0 1.969	30,9 1.217	63,0 2.480	151,7 5.972	2	0	-	2,4 5.290
E3171519163100	03030265	DIN50 TF ADB	C6	100,0 3.937	80,9 3.185	63,0 2.480	201,7 7.941	2	1	PB	4,08 8.990
E317151918070	03030263	DIN50 TF ADB	C8	70,0 2.756	50,9 2.004	80,0 3.150	171,7 6.760	2	0	-	3,9 8.600
E3171519180120	03030266	DIN50 TF ADB	C8	120,0 4.724	100,9 3.972	80,0 3.150	221,7 8.728	2	0	-	5,62 12.390

Akcesoria

Dł.	Klucz przedłużony	Klucz
DIN40 TF/ C5	5680015-01	5680065-11
DIN50 TF/ C5	5680015-01	5680065-11
DIN50 TF/ C6-C8	5680015-02	5680065-12

Części zamienne, zawarte w dostawie

Dł.	Śruba centralna	Zasłepka	Nakrętka ustalająca
DIN40 TF/ C5	5512063-08	564301701	5512091-01
DIN50 TF/ C5	5512063-08	564301702	5512091-01
DIN50 TF/ C6-C8	5512063-09	564301702	5512091-02

Wstęp

Wiercenie

Rozwiercanie

Wytaczanie

Załącznik

Akcesoria / Części zamienne

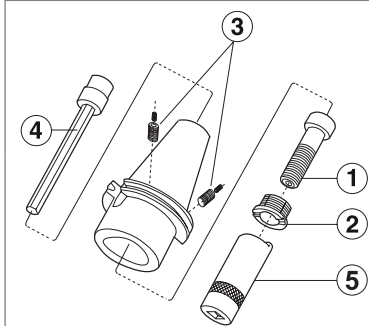

Akcesoria:

- 4 = Klucz przedłużony
- 5 = Klucz

Części zamienne:

- 1 = Śruba centralna
- 2 = Nakrętka zabezpieczająca
- 3 = Zaślepki (kołki ustalające)

C 55/58 – Oprawki BT Seco-Capto™ – ISO 26623-2

BT



Wersja 1

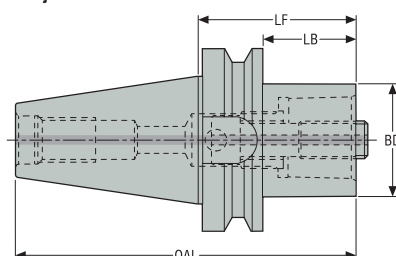

Wersja 2

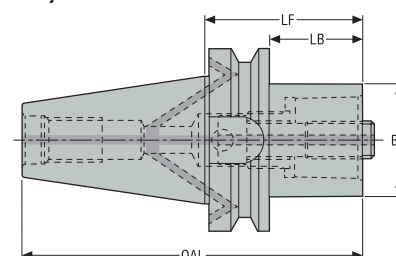

Oznaczenie	Numer produktu	CTMS	CTWS	LF	LB	BD	OAL	Wersja	RFID otwór	Wyważenie	Waga
				mm Cal.	mm Cal.	mm Cal.	mm Cal.				kg lbs
C3-390.55-30030	75039807	BT30 AD	C3	30,0 1.181	8,0 0.315	32,0 1.260	78,4 3.087	1	0	PB	0,53 1.170
C3-390.55-30060	75039808	BT30 AD	C3	60,0 2.362	38,0 1.496	32,0 1.260	108,4 4.268	1	0	PB	0,73 1.610
C3-390B.55-40030	02925959	BT40 ADB	C3	30,0 1.181	3,0 0.118	32,0 1.260	95,4 3.756	2	0	PB	0,9 1.980
C3-390B.55-40060	02925960	BT40 ADB	C3	60,0 2.362	33,0 1.299	32,0 1.260	125,4 4.937	2	0	PB	1,1 2.430
C4-390B.55-40030	02925963	BT40 ADB	C4	30,0 1.181	3,0 0.118	40,0 1.575	95,4 3.756	2	0	PB	0,9 1.980
C4-390B.55-40060	02925964	BT40 ADB	C4	60,0 2.362	33,0 1.299	40,0 1.575	125,4 4.937	2	0	PB	1,2 2.650
C5-390B.55-40050	02925967	BT40 ADB	C5	50,0 1.969	23,0 0.906	50,0 1.969	115,4 4.543	2	0	PB	1,1 2.430
C5-390B.55-40090	02925968	BT40 ADB	C5	90,0 3.543	63,0 2.480	50,0 1.969	155,4 6.118	2	0	PB	1,7 3.750
C6-390B.55-40075	02925971	BT40 ADB	C6	75,0 2.953	54,6 2.150	63,0 2.480	140,4 5.528	2	0	PB	1,7 3.750
C3-390B.58-50040	02925961	BT50 ADB	C3	40,0 1.575	2,0 0.079	32,0 1.260	141,8 5.583	2	0	PB	3,5 7.720
C3-390B.58-50070	02925962	BT50 ADB	C3	70,0 2.756	32,0 1.260	32,0 1.260	171,8 6.764	2	0	PB	3,7 8.160
C4-390B.58-50040	02925965	BT50 ADB	C4	40,0 1.575	2,0 0.079	40,0 1.575	141,8 5.583	2	0	PB	3,5 7.720
C4-390B.58-50070	02925966	BT50 ADB	C4	70,0 2.756	32,0 1.260	40,0 1.575	171,8 6.764	2	0	PB	3,8 8.380
C5-390B.58-50040	02925969	BT50 ADB	C5	40,0 1.575	2,0 0.079	50,0 1.969	141,8 5.583	2	0	PB	3,4 7.500
C5-390B.58-50080	02925970	BT50 ADB	C5	80,0 3.150	42,0 1.654	50,0 1.969	181,8 7.157	2	0	PB	4,0 8.820
C6-390B.58-50050	02925972	BT50 ADB	C6	50,0 1.969	12,0 0.472	63,0 2.480	151,8 5.976	2	0	PB	3,5 7.720
C6-390B.58-50100	02925973	BT50 ADB	C6	100,0 3.937	62,0 2.441	63,0 2.480	201,8 7.945	2	0	PB	4,6 10.140
C8-390B.58-50070	02925974	BT50 ADB	C8	70,0 2.756	32,0 1.260	80,0 3.150	171,8 6.764	2	0	PB	4,0 8.820
C8-390B.58-50120	02925975	BT50 ADB	C8	120,0 4.724	82,0 3.228	80,0 3.150	221,8 8.732	2	0	PB	5,9 13.010

Wstęp

Wiercenie

Rozwiercanie

Wytaczanie

Załącznik

Akcesoria

Dł.	Klucz przedłużony	Klucz
C3-390.55	5680015-05	5680065-13
C3-390B.55	5680015-05	5680065-13
C4-390B.55	5680015-05	5680065-10
C5-390B.55	5680015-01	5680065-11
C6-390B.55	5680015-01	5680065-12
C3-390B.58	5680015-05	5680065-13
C4-390B.58	5680015-05	5680065-10
C5-390B.58	5680015-01	5680065-11
C6-390B.58	5680015-02	5680065-12
C8	5680015-02	5680065-12

Części zamienne, zawarte w dostawie

Dł.	Śruba centralna	Zaślepka	Nakrętka ustalająca
C3-390.55	5512063-10	-	5512091-04
C3-390B.55	5512063-10	564301701	5512091-04
C3-390B.58	5512063-10	564301702	5512091-04
C4-390B.55	5512063-07	564301701	5512091-03
C4-390B.58	5512063-07	564301702	5512091-03
C5-390B.55	5512063-08	564301701	5512091-01
C5-390B.58	5512063-08	564301702	5512091-01
C6-390B.55	5512063-13	564301701	5512091-02
C6-390B.58	5512063-09	564301702	5512091-02
C8	5512063-09	564301702	5512091-02

Akcesoria / Części zamienne

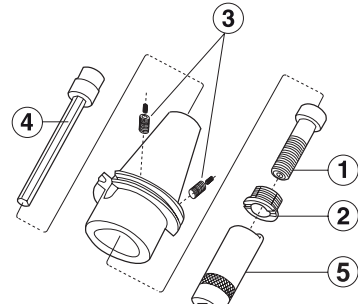

Akcesoria:
4 = Klucz przedłużony
5 = Klucz

Części zamienne:
1 = Śruba centralna
2 = Nakrętka zabezpieczająca
3 = Zaślepki (kołki ustalające)

Wstęp

Wiercenie

Rozwiercanie

Wytaczanie

Załącznik

C 605 – Oprawki BT Mazak Seco-Capto™ – ISO 26623-2

BT Mazak

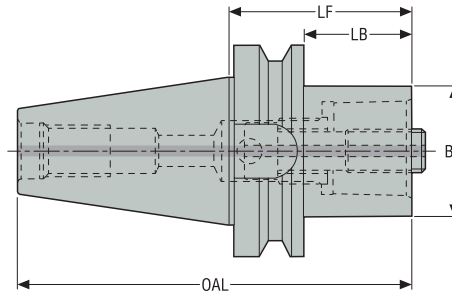
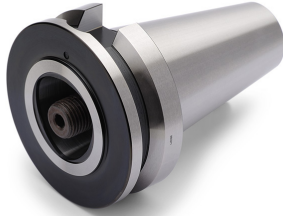

- Konstrukcja Mazak oznacza obrót o 90° gniazda Seco-Capto™ w porównaniu z klasycznymi oprawkami podstawowymi BT
- Dla e-obrabiarek Mazak

Oznaczenie	Numer produktu	CTMS	CTWS	LF	LB	BD	OAL	RFID otwór	Wyważenie	Waga
				mm Cal.	mm Cal.	mm Cal.	mm Cal.			kg lbs
C5-390.605-40030	02606358	BT40 AD Mazak	C5	30,0 1.181	3,0 0.118	50,0 1.969	95,4 3.756	0	-	1,1 2.430
C6-390.605-50040	02606354	BT50 AD Mazak	C6	40,0 1.575	2,0 0.079	63,0 2.480	141,8 5.583	0	-	3,3 7.280
C8-390.605-50070	02646032	BT50 AD Mazak	C8	70,0 2.756	70,0 2.756	80,0 3.150	171,8 6.764	0	-	4,1 9.040

Akcesoria

Dla wielkości	Klucz przedłużony	Klucz
C5	5680015-01	5680065-11
C6	5680015-02	5680065-12
C8	5680015-02	5680065-12

Części zamienne, zawarte w dostawie

Dla wielkości	Śruba centralna	Nakrętka ustalająca
C5	5512063-08	5512091-01
C6	5512063-09	5512091-02
C8	5512063-09	5512091-02

Akcesoria / Części zamienne

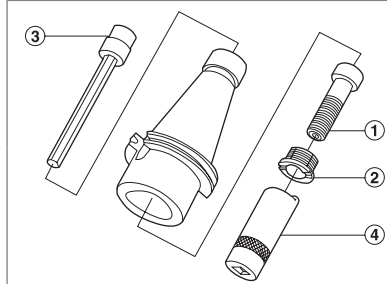

Akcesoria:

3 = Klucz przedłużony

4 = Klucz

Części zamienne:

1 = Śruba centralna

2 = Nakrętka zabezpieczająca

C 5191 – Oprawki Seco-Capto™ – ISO 26623-2

Oprawki BT stożek-czoło-AD/ADB



Wersja 1

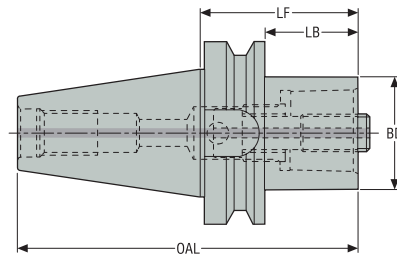

Wersja 2

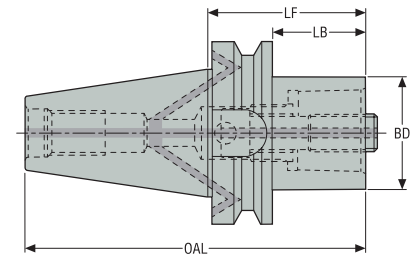

Oznaczenie	Numer produktu	CTMS	CTWS	LF	LB	BD	OAL	Wersja	RFID otwór	Wyważenie	Waga
				mm Cal.	mm Cal.	mm Cal.	mm Cal.				kg lbs
E400251913240	03030234	BT30 TF AD	C3	40,0 1.575	22,0 0.866	32,0 1.260	88,4 3.480	1	1	PB	0,454 1.000
E400251914060	03030235	BT30 TF AD	C4	60,0 2.362	22,0 0.866	40,0 1.575	108,4 4.268	1	1	PB	0,651 1.440
E311451914040	03030236	BT40 TF ADB	C4	40,0 1.575	13,0 0.512	40,0 1.575	105,4 4.150	2	0	PB	1,1 2.430
E311451915050	03030237	BT40 TF ADB	C5	50,0 1.969	23,0 0.906	50,0 1.969	115,4 4.543	2	0	PB	1,2 2.650
E311451916375	03030238	BT40 TF ADB	C6	75,0 2.953	48,0 1.890	63,0 2.480	140,4 5.528	2	0	PB	1,7 3.750
E311651914040	03030239	BT50 TF ADB	C4	40,0 1.575	2,0 0.079	50,0 1.969	141,8 5.583	2	1	PB	3,6 7.940
E311651915040	03030240	BT50 TF ADB	C5	40,0 1.575	2,0 0.079	50,0 1.969	141,8 5.583	2	0	PB	3,5 7.720
E311651916350	03030241	BT50 TF ADB	C6	50,0 1.969	12,0 0.472	63,0 2.480	151,8 5.976	2	0	PB	3,6 7.940
E3116519163100	03030242	BT50 TF ADB	C6	100,0 3.937	62,0 2.441	63,0 2.480	201,8 7.945	2	0	PB	4,63 10.210
E311651918070	03030243	BT50 TF ADB	C8	70,0 2.756	32,0 1.260	80,0 3.150	171,8 6.764	2	0	PB	4,2 9.260
E3116519180120	03030244	BT50 TF ADB	C8	120,0 4.724	82,0 3.228	80,0 3.150	121,8 4.795	2	1	PB	5,91 13.030

Akcesoria

Stożek/ wielkość	Klucz przedłużony	Klucz
BT30 TF/ C3	5680015-05	5680065-13
BT30 TF/ C4	5680015-05	5680065-10
BT40 TF/ C4	5680015-05	5680065-10
BT40 TF/ C5	5680015-01	5680065-11
BT40 TF/ C6	5680015-01	5680065-12
BT50 TF/ C4	5680015-05	5680065-10
BT50 TF/ C5	5680015-01	5680065-11
BT50 TF/ C6-C8	5680015-02	5680065-12

Wstęp



Wiercenie

Rozwiercanie

Wytaczanie

Załącznik

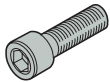
Części zamienne, zawarte w dostawie

Stożek/ wielkość	Śruba centralna	Zaślepka	Nakrętka ustalająca
		 1x	
BT30 TF/ C3	5512063-10	-	5512091-04
BT30 TF/ C4	5512063-07	-	5512091-03
BT40 TF/ C4	5512063-07	564301701	5512091-03
BT40 TF/ C5	5512063-08	564301701	5512091-01
BT40 TF/ C6	5512063-13	564301701	5512091-02
BT50 TF/ C4	5512063-07	564301702	5512091-03
BT50 TF/ C5	5512063-08	564301702	5512091-01
BT50 TF/ C6-C8	5512063-09	564301702	5512091-02

Akcesoria / Części zamienne

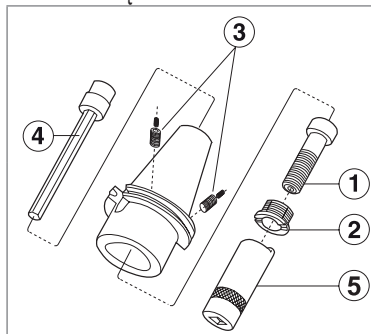

Akcesoria:
4 = Klucz przedłużony
5 = Klucz

Części zamienne:
1 = Śruba centralna
2 = Nakrętka zabezpieczająca
3 = Zaślepki (kołki ustalające)

C 5191 – Oprawki Seco-Capto™

CAT TF / ASME B5.50-1994-ADB



Wersja 1

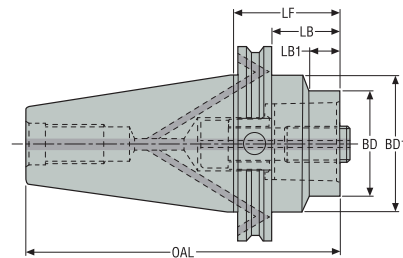

Wersja 2

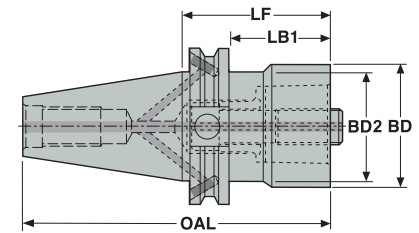

Oznaczenie	Numer produktu	CTMS	CTWS	LF	LB	LB1	BD	BD1	OAL	Wersja	RFID otwór	Wyważenie	Waga
				Cal.	Cal.	Cal.	Cal.	Cal.	Cal.				lbs
E234251915050	03030247	CAT40 TF ADB	C5	1.969	1.220	1.220	1.969	1.750	4.660	2	1	PB	2.250
E234451914040	03030249	CAT50 TF ADB	C4	1.575	0.090	0.090	1.575	2.750	5.580	1	1	PB	6.830
E234451915040	03030250	CAT50 TF ADB	C5	1.575	0.090	0.090	1.969	2.750	5.580	1	0	-	6.390
E234451916340	03030251	CAT50 TF ADB	C6	1.575	0.120	0.120	2.480	2.750	5.580	1	0	-	6.390
E234451916390	03030252	CAT50 TF ADB	C6	3.543	2.085	2.085	2.480	2.750	7.543	1	0	-	8.660
E2344519180100	03030253	CAT50 TF ADB	C8	3.937	3.185	3.185	3.150	2.750	7.937	2	1	PB	9.040

Aksesoria

Stożek/ wielkość	Klucz przedłużony	Klucz
CAT40/ C5	5680015-01	5680065-11
CAT50/ C4	5680015-05	5680065-10
CAT50/ C5	5680015-01	5680065-11
CAT50/ C6	5680015-02	5680065-12
CAT50/ C8	5680015-02	5680065-12

Części zamienne, zawarte w dostawie

Stożek/ wielkość	Śruba centralna	Zaślepka	Nakrętka ustalająca
CAT40/ C5	5512063-08	564301701	5512091-01
CAT50/ C4	5512063-07	564301702	5512091-03
CAT50/ C5	5512063-08	564301702	5512091-01
CAT50/ C6	5512063-09	564301702	5512091-02
CAT50/ C8	5512063-09	564301702	5512091-02

Akcesoria / Części zamienne

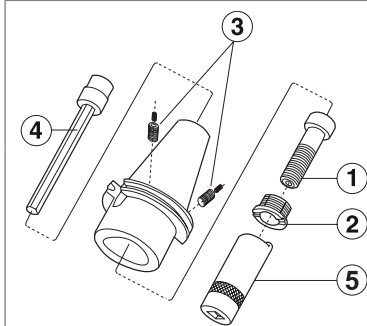

Akcesoria:

- 4 = Klucz przedłużony
- 5 = Klucz

Części zamienne:

- 1 = Śruba centralna
- 2 = Nakrętka zabezpieczająca
- 3 = Zasłepki (kolki ustalające)

C 5191 – Oprawki Seco-Capto™

Serie CAT TF Mazak™ e-machine oraz Mori Seiki NT™

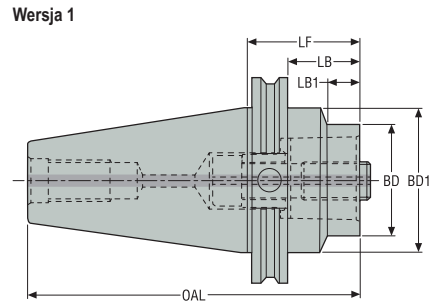

- Gniazdo poligonalne obrócone o 90° zapewnia precyzyjną kontrolę ostrza

Oznaczenie	Numer produktu	CTMS	CTWS	LF	LB	LB1	BD	BD1	OAL	Wersja	RFID otwór	Wyważenie	Waga
E947451916350	03030255	CAT50 TF AD Mazak	C6	Cal.	Cal.	Cal.	Cal.	Cal.	Cal.	1	0	PB	lbs
				1.969	0.510	0.510	2.480	2.750	5.960				6.830

Akcesoria

Dla wielkości	Klucz przedłużony	Klucz
E947451916350	5680015-02	5680065-12

Części zamienne, zawarte w dostawie

Dla wielkości	Śruba centralna	Nakrętka ustalająca
E947451916350	5512063-09	5512091-02

Akcesoria / Części zamienne

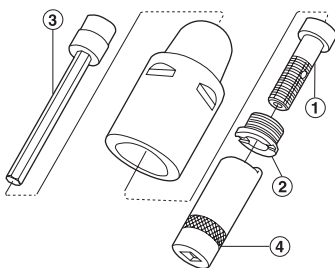

Akcesoria:
3 = Klucz przedłużony
4 = Klucz do nakrętki zabezpieczającej

Części zamienne:
1 = Śruba centralna
2 = Nakrętka zabezpieczająca

C 01 – Przedłużki Seco-Capto™
ISO 26623-1

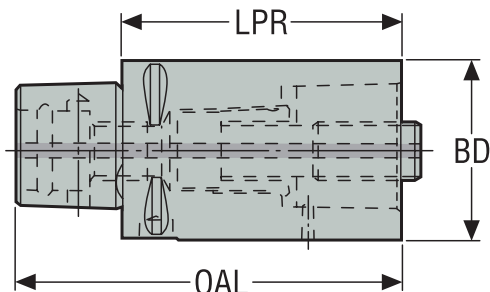

Oznaczenie	Numer produktu	CTMS	CTWS	LPR	BD	OAL	RFID otwór	Wywa- żenie	Waga
				mm Cal.	mm Cal.	mm Cal.			kg lbs
C3-391.01-32060A	75039884	C3	C3	60,0 2.362	32,0 1.260	79,0 3.110	0	-	0,34 0.750
C3-391.01-32080A	00090847	C3	C3	80,0 3.150	32,0 1.260	99,0 3.898	0	-	0,5 1.100
C4-391.01-40060A	75039885	C4	C4	60,0 2.362	40,0 1.575	84,0 3.307	0	-	0,54 1.190
C4-391.01-40080A	02207391	C4	C4	80,0 3.150	40,0 1.575	104,0 4.094	0	-	0,71 1.570
C5-391.01-50080A	75039886	C5	C5	80,0 3.150	50,0 1.969	110,0 4.331	0	-	1,12 2.470
C5-391.01-50100A	00004773	C5	C5	100,0 3.937	50,0 1.969	130,0 5.118	0	-	1,39 3.060
C6-391.01-63100A	75039887	C6	C6	100,0 3.937	63,0 2.480	138,0 5.433	0	-	2,2 4.850
C6-391.01-63140A	00004840	C6	C6	140,0 5.512	63,0 2.480	178,0 7.008	0	-	3,1 6.830
C8-391.01-80100A	75039888	C8	C8	100,0 3.937	80,0 3.150	148,0 5.827	0	-	3,62 7.980
C8-391.01-80125A	00004841	C8	C8	125,0 4.921	80,0 3.150	173,0 6.811	0	-	4,54 10.010

Akcesoria

Dla wiel- kości	Klucz przedłużony	Klucz
C3	5680015-05	5680065-13
C4	5680015-05	5680065-10
C5	5680015-01	5680065-11
C6	5680015-02	5680065-12
C8	5680015-02	5680065-12

Części zamienne, zawarte w dostawie

Dla wielkości	Śruba centralna	Nakrętka ustalająca
C3	5512067-01	5512091-04
C4	5512067-02	5512091-03
C5	5512067-03	5512091-01
C6	5512067-04	5512091-02
C8	5512067-04	5512091-02

Akcesoria / Części zamienne

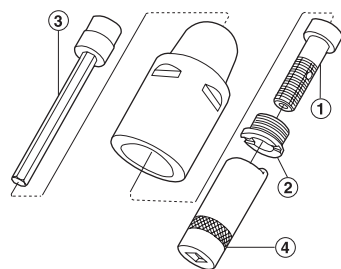

Akcesoria:

- 3 = Klucz przedłużony
- 4 = Klucz do nakrętki zabezpieczającej

Części zamienne:

- 1 = Śruba centralna
- 2 = Nakrętka zabezpieczająca

C 02 – Redukcje Seco-Capto™

ISO 26623-1

Wersja 1

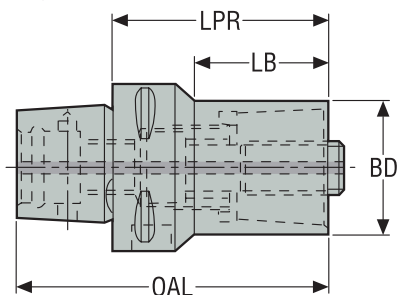

Wersja 2

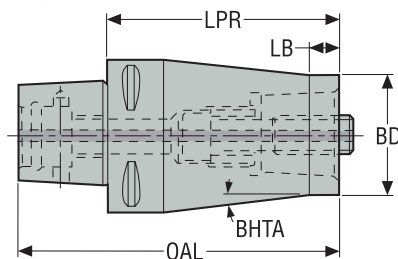

Oznaczenie	Numer produktu	CTMS	CTWS	LPR	LB	BD	OAL	Wersja	BHTA*	RFID otwór	Wyważenie	Waga
				mm Cal.	mm Cal.	mm Cal.	mm Cal.					kg lbs
C4-391.02-32055A	75039889	C4	C3	55,0 2.165	31,0 1.220	32,0 1.260	79,0 3.110	1	-	0	-	0,42 0.930
C4-391.02-32070A	02535687	C4	C3	70,0 2.756	-	32,0 1.260	94,0 3.701	2	6,0	0	-	0,56 1.230
C5-391.02-32060A	75039890	C5	C3	60,0 2.362	34,8 1.370	32,0 1.260	90,0 3.543	1	-	0	-	0,64 1.410
C5-391.02-40065A	75039891	C5	C4	65,0 2.559	40,0 1.575	40,0 1.575	95,0 3.740	1	-	0	-	0,77 1.700
C6-391.02-32070A	75039892	C6	C3	70,0 2.756	39,0 1.535	32,0 1.260	108,0 4.252	1	-	0	-	1,06 2.340
C6-391.02-40080A	75039893	C6	C4	80,0 3.150	51,4 2.024	40,0 1.575	118,0 4.646	1	-	0	-	1,24 2.730
C6-391.02-50080A	75039894	C6	C5	80,0 3.150	51,5 2.028	50,0 1.969	118,0 4.646	1	-	0	-	1,45 3.200
C6-391.02-50110A	02207400	C6	C5	110,0 4.331	12,0 0.472	50,0 1.969	148,0 5.827	2	4,5	0	-	2,15 4.740
C8-391.02-32060B	03080008	C8	C3	60,0 2.362	20,7 0.815	32,0 1.260	108,0 4.252	1	-	0	-	2,0 4.410
C8-391.02-40070B	03080009	C8	C4	70,0 2.756	31,4 1.236	40,0 1.575	118,0 4.646	1	-	0	-	2,1 4.630
C8-391.02-50080B	03080011	C8	C5	80,0 3.150	42,8 1.685	50,0 1.969	128,0 5.039	1	-	0	-	2,4 5.290
C8-391.02-63080B	02527212	C8	C6	80,0 3.150	44,5 1.752	63,0 2.480	128,0 5.039	1	-	0	-	2,6 5.730
C8-391.02-63120A	02207176	C8	C6	120,0 4.724	12,0 0.472	63,0 2.480	168,0 6.614	2	6,0	0	-	3,96 8.730

Akcesoria

Dla wielkości

Klucz przedłużony

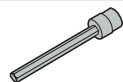

Klucz

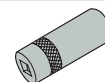

C...-32

5680015-05

5680065-13

C...-40

5680015-05

5680065-10

C...-50

5680015-01

5680065-11

C...-63

5680015-02

5680065-12

Części zamienne, zawarte w dostawie

Dla wielkości	Śruba centralna	Nakrętka ustalająca
C...-32	5512067-01	5512091-04
C...-40	5512067-02	5512091-03
C...-50	5512067-03	5512091-01
C...-63	5512067-04	5512091-02

Akcesoria / Części zamienne

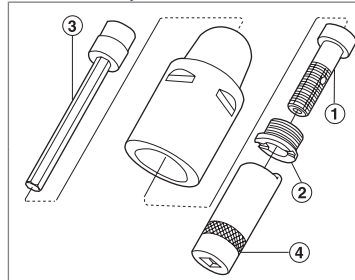

Akcesoria:

- 3 = Klucz przedłużony
- 4 = Klucz do nakrętki zabezpieczającej

Części zamienne:

- 1 = Śruba centralna
- 2 = Nakrętka zabezpieczająca

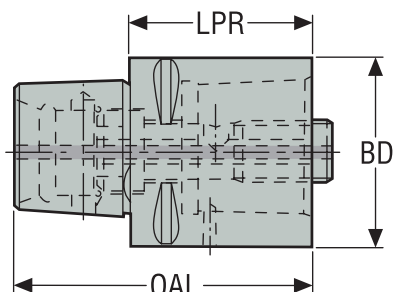
C01 Przedłużki Seco-Capto™, wersja krótka, tylko mocowanie tulejką segmentową
ISO 26623-1

- Oprawki z gniazdem Seco-Capto™ po stronie obrabiarki mogą być mocowane we wrzecionach tulejką segmentową (nie śrubą centralną)

Oznaczenie	Numer produktu	CTMS	CTWS	LPR	BD	OAL	RFID otwór	Wyważenie	Waga
				mm Cal.	mm Cal.	mm Cal.			kg lbs
C3-391.01-32035	02535685	C3	C3	35,0 1.378	32,0 1.260	54,0 2.126	0	-	0,21 0.460
C4-391.01-40040	02535686	C4	C4	40,0 1.575	40,0 1.575	64,0 2.520	0	-	0,37 0.820
C5-391.01-50050	02484934	C5	C5	50,0 1.969	50,0 1.969	80,0 3.150	0	-	0,7 1.540
C6-391.01-63060	02300834	C6	C6	60,0 2.362	63,0 2.480	98,0 3.858	0	-	1,31 2.890
C8-391.01-80065	02417041	C8	C8	65,0 2.559	80,0 3.150	113,0 4.449	0	-	2,3 5.070

Akcesoria

Dla	Klucz przedłużony
C3-391.01-32035	5680015-05
C4-391.01-40040	5680015-05
C5-391.01-50050	5680015-05
C6-391.01-63060	5680015-02
C8-391.01-80065	5680015-02

Części zamienne, zawarte w dostawie

Dla	Śruba centralna	Pierścień zabezpiecz.
C3-391.01-32035	5512068-01	5545040-02
C4-391.01-40040	5512068-02	5545040-03
C5-391.01-50050	5512068-03	5545040-07
C6-391.01-63060	5512068-04	5545040-08
C8-391.01-80065	5512068-05	5545040-08

Akcesoria / Części zamienne

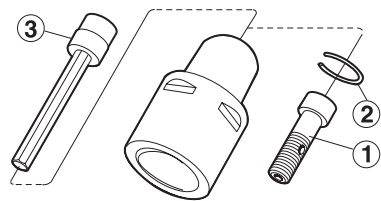

Akcesoria:
3 = Klucz przedłużony

Części zamienne:
1 = Śruba centralna
2 = Pierścień zabezpieczający

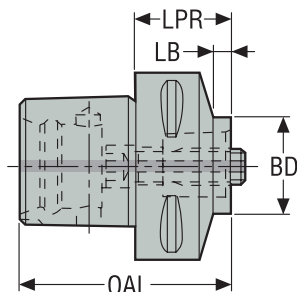
C02 Redukcje Seco-Capto™, wersja krótka, tylko mocowanie tulejką segmentową
ISO 26623-1

- Redukcje z gniazdem Seco-Capto™ po stronie obrabiarki mogą być mocowane we wrzecionach tulejką segmentową (nie ze śrubą centralną)
- * Strona detalu obrócona o 180° w stosunku do strony od obrabiarki

Oznaczenie	Numer produktu	CTMS	CTWS	LPR	LB	BD	OAL	*	RFID otwór	Wywa- żenie	Waga
				mm Cal.	mm Cal.	mm Cal.	mm Cal.				kg lbs
C5-391.02-32033A	03080025	C5	C3	33,0 1.299	5,0 0.197	32,0 1.260	63,0 2.480	-	0	PB	0,6 1.320
C5-391.02-40040A	03079983	C5	C4	40,0 1.575	15,0 0.591	40,0 1.575	70,0 2.756	-	0	-	0,6 1.320
C6-391.02-32032	02535690	C6	C3	32,0 1.260	6,0 0.236	32,0 1.260	70,0 2.756	-	0	-	0,85 1.870
C6-391.02-40040	02459467	C6	C4	40,0 1.575	11,0 0.433	40,0 1.575	78,0 3.071	-	0	-	0,93 2.050
C6-391.02-50050A	03080019	C6	C5	50,0 1.969	20,0 0.787	50,0 1.969	88,0 3.465	-	0	-	1,1 2.430
C8-391.02-50045A	03080010	C8	C5	45,0 1.772	5,0 0.197	50,0 1.969	93,0 3.661	-	0	-	1,9 4.190
C8-391.02-63055A	03080012	C8	C6	55,0 2.165	15,0 0.591	63,0 2.480	103,0 4.055	-	0	-	2,1 4.630
C8-391.02R-63055A	03080030	C8	C6	55,0 2.165	15,0 0.591	63,0 2.480	103,0 4.055	*	0	-	1,9 4.190

Akcesoria

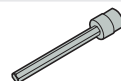

Dla

Klucz przedłużony

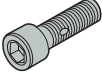

C5-391.02-32033A	5680015-05
C5-391.02-40040A	5680015-05
C6-391.02-32032	5680015-05
C6-391.02-40040	5680015-05
C6-391.02-50050A	5680015-01
C8-391.02-50045A	5680015-01
C8-391.02-63055A	5680015-02
C8-391.02R-63055A	5680015-02

Części zamienne, zawarte w dostawie

Dla	Śruba centralna	Pierścień zabezp.
		
C5-391.02-32033A	5512068-01	5545040-02
C5-391.02-40040A	5512068-06	5545040-07
C6-391.02-32032	5512068-01	5545040-02
C6-391.02-40040	5512068-02	5545040-03
C6-391.02-50050A	5512068-07	5545040-08
C8-391.02-50045A	5512068-08	5545040-08
C8-391.02-63055A	5512068-05	5545040-08
C8-391.02R-63055A	5512068-05	5545040-08

Akcesoria / Części zamienne

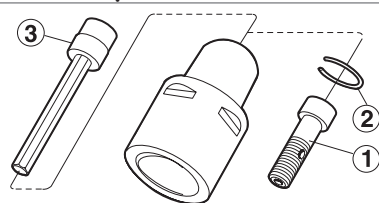

Akcesoria:
3 = Klucz przedłużony

Części zamienne:
1 = Śruba centralna
2 = Pierścień zabezpieczający

Wstęp

Wiercenie

Rozwiercanie

Wytaczanie

Załącznik

GL – Oprawki Steadyline® HSK-T/A -GL

średnica korpusu 25, 32, 40 i 50 mm / 0.984, 1.260, 1.575 i 1.969 cala

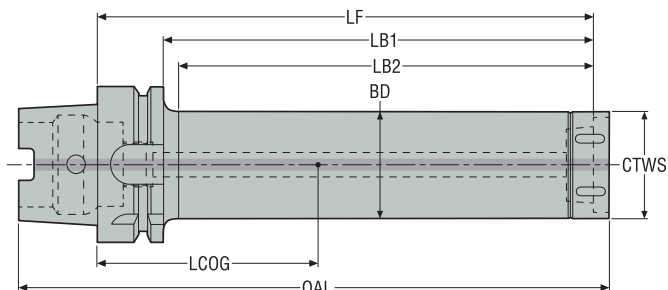

- Z tłumikiem drgań, gotowe do użycia
- Z doprowadzeniem chłodziwa
- * Maks. obr./min. tylko w przypadku gdy narzędzie jest obrotowe

Oznaczenie	Numer produktu	CTMS HSK-T/A	CTWS Wielkość GL	BD	LF	LB1	LB2	OAL	LCOG	Maks. obroty*	RFID otwór	Wyważenie	Waga
				mm cal.	mm cal.	mm cal.	mm cal.	mm cal.	mm cal.				kg lbs
HSKTA63-GL25-130-K	03214283	HSK-T/A63	GL25	25,0 0.984	130,0 5.118	104,0 4.094	101,0 3.976	166,5 6.555	37,0 1.457	0	1	PB	1,1 2.430
HSKTA63-GL25-180-K	03214284	HSK-T/A63	GL25	25,0 0.984	180,0 7.087	154,0 6.063	151,0 5.945	216,5 8.524	57,7 2.272	0	1	PB	1,3 2.870
HSKTA63-GL25-230-K	03214285	HSK-T/A63	GL25	25,0 0.984	230,0 9.055	204,0 8.031	201,0 7.913	266,5 10.492	80,3 3.161	0	1	PB	1,5 3.310
E9374-D32-160-GL32	03029521	HSK-T/A63	GL32	32,0 1.260	160,0 6.299	134,0 5.276	128,0 5.039	197,4 7.772	58,92 2.320	0	1	PB	1,6 3.530
E9374-D32-224-GL32	03029522	HSK-T/A63	GL32	32,0 1.260	224,0 8.819	198,0 7.795	192,0 7.559	261,4 10.291	90,22 3.552	0	1	PB	2,0 4.410
E9374-D40-208-GL40	03029523	HSK-T/A63	GL40	40,0 1.575	208,0 8.189	182,0 7.165	176,0 6.929	246,4 9.701	92,78 3.653	0	1	PB	2,7 5.950
E9374-D40-288-GL40	03029524	HSK-T/A63	GL40	40,0 1.575	288,0 11.339	262,0 10.315	256,0 10.079	326,4 12.850	134,37 5.290	0	1	PB	3,5 7.720
E9374-D50-268-GL50	03029525	HSK-T/A63	GL50	50,0 1.969	268,0 10.551	242,0 9.528	240,5 9.469	307,4 12.102	131,8 5.189	0	1	PB	4,8 10.580
E9374-D50-368-GL50	03029526	HSK-T/A63	GL50	50,0 1.969	368,0 14.488	342,0 13.465	340,5 13.406	407,4 16.039	184,79 7.275	0	1	PB	6,4 14.110
E9376-D32-160-GL32	03029527	HSK-T/A100	GL32	32,0 1.260	160,0 6.299	131,0 5.157	125,0 4.921	215,4 8.480	32,87 1.294	0	1	PB	3,0 6.610
E9376-D32-224-GL32	03029528	HSK-T/A100	GL32	32,0 1.260	224,0 8.819	195,0 7.677	189,0 7.441	279,4 11.000	54,97 2.164	0	1	PB	3,4 7.500
E9376-D32-288-GL32	03029529	HSK-T/A100	GL32	32,0 1.260	288,0 11.339	259,0 10.197	253,0 9.961	343,4 13.520	80,51 3.170	0	1	PB	3,8 8.380
E9376-D40-208-GL40	03029530	HSK-T/A100	GL40	40,0 1.575	208,0 8.189	179,0 7.047	173,0 6.811	264,4 10.409	62,83 2.474	0	1	PB	4,1 9.040
E9376-D40-288-GL40	03029531	HSK-T/A100	GL40	40,0 1.575	288,0 11.339	259,0 10.197	253,0 9.961	344,4 13.559	98,31 3.870	0	1	PB	4,9 10.800
E9376-D40-368-GL40	03029532	HSK-T/A100	GL40	40,0 1.575	368,0 14.488	339,0 13.346	333,0 13.110	424,4 16.709	139,77 5.503	0	1	PB	5,8 12.790
E9376-D50-268-GL50	03029533	HSK-T/A100	GL50	50,0 1.969	268,0 10.551	239,0 9.409	234,0 9.213	325,4 12.811	104,26 4.105	0	1	PB	6,2 13.670
E9376-D50-368-GL50	03029534	HSK-T/A100	GL50	50,0 1.969	368,0 14.488	339,0 13.346	334,0 13.150	425,4 16.748	154,26 6.073	0	1	PB	7,8 17.200
E9376-D50-468-GL50	03029535	HSK-T/A100	GL50	50,0 1.969	468,0 18.425	439,0 17.283	434,0 17.087	525,4 20.685	211,61 8.331	0	1	PB	9,7 21.380

Akcesoria

Dla wielkości	Wymienny moduł	Klucz dynamometryczny
GL25	-	-
GL32	SL00-32	SL00-32.250
GL40	SL00-40	SL00-40.350
GL50	SL00-50	SL00-50.550

Części zamienne, zawarte w dostawie

Dla wielkości	Klucz mocujący
GL25	SL25
GL32	SL32
GL40	SL40
GL50	SL50

Wstęp

Wiercenie

Rozwiercanie

Wytaczanie

Załącznik

BA – Oprawki Steadyline® HSK-T/A -BA, średnica korpusu 60 i 80 mm / 2.362 i 3.150 cala

średnica korpusu 60 i 80 mm / 2.362 i 3.150 cala

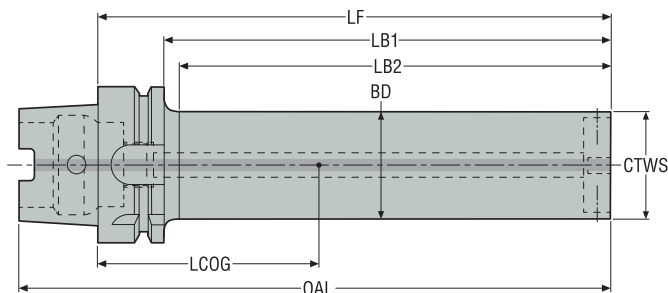

- Z tłumikiem drgań, gotowe do użycia
- Aby zamocować adaptery BA na GL z głowicami tokarskimi GL
- Z doprowadzeniem chłodziwa
- * Maks. obr./min. tylko w przypadku gdy narzędzie jest obrotowe

Oznaczenie	Numer produktu	CTMS Wielkość HSK-T/A	CTWS BA connection	BD	LF	LB1	LB2	OAL	LCOG	Maks. obroty*	RFID otwór	Wywa- żenie	Waga
				mm cal.	mm cal.	mm cal.	mm cal.	mm cal.	mm cal.				kg lbs
E9376-D60-301-BA060	03062828	HSK-T/A100	BA060	60,0 2.362	301,0 11.850	272,0 10.709	267,0 10.512	351,0 13.819	133,05 5.238	4000	1	PB	8,9 19.620
E9376-D60-421-BA060	03062829	HSK-T/A100	BA060	60,0 2.362	421,0 16.575	392,0 15.433	387,0 15.236	471,0 18.543	197,17 7.763	0	1	PB	11,8 26.010
E9376-D60-541-BA060	03062830	HSK-T/A100	BA060	60,0 2.362	541,0 21.299	512,0 20.157	507,0 19.961	591,0 23.268	260,56 10.258	0	1	PB	14,5 31.970
E9376-D80-421-BA080	03064109	HSK-T/A100	BA080	80,0 3.150	421,0 16.575	392,0 15.433	387,0 15.236	471,0 18.543	209,68 8.255	0	1	PB	19,4 42.770
E9376-D80-581-BA080	03064111	HSK-T/A100	BA080	80,0 3.150	581,0 22.874	552,0 21.732	547,0 21.535	631,0 24.843	295,45 11.632	0	1	PB	26,2 57.760

Akcesoria

Dla wiel-
kości

Klucz mocujący



BA060

03H04

BA080

03H05

Części zamienne, zawarte w dostawie

Dla wiel-
kości

Śruba mocująca



BA060

90FQ4

BA080

90FQ52

GL – Oprawki Steadyline® GL

średnica korpusu 25, 32, 40 i 50 mm / 0.984, 1.260, 1.575 i 1.969 cala

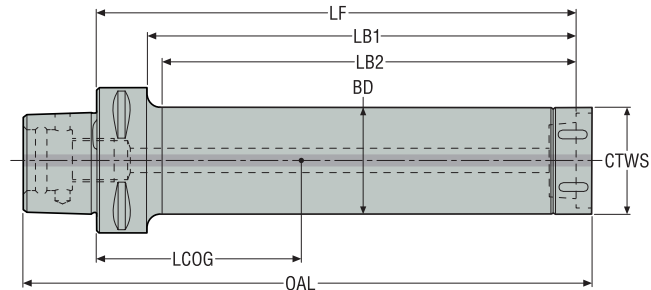

- Z tłumikiem drgań, gotowe do użycia
- Z doprowadzeniem chłodziwa
- * Maks. obr./min. tylko w przypadku gdy narzędzie jest obrotowe

Oznaczenie	Numer produktu	CTMS Wielkość Seco-Capto™	CTWS Wielkość GL	BD	LF	LB1	LB2	OAL	LCOG	Maks. obroty*	RFID otwór	Wywa- żenie	Waga
				mm cal.	mm cal.	mm cal.	mm cal.	mm cal.	mm cal.				
C4-D25-130-GL25	03214272	C4	GL25	25,0 0.984	130,0 5.118	110,0 4.331	107,0 4.213	158,5 6.240	51,8 2.039	0	0	PB	0,8 1.760
C4-D25-180-GL25	03214273	C4	GL25	25,0 0.984	180,0 7.087	160,0 6.299	157,0 6.181	208,5 8.209	77,2 3.039	0	0	PB	1,0 2.200
C4-D32-160-GL32	02807837	C4	GL32	32,0 1.260	160,0 6.299	140,0 5.512	137,0 5.394	189,4 7.457	74,73 2.942	0	0	PB	1,2 2.650
C4-D32-224-GL32	02807838	C4	GL32	32,0 1.260	224,0 8.819	204,0 8.031	201,0 7.913	253,4 9.976	109,16 4.298	0	0	PB	1,7 3.750
C5-D25-130-GL25	03214274	C5	GL25	25,0 0.984	130,0 5.118	110,0 4.331	107,0 4.213	164,5 6.476	41,8 1.646	0	1	PB	0,9 1.980
C5-D25-180-GL25	03214275	C5	GL25	25,0 0.984	180,0 7.087	160,0 6.299	157,0 6.181	214,5 8.445	65,1 2.563	0	1	PB	1,1 2.430
C5-D25-230-GL25	03214276	C5	GL25	25,0 0.984	230,0 9.055	210,0 8.268	207,0 8.150	264,5 10.413	89,8 3.535	0	1	PB	1,3 2.870
C5-D32-160-GL32	02807840	C5	GL32	32,0 1.260	160,0 6.299	140,0 5.512	136,0 5.354	195,4 7.693	65,15 2.565	0	1	PB	1,4 3.090
C5-D32-224-GL32	02807841	C5	GL32	32,0 1.260	224,0 8.819	204,0 8.031	200,0 7.874	259,4 10.213	98,47 3.877	0	1	PB	1,8 3.970
C5-D32-288-GL32	02807842	C5	GL32	32,0 1.260	288,0 11.339	268,0 10.551	264,0 10.394	323,4 12.732	133,61 5.260	0	1	PB	2,2 4.850
C5-D40-208-GL40	02807843	C5	GL40	40,0 1.575	208,0 8.189	188,0 7.402	184,0 7.244	244,4 9.622	98,32 3.871	0	1	PB	2,5 5.510
C5-D40-288-GL40	02807844	C5	GL40	40,0 1.575	288,0 11.339	268,0 10.551	264,0 10.394	324,4 12.772	140,88 5.546	0	1	PB	3,3 7.280
C6-D25-130-GL25	03214277	C6	GL25	25,0 0.984	130,0 5.118	105,0 4.134	102,0 4.016	172,5 6.791	30,4 1.197	0	1	PB	1,3 2.870
C6-D25-180-GL25	03214278	C6	GL25	25,0 0.984	180,0 7.087	155,0 6.102	152,0 5.984	222,5 8.760	49,3 1.941	0	1	PB	1,5 3.310
C6-D25-230-GL25	03214279	C6	GL25	25,0 0.984	230,0 9.055	205,0 8.071	202,0 7.953	272,5 10.728	70,2 2.764	0	1	PB	1,7 3.750
C6-D32-160-GL32	02807846	C6	GL32	32,0 1.260	160,0 6.299	135,0 5.315	129,0 5.079	203,4 8.008	52,06 2.050	0	1	PB	1,8 3.970
C6-D32-224-GL32	02807847	C6	GL32	32,0 1.260	224,0 8.819	199,0 7.835	193,0 7.598	267,4 10.528	82,17 3.235	0	1	PB	2,2 4.850
C6-D32-288-GL32	02807848	C6	GL32	32,0 1.260	288,0 11.339	263,0 10.354	257,0 10.118	331,4 13.047	114,87 4.522	0	1	PB	2,6 5.730
C6-D40-208-GL40	02807849	C6	GL40	40,0 1.575	208,0 8.189	183,0 7.205	177,0 6.969	252,4 9.937	86,42 3.402	0	1	PB	2,9 6.390

Wstęp

Wiercenie

Rozwiercanie

Wytaczanie

Załącznik

Oznaczenie	Numer produktu	CTMS Wielkość Seco-Capto™	CTWS Wielkość GL	BD	LF	LB1	LB2	OAL	LCOG	Maks. obroty*	RFID otwór	Wywa- żenie	Waga
				mm cal.	mm cal.	mm cal.	mm cal.	mm cal.	mm cal.				kg lbs
C6-D40-288-GL40	02807850	C6	GL40	40,0 1.575	288,0 11.339	263,0 10.354	257,0 10.118	332,4 13.087	127,5 5.020	0	1	PB	3,7 8.160
C6-D40-368-GL40	02807851	C6	GL40	40,0 1.575	368,0 14.488	343,0 13.504	337,0 13.268	412,4 16.236	173,14 6.817	0	1	PB	4,6 10.140
C6-D50-268-GL50	02807852	C6	GL50	50,0 1.969	268,0 10.551	243,0 9.567	238,0 9.370	313,4 12.339	126,6 4.984	0	1	PB	5,0 11.020
C6-D50-368-GL50	02807853	C6	GL50	50,0 1.969	368,0 14.488	343,0 13.504	338,0 13.307	413,4 16.276	179,44 7.065	0	1	PB	6,6 14.550
C6-D50-468-GL50	02807854	C6	GL50	50,0 1.969	468,0 18.425	443,0 17.441	438,0 17.244	513,4 20.213	238,49 9.389	0	1	PB	8,5 18.740
C8-D32-224-GL32	03029356	C8	GL32	32,0 1.260	224,0 8.819	191,0 7.520	181,0 7.126	277,5 10.925	58,17 2.290	0	1	PB	3,2 7.050
C8-D32-288-GL32	03029357	C8	GL32	32,0 1.260	288,0 11.339	255,0 10.039	245,0 9.646	341,5 13.445	84,7 3.335	0	1	PB	3,6 7.940
C8-D40-288-GL40	03029358	C8	GL40	40,0 1.575	288,0 11.339	255,0 10.039	245,0 9.646	341,5 13.445	102,14 4.021	0	1	PB	4,7 10.360
C8-D40-368-GL40	03029359	C8	GL40	40,0 1.575	368,0 14.488	335,0 13.189	325,0 12.795	422,5 16.634	144,04 5.671	0	1	PB	5,6 12.350
C8-D50-268-GL50	03029360	C8	GL50	50,0 1.969	268,0 10.551	235,0 9.252	225,0 8.858	323,4 12.732	107,59 4.236	0	1	PB	5,9 13.010
C8-D50-368-GL50	03029361	C8	GL50	50,0 1.969	368,0 14.488	335,0 13.189	325,0 12.795	423,4 16.669	158,08 6.224	0	1	PB	7,5 16.530
C8-D50-468-GL50	03029362	C8	GL50	50,0 1.969	468,0 18.425	435,0 17.126	425,0 16.732	523,4 20.606	215,6 8.488	0	1	PB	9,4 20.720

Akcesoria

Dla wiel- kości	Wymienny moduł	Klucz dynamo- metryczny
GL25	-	-
GL32	SL00-32	SL00-32.250
GL40	SL00-40	SL00-40.350
GL50	SL00-50	SL00-50.550

Części zamienne, zawarte w dostawie

Dla wiel- kości	Klucz mocujący
GL25	SL25
GL32	SL32
GL40	SL40
GL50	SL50

Wstęp

Wiercenie

Rozwiercanie

Wytaczanie

Załącznik

BA – Oprawki Steadyline® BA

średnica korpusu 60 i 80 mm / 2.362 i 3.150 cala

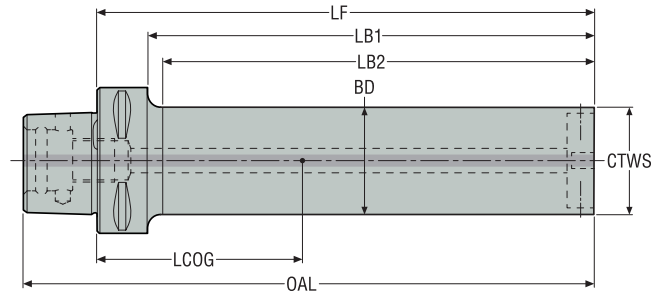

- Z tłumikiem drgań, gotowe do użycia
- Aby zamocować adaptory BA na GL z głowicami tokarskimi GL
- Z doprowadzeniem chłodziwa
- * Maks. obr./min. tylko w przypadku gdy narzędzie jest obrotowe

Oznaczenie	Numer produktu	CTMS Wielkość Seco-Capto™	CTWS Wielkość BA	BD	LF	LB1	LB2	OAL	LCOG	Maks. obroty*	RFID otwór	Wyważenie	Waga
				mm cal.	mm cal.	mm cal.	mm cal.	mm cal.	mm cal.				kg lbs
C6-D60-301-BA060	03062831	C6	BA060	60,0 2.362	301,0 11.850	276,0 10.866	273,0 10.748	339,0 13.346	151,74 5.974	4000	1	PB	7,8 17.200
C6-D60-421-BA060	03062832	C6	BA060	60,0 2.362	421,0 16.575	396,0 15.591	393,0 15.472	459,0 18.071	218,63 8.607	3000	1	PB	10,6 23.370
C8-D60-301-BA060	03062833	C8	BA060	60,0 2.362	301,0 11.850	268,0 10.551	263,0 10.354	349,0 13.740	137,04 5.395	4000	1	PB	8,6 18.960
C8-D60-421-BA060	03062834	C8	BA060	60,0 2.362	421,0 16.575	388,0 15.276	383,0 15.079	469,0 18.465	202,5 7.972	3000	1	PB	11,4 25.130
C8-D60-541-BA060	03062835	C8	BA060	60,0 2.362	541,0 21.299	508,0 20.000	503,0 19.803	589,0 23.189	266,78 10.503	2000	1	PB	14,0 30.860
C8-D80-421-BA080	03065829	C8	BA080	80,0 3.150	421,0 16.575	388,0 15.276	383,0 15.079	469,0 18.465	213,89 8.421	3000	1	PB	18,8 41.450
C8-D80-581-BA080	03065830	C8	BA080	80,0 3.150	581,0 22.874	548,0 21.575	543,0 21.378	629,0 24.764	300,38 11.826	2000	1	PB	25,1 55.340

Akcesoria

Dla wielkości	Klucz mocujący
BA060	03H04
BA080	03H05

Części zamienne, zawarte w dostawie

Dla wielkości	Śruba mocująca
BA060	90FQ4
BA080	90FQ52

Wstęp

Wiercenie

Rozwiercanie

Wytaczanie

Załącznik



Wytaczanie zgrubne

Oferta produktów firmy Seco do wytaczania zgrubnego maksymalizuje prędkość usuwania materiału i dokładność dzięki wysokiej wytrzymałości i sztywności konstrukcji. Zaprojektowane dla operacji symetrycznych i niesymetrycznych. Rozwiązania z zakresu tłumienia drgań Steadylite™ uzupełniają ofertę, zapewniając jeszcze większą stabilność podczas obróbki zagłębień, gdzie wymagane są długie wysięgi.

- Głowice do obróbki zgrubnej RB 750 zapewniają najwyższą możliwą wydajność wytaczania wstępnego
- Głowice do obróbki zgrubnej RB 610 to krótkie, proste, solidne głowice do wytaczania wstępnego

Głowice do zgrubnego wytaczania

Wstęp

Wiercenie

Rozwiercanie

Wytaczanie

Zalącznik

Graflex®



Ø 18-24 (Ø 0.709"-0.945")



Ø 23-31 (Ø 0.906"-1.220")



Ø 30-40 (Ø 1.181"-1.575")



Ø 39-51 (Ø 1.535"-2.008")



Ø 50-65 (Ø 1.968"-2.559")



Ø 64-86 (Ø 2.520"-3.386")



Ø 85-144 (Ø 3.346"-5.669")



Ø 114-205 (Ø 4.488"-8.071")

Seco-Capto™



Ø 39-51 (Ø 1.535"-2.008")



Ø 50-65 (Ø 1.968"-2.559")



Ø 64-86 (Ø 2.520"-3.386")



Ø 85-144 (Ø 3.346"-5.669")



Ø 114-205 (Ø 4.488"-8.071")

Wytaczanie symetryczne:
2 standardowe wkładki typu A

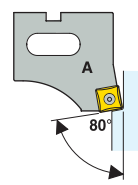
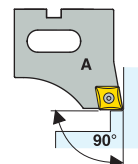
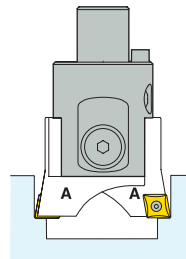

Wytaczanie niesymetryczne:
1 wkładka przedłużona typu B i 1 wkładka standardowa typu A

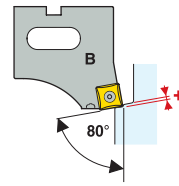
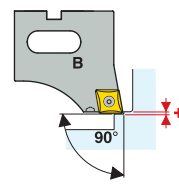
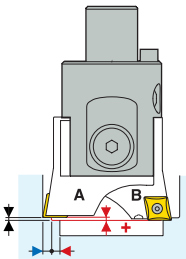

Właściwości

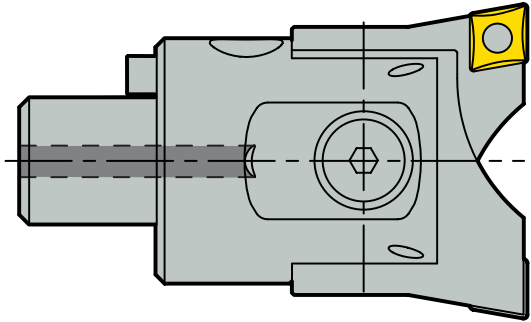
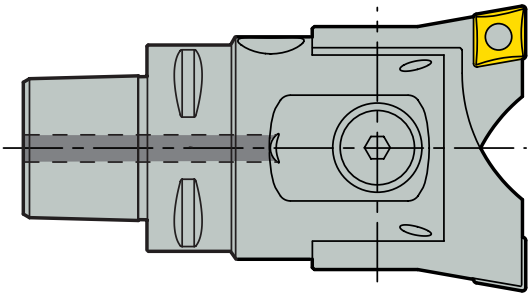
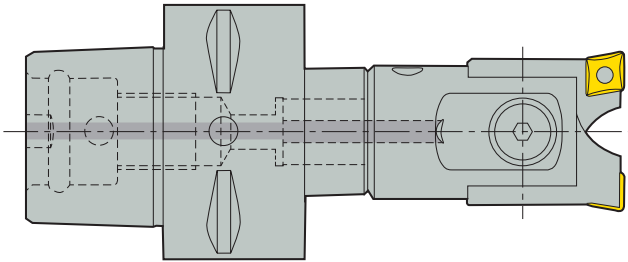
<p>Głowice do obróbki zgrubnej Graflex®</p> <ul style="list-style-type: none"> • \varnothing 18 do 205 mm (0.709–8.071") • 8 głowic do wytaczania wstępnego RB 750 z połączeniem Graflex® do otworów \varnothing 18 do 205 mm (0.709–8.071") 		Wstęp
<p>Głowice Seco-Capto™ do obróbki zgrubnej</p> <ul style="list-style-type: none"> • Uwaga: Minimalna średnica otworu dla głowicy na gotowo Seco-Capto™ wynosi \varnothing 39 mm (1.535") z najmniejszym dostępnym mocowaniem Seco-Capto™ C3. • W zakresie \varnothing 18-40 mm (0.709-1.575") należy stosować głowice Graflex® z połączeniem o wielkości G0 do G2 razem z adapterem Seco-Capto™/Graflex®. 		Wiercenie
<p>Głowice Seco-Capto™ do obróbki zgrubnej</p> <ul style="list-style-type: none"> • Uwaga: Opisy, instrukcje (mocowanie wkładek, nastawianie średnicy, wytaczanie wsteczne, rozwiązywanie problemów, zalecane warunki obróbki, maksymalne prędkości), odpowiednie wkładki oraz płytki są podobne dla obu typów głowic na gotowo RB 750 w odpowiednich zakresach, bez względu na typ połączenia. • Modułowe zespoły i warunki skrawania z wykorzystaniem adapterów Seco-Capto™ i Graflex® oraz rozszerzenia modułowe: patrz katalog opravek narzędziowych. 		Rozwiercanie
		Wytaczanie
		Załącznik

Właściwości

Konstrukcja głowicy składa się z korpusu oraz 2 wkładek

Możliwa jest równoczesna lub niezależna regulacja wkładek:

Równoczesna regulacja za pomocą mechanizmu sprzęgającego (brak mechanizmu sprzęgającego w najmniejszej głowicy \varnothing 18 do 24 mm) (0.709-0.9445").

Obie śruby regulacyjne poruszają 2 wkładki równocześnie (połączone sprzęgłem).

Możliwe jest ustawienie średnicy bez narzędzia do wstępnego ustawiania (1 skok = 0,1 mm (0.004") średnicy).

Możliwa jest również regulacja niezależna: odłączyć mechanizm sprzęgający, aby każda śruba regulacyjna działała jedynie na przypisaną jej wkładkę.

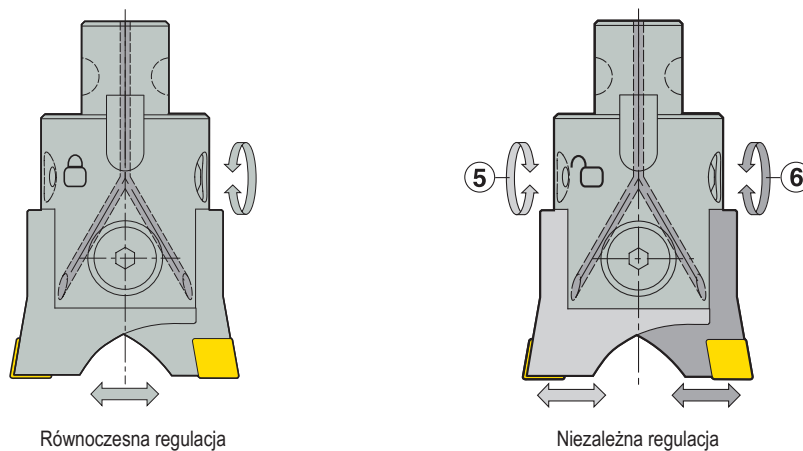

Równoczesna regulacja

Niezależna regulacja

Wytaczanie symetryczne:

Wytaczanie symetryczne oznacza, że obie krawędzie skrawające ustawione są na tę samą średnicę. Wymaga to dwóch identycznych standardowych wkładek typu A (z identycznym kątem przystawienia).

Wytaczanie niesymetryczne:

Wytaczanie niesymetryczne oznacza, że jedna krawędź skrawająca jest wysunięta jako główna krawędź, pracująca na mniejszej średnicy niż druga, ustawiona na średnicę gotowego otworu. Wymaga to jednej standardowej wkładki typu A oraz jednej przedłużonej wkładki typu B, co umożliwi osiągnięcieżądanego przesunięcia osiowego (+).

Wkładki na płytce o kącie przystawienia 90° lub 80°

Wkładki na płytce A75...CC... i A75...CP... charakteryzują się kątem przystawienia 90° dla płytek rombówych: najbardziej odpowiednie do otworów nieprzelotowych oraz wymagających mniejszego momentu obrotowego wrzeciona.

Wkładki na płytce A75...CC... i A75...CP... mają kąt przystawienia 80° dla płytek rombówych: najbardziej odpowiednie dla otworów przelotowych i do trudnej obróbki. Ustawienie kątowe krawędzi skrawających jest zgodne z ISO.

Właściwości

Wkładki na płytce typu CC, CP, SC lub CN

Wkładki na płytce A750...CC..., A750...CP... i A750...SC... charakteryzują się kątem natarcia 0° (GAMO) i kątem nachylenia 0° (LAMS).

Wkładki na płytce wymienne A750...CN mają kąt przystawienia -6° (GAMO) i -6° kąt ustawienia płytki (LAMS), umożliwiając stosowanie płytek o ujemnym kącie natarcia CNMM oraz wieloostrowych płytek CNMG z 4 ostrzami skrawającymi.

W tym przypadku, ważne jest zastosowanie płytek CN oraz rekomendowanych parametrów skrawania (patrz strony 654).

Stosowanie innych płytek lub parametrów może doprowadzić do uszkodzenia obrabiarki lub detalu.

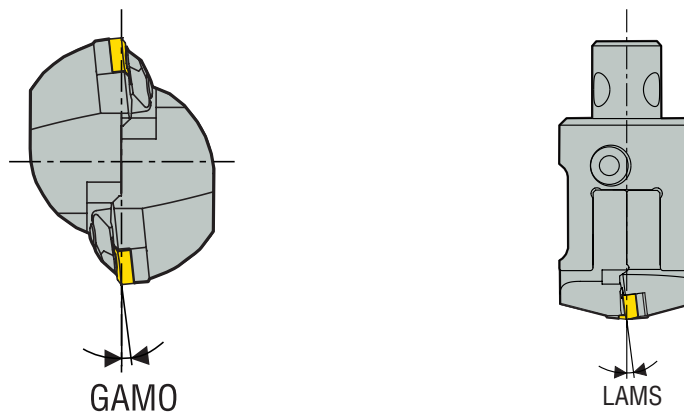

RB750

Graflex®

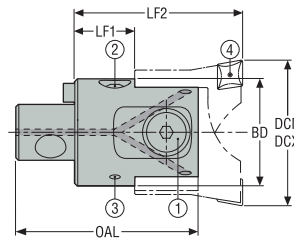

- Możliwe jest wytaczanie symetryczne i stopniowe
- Jednoczesna regulacja za pomocą mechanizmu sprzęgającego wkładek płytek

1. Śruba montażowa
2. Śruba regulacyjna
3. Śruba blokująca mechanizmu sprzęgającego
4. Śruba mocująca płytkę

Oznaczenie	Numer produktu	Wielk. Graflex	Od strony detalu Zakres DCN-DCX Ø		OAL	LF1	LF2	BD	Waga	Tryb regulacji synchronicznej		Tryb regulacji niezależnej		Maks. obr./min.
			mm Cal.	mm Cal.						Tak	Nie	Tak	Nie	
A75000	00026687	G0	18,0 0.709	24,0 0.945	38,0 1.496	12,5 0.492	35,0 1.378	16,5 0.650	0,03 0.070		■	■		15000
A75010	00026688	G1	23,0 0.906	31,0 1.220	42,5 1.673	13,5 0.531	40,0 1.575	21,5 0.846	0,1 0.220	■		■		12000
A75020	00026689	G2	30,0 1.181	40,0 1.575	51,0 2.008	16,0 0.630	46,0 1.811	27,0 1.063	0,11 0.240	■		■		9500
A75030	00026690	G3	39,0 1.535	51,0 2.008	69,0 2.717	24,0 0.945	65,0 2.559	35,0 1.378	0,5 1.100	■		■		7500
A75040	00026691	G4	50,0 1.969	65,0 2.559	78,0 3.071	27,0 1.063	72,0 2.835	43,0 1.693	0,46 1.010	■		■		5700
A75050	00026692	G5	64,0 2.520	86,0 3.386	92,0 3.622	30,0 1.181	82,0 3.228	54,0 2.126	0,8 1.760	■		■		4500
A75060	00026693	G6	85,0 3.346	144,0 5.669	119,0 4.685	37,0 1.457	105,0 4.134	70,0 2.756	1,69 3.730	■		■		3500
A75070	00026694	G7	114,0 4.488	205,0 8.071	143,0 5.630	39,0 1.535	120,0 4.724	95,0 3.740	3,7 8.160	■		■		2500

Wkładki należy zamawiać oddzielnie, patrz strona(y) 569-573

Uwaga: Waga podana bez wkładki

Części zamienne, zawarte w dostawie

Do głowicy	Śruba mocująca	Zabierak
A75000	90A75000	90M0
A75010	90A75010	90M11
A75020	90A75020	90M21
A75030	90A75030	90M31
A75040	90A75040	90M41
A75050	90A75050	90M51
A75060	90A75060	90M61
A75070	90A75070	90M71

Wstęp

Wiercenie

Rozwiercanie

Wytaczanie

Załącznik

Akcesoria

Do głowicy	Klucz mocujący	Klucz do zabieraka	Klucz do płytki	Klucz (Typu T)	Klucz ustawczy
A75000	03HL03	-	H4B-T07P	DOUBLE-T	H1.5-2D
A75010	03HL03	H4B-T06P	H4B-T07P	DOUBLE-T	H1.5-2D
A75020	03HL04	H4B-T07P	-	DOUBLE-T	H2.0-2D
A75030	03HL05	H4B-T08P	-	DOUBLE-T	H2.0-2D
A75040	03HL05	H4B-T09P	-	DOUBLE-T	H2.5-2D
A75050	03HL06	-	-	DOUBLE-T	03M03C
A75060	03HL08	-	-	DOUBLE-T	-
A75070	03HL10	H4B-T15P	H4B-T15PL	DOUBLE-T	-

Akcesoria, należy zamawiać osobno

RB750

Seco-Capto™

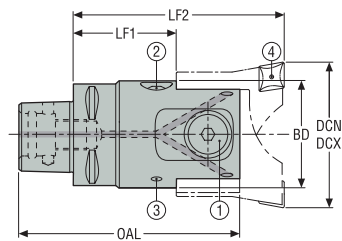

- Możliwe jest wytaczanie symetryczne i stopniowe
- Jednoczesna regulacja za pomocą mechanizmu sprzęgającego wkładek płytek

1. Śruba montażowa
2. Śruba regulacyjna
3. Śruba blokująca mechanizmu sprzęgającego
4. Śruba mocująca płytkę

Oznaczenie	Numer produktu	Wielkość Capto	Od strony detalu Zakres DCN-DCX Ø		OAL	LF1	LF2	BD	Waga	Tryb regulacji synchronicznej		Tryb regulacji niezależnej		Maks. obr/min.
			mm Cal.	mm Cal.						Tak	Nie	Tak	Nie	
C3-391.0750-30	02809726	C3	39,0 1.535	51,0 2.008	73,0 2.874	29,0 1.142	70,0 2.756	35,0 1.378	0,28 0.620	■	■	■	■	7500
C4-391.0750-40	02809728	C4	50,0 1.969	65,0 2.559	88,0 3.465	37,0 1.457	82,0 3.228	43,0 1.693	0,52 1.150	■	■	■	■	5700
C5-391.0750-50	02809733	C5	64,0 2.520	86,0 3.386	102,0 4.016	40,0 1.575	92,0 3.622	54,0 2.126	0,94 2.070	■	■	■	■	4500
C6-391.0750-60	02809735	C6	85,0 3.346	144,0 5.669	129,0 5.079	49,0 1.929	117,0 4.606	70,0 2.756	1,88 4.140	■	■	■	■	3500
C8-391.0750-70	02809736	C8	114,0 4.488	205,0 8.071	159,0 6.260	57,0 2.244	138,0 5.433	95,0 3.740	4,14 9.130	■	■	■	■	2500

Wkładki należy zamawiać oddzielnie, patrz strona(y) 569-573
Uwaga: Waga podana bez wkładki

Części zamienne, zawarte w dostawie

Do głowicy	Śruba mocująca
C3-...-30	90A75030
C4-...-40	90A75040
C5-...-50	90A75050
C6-...-60	90A75060
C8-...-70	90A75070

Akcesoria

Do głowicy	Klucz mocujący	Klucz do zabieraka	Klucz (Typu T)	Klucz ustawczy
C3-...-30	03HL05	H4B-T08P	DOUBLE-T	H2.0-2D
C4-...-40	03HL05	H4B-T09P	DOUBLE-T	H2.5-2D
C5-...-50	03HL06	-	DOUBLE-T	03M03C
C6-...-60	03HL08	-	DOUBLE-T	∅
C8-...-70	03HL10	-	DOUBLE-T	∅

Akcesoria, należy zamawiać osobno

Wkładki płytek 90° dla płytek CC.. I CP..

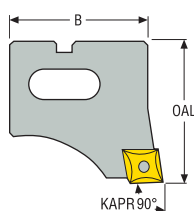

- Do montażu na głowicach RB 750
- Wytaczanie symetryczne wymaga dwóch standardowych wkładek typu A
- Wytaczanie stopniowe wymaga jednej standardowej wkładki typu A i jednej wkładki typu B

Oznaczenie	Numer produktu	Typ wkładki	Do głowicy	Zakres DCN-DCX Ø		OAL	B	Waga	KRINS°	Odpowiednia wielkość płytki
				mm Cal.	mm Cal.					
A7500CP0590	00026695	Standardowy typu A	RB 75000	18,0 0.709	24,0 0.945	22,5 0.886	16,5 0.650	0,01 0.020	90	CP...0502...
A75010CC0690	00026696	Standardowy typu A	RB 75010	23,0 0.906	31,0 1.220	26,5 1.043	21,5 0.846	0,1 0.220	90	CC...0602...
A75020CC0690	00026697	Standardowy typu A	RB 75020	30,0 1.181	40,0 1.575	30,0 1.181	27,0 1.063	0,04 0.090	90	CC...0602...
A75030CC0990	00026698	Standardowy typu A	RB 75030	39,0 1.535	51,0 2.008	41,0 1.614	35,0 1.378	0,1 0.220	90	CC...09T3...
A75040CC1290	00026699	Standardowy typu A	RB 75040	50,0 1.969	65,0 2.559	45,0 1.772	43,0 1.693	0,14 0.310	90	CC...1204...
A75050CC1290	00026700	Standardowy typu A	RB 75050	64,0 2.520	86,0 3.386	52,0 2.047	54,0 2.126	0,3 0.660	90	CC...1204...
A75060CC1290	00026701	Standardowy typu A	RB 75060	85,0 3.346	115,0 4.528	68,0 2.677	70,0 2.756	0,55 1.210	90	CC...1204...
A75060CC1690	00030763	Standardowy typu A	RB 75060	85,0 3.346	115,0 4.528	68,0 2.677	70,0 2.756	0,55 1.210	90	CC...1605...
A75065CC1290	00026702	Standardowy typu A	RB 75060	114,0 4.488	144,0 5.669	68,0 2.677	100,0 3.937	0,89 1.960	90	CC...1204...
A75065CC1690	00030765	Standardowy typu A	RB 75060	114,0 4.488	144,0 5.669	68,0 2.677	100,0 3.937	0,9 1.980	90	CC...1605...
A75070CC1290	00026703	Standardowy typu A	RB 75070	114,0 4.488	160,0 6.299	81,0 3.189	95,0 3.740	1,18 2.600	90	CC...1204...
A75070CC1690	00030766	Standardowy typu A	RB 75070	114,0 4.488	160,0 6.299	81,0 3.189	95,0 3.740	1,18 2.600	90	CC...1605...
A75075CC1290	00026704	Standardowy typu A	RB 75070	159,0 6.260	205,0 8.071	81,0 3.189	141,0 5.551	2,0 4.410	90	CC...1204...
A75075CC1690	00030771	Standardowy typu A	RB 75070	159,0 6.260	205,0 8.071	81,0 3.189	141,0 5.551	2,0 4.410	90	CC...1605...

Części zamienne, zawarte w dostawie

Dla płytki o wielkości	Klucz do płytki	Klucz (Typu T)	Śruba
CP...0502...	H4B-T07P	DOUBLE-T	C02245-T07P
CC...0602...	H4B-T07P	DOUBLE-T	C02504-T07P
CC...09T3...	H4B-T15P	DOUBLE-T	C04008-T15P
CC...1204...	H4B-T15P	DOUBLE-T	C05012-T15P
CC...1605...	H4B-T15P	DOUBLE-T	C05012-T15P

Zalecane płytki do wytaczania zgrubnego - patrz str. 654

Wkładki płytek 90° dla płytek CC.. I CP..

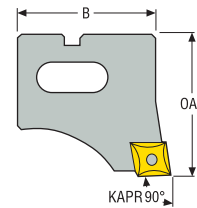

- Do montażu na głowicach RB 750
- Wytaczanie symetryczne wymaga dwóch standardowych wkładek typu A
- Wytaczanie stopniowe wymaga jednej standardowej wkładki typu A i jednej wkładki typu B

Oznaczenie	Numer produktu	Typ wkładki	Do głowicy	Zakres DCN-DCX Ø		OAL	B	Waga	KRINS°	Odpowiednia wielkość płytki
				mm Cal.	mm Cal.	mm Cal.	mm Cal.			
A75001CP0590	00026705	Przedłużony typu B	RB 75000	18,0 0.709	24,0 0.945	22,8 0.898	16,5 0.650	0,01 0.020	90	CP...0502...
A75011CC0690	00026706	Przedłużony typu B	RB 75010	23,0 0.906	31,0 1.220	26,85 1.057	21,5 0.846	0,02 0.040	90	CC...0602...
A75021CC0690	00026707	Przedłużony typu B	RB 75020	30,0 1.181	40,0 1.575	30,35 1.195	27,0 1.063	0,1 0.220	90	CC...0602...
A75031CC0990	00026708	Przedłużony typu B	RB 75030	39,0 1.535	51,0 2.008	41,4 1.630	35,0 1.378	0,08 0.180	90	CC...09T3...
A75041CC1290	00026709	Przedłużony typu B	RB 75040	50,0 1.969	65,0 2.559	46,5 1.831	43,0 1.693	0,13 0.290	90	CC...1204...
A75051CC1290	00026710	Przedłużony typu B	RB 75050	64,0 2.520	86,0 3.386	52,6 2.071	54,0 2.126	0,25 0.550	90	CC...1204...
A75061CC1290	00026711	Przedłużony typu B	RB 75060	85,0 3.346	115,0 4.528	68,6 2.701	70,0 2.756	0,55 1.210	90	CC...1204...
A75061CC1690	00030774	Przedłużony typu B	RB 75060	85,0 3.346	115,0 4.528	68,6 2.701	70,0 2.756	0,55 1.210	90	CC...1605...
A75066CC1290	00026712	Przedłużony typu B	RB 75060	114,0 4.488	144,0 5.669	68,6 2.701	100,0 3.937	0,91 2.010	90	CC...1204...
A75066CC1690	00030775	Przedłużony typu B	RB 75060	114,0 4.488	144,0 5.669	68,6 2.701	100,0 3.937	0,91 2.010	90	CC...1605...
A75071CC1290	00026713	Przedłużony typu B	RB 75070	114,0 4.488	160,0 6.299	81,6 3.213	95,0 3.740	1,16 2.560	90	CC...1204...
A75071CC1690	00030776	Przedłużony typu B	RB 75070	114,0 4.488	160,0 6.299	81,6 3.213	95,0 3.740	1,16 2.560	90	CC...1605...
A75076CC1290	00026714	Przedłużony typu B	RB 75070	159,0 6.260	205,0 8.071	81,6 3.213	141,0 5.551	2,0 4.410	90	CC...1204...
A75076CC1690	00030778	Przedłużony typu B	RB 75070	159,0 6.260	205,0 8.071	81,6 3.213	141,0 5.551	2,0 4.410	90	CC...1605...

Części zamienne, zawarte w dostawie

Dla płytki o wielkości	Klucz (Typu T)	Klucz	Śruba
CP...0502...	DOUBLE-T	H4B-T07P	C02245-T07P
CC...0602...	DOUBLE-T	H4B-T07P	C02504-T07P
CC...09T3...	DOUBLE-T	H6B-T15P	C04008-T15P
CC...1204...	DOUBLE-T	H6B-T15P	C05012-T15P
CC...1605...	DOUBLE-T	H6B-T15P	C05012-T15P

Zalecane płytki do wytaczania zgrubnego - patrz str. 654

Wstęp

Wfoczenie

Rozwiercanie

Wytaczanie

Załącznik

Wkładki płytek 80° dla płytek SC..

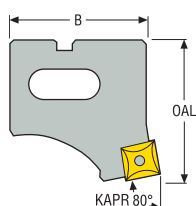



- Do montażu na głowicach RB 750
- Wytaczanie symetryczne wymaga dwóch standardowych wkładek typu A
- Wytaczanie stopniowe wymaga jednej standardowej wkładki typu A i jednej wkładki typu B

Oznaczenie	Numer produktu	Typ wkładki	Do głowicy	Zakres DCN-DCX Ø		OAL	B	Waga	KRINS°	Odpowiednia wielkość płytki
				mm Cal.	mm Cal.					
A7500SC0580	00026715	Standardowy typu A	RB 75000	18,0 0.709	24,0 0.945	22,5 0.886	16,5 0.650	0,01 0.020	80	SC...0502...
A75010SC0680	00026716	Standardowy typu A	RB 75010	23,0 0.906	31,0 1.220	26,5 1.043	21,5 0.846	0,02 0.040	80	SC...0602...
A75020SC0680	00026717	Standardowy typu A	RB 75020	30,0 1.181	40,0 1.575	30,0 1.181	27,0 1.063	0,1 0.220	80	SC...0602...
A75030SC0980	00026718	Standardowy typu A	RB 75030	39,0 1.535	51,0 2.008	41,0 1.614	35,0 1.378	0,08 0.180	80	SC...09T3...
A75040SC1280	00026719	Standardowy typu A	RB 75040	50,0 1.969	65,0 2.559	45,0 1.772	43,0 1.693	0,03 0.070	80	SC...1204...
A75050SC1280	00051986	Standardowy typu A	RB 75050	64,0 2.520	86,0 3.386	52,0 2.047	54,0 2.126	0,25 0.550	80	SC...1204...
A75060SC1280	00052207	Standardowy typu A	RB 75060	85,0 3.346	115,0 4.528	68,0 2.677	70,0 2.756	0,56 1.230	80	SC...1204...
A75060SC1580	00039863	Standardowy typu A	RB 75060	85,0 3.346	115,0 4.528	68,0 2.677	70,0 2.756	0,56 1.230	80	SC...1505...
A75065SC1280	00051989	Standardowy typu A	RB 75060	114,0 4.488	144,0 5.669	68,0 2.677	100,0 3.937	0,94 2.070	80	SC...1204...
A75065SC1580	00039865	Standardowy typu A	RB 75060	114,0 4.488	144,0 5.669	68,0 2.677	100,0 3.937	1,0 2.200	80	SC...1505...
A75070SC1280	00026723	Standardowy typu A	RB 75070	114,0 4.488	160,0 6.299	81,4 3.205	95,0 3.740	1,2 2.650	80	SC...1204...
A75070SC1580	00039867	Standardowy typu A	RB 75070	114,0 4.488	160,0 6.299	81,4 3.205	95,0 3.740	1,18 2.600	80	SC...1505...
A75075SC1280	00026724	Standardowy typu A	RB 75070	159,0 6.260	205,0 8.071	81,4 3.205	141,0 5.551	2,09 4.610	80	SC...1204...
A75075SC1580	00039869	Standardowy typu A	RB 75070	159,0 6.260	205,0 8.071	81,4 3.205	141,0 5.551	2,1 4.630	80	SC...1505...
A75001SC0580	00092946	Przedłużony typu B	RB 75000	18,0 0.709	24,0 0.945	23,2 0.913	16,5 0.650	0,01 0.020	80	SC...0502...
A75011SC0680	00092947	Przedłużony typu B	RB 75010	23,0 0.906	31,0 1.220	27,3 1.075	21,5 0.846	0,02 0.040	80	SC...0602...
A75021SC0680	00092948	Przedłużony typu B	RB 75020	30,0 1.181	40,0 1.575	30,9 1.217	27,0 1.063	0,04 0.090	80	SC...0602...
A75031SC0980	00092949	Przedłużony typu B	RB 75030	39,0 1.535	51,0 2.008	42,2 1.661	35,0 1.378	0,08 0.180	80	SC...09T3...
A75041SC1280	00092961	Przedłużony typu B	RB 75040	50,0 1.969	65,0 2.559	46,4 1.827	43,0 1.693	0,14 0.310	80	SC...1204...
A75051SC1280	00092962	Przedłużony typu B	RB 75050	64,0 2.520	86,0 3.386	53,7 2.114	54,0 2.126	0,26 0.570	80	SC...1204...
A75061SC1580	00039864	Przedłużony typu B	RB 75060	85,0 3.346	115,0 4.528	70,3 2.768	70,0 2.756	0,57 1.260	80	SC...1505...
A75061SC1280	00092963	Przedłużony typu B	RB 75060	85,0 3.346	115,0 4.528	69,8 2.748	70,0 2.756	0,57 1.260	80	SC...1204...

Oznaczenie	Numer produktu	Typ wkładki	Do głowicy	Zakres DCN-DCX \varnothing		OAL	B	Waga	KRINS°	Odpowiednia wielkość płytki
				mm Cal.	mm Cal.	mm Cal.	mm Cal.	kg lbs		
A75066SC1280	00092964	Przedłużony typu B	RB 75060	114,0 4.488	144,0 5.669	69,8 2.748	100,0 3.937	0,96 2.120	80	SC...1204...
A75066SC1580	00039866	Przedłużony typu B	RB 75060	114,0 4.488	144,0 5.669	70,3 2.768	100,0 3.937	0,96 2.120	80	SC...1505...
A75071SC1280	00092965	Przedłużony typu B	RB 75070	114,0 4.488	160,0 6.299	82,8 3.260	95,0 3.740	1,21 2.670	80	SC...1204...
A75071SC1580	00039868	Przedłużony typu B	RB 75070	114,0 4.488	160,0 6.299	83,3 3.280	95,0 3.740	1,21 2.670	80	SC...1505...
A75076SC1280	00092968	Przedłużony typu B	RB 75070	159,0 6.260	205,0 8.071	82,8 3.260	141,0 5.551	2,16 4.760	80	SC...1204...
A75076SC1580	00039870	Przedłużony typu B	RB 75070	159,0 6.260	205,0 8.071	83,3 3.280	141,0 5.551	2,14 4.720	80	SC...1505...

Części zamienne, zawarte w dostawie

Dla płytki o wielkości	Klucz (Typu T)	Klucz	Śruba
			
SC...0502...	DOUBLE-T	H4B-T07P	C02245-T07P
SC...0602...	DOUBLE-T	H4B-T07P	C02504-T07P
SC...09T3...	DOUBLE-T	-	C04008-T15P
SC...1204...	DOUBLE-T	H6B-T15P	C05012-T15P
SC...1505...	DOUBLE-T	H6B-T15P	C05012-T15P
SC...09T3...	DOUBLE-T	H6B-T15P	C04008-T15P
SC...1204...	DOUBLE-T	H6B-T15PL	C05012-T15P

Zalecane płytki do wytaczania zgrubnego - patrz str. 654

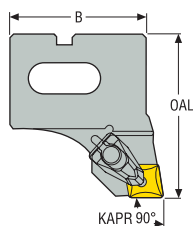

Wkładki płytek 90° dla płytek CN..



- Do montażu na głowicach RB 750
- Wytaczanie symetryczne wymaga dwóch standardowych wkładek typu A (przedłużone wkładki typu B do płytek CN.. są niedostępne)
- GAMO = Kąt natarcia = - 6°
- LAMS = Kąt zaklinowania = - 6°

Oznaczenie	Numer produktu	Typ wkładki	Do głowicy	Zakres DCN-DCX Ø		OAL	B	Waga	KRINS°	Odpowiednia wielkość płytki
				mm Cal.	mm Cal.					
A75050CN1290	02786307	Standardowy typu A	RB 75050	64,0 2.520	86,0 3.386	63,0 2.480	55,0 2.165	0,28 0.620	90	CN...1204...
A75060CN1290	02786308	Standardowy typu A	RB 75060	85,0 3.346	115,0 4.528	68,0 2.677	69,5 2.736	0,58 1.280	90	CN...1204...
A75065CN1290	02786309	Standardowy typu A	RB 75060	114,0 4.488	144,0 5.669	68,0 2.677	99,5 3.917	0,98 2.160	90	CN...1204...
A75070CN1290	02786310	Standardowy typu A	RB 75070	114,0 4.488	160,0 6.299	85,0 3.346	95,0 3.740	1,25 2.760	90	CN...1204...
A75075CN1290	02786311	Standardowy typu A	RB 75070	159,0 6.260	205,0 8.071	85,0 3.346	140,0 5.512	2,03 4.480	90	CN...1204...

Części zamienne, zawarte w dostawie

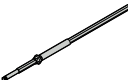
Dla płytki o wielkości	Śruba podkładki	Zestaw mocujący	Podkładka	Klucz
CN...1204...	 CSC6312-T15P	 CD12-S12	 UCN120612	 H6B-T15P

Zalecane płytki do wytaczania grubego - patrz str. 654

Instrukcje Zalecane warunki obróbki

Moc wrzeczona:

Ponieważ zgrubne wytaczanie wymaga dużej mocy obrabiarki, zalecamy sprawdzenie, czy obrabiarka dysponuje odpowiednią mocą. Niesymetryczne wytaczanie to rozwiązanie pozwalające ograniczyć zapotrzebowanie na moc, gdyż posuw jest podzielony na dwa przy takiej samej łącznej głębokości skrawania, w porównaniu do ustawienia symetrycznego.

Najlepsze wyniki uzyskuje się przy doprowadzeniu chłodziwa na ostrze (wyższe parametry, lepsze wykańczanie powierzchni, lepsze usuwanie wiórów, większa trwałość ostrza).

Szczegółowe instrukcje, patrz informacje dostarczane razem z głowicami wytaczarskimi oraz oprawkami Steadylite®.

Instrukcje można także pobrać ze strony www.secotools.com.

Prędkości maksymalne dla głowic do wytaczania zgrubnego

Wielkość głowicy	Zakres \varnothing mm	Zakres \varnothing cale	Maks. obr./min.	Domniemana maks. prędkość skrawania V_c przy min. zakresie m/min (sf/min)	Domniemana maks. prędkość skrawania V_c przy maks. zakresie m/min (sf/min)
Głowice do wytaczania wstępnego (z dwoma symetrycznie ustawionymi ostrzami) z połączeniem Graflex®					
A75000	18-24	0.709-0.945	15000	848 (2782)	1131 (3711)
A75010	23-31	0.906-1.220	12000	867 (2844)	1169 (3835)
A75020	30-40	1.181-1.575	9500	895 (2936)	1194 (3917)
A75030	39-51	1.535-2.008	7500	919 (3015)	1202 (3944)
A75040	50-65	1.969-2.559	5700	895 (2936)	1164 (3819)
A75050	64-86	2.520-3.386	4500	905 (2969)	1216 (3990)
A75060	85-115	3.346-4.528	3500	935 (3068)	1264 (4147)
A75060	114-144	4.488-5.669	2700	967 (3173)	1221 (4006)
A75070	114-160	4.488-6.299	2500	895 (2936)	1257 (4124)
A75070	159-205	6.260-8.071	2000	999 (3278)	1288 (4226)
Głowice do wytaczania wstępnego (z dwoma symetrycznie ustawionymi ostrzami) z połączeniem Seco-Capto™					
C3-391.0750-30	39-51	1.535-2.008	7500	919 (3015)	1202 (3944)
C4-391.0750-40	50-65	1.969-2.559	5700	895 (2936)	1164 (3819)
C5-391.0750-50	64-86	2.520-3.386	4500	905 (2969)	1216 (3990)
C6-391.0750-60	85-115	3.346-4.528	3500	935 (3068)	1264 (4147)
C6-391.0750-60	114-144	4.488-5.669	2700	967 (3173)	1221 (4006)
C8-391.0750-70	114-160	4.488-6.299	2500	895 (2936)	1257 (4124)
C8-391.0750-70	159-205	6.260-8.071	2000	999 (3278)	1288 (4226)

Uwaga: Maksymalne prędkości są uzależnione od mechanicznej konstrukcji głowicy oraz jakości wyważenia. Prędkość z podanego zakresu należy wybrać uwzględniając warunki obróbki takie jak, obrabiany materiał, krawędź skrawającą (płytkę), długość wystawienia, wrzeczono obrabiarki. Od prędkości 8000 obr. i powyżej, oprawka podstawowa i przedłużki powinny być wyważone dokładnie.

Instrukcje rozwiązywania problemów

Problem	Prawdopodobna przyczyna	Rozwiązanie
Nieodpowiednia kontrola wiórów	Za mała wartość posuwu	Zwiększyć posuw.
	Za duża głębokość skrawania	Użyć metody niesymetrycznej
Drgania	Nadmierna prędkość	Zmniejszyć prędkość skrawania, nie zmieniać posuwu Skrócić narzędzie w celu zwiększenia sztywności
	Zbyt duży stosunek L/D	Zwiększyć średnice trzpieni elementów pośrednich
		Użyć oprawki Steadyline Użyć przedłużek z węgla lub ciężkiego metalu
	Zbyt duży promień naroża	Użyć płytki o mniejszym promieniu
	Niestabilne mocowanie detalu	Poprawić mocowanie w przyrządzie
	Kąt przystawienia $\kappa = 80^\circ$	Zmienić $\kappa=90^\circ$, typ płytki CC
Wykruszanie się lub łamanie krawędzi płytki	Nieprawidłowa płytka	Zmienić na płytkę z bardziej ciągliwego węgla Zastosować większy promień, o ile to możliwe
	Mocno przerywana obróbka	Ograniczyć prędkość, zmniejszyć posuw
	Nieprawidłowe usuwanie wiórów	Sprawdzić luz głowica/średnica otworu Poprawić kontrolę wiórów, zwiększyć posuw
Mała trwałość ostrza	Nieprawidłowa płytka	Zmienić na płytkę z gatunku bardziej odpornego na ścieranie
	Nadmierna prędkość skrawania	Zmniejszyć prędkość
	Wykruszanie się płytki	Sprawdzić głębokość skrawania i posuw
	Zbyt niskie ciśnienie chłodziwa	Zwiększyć ciśnienie
Wióry nie są usuwane	Zbyt duże narzędzie	Zastosować mniejszą głowicę z przedłużką, jeśli możliwe.
	Za duża głębokość skrawania	Użyć metody niesymetrycznej; zastosować płytki CC.. zamiast CN..(głównie podczas wytaczania małych otworów).
	Nieodpowiednia ilość miejsca pod otworem	Położyć obrabiany element wyżej na stole
	Nieodpowiednia kontrola wiórów	Patrz wyżej
Niedostateczna moc obrabiarki	Nadmierna wartość posuwu	Zredukować posuw(nie mniej niż 25% promienia naroża)
	Za duża głębokość skrawania	Użyć metody niesymetrycznej
	Niska moc obrabiarki	Obroty w zakresie niskiego momentu wrzeciona: zwiększona prędkość
		Wartość obr. w zakresie zmiany biegu: dostosować obroty
		Zmienić na płytkę z większym kątem natarcia (np. płyt. HSS przypadkach ekstremalnych)
Zmniejszyć wartość głębokości skrawania		
Nadmierna ilość zadziórów na powierzchni wyjścia otworu	Nadmierna wartość posuwu	Zmniejszyć posuw
	Wkładki do płytek CC 90°	Użyć wkładki na płytki kwadratowe z kątem 80°
	Zbyt duże siły skrawania	Zmniejszyć wartość głębokości skrawania Zmniejszyć promień płytki

RB 610 Głowice do wytaczania zgrubnego – Ogólny opis

Połączenie Graflex®

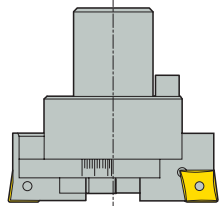

Ø 39–51 mm (Ø 1.535–2.008")

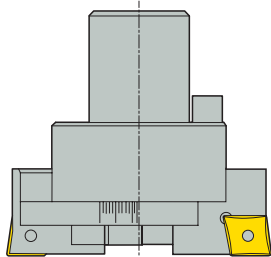

Ø 50–65 mm (Ø 1.969–2.559")

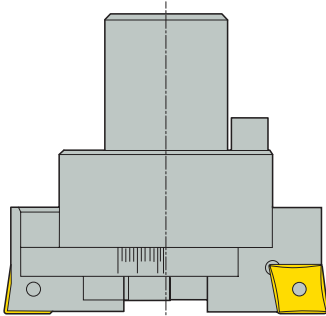

Ø 64–86 mm (Ø 2.520–3.386")

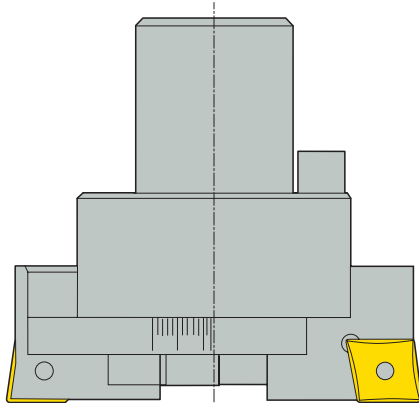

Ø 85–115 mm (Ø 3.346–4.528")

Połączenie GL

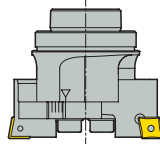

Ø 28–37 mm (Ø 1.102–1.457")

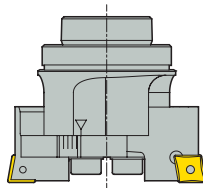

Ø 36–46 mm (Ø 1.417–1.811")

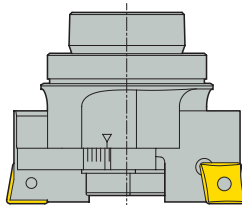

Ø 45–56 mm (Ø 1.772–2.205")

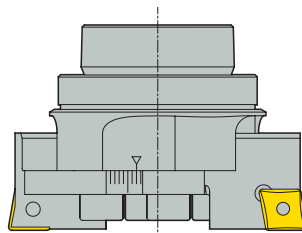

Ø 55–69 mm (Ø 2.165–2.717")

Połączenie BA

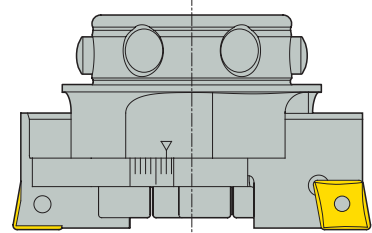

Ø 66–88 mm (Ø 2.598–3.465")

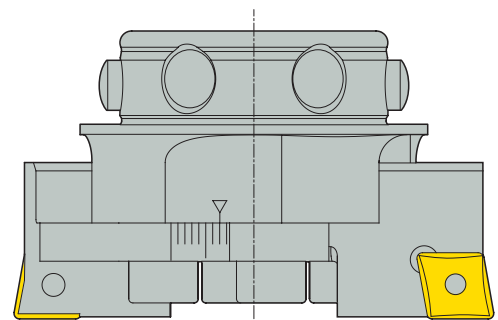

Ø 86–116 mm (Ø 3.386–4.567")

Wstęp

Wiercenie

Rozwiercanie

Wytaczanie

Zalącznik

RB 610 Głowice do obróbki zgrubnej - Poradnik

Właściwości

- Zespół głowicy do wytaczania wstępnego stanowi połączenie 1 korpusu (głowicy) i 2 wkładek na płytce
- Pozwala uzyskać precyzyjny otwór, zaczynając od otworu surowego
- Symetryczna konstrukcja minimalizuje niewyważenie

Kompaktowa konstrukcja

- Krótka konstrukcja maksymalizuje sztywność narzędzia i zapewnia lepsze możliwości tłumienia drgań przy użyciu oprawki Steadylite®
- Zredukowana waga to mniejsze przeciążenia przy wymianie narzędzia i rozpędzaniu się wrzeczona

Intuicyjne i szybkie ustawianie

- Każda wkładka jest wyposażona we własny mechanizm co umożliwia szybką i łatwą regulację
- Pozycja wkładki wskazuje nastawioną średnicę na skali

Wkładki na płytce

- Wkładki A610...CC... posiadają 90° kąt przystawienia dla romboidalnych płytek kąt natarcia 0° i kąt inklinacji 0°.
- Wkładki pasują do głowic RB 610 Graflex® oraz RB 610 GL

Produktywność

- Duża sztywność narzędzia dzięki mocnemu mocowaniu wkładek do korpusu
- Możliwość uzyskania głębokości skrawania aż do połowy długości płytki, maksymalizuje szybkość usuwania materiału oraz stopień wykorzystania płytki
- Wytaczanie niesymetryczne jest możliwe dzięki podkładce (dostarczanej razem z głowicą) włożonej pod jedną wkładkę, celem zwiększenia szybkości usuwania materiału lub podziału głębokości skrawania
- Otwory doprowadzające chłodziwo na ostrze

Asortyment

- Głowice do wytaczania wstępnego RB 610 są dostępne z połączeniem Graflex® po stronie obrabiarki, do konwencjonalnych operacji wytaczania do długości wystawienia 6xD,
- głowice do wytaczania wstępnego RB 610 z połączeniami GL i BA po stronie obrabiarki są przeznaczone do długich wysięgów z wytaczakami z tłumikiem drgań Steadylite®.

RB 610 Graflex®



- Graflex®: 4 kompaktowe głowice zgrubne od Ø 39-115 mm (Ø 1.535-4.528")
- Elastyczny system Graflex® umożliwia złożenie optymalnego narzędzia zaczynając od oprawki Graflex® poprzez elementy pośrednie, kończąc na głowicy

Głowice RB 610 GL oraz BA do Steadylite® z systemem tłumienia drgań



GL



BA

- GL: 4 krótkie i kompaktowe głowice do obróbki zgrubnej, do Ø 28-69 mm (Ø 1.102-2.717")
- BA: 2 krótkie i kompaktowe głowice zgrubne, do Ø 66-116 mm (Ø 2.598-4.567")
- Szczególnie nadają się do mocowania w wytaczakach Steadylite®. Wydajność pracy długiego zestawu z oprawką Steadylite® GL jest podobna do wydajności krótszego zestawu bez tłumika (<6xD).

RB 610 Głowice do obróbki zgrubnej - Poradnik

Ustawienie wytaczania symetrycznego:

Wytaczanie symetryczne oznacza, że obie krawędzie skrawające ustawione są na tę samą średnicę.

Ustawienie wytaczania niesymetrycznego:

Wytaczanie niesymetryczne oznacza, że jedna krawędź skrawająca jest wysunięta jako główna krawędź (pierwsza zagłębia się w materiał), pracująca na mniejszej średnicy niż druga, ustawiona na średnicę gotowego otworu: To wymaga użycia podkładki (część dostarczana z głowicą) pomiędzy głowicą a wkładką płytki zapewniająca wymagane przesunięcie (+) osiowe jednego ostrza.

Nr katalogowy podkładki	Grubość (mm)	Grubość (cale)
AU6101003	0,2	0.008
AU6103003	0,4	0.016
AU6104003	0,5	0.020
AU6105003	0,6	0.024
AU6106003	0,6	0.024

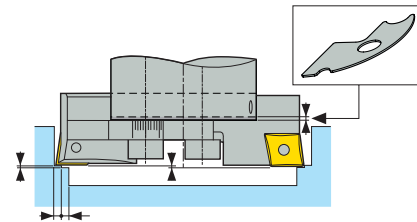
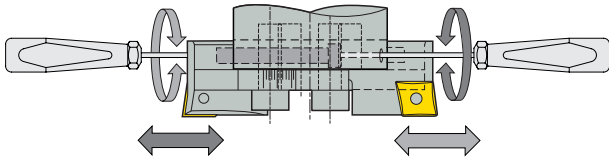

RB610

Graflex®

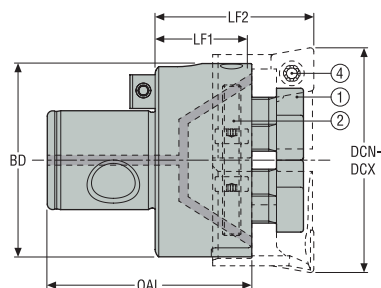

- 1. Śruba mocująca i klucz zaciskowy
- 2 & 4. Włożyć klucz do ustawiania średnicy i włożyć zacisk mocujący

- Możliwe jest wytaczanie symetryczne i stopniowe
- Mechanizm regulacji indywidualnego wkładki płytki
- Wewnętrzne podawanie chłodziwa w kierunku krawędzi skrawającej

Oznaczenie	Numer produktu	Wielk. Graflex	Od strony detalu Zakres DCN-DCX Ø		OAL	LF1	LF2	BD	Waga	Maks. obroty*
			mm	mm						
A61030	02904453	G3	39,0 1.535	51,0 2.008	43,5 1.713	23,5 0.925	36,4 1.433	34,0 1.339	0,18 0.400	7500
A61040	02904454	G4	50,0 1.969	65,0 2.559	45,5 1.791	21,5 0.846	35,3 1.390	43,0 1.693	0,27 0.600	5700
A61050	02904455	G5	64,0 2.520	86,0 3.386	55,0 2.165	25,0 0.984	42,3 1.665	54,0 2.126	0,54 1.190	4500
A61060	02904457	G6	85,0 3.346	115,0 4.528	69,0 2.717	29,0 1.142	47,8 1.882	63,0 2.480	0,93 2.050	3500

Wkładki należy zamawiać oddzielnie, patrz strona(y) 582

* Dodatkowe informacje na temat maksymalnej prędkości obrotowej, można znaleźć na stronach z instrukcjami. Uwaga: Waga podana bez wkładki

Części zamienne, zawarte w dostawie

Do głowicy	Śruba mocująca	Podkładka, ustawienie z wyprzedzeniem	Zabierak
A61030	950DC0616	AU6103003	90M31
A61040	950D0616	AU6104003	90M41
A61050	950D0820	AU6105003	90M51
A61060	950D0822	AU6106003	90M61

Akcesoria

Do głowicy	Klucz mocujący	Klucz (Typu T)
A61030	03HL05	DOUBLE-T
A61040	03HL05	DOUBLE-T
A61050	03HL06	DOUBLE-T
A61060	03HL06	DOUBLE-T

Wstęp

Wiercenie

Rozwiercanie

Wytaczanie

Złączenie

RB610 Compact

GL

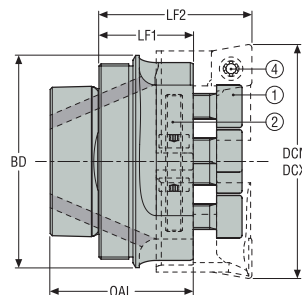

- Przeznaczony do wytaczaków GL25, GL32, GL40 i GL50 Steadyline®
- Możliwe jest wytaczanie symetryczne i stopniowe
- Mechanizm regulacji indywidualnego wkładki płytki
- Wewnętrzne podawanie chłodziwa w kierunku krawędzi skrawającej

1. Śruba mocująca i klucz zaciskowy
- 2 & 4. Włożyć klucz do ustawiania średnicy i włożyć zacisk mocujący

Oznaczenie	Numer produktu	Wielk. GL	Od strony detalu Zakres DCN-DCX		OAL	LF1	LF2	BD	Waga	Maks. obroty*
			mm	mm						
GL25-RB610-10	03307854	GL25	28,0 1.102	37,0 1.457	21,7 0.854	16,2 0.638	25,0 0.984	25,0 0.984	0,1 0.220	9500
GL32-0610-20	02904458	GL32	36,0 1.417	46,0 1.811	27,6 1.087	21,1 0.831	32,0 1.260	32,0 1.260	0,1 0.220	7500
GL40-0610-30	02904459	GL40	45,0 1.772	56,0 2.205	31,6 1.244	22,1 0.870	35,0 1.378	40,0 1.575	0,2 0.440	5700
GL50-0610-40	02904460	GL50	55,0 2.165	69,0 2.717	33,7 1.327	22,2 0.874	36,0 1.417	50,0 1.969	0,3 0.660	4500

Wkładki należy zamawiać oddzielnie, patrz strona(y) 582

* Dodatkowe informacje na temat maksymalnej prędkości obrotowej, można znaleźć na stronach z instrukcjami. Uwaga: Waga podana bez wkładki

Części zamienne, zawarte w dostawie

Do głowicy	Śruba mocująca	Podkładka, ustawienie z wyprzedzeniem
GL25-0610-10	950D0410	AU6101003
GL32-0610-20	950DC0412	AU6102003
GL40-0610-30	950DC0616	AU6103003
GL50-0610-40	950D0616	AU6104003

Akcesoria

Do głowicy	Klucz mocujący	Klucz do płytki	Klucz (Typu T)
GL25-0610-10	03HL03	T07P-3	-
GL32-0610-20	03HL03	H4B-T07P	DOUBLE-T
GL40-0610-30	03HL05	-	DOUBLE-T
GL50-0610-40	03HL05	-	DOUBLE-T

Wstęp

Wiercenie

Rozwiercanie

Wytaczanie

Załącznik

RB610

BA

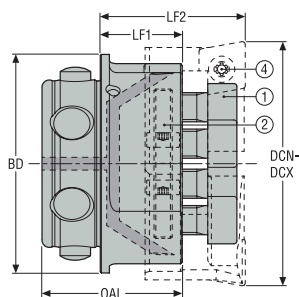

- 1. Śruba mocująca i klucz zaciskowy
- 2 & 4. Włożyć klucz do ustawiania średnicy i włożyć zacisk mocujący

- Przeznaczony do wytaczaków BA60, GL32, GL40 i BA80 Steadyline®
- Możliwe jest wytaczanie symetryczne i stopniowe
- Mechanizm regulacji indywidualnego wkładki płytki
- Wewnętrzne podawanie chłodziwa w kierunku krawędzi skrawającej

Oznaczenie	Numer produktu	Wielk. BA	Od strony detalu		Zakres DCN-DCX Ø	OAL	LF1	LF2	BD	Waga	Maks. obroty*
			mm	mm							
BA060-RB610-50	03204092	BA060	66,0 2.598	88,0 3.465	38,5 1.516	22,5 0.886	39,8 1.567	60,0 2.362	0,8 1.760	4000	
BA080-RB610-60	03204093	BA080	86,0 3.386	116,0 4.567	44,5 1.752	22,5 0.886	41,3 1.626	80,0 3.150	1,1 2.430	3000	

Wkładki należy zamawiać oddzielnie, patrz strona(y) 582

* Dodatkowe informacje na temat maksymalnej prędkości obrotowej, można znaleźć na stronach z instrukcjami. Uwaga: Waga podana bez wkładki

Części zamienne, zawarte w dostawie

Do głowicy	Klucz mocujący	Śruba mocująca	Klucz (Typu T)	Podkładka, ustawienie z wyprzedzeniem
BA060-RB610-50	03HL06	950D0820	DOUBLE-T	AU6105003
BA080-RB610-60	03HL06	950D0822	DOUBLE-T	AU6106003

Wstęp

Wiercenie

Rozwiercanie

Wytaczanie

Złączenie

Wkładki płytek

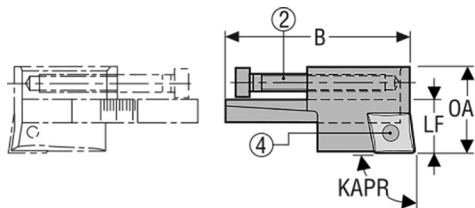
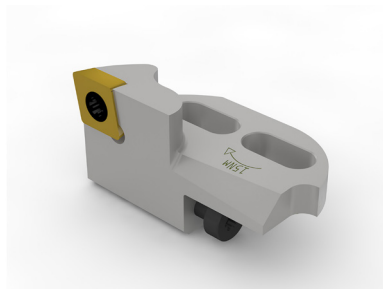

- Nadaje się do głowic wytaczarskich RB 610 z połączeniem Graflex®, GL lub BA

- 2. Śruba regulacyjna
- 4. Śruba mocująca płytkę

Oznaczenie	Numer produktu	Do głowicy	Od strony detalu Zakres DCN-DCX Ø		OAL	LF	B	Waga
			mm	mm				
A61010CC0690	03307856	RB 61010	28,0 1.102	37,0 1.457	15,1 0.594	15,1 0.594	21,75 0.856	0,1 0.220
A61020CC0690	02971268	RB 61020	36,0 1.417	46,0 1.811	17,6 0.693	10,9 0.429	26,0 1.024	0,1 0.220
A61030CC0990	02904461	RB 61030	39,0 1.535	56,0 2.205	17,6 0.693	12,9 0.508	33,0 1.299	0,1 0.220
A61040CC0990	02904462	RB 61040	50,0 1.969	69,0 2.717	22,5 0.886	13,8 0.543	43,8 1.724	0,1 0.220
A61050CC1290	02904463	RB 61050	64,0 2.520	86,0 3.386	22,5 0.886	17,3 0.681	57,4 2.260	0,2 0.440
A61060CC1290	02904464	RB 61060	85,0 3.346	115,0 4.528	27,5 1.083	18,8 0.740	75,0 2.953	0,2 0.440

Części zamienne, zawarte w dostawie

Do wkładki	Śruba do płytki	Śruba ustawcza
A61010CC0690	C02504-T07P	-
A61020CC0690	C02504-T07P	19A61020
A61030CC0990	C04008-T15P	19A61030
A61040CC0990	C04008-T15P	19A61040
A61050CC1290	C05012-T15P	19A61050
A61060CC1290	C05012-T15P	19A61060

Zalecane płytki do wytaczania zgrubnego - patrz str. 654

Uwaga: Klucz do mocowania śruby płytki jest częścią zawartości dostarczonej głowicy RB 610.

RB 610 Głowice do obróbki zgrubnej - Instrukcje

Zalecane momenty dokręcania. Maks. posuw na obr. przy wytaczaniu stopniowym

Głowice RB 610 wielkości	30	40	50	60
Moment dokręcania śruby mocującej wkładki płytek (Nm)	2 x 25	4 x 25	4 x 40	4 x 40
Maks. posuw na obrót przy wytaczaniu niesymetrycznym mm/obr. (cale/obr.)	0,4 (0.016 ")	0,5 (0.020 ")	0,6 (0.024 ")	0,6 (0.024 ")

Zalecane warunki obróbki

Moc wrzeciona:

Ponieważ zgrubne wytaczanie wymaga dużej mocy obrabiarki, zalecamy sprawdzenie, czy obrabiarka dysponuje odpowiednią mocą. Niesymetryczne wytaczanie to rozwiązanie pozwalające ograniczyć zapotrzebowanie na moc, gdyż posuw jest podzielony na dwa przy takiej samej łącznej głębokości skrawania, w porównaniu do ustawienia symetrycznego. Najlepsze wyniki uzyskuje się przy doprowadzeniu chłodziwa na ostrze (wyższe parametry, lepsze wykańczanie powierzchni, lepsze usuwanie wiórów, większa trwałość ostrza).

Szczegółowe instrukcje, patrz informacje dostarczane razem z głowicami wytaczarskimi oraz oprawkami Steadyline®. Instrukcje można także pobrać ze strony www.secotools.com.

Prędkości maksymalne dla głowic RB 610 do wytaczania zgrubnego

UWAGA! Maksymalne prędkości pokazane na stronach produktów dotyczą samej konstrukcji oraz jakości wyważenia głowicy.

Zastosowana prędkość powinna także uwzględniać inne warunki pracy np. obrabiany materiał, płytkę, długość narzędzia, wrzeciono obrabiarki.

Podczas wytaczania z użyciem oprawki Steadyline®, nie można przekroczyć maksymalnych obrotów oprawki: Patrz instrukcje dostarczone razem z oprawką Steadyline®.



Wytaczanie wykańczające

Asortyment produktów Seco do wytaczania precyzyjnego, obejmuje szeroki zakres wielkości otworów i materiałów, zapewniają precyzyjną regulację w pojedynczych mikronach, gładkość powierzchni $Ra < 1$ (RMS 44 mikro/cal) oraz tolerancję otworów IT6. Dzięki konsekwentnemu skupieniu się na precyzji i sztywności produkty te ułatwiają utrzymanie nawet najsurowszych specyfikacji części. Rozwiązania z zakresu tłumienia drgań Steadyline™ uzupełniają ofertę, zapewniając jeszcze większą stabilność podczas obróbki zagłębień, gdzie wymagane są długie wysięgi.

- Głowice precyzyjne FB 760 typu Axiabore są przeznaczone do wykańczania małych średnic
- Głowice promieniowe FB 620/780/790 zapewniają najlepszą geometrię otworów o większych średnicach (do 205 mm)

Ogólny opis



Do obtaczania średnicy



Obróbka rowków

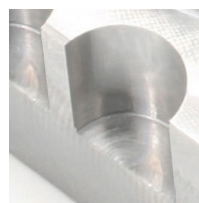

Wytaczanie przerwane



Wytaczanie

Ogólny opis

Wstęp

Wiercenie

Rozwiercanie

Wytaczanie

Załącznik

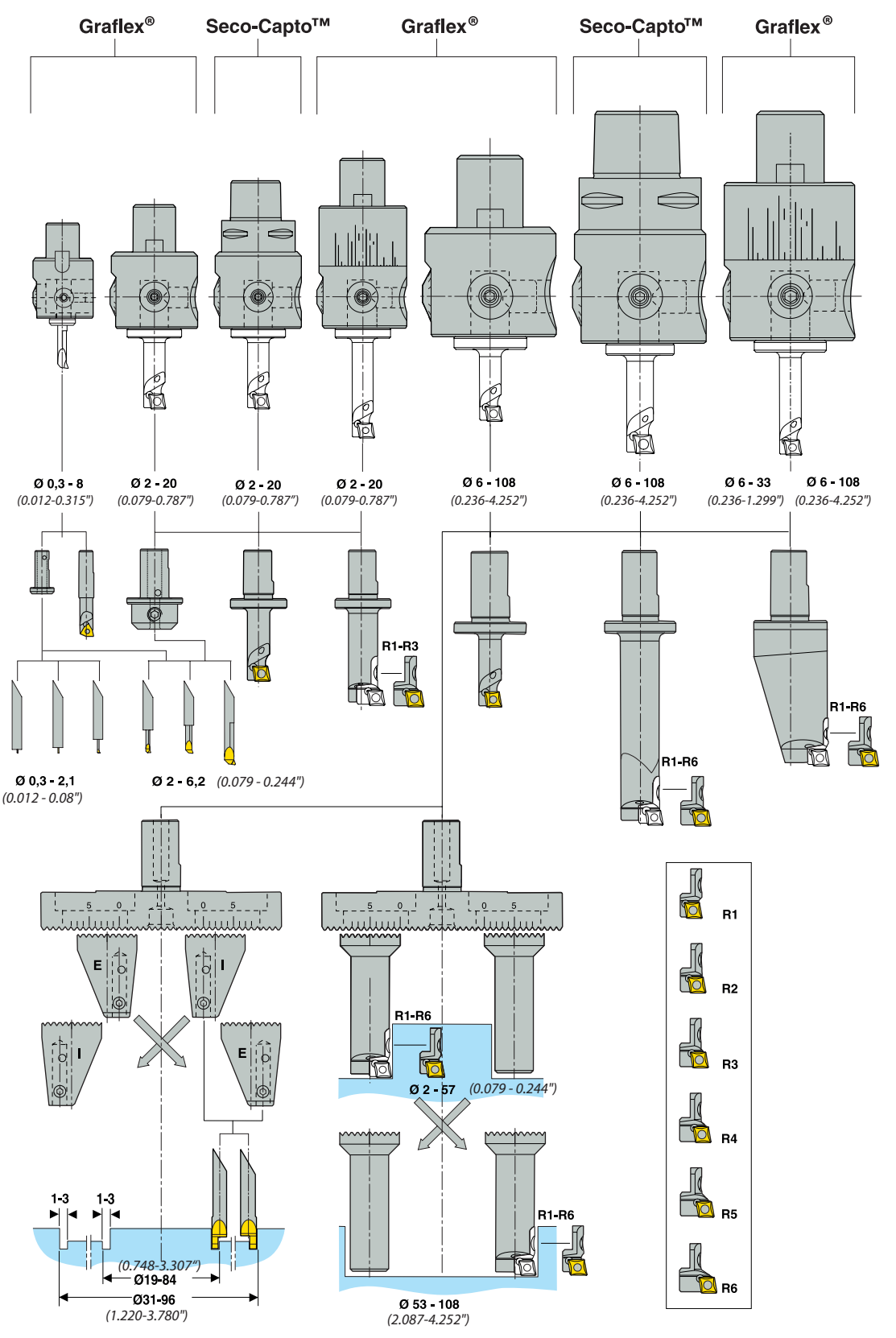

Głowice do wytaczania wykańczającego Axiabore™ do otworów Ø 0,3–108 mm (0.012–4.252")

Głowica typu Axiabore™ składa się z korpusu (głowicy) oraz wytaczaka.

Wybór głowicy typu Axiabore™	Zakres Ø mm	Zakres Ø cale	HSM/Maks. prędkość	Geometria otworu	Efektywność kosztowa	Wielozadaniowość
Nanobore™ A760 01	0,3-8	0.012–0.315"	30000 obr/min	■ ■	■ ■	
Axiabore™ A760 02	2-20	0.079–0.787"	12000 obr/min	■	■ ■	
Axiabore™ Plus - A760 03	6-108	0.236–4.252"	8000* obr/min lub 1000 m/min	■	■ ■ ■	■ ■ ■
Axiabore™ Plus C5-391.0760-03	6-108	0.236–4.252"	8000* obr/min	■	■ ■ ■	■ ■ ■
Axialibrabore™ Plus - A760 13	6-33	0.236–1.299"	20000 obr/min lub 1500 m/min	■ ■	■	

Głowice Axiabore™ dostępne są z połączeniami Graflex® lub Seco-Capto™: 5 głowic Axiabore™ FB 760 do wytaczania precyzyjnego z połączeniem Graflex® do otworów Ø 0,3–108 mm (0.012–4.252")

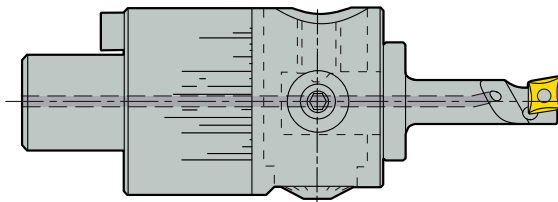

Nanobore™ A760 01
 Axiabore™ A760 02
 Axialibrabore™ A760 12
 Axiabore™ Plus — A760 03
 Axialibrabore™ Plus — A760 13

2 głowice Axiabore™ do wytaczania na gotowo FB 760 z połączeniem Seco-Capto™: Ø 2–108 mm (0.079–4.252")

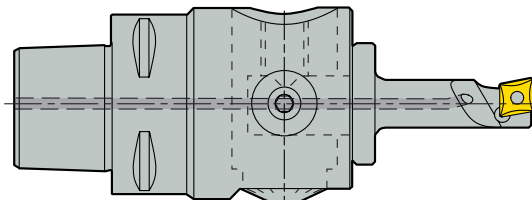

Axiabore™ C3-391.0760-02
 Axiabore™ Plus- C5-391.0760-03

UWAGA! Minimalna średnica otworu dla głowicy na gotowo Seco-Capto™ wynosi Ø 2 mm (Ø 0.079") z najmniejszym dostępnym mocowaniem Seco-Capto™ C3. W zakresie Ø 0,3–8 mm (0.012-0.315") należy stosować głowice Nanobore™ z połączeniem G2 oraz odpowiednim adapterem Seco-Capto™/Graflex®.

Adapter Seco-Capto™ i głowice Graflex®: Ø 0,3–8 mm (Ø 0.012–0.315")

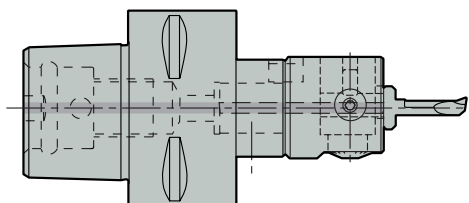

Adaptory i przedłużki modułowe Graflex® i Seco-Capto™: patrz katalog Systemy narzędziowe.

UWAGA! Opisy, instrukcje (procedura mocowania narzędzia, nastawianie średnicy, mocowanie adaptera MPA, wytaczanie wsteczne, rozwiązywanie problemów, zalecane parametry, maksymalne prędkości), odpowiednie wkładki oraz płytki są podobne dla obu typów głowic FB 760 w odpowiednich zakresach, bez względu na typ połączenia.

Narzędzia do wytaczania

Uwaga! Na stronach przedstawiających produkty, wyraźnie wskazano, które narzędzia pasują do poszczególnych głowic.

Narzędzia do wytaczania, chwyt z węgla spiekanego Ø 4 mm (Ø 0.1574") do najmniejszych średnic Ø 0,3–6,2 mm (Ø 0.012–0.244"), kąt przystawienia 98°. Wymagają tulejek redukcyjnych do zamocowania w głowicach Nanobore™ i Axia(libra)bore™. Wytaczaki posiadają ścięcia na chwycie w celu zorientowania krawędzi skrawającej, zgodnie z ISO.

Wytaczadła na płytce Ø 6, 12 lub 16 mm (Ø 0.236, 0.472, 0.630") do Ø 6–13 mm (Ø 0.236–0.512"), stalowe do krótkich wysięgów, węglkowe do długich wysięgów. Do płytek WB..0301.. lub CC..0602.. i kąta przystawienia 90°. Bezpośredni montaż w głowicach. Spłaszczenie mocujące orientuje krawędź skrawającą, zgodnie z ISO.

Wytaczadła modułowe, składające się z „chwytu” i „wkładki na płytkę” do Ø 13–63 mm (Ø 0.512–2.480"). Chwyty Ø 12 lub 16 mm (Ø 0.472, 0.630") stalowe do krótkich otworów, węglkowe do długich otworów i z „lekkich stopów / aluminium” do dużych średnic. Bezpośredni montaż w głowicach.

Sześć wkładek do płytek CC..0602.. i z kątem przystawienia 90°, kompatybilnych ze wszystkimi oprawkami, w celu zapewnienia szerokiego zakresu wytaczania z powszechnie używanymi oprawkami.

Adapter wielofunkcyjny (MPA)

Adapter wielofunkcyjny do wytaczania otworów oraz obróbki średnic zewn., oraz obróbki czola z głowicą - Axiabore™ Plus-głowica. Adapter i części składowe posiadają połączenie wielokarbowe, które umożliwia symetryczne ustawienie oraz zmianę ustawienia średnicy ze skokiem 2,5 mm na średnicy (0.098"). Zawiera dyszę bezpośrednio doprowadzającą chłodziwo.

Wybrać elementy składowe do zbudowania adaptera MPA (adapter wielofunkcyjny) w tabelach z asortymentem narzędzi MPA. Zapoznać się ze szczegółami dotyczącymi montażu w rozdziale Instrukcje.

Budowa zestawu do wytaczania lub obtaczania średnicy zewnętrznej
W zestawach do wytaczania i do obtaczania średnicy zewnętrznej stosowany jest ten sam chwyt wyposażony we wkładkę oraz przeciwiężar. Zestaw do wytaczania/ obtaczania średnicy zewnętrznej, korzystając z tabeli z asortymentem wkładek 'Wytaczanie' (na następnych stronach z produktami).

Zestaw do obtaczania: Wybrać odpowiednią wkładkę do zamontowania w chwycie do wytaczania/obtaczania średnicy zewnętrznej, korzystając z tabeli z asortymentem wkładek 'do obtaczania średnicy zewnętrznej' (na następnych stronach z produktami). Zapoznać się ze szczegółami dotyczącymi montażu w rozdziale Instrukcje.

Zestaw do wykonywania rowków

Zestaw do obróbki rowków wokół czopu zawiera:

- Para opravek narzędzi do rowkowania (jedna E = „zewnętrzna” i jedna I = „wewnętrzna”)
- Jedno narzędzie do rowkowania „w kierunku trzpienia” lub „w kierunku otworu”. Jeśli rowek nie jest skierowany w stronę ściany z trzpieniem ani w stronę ściany z otworem, można stosować oba typy narzędzi. Patrz tablica doboru "Narzędzia do rowkowania z adapterem MPA"

Właściwości

Głowica Nanobore™, oznaczenie A76001



Bardzo mała głowica do wytaczania precyzyjnego \varnothing 0,3–8 mm (\varnothing 0.012–0.315”):

Średnica zewnętrzna 25 mm (0.984”), długość 25 mm (0.984”), z połączeniem Graflex® o wielkości G2, mocowanie narzędzia \varnothing 6 mm (\varnothing 0.236”). Prędkości robocze do 30 000 obr./min zapewniają wydajną obróbkę otworów o bardzo małych średnicach.

Tulejka redukcyjna 6-4 mm (0.236-0.157”) ze splaszczaniem zapewniającym właściwe ustawienie oraz kolkiem do mocowania wytaczadeł monolitycznych jest dostarczana wraz z głowicą.

Głowica Axiabore™, oznaczenie A76002



Małe głowice do wytaczania precyzyjnego \varnothing 2–20 mm (\varnothing 0.079–0.787”):

Średnica zewnętrzna 36,5 mm (1.401”), długość 32 mm (1.260”), z połączeniem Graflex® o wielkości G3 i Seco-Capto™ o wielkości C3, mocowanie narzędzia \varnothing 12 mm (\varnothing 0.472”). Wielkości głowic są zoptymalizowane pod kątem trudno dostępnych otworów.

Tulejka redukcyjna 12-4 mm (0.472-0.157”) ze splaszczaniem zapewniającym właściwe ustawienie oraz kolkiem do mocowania wytaczadeł monolitycznych jest dostarczana wraz z głowicą.

UWAGA! Mniejsze narzędzia Nanobore™ 0,3–2,1 mm (0.012–0.083”) mogą być także mocowane, jednak prędkość skrawania zostanie ograniczona do 12 000 obr./min: Najlepiej stosować głowicę Nanobore®.

Axiabore™ Plus - głowice, oznaczenie A76003 i C5-391.0760-03



Głowice uniwersalne do wytaczania precyzyjnego \varnothing 6–108 mm (\varnothing 0.236–4.252”), toczenia średnic zewnętrznych \varnothing 2–57 mm (\varnothing 0.079–2.244”) i rowkowania \varnothing 19–96 mm (\varnothing 0.748–3.780”):

Średnica zewnętrzna 54 mm (\varnothing 2.126”), długość 45 mm (1.772”), z połączeniem Graflex® o wielkości 5 i Seco-Capto™ o wielkości 5, mocowanie narzędzia \varnothing 16 mm (\varnothing 0.630”).

Odpowiednie narzędzia: wszystkie narzędzia z chwytem \varnothing 16 mm (\varnothing 0.630”), do bezpośredniego mocowania w głowicach.

Głowica ta może również współpracować z wielofunkcyjnym adapterem MPA, przy operacjach wytaczania na gotowo dużych średnic, toczenia średnic zewnętrznych oraz kanalków czolowych.

Głowica Axialibrabore™ Plus - oznaczenie A76013



Głowica do wytaczania precyzyjnego z możliwością wyważenia \varnothing 6–33 mm (\varnothing 0.236–1.299”):

Takie same właściwości jak w przypadku głowicy Axiabore™ Plus, ale z korpusem długość 65 mm (2.559”).

Z połączeniem Graflex® wielkość G5.

Głowice z możliwością dokładnego wyważenia umożliwiają zwiększenie obrotów do 20 000 obr/min lub 1 500 m/min (bez względu na to, która z tych wartości zostanie osiągnięta jako pierwsza, jednak nie przekraczając żadnej z nich), polepszają geometrię otworu oraz zmniejszają naprężenie wrzeciona.

'Wyważenie LibraOne' wykonywane jest poprzez ustawienie pierścienia wyważającego z podziałką w jednej linii z oznaczeniem na głowicy do wytaczania (zgodnie z oznaczeniem wyważania właściwym dla używanego narzędzia oraz średnicą otworu). Nie jest wymagane korzystanie z tabeli.

Dokładne wyważenie jest możliwe tylko w przypadku najmniejszych narzędzi do wytaczania \varnothing 6–33 mm (\varnothing 0.236–1.299”).

UWAGA! Uwaga: stosując duże narzędzia 'Alu', lub 'MPA' z - Axiabore™ Plus - na głowicy - Axialibrabore™ Plus -, nie mamy możliwości wyważenia i pierścień wyważający powinien być ustawiony w pozycji wyważenia wstępnego (zależnie od operacji, patrz instrukcje). Maksymalna prędkość jest taka sama jak w przypadku - Axiabore™ Plus.

FB 760 – główce typu Axiabore™, bez możliwości wyważenia

Graflex®

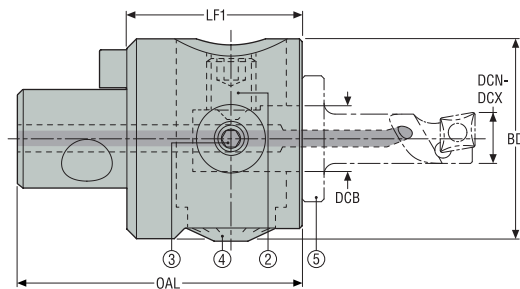

- Z regulacją mikrometryczną (skok 0,01 mm i noniusz 2,5 µm, na średnicy)
- Axiabore™ Plus – umożliwia wytaczanie, a także obtaczanie i toczenie rowków czolowych

3. Śruba mocująca
4. Mikrometryczna śruba regulacyjna
2. Śruba montażowa
5. Narzędzie

Oznaczenie	Numer produktu	Wielk. Graflex	Od strony detalu Zakres DCN-DCX Ø		*	OAL	LF1	BD	DCB	Waga	Maks. prędk. skraw.**		***
			mm Cal.	mm Cal.							Maks. obroty**	Maks. m/min**	
A76001	02462575	G2	0,3 0.012	8,0 0.315	-	41,0 1.614	25,0 0.984	25,0 0.984	6,0 0.236	0,1 0.220	30000	1500,0	-
A76002	02594930	G3	2,0 0.079	20,0 0.787	-	52,0 2.047	32,0 1.260	36,5 1.437	12,0 0.472	0,29 0.640	12000	1500,0	-
A76003	02594935	G5	6,0 0.236	108,0 4.252	*	75,0 2.953	45,0 1.772	54,0 2.126	16,0 0.630	0,82 1.810	8000	1000,0	***

Uwaga: Waga podana bez wkładki

Narzędzia, patrz str. 593-595

*Zakresy - Axiabore™ Plus - Głowica do wytaczania 6-108 mm (0.236-4.252"), obtaczania 2-57 mm (0.079-2.244"), toczenia rowków czolowych 19-96 mm (0.748-3.780").

**Prędkość maksymalna, w zależności od tego, która z wartości zostanie osiągnięta wcześniej, bez przekraczania którejkolwiek.

***Maks. 5000 obr./min w przypadku korzystania z MPA.

Części zamienne, zawarte w dostawie

Do głowicy	Śruba mocująca	Klucz (Typu T)	Klucz	Śruba mocująca	Tulejka redukcyjna	Śruba uszczelniająca	Zabierak
A76001	-	DOUBLE-T	H4B-H2.0	19M4001A	05A7600604	950A0406	90M21
A76002	AU7601212	-	03M03C	19A71030	05A7601204	-	90M3A
A76003	AU7601312	DOUBLE-T	H6B-H4.0L	19A71008125	-	-	90M5A

Akcesoria

Do głowicy	Szko powiększające	Stojak	Klucz dynamometryczny do śruby blokującej pierścieni wyważający	Klucz dynamometryczny do śrub mocujących
A76001	935L01	-	-	H00-2009
A76002	-	42M06	-	H00-3030
A76003	-	42M07	H00T-4060	-

Akcesoria, należy zamawiać osobno

Wstęp

Wfoczenie

Rozwiercanie

Wytaczanie

Załącznik

FB 760 – głowice typu Axiabore™, z możliwością wyważenia

Graflex®

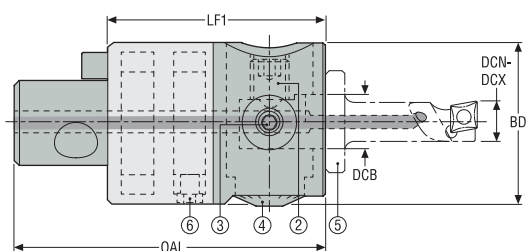

6. Śruba mocująca 2
3. Śruba mocująca 1
4. Mikrometryczna śruba regulacyjna
2. Śruba montażowa
5. Narzędzie



- Wbudowany system wyważający LibraOne oparty na pojedynczym pierścieniu do wyważania
- Z regulacją mikrometryczną (skok 0,01 mm i noniusz 2,5 µm, na średnicy)

Oznaczenie	Numer produktu	Wielk. Graflex	Od strony detalu Zakres DCN-DCX Ø		*	OAL	LF1	BD	DCB	Waga	Maks. prędk. skraw.**	
			mm Cal.	mm Cal.							Maks. obroty**	Maks. m/min**
A76013	02594943	G5	6,0 0.236	33,0 1.299	*	95,0 3.740	65,0 2.559	54,0 2.126	16,0 0.630	1,16 2.560	20000	1500

Uwaga: Waga podana bez wkładki

Narzędzia, patrz str. 593-595

*Zakresy – Axialibrabore™ Plus – głowica z wyważeniem.

**Prędkość maksymalna, w zależności od tego, która z wartości zostanie osiągnięta wcześniej, bez przekraczania którejkolwiek.

Części zamienne, zawarte w dostawie

Do głowicy	Śruba mocująca	Klucz (Typu T)	Klucz	Śruba mocująca 1	Śruba mocująca 2	Zabierak
A76013	AU7601312	DOUBLE-T	H6B-H4.0L	19A71008125	AU7601318	90M5A1

Akcesoria

Do głowicy	Stojak	Klucz dynamometryczny do śruby blokującej pierścień wyważający	Klucz dynamometryczny do śrub mocujących
A76013	42M07	H00-4020-60	H00T-4060

Akcesoria, należy zamawiać osobno

Wstęp

Wiercenie

Rozwiercanie

Wytaczanie

Złączenie

FB 760 – główce typu Axiabore™

Seco-Capto™

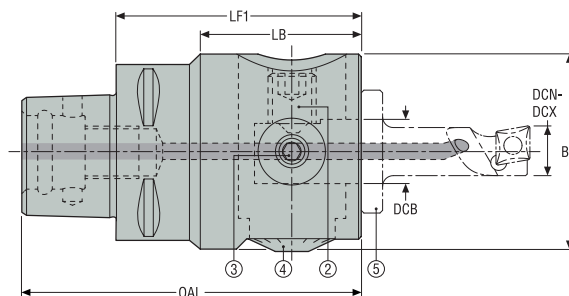

- Z regulacją mikrometryczną (skok 0,01 mm i noniusz 2,5 µm, na średnicy)
- Axiabore™ Plus – umożliwia wytaczanie, a także obtaczanie i toczenie rowków czołowych

3. Docisk
4. Mikrometryczna śruba regulacyjna
2. Śruba montażowa
5. Narzędzie

Oznaczenie	Numer produktu	Wielkość Capto	Od strony detalu Zakres DCN-DCX Ø		*	OAL	LF1	LB	BD	DCB	Waga	Maks. prędk. skraw.**	
			mm Cal.	mm Cal.								Maks. obroty**	Maks. m/min**
C5-391.0760-03	02822777	C5	6,0 0.236	108,0 4.252	*	95,0 3.740	65,0 2.559	44,0 1.732	54,0 2.126	16,0 0.630	1,12 2.470	8000	1500,0

Uwaga: Waga podana bez wkładki

Narzędzia, patrz str. 593-595

*Maks. 5000 obr./min w przypadku korzystania z MPA.

**Zakresy - Axiabore™ Plus - Głowica do wytaczania 6-108 mm (0.236-4.252) , obtaczania 2-57 mm (0.079-2.244) , toczenia rowków czołowych 19-96 mm (0.748-3.780).

Części zamienne, zawarte w dostawie

Akcesoria

Do głowicy	Śruba mocująca	Klucz (Typu T)	Klucz	Śruba mocująca	Klucz dynamometryczny do śrub mocujących
C5-...-03	AU7601312	DOUBLE-T	H6B-H4.0L	19A71008125	H00-3030

Akcesoria, należy zamawiać osobno

Wytaczaki węglkowe, monolityczne

Do głowic FB 760

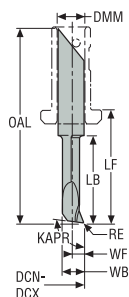

- KAPR 98°
- Orientacja krawędzi skrawającej w/g ISO
- Płyn chłodzący wzdłuż narzędzia
- Materiał narzędzia: Węgiel spiekany*

Oznaczenie	Numer produktu	Do głowicy	Zakres DCN-DCX		OAL	LB	LF	DMM	WB	WF	RE	Zalecane	Zalecane	Waga	Wyważenie
			parametry skrawania** a _p	parametry skrawania** f											
			mm	mm	mm	mm	mm	mm	mm	mm	mm	mm	mm	kg	
			Cal.	Cal.	Cal.	Cal.	Cal.	Cal.	Cal.	Cal.	Cal.	Cal.	Cal.	lbs	
A761402	02462579	FB 76001	0,3 0.012	0,6 0.024	30,7 1.209	1,2 0.047	15,5 0.610	4,0 0.157	0,25 0.010	0,1 0.004	0,0 0.0	0,02 0.001	0,01 0	0,01 0.020	-
A761412	02462581	FB 76001	0,5 0.020	1,1 0.043	30,7 1.209	2,0 0.079	15,5 0.610	4,0 0.157	0,45 0.018	0,2 0.008	0,0 0.0	0,02 0.001	0,01 0	0,01 0.020	-
A761422	02462583	FB 76001	1,0 0.039	2,1 0.083	30,7 1.209	5,0 0.197	15,5 0.610	4,0 0.157	0,95 0.037	0,45 0.018	0,1 0.004	0,03 0.001	0,02 0.001	0,01 0.020	-
A761432	02462584	FB 76001/02/12	2,0 0.079	3,2 0.126	30,7 1.209	8,0 0.315	15,5 0.610	4,0 0.157	1,8 0.071	0,88 0.035	0,1 0.004	0,05 0.002	0,02 0.001	0,1 0.220	E13
A761442	02462586	FB 76001/02/12	3,0 0.118	4,7 0.185	30,7 1.209	10,0 0.394	15,5 0.610	4,0 0.157	2,75 0.108	1,35 0.053	0,15 0.006	0,06 0.002	0,03 0.001	0,01 0.020	E14
A761452	02462587	FB 76001/02/12	4,5 0.177	6,2 0.244	35,7 1.406	15,0 0.591	20,5 0.807	4,0 0.157	3,95 0.156	1,95 0.077	0,15 0.006	0,08 0.003	0,03 0.001	0,1 0.220	E15

* Te narzędzia o średnicy chwytu 4 mm wymagają zastosowania tulei redukcyjnej, dostarczonej z odpowiednimi głowicami i kompletami.

** Prędkości skrawania, patrz str. 658-661

***+0,1 mm dodatkowy zakres.

Wytaczaki, typ płytkowy

Do głowic FB 760



- Orientacja krawędzi skrawającej w/g ISO
- Chłodzenie wewnętrzne
- Tylko dwie wielkości płytek dla wszystkich narzędzi
- Materiał narzędzia * = Stalowe, z wymienną płytką
- Materiał narzędzia ** = Wiertła węglkowe, płytkowe
- KAPR 90°

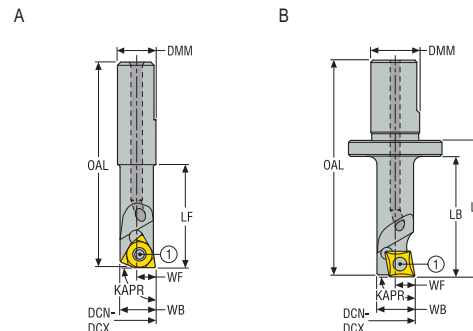

1 = Śruba mocująca płytkę

Oznaczenie	Numer produktu	Do oprawki	Do głowicy	** Zakres DCN-DCX Ø		OAL	LB	LF	DMM	WB	WF	Waga	Wersja	Odpowiednia wielkość płytki	Wyważenie
				mm	mm										
				Cal.	Cal.	Cal.	Cal.	Cal.	Cal.	Cal.	Cal.	kg			
												lbs			
A762001	02462590	*	FB 76001	6,0 0.236	8,0 0.315	31,7 1.248	0,0 -	16,0 0.630	6,0 0.236	5,5 0.217	2,9 0.114	0,1 0.220	A	WB...0301..	-
A762002	02594947	*	FB 76002/12	6,0 0.236	8,0 0.315	39,7 1.563	16,0 0.630	20,0 0.787	12,0 0.472	5,5 0.217	2,9 0.114	0,03 0.070	B	WB...0301..	S21
A762003	02594967	*	FB 76003/13	6,0 0.236	8,0 0.315	50,2 1.976	16,0 0.630	21,0 0.827	16,0 0.630	5,5 0.217	2,9 0.114	0,07 0.150	B	WB...0301..	S31
A763002	02594948	*	FB 76002/12	8,0 0.315	10,0 0.394	45,7 1.799	22,0 0.866	26,0 1.024	12,0 0.472	7,4 0.291	3,9 0.154	0,04 0.090	B	WB...0301..	S22
A763003	02594968	*	FB 76003/13	8,0 0.315	10,0 0.394	56,2 2.213	22,0 0.866	27,0 1.063	16,0 0.630	7,4 0.291	3,9 0.154	0,1 0.220	B	WB...0301..	S32
A765002	02594957	*	FB 76002/12	10,0 0.394	13,0 0.512	53,5 2.106	30,0 1.181	34,0 1.339	12,0 0.472	9,35 0.368	4,8 0.189	0,04 0.090	B	CC...0602..	S23
A765003	02594969	*	FB 76003/13	10,0 0.394	13,0 0.512	64,0 2.520	30,0 1.181	35,0 1.378	16,0 0.630	9,35 0.368	4,8 0.189	0,08 0.180	B	CC...0602..	S33
A762201	02462591	**	FB 76001	6,0 0.236	8,0 0.315	41,7 1.642	0,0 -	26,0 1.024	6,0 0.236	5,5 0.217	2,9 0.114	0,02 0.040	A	WB...0301..	-
A762202	02594958	**	FB 76002/12	6,0 0.236	8,0 0.315	50,7 1.996	27,0 1.063	31,0 1.220	12,0 0.472	5,5 0.217	2,9 0.114	0,06 0.130	B	WB...0301..	E21
A762203	02594970	**	FB 76003/13	6,0 0.236	8,0 0.315	61,2 2.409	27,0 1.063	32,0 1.260	16,0 0.630	5,5 0.217	2,9 0.114	0,13 0.290	B	WB...0301..	E31
A763202	02594961	**	FB 76002/12	8,0 0.315	10,0 0.394	60,7 2.390	37,0 1.457	41,0 1.614	12,0 0.472	7,4 0.291	3,9 0.154	0,07 0.150	B	WB...0301..	E22
A763203	02594971	**	FB 76003/13	8,0 0.315	10,0 0.394	71,2 2.803	37,0 1.457	42,0 1.654	16,0 0.630	7,4 0.291	3,9 0.154	0,14 0.310	B	WB...0301..	E32
A765202	02594962	**	FB 76002/12	10,0 0.394	13,0 0.512	78,5 3.091	55,0 2.165	59,0 2.323	12,0 0.472	9,35 0.368	4,8 0.189	0,09 0.200	B	CC...0602..	E23
A765203	02594972	**	FB 76003/13	10,0 0.394	13,0 0.512	89,0 3.504	55,0 2.165	60,0 2.362	16,0 0.630	9,35 0.368	4,8 0.189	0,2 0.440	B	CC...0602..	E33

Części zamienne, zawarte w dostawie

Aksesoria

Dla płytki o wielkości	Śruba do płytki	Klucz do płytki	Klucz (Typu T)
WB...0301..	C02035-T06P	H4B-T06P	DOUBLE-T
CC...0602..	C02504-T07P	H4B-T07P	DOUBLE-T

**+0,2 mm dodatkowy zakres.

Aksesoria, należy zamawiać osobno

Oprawki wytaczarskie do wytaczaków modułowych

Do głowic FB 760

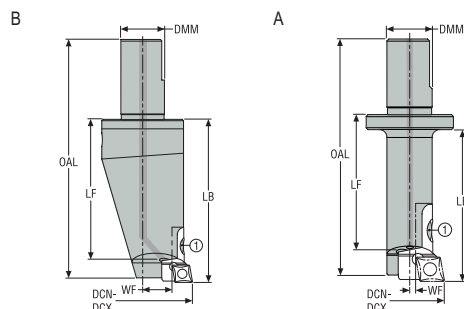

1 = Śruba mocująca



- Kilka zakresów dostępnych po wymianie wkładek
- Oprawka typu „stalowa” do krótkich narzędzi, „węglkowa” do długich narzędzi, „alumiowa” do dużych narzędzi
- Chłodzenie wewnętrzne

Oznaczenie	Numer produktu	Wytaczak modułowy	Do głowicy	** Zakres DCN-DCX Ø		OAL	LB	LF	DMM	WF	Waga	Konstrukcja	***
				mm	mm								
A760S20	02594963	Stalowy	FB 76002/12	13,0 0.512	20,0 0.787	62,5 2.461	40,0 1.575	34,0 1.339	12,0 0.472	1,4 0.055	0,1 0.220	A	
A760S30	02594973	Stalowy	FB 76003/13	13,0 0.512	18,0 0.709	73,0 2.874	40,0 1.575	35,0 1.378	16,0 0.630	1,4 0.055	0,1 0.220	A	
A760S31	02594974	Stalowy	FB 76003/13	18,0 0.709	33,0 1.299	83,0 3.268	50,0 1.969	45,0 1.772	16,0 0.630	3,9 0.154	0,13 0.290	A	
A760E20	02594964	Węglak	FB 76002/12	13,0 0.512	20,0 0.787	82,5 3.248	60,0 2.362	54,0 2.126	12,0 0.472	1,4 0.055	0,2 0.440	A	
A760E30	02594965	Węglak	FB 76003/13	13,0 0.512	18,0 0.709	103,0 4.055	70,0 2.756	65,0 2.559	16,0 0.630	1,4 0.055	0,21 0.460	A	
A760E31	02594966	Węglak	FB 76003/13	18,0 0.709	33,0 1.299	113,0 4.449	80,0 3.150	75,0 2.953	16,0 0.630	3,9 0.154	0,3 0.660	A	
A760A32	02594977	Aluminium	FB 76003/13	33,0 1.299	48,0 1.890	88,0 3.465	60,0 2.362	50,0 1.969	16,0 0.630	11,5 0.453	0,14 0.310	B	***
A760A33	02594978	Aluminium	FB 76003/13	48,0 1.890	63,0 2.480	108,0 4.252	80,0 3.150	70,0 2.756	16,0 0.630	19,0 0.748	0,34 0.750	B	***

Części zamienne, zawarte w dostawie

Do głowicy	Śruba mocująca
A76002/12	C04008-T15P
A76003/13	C04008-T15P
A76003	C04008-T15P

Akcesoria

Klucz (Typu T)
DOUBLE-T
DOUBLE-T
DOUBLE-T

**+0,2 mm dodatkowy zakres.

*** W przypadku użycia na A760 13, dokładne wyważenie nie jest możliwe. Wybierz odpowiednią kombinację oprawki i wkładki, korzystając z tabeli wyboru na stronie(stronach) 597.

Uwaga: Waga podana bez wkładki.

Akcesoria, należy zamawiać osobno

Wkładki do modułowych wytaczadeł na gotowo

Do głowic FB 760

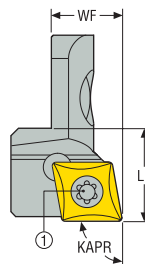

1 = Śruba mocująca płytkę

- Wielkość pojedynczego mocowania odpowiedni dla wszystkich wytaczaków (i do obtaczania)
- Jedna wielkość płytki dla wszystkich wkładek

Oznaczenie	Numer produktu	LF	WF*	Waga	Odpowiednia wielkość płytki	KRINS°
		mm Cal.	mm Cal.	kg lbs		
A765R1	02594979	10,0 0.394	4,95 0.195	0,1 0.220	CC..0602..	90
A765R2	02594983	10,0 0.394	6,2 0.244	0,1 0.220	CC..0602..	90
A765R3	02594984	10,0 0.394	7,45 0.293	0,01 0.020	CC..0602..	90
A765R4	02594987	10,0 0.394	8,7 0.343	0,01 0.020	CC..0602..	90
A765R5	02594989	10,0 0.394	9,97 0.393	0,01 0.020	CC..0602..	90
A765R6	02594990	10,0 0.394	11,2 0.441	0,1 0.220	CC..0602..	90

Części zamienne, zawarte w dostawie

Dla płytki o wielkości	Śruba do płytki
CC...0602...	C02504-T07P



Aksesoria

Klucz do płytki	Klucz (Typu T)
H4B-T07P	DOUBLE-T



*WF w przypadku wyposażenia w płytkę typu CC..060204.

Wybierz odpowiednią kombinację oprawki i wkładki, korzystając z tabeli wyboru na stronie(stronach) 597.

Aksesoria, należy zamawiać osobno

Wstęp

Wiercenie

Rozwiercanie

Wytaczanie

Załącznik

Tabela wyboru: Narzędzia do wytaczania i wkładki do płytek odpowiednie dla głowic FB 760

Do głowicy	Zakres wytaczania DCN-DCX		Długość wytaczania LB		Oznaczenie		DMM		Odpowiednia wielkość płytki	Typ narzędzia
	∅ mm	cal.	mm	cal.	Narzędzie do wytaczania	Wkładki na płytki	mm	cal.		
A760 01	0,3-0,6	0.012-0.024	1,2	0.047	A761402	-	4	0.157	-	Węglik spiekany
	0,5-1,1	0.020-0.043	2	0.078	A761412	-	4	0.157	-	Węglik spiekany
	1-2,1	0.039-0.083	-	-	A761422	-	4	0.157	-	Węglik spiekany
	2-3,2	0.079-0.126	8	0.315	A761432	-	4	0.157	-	Węglik spiekany
	3-4,7	0.118-0.185	10	0.394	A761442	-	4	0.157	-	Węglik spiekany
	4,5-6,2	0.177-0.244	15	0.591	A761452	-	4	0.157	-	Węglik spiekany
	6-8	0.236-0.315	16	0.630	A762001	-	6	0.236	WB..0301..	Stal, typ płytki
	6-8	0.236-0.315	26	1.024	A762201	-	6	0.236	WB..0301..	Płytki węglkowe
A760 02/ A760 12	2-3,2	0.079-0.126	8	0.315	A761432	-	4	0.157	-	Węglik spiekany
	3-4,7	0.118-0.185	10	0.394	A761442	-	4	0.157	-	Węglik spiekany
	4,5-6,2	0.177-0.244	15	0.591	A761452	-	4	0.157	-	Węglik spiekany
	6-8	0.236-0.315	16	0.630	A762002	-	12	0.472	WB..0301..	Stal, typ płytki
	6-8	0.236-0.315	27	1.063	A762202	-	12	0.472	WB..0301..	Płytki węglkowe
	8-10	0.315-0.394	22	0.866	A763002	-	12	0.472	WB..0301..	Stal, typ płytki
	8-10	0.315-0.394	37	1.457	A763202	-	12	0.472	WB..0301..	Płytki węglkowe
	10-13	0.394-0.512	30	1.181	A765002	-	12	0.472	CC..0602..	Stal, typ płytki
	10-13	0.394-0.512	55	2.165	A765202	-	12	0.472	CC..0602..	Płytki węglkowe
	13-15,5	0.512-0.610	40	1.575	A760S20	A765R1	12	0.472	CC..0602..	Oprawka węglkowa z wkładką na płytkę
	13-15,5	0.512-0.610	60	2.362	A760E20	A765R1	12	0.472	CC..0602..	Oprawki węglkowe z wkładkami na płytkę
	15,5-18	0.610-0.709	40	1.575	A760S20	A765R2	12	0.472	CC..0602..	Oprawka węglkowa z wkładką na płytkę
	15,5-18	0.610-0.709	60	2.362	A760E20	A765R2	12	0.472	CC..0602..	Oprawki węglkowe z wkładkami na płytkę
	18-20	0.709-0.787	40	1.575	A760S20	A765R3	12	0.472	CC..0602..	Oprawka węglkowa z wkładką na płytkę
	18-20	0.709-0.787	60	2.362	A760E20	A765R3	12	0.472	CC..0602..	Oprawki węglkowe z wkładkami na płytkę
	A760 03/ A760 13	6-8	0.236-0.315	16	0.630	A762003	-	16	0.630	WB..0301..
6-8		0.236-0.315	32	1.260	A762203	-	16	0.630	WB..0301..	Płytki węglkowe
8-10		0.315-0.394	22	0.866	A763003	-	16	0.630	WB..0301..	Stal, typ płytki
8-10		0.315-0.394	37	1.457	A763203	-	16	0.630	WB..0301..	Płytki węglkowe
10-13		0.394-0.512	30	1.181	A765003	-	16	0.630	CC..0602..	Stal, typ płytki
10-13		0.394-0.512	55	2.165	A765203	-	16	0.630	CC..0602..	Płytki węglkowe
13-15,5		0.512-0.610	40	1.575	A760S30	A765R1	16	0.630	CC..0602..	Oprawka węglkowa z wkładką na płytkę
13-15,5		0.512-0.610	70	2.756	A760E30	A765R1	16	0.630	CC..0602..	Oprawki węglkowe z wkładkami na płytkę
15,5-18		0.610-0.709	40	1.575	A760S30	A765R2	16	0.630	CC..0602..	Oprawka węglkowa z wkładką na płytkę
15,5-18		0.610-0.709	70	2.756	A760E30	A765R2	16	0.630	CC..0602..	Oprawki węglkowe z wkładkami na płytkę
18-20,5		0.709-0.807	50	1.969	A760S31	A765R1	16	0.630	CC..0602..	Oprawka węglkowa z wkładką na płytkę
18-20,5		0.709-0.807	80	3.150	A760E31	A765R1	16	0.630	CC..0602..	Oprawki węglkowe z wkładkami na płytkę
20,5-23		0.807-0.906	50	1.969	A760S31	A765R2	16	0.630	CC..0602..	Oprawka węglkowa z wkładką na płytkę
20,5-23		0.807-0.906	80	3.150	A760E31	A765R2	16	0.630	CC..0602..	Oprawki węglkowe z wkładkami na płytkę
23-25,5		0.906-1.00	50	1.969	A760S31	A765R3	16	0.630	CC..0602..	Oprawka węglkowa z wkładką na płytkę
23-25,5		0.906-1.00	80	3.150	A760E31	A765R3	16	0.630	CC..0602..	Oprawki węglkowe z wkładkami na płytkę
25,5-28		1.004-1.102	50	1.969	A760S31	A765R4	16	0.630	CC..0602..	Oprawka węglkowa z wkładką na płytkę
25,5-28		1.004-1.102	80	3.150	A760E31	A765R4	16	0.630	CC..0602..	Oprawki węglkowe z wkładkami na płytkę
28-30,5		1.102-1.201	50	1.969	A760S31	A765R5	16	0.630	CC..0602..	Oprawka węglkowa z wkładką na płytkę
28-30,5		1.102-1.201	80	3.150	A760E31	A765R5	16	0.630	CC..0602..	Oprawki węglkowe z wkładkami na płytkę
30,5-33		1.201-1.299	50	1.969	A760S31	A765R6	16	0.630	CC..0602..	Oprawka węglkowa z wkładką na płytkę
30,5-33		1.201-1.299	80	3.150	A760E31	A765R6	16	0.630	CC..0602..	Oprawki węglkowe z wkładkami na płytkę
33-35,5*		1.299-1.398*	60	2.362	A760A32	A765R1	16	0.630	CC..0602..	Oprawki aluminiowe z wkładkami na płytkę
35,5-38*		1.299-1.496*	60	2.362	A760A32	A765R2	16	0.630	CC..0602..	Oprawki aluminiowe z wkładkami na płytkę
38-40,5*		1.496-1.594*	60	2.362	A760A32	A765R3	16	0.630	CC..0602..	Oprawki aluminiowe z wkładkami na płytkę
40,5-43*		1.594-1.693*	60	2.362	A760A32	A765R4	16	0.630	CC..0602..	Oprawki aluminiowe z wkładkami na płytkę
43-45,5*		1.693-1.791*	60	2.362	A760A32	A765R5	16	0.630	CC..0602..	Oprawki aluminiowe z wkładkami na płytkę
45,5-48*		1.791-1.890*	60	2.362	A760A32	A765R6	16	0.630	CC..0602..	Oprawki aluminiowe z wkładkami na płytkę
48-50,5*		1.890-1.988*	80	3.150	A760A33	A765R1	16	0.630	CC..0602..	Oprawki aluminiowe z wkładkami na płytkę
50,5-53*		1.988-2.087*	80	3.150	A760A33	A765R2	16	0.630	CC..0602..	Oprawki aluminiowe z wkładkami na płytkę
53-55,5*		2.087-2.185*	80	3.150	A760A33	A765R3	16	0.630	CC..0602..	Oprawki aluminiowe z wkładkami na płytkę
55,5-58*		2.185-2.283*	80	3.150	A760A33	A765R4	16	0.630	CC..0602..	Oprawki aluminiowe z wkładkami na płytkę
58-60,5*	2.283-2.382*	80	3.150	A760A33	A765R5	16	0.630	CC..0602..	Oprawki aluminiowe z wkładkami na płytkę	
60,5-63*	2.382-2.480*	80	3.150	A760A33	A765R6	16	0.630	CC..0602..	Oprawki aluminiowe z wkładkami na płytkę	

W przypadku dużych średnic, patrz rozdział adapter uniwersalny (MPA).
* W przypadku użycia na A760 13, dokładne wyważenie nie jest możliwe.

Adapter wielofunkcyjny (MPA)

Do głowic FB 760

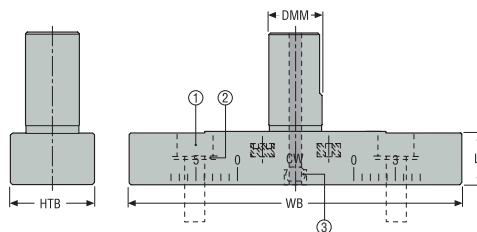

- Nadaje się do - Axiabore™ Plus - tylko głowice A760 03*
- Przeznaczone do mocowania oprawki i przeciwwagi (do wytaczania lub obtaczania) lub dwóch oprawek do rowków (do toczenia rowków czołowych)
- Chłodziwo przez regulowaną dyszę (3)

1. Śruba montażowa
2. Podkładka
3. Regulowana dysza

Numer produktu	Oznaczenie	Zakres DCN-DCX Ø						HTB	LF	DMM	WB	Waga
		Do wytaczania		Do obtaczania średnicy zewnętrznej		Do rowkowania						
		mm	mm	mm	mm	mm	mm	mm	mm	mm	mm	kg
		Cal.	Cal.	Cal.	Cal.	Cal.	Cal.	Cal.	Cal.	Cal.	Cal.	lbs
02595014	BDA16BS25100	53,0	108,0	2,0	57,0	31,0	96,0	25,0	16,0	16,0	100,0	0,28
		2.087	4.252	0.079	2.244	1.220	3.780	0.984	0.630	0.630	3.937	0.620

Części zamienne, zawarte w dostawie

Dla	Śruba mocująca	Podkładka
BDA16BS25100	950D0618	940ZC06

* W przypadku stosowania z głowicą - Axialbore™ Plus - A760 13, brak możliwości dokładnego wyważania, patrz strona(y) 589
Wybierz wymagane komponenty do realizacji zespołów wytaczania, obtaczania lub toczenia rowków, używając następujących stron 602-613

Akcesoria

Do głowicy	Klucz mocujący
BDA16BS25100	03HL05

Akcesoria, należy zamawiać osobno

Oprawka i przeciwwaga do wytaczania lub obtaczania z MPA

Do głowic FB 760

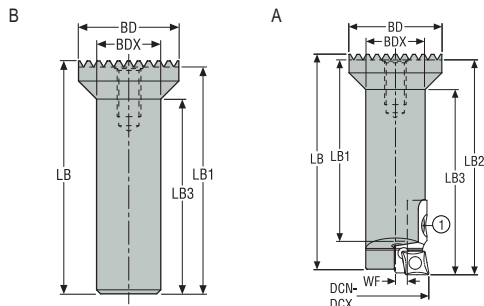

1. Śruba montażowa



- Do montażu na MPA
- Oprawka może być używany do wytaczania lub obtaczania
- Przyjmuje te same wkładki co wytaczarki modułowe

Numer produktu	Oznaczenie	Konstrukcja	** Zakres DCN-DCX \varnothing				LB	LB1	LB2	LB3	WF	BDX	BD	Waga	Wersja
			Do wytaczania		Do obtaczania średnicy zewnętrznej										
			mm Cal.	mm Cal.	mm Cal.	mm Cal.									
02595019	BAS25MH1660	Chwył*	53,0 2.087	108,0 4.252	2,0 0.079	57,0 2.244	58,5 2.303	48,5 1.909	58,5 2.303	50,0 1.969	4,0 0.157	16,0 0.630	25,0 0.984	0,1 0.220	A
02595016	BAS25CW1660	Przeciwwaga	53,0 2.087	108,0 4.252	2,0 0.079	57,0 2.244	58,0 2.283	56,6 2.228	-	48,5 1.909	-	16,0 0.630	25,0 0.984	0,2 0.440	B

Części zamienne, zawarte w dostawie

Dla	Śruba mocująca
BAS25MH1660	C04008-T15P
BAS25CW1660	-

Akcesoria

Dla	Klucz (Typu T)
BAS25MH1660	DOUBLE-T
BAS25CW1660	-

*Wkładki należy zamawiać oddzielnie, patrz str. 596

** Zakresy wytaczania i obtaczania odnoszą się do wybranej oprawki i pozycji ustawienia przy użyciu „tabeli oprawek do wytaczania lub obtaczania” na stronach 602-613

Akcesoria, należy zamawiać osobno

Oprawki do toczenia rowków, do toczenia rowków czołowych w MPA

Do głowic FB 760

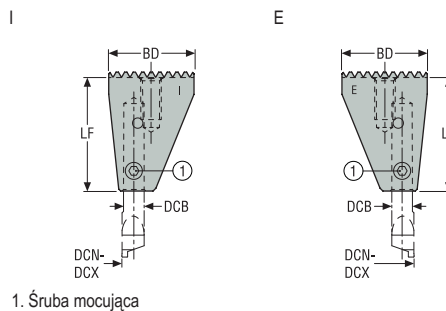

- Do montażu na MPA
- Oprawka do rowków służy albo do trzymania narzędzia do rowkowania, albo jako przeciwwaga

Numer produktu	Oznaczenie	Konstrukcja	* Zakres DCN-DCX Ø		DCB	LF	BD	Waga	Wersja
			mm	mm					
02595021	BAS25FGI35	Oprawka wytaczarska I (wewnętrzna)*	19,0 0.748	76,0 2.992	6,0 0.236	35,0 1.378	25,0 0.984	0,1 0.220	I (Wewnętrzna)
02595020	BAS25FGE35	Oprawka wytaczarska E (zewnętrzna)*	39,0 1.535	96,0 3.780	6,0 0.236	35,0 1.378	25,0 0.984	0,1 0.220	E (Zewnętrzna)

Części zamienne, zawarte w dostawie

Akcesoria

Dla	Śruba mocująca	Klucz (Typu T)
BAS25FGI35	950L0607T15P	DOUBLE-T
BAS25FGE35	950L0607T15P	DOUBLE-T

*Oprawki należy zamawiać oddzielnie, patrz str. 601

* Wydajność toczenia rowków jest związana z wybranym narzędziem do toczenia rowków, położeniem i orientacją oprawki do rowków, za pomocą "narzędzia do toczenia kanałków wokół czopu (lub w otworze)" patrz strona(y) 602-613

Akcesoria, należy zamawiać osobno

Narzędzia do rowków

Do głowic FB 760

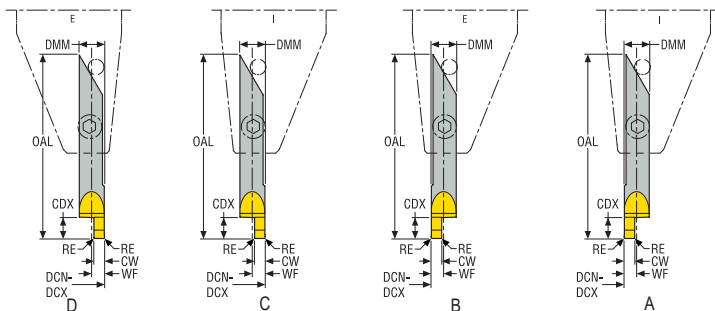

- Może być stosowany do opravek do toczenia rowków „zewnątrznych” lub „wewnętrznych”, w zależności od zakresu

* Zakres DCN-DCX ∅																					
Numer produktu	Oznaczenie	Konstrukcja	Wersja A				Wersja B				Wersja C				OAL	CW	RE	DMM	WF	Maks. głęb. **	Waga
			mm Cal.	mm Cal.	mm Cal.	mm Cal.	mm Cal.	mm Cal.	mm Cal.	mm Cal.	mm Cal.	mm Cal.	mm Cal.	mm Cal.							
02595028	AFG0629101582	Przy czopie	19,0 0.748	64,0 2.520	39,0 1.535	84,0 3.307	-	-	-	-	42,0 1.654	1,0 0.039	0,15 0.006	6,0 0.236	2,95 0.116	2,0 0.079	0,07 0.150				
02595029	AFG0629151582	Przy czopie	19,0 0.748	64,0 2.520	39,0 1.535	84,0 3.307	-	-	-	-	42,0 1.654	1,5 0.059	0,15 0.006	6,0 0.236	2,95 0.116	3,0 0.118	0,07 0.150				
02595031	AFG0629201582	Przy czopie	19,0 0.748	64,0 2.520	39,0 1.535	84,0 3.307	-	-	-	-	42,0 1.654	2,0 0.079	0,15 0.006	6,0 0.236	2,95 0.116	5,0 0.197	0,07 0.150				
02595032	AFG0629251582	Przy czopie	19,0 0.748	64,0 2.520	39,0 1.535	84,0 3.307	-	-	-	-	42,0 1.654	2,5 0.098	0,15 0.006	6,0 0.236	2,95 0.116	5,0 0.197	0,07 0.150				
02595033	AFG0629301582	Przy czopie	19,0 0.748	64,0 2.520	39,0 1.535	84,0 3.307	-	-	-	-	42,0 1.654	3,0 0.118	0,15 0.006	6,0 0.236	2,95 0.116	6,0 0.236	0,07 0.150				
02595022	AFG0629101581	Przy otworze	-	-	-	-	31,0 1.220	76,0 2.992	51,0 2.008	96,0 3.780	42,0 1.654	1,0 0.039	0,15 0.006	6,0 0.236	2,95 0.116	2,0 0.079	0,02 0.040				
02595023	AFG0629151581	Przy otworze	-	-	-	-	31,0 1.220	76,0 2.992	51,0 2.008	96,0 3.780	42,0 1.654	1,5 0.059	0,15 0.006	6,0 0.236	2,95 0.116	3,0 0.118	0,07 0.150				
02595024	AFG0629201581	Przy otworze	-	-	-	-	31,0 1.220	76,0 2.992	51,0 2.008	96,0 3.780	42,0 1.654	2,0 0.079	0,15 0.006	6,0 0.236	2,95 0.116	4,0 0.157	0,07 0.150				
02595026	AFG0629251581	Przy otworze	-	-	-	-	31,0 1.220	76,0 2.992	51,0 2.008	96,0 3.780	42,0 1.654	2,5 0.098	0,15 0.006	6,0 0.236	2,95 0.116	5,0 0.197	0,07 0.150				
02595027	AFG0629301581	Przy otworze	-	-	-	-	31,0 1.220	76,0 2.992	51,0 2.008	96,0 3.780	42,0 1.654	3,0 0.118	0,15 0.006	6,0 0.236	2,95 0.116	6,0 0.236	0,07 0.150				

* Wydajność toczenia rowków jest związana z wybranym narzędziem do toczenia rowków, położeniem i orientacją oprawki do rowków, za pomocą „narzędzia do toczenia kanałków wokół czopu (lub w otworze)” patrz strona(y) 602-613

** Maks. głębokość rowka CDX

Części zamienne, zawarte w dostawie

Narzędzie do toczenia rowków -przy czopie-

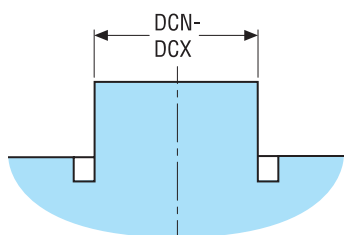

Narzędzie do toczenia rowków -przy otworze-

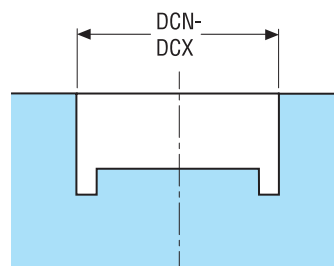

Metryczne Tabela wyboru:

Narzędzia do wytaczania i wkładki do płytek odpowiednie dla głowic FB 760

	Zakres DCN-DCX Ø mm*	Oznaczenie wkładki	Polożenie oprawki	Wymiary w mm					Kąt przyłożenia KRINS°	Odpowiednia wielkość płytki
				BD	BD1	LF	LB	WB		
	53-55,5	A765 R1	0	16	25	58,5	50	17	90°	CC..0602..
	55,5-58	A765 R2	0	16	25	58,5	50	18,2	90°	CC..0602..
	58-60,5	A765 R1	1	16	25	58,5	50	17	90°	CC..0602..
		A765 R3	0	16	25	58,5	50	19,5	90°	CC..0602..
	60,5-63	A765 R2	1	16	25	58,5	50	18,2	90°	CC..0602..
		A765 R4	0	16	25	58,5	50	20,7	90°	CC..0602..
	63-65,5	A765 R1	2	16	25	58,5	50	17	90°	CC..0602..
		A765 R3	1	16	25	58,5	50	19,5	90°	CC..0602..
	65,5-68	A765 R5	0	16	25	58,5	50	22	90°	CC..0602..
		A765 R2	2	16	25	58,5	50	18,2	90°	CC..0602..
	68-70,5	A765 R4	1	16	25	58,5	50	20,7	90°	CC..0602..
		A765 R6	0	16	25	58,5	50	23,3	90°	CC..0602..
	70,5-73	A765 R1	3	16	25	58,5	50	17	90°	CC..0602..
		A765 R3	2	16	25	58,5	50	19,5	90°	CC..0602..
	73-75,5	A765 R5	1	16	25	58,5	50	22	90°	CC..0602..
		A765 R2	3	16	25	58,5	50	18,2	90°	CC..0602..
	75,5-78	A765 R4	2	16	25	58,5	50	20,7	90°	CC..0602..
		A765 R6	1	16	25	58,5	50	23,2	90°	CC..0602..
	78-80,5	A765 R1	4	16	25	58,5	50	17	90°	CC..0602..
		A765 R3	3	16	25	58,5	50	19,5	90°	CC..0602..
	80,5-83	A765 R5	2	16	25	58,5	50	22	90°	CC..0602..
		A765 R2	4	16	25	58,5	50	18,2	90°	CC..0602..
	83-85,5	A765 R4	3	16	25	58,5	50	20,7	90°	CC..0602..
		A765 R6	2	16	25	58,5	50	23,2	90°	CC..0602..
	85,5-88	A765 R1	5	16	25	58,5	50	17	90°	CC..0602..
		A765 R3	4	16	25	58,5	50	19,5	90°	CC..0602..
	88-90,5	A765 R5	3	16	25	58,5	50	22	90°	CC..0602..
		A765 R2	5	16	25	58,5	50	18,2	90°	CC..0602..
	90,5-93	A765 R4	4	16	25	58,5	50	20,7	90°	CC..0602..
		A765 R6	3	16	25	58,5	50	23,2	90°	CC..0602..
	93-95,5	A765 R1	6	16	25	58,5	50	17	90°	CC..0602..
		A765 R3	5	16	25	58,5	50	19,5	90°	CC..0602..
	95,5-98	A765 R5	4	16	25	58,5	50	22	90°	CC..0602..
		A765 R2	6	16	25	58,5	50	18,2	90°	CC..0602..
	98-100,5	A765 R4	5	16	25	58,5	50	20,7	90°	CC..0602..
		A765 R6	4	16	25	58,5	50	23,2	90°	CC..0602..
	100,5-103	A765 R1	7	16	25	58,5	50	17	90°	CC..0602..
		A765 R3	6	16	25	58,5	50	19,5	90°	CC..0602..
	103-105,5	A765 R5	5	16	25	58,5	50	22	90°	CC..0602..
		A765 R2	7	16	25	58,5	50	18,2	90°	CC..0602..
	105,5-108	A765 R4	6	16	25	58,5	50	20,7	90°	CC..0602..
		A765 R6	5	16	25	58,5	50	23,2	90°	CC..0602..

Wybrać odpowiednią wkładkę i zanotować pozycję wytaczaka na adapterze MPA, w celu uzyskania wymaganego zakresu wytaczania.
 Uwaga: Zestaw do obróbki rowków wokół czopu powinien zawierać:
 - głowicę Axiabore™ Plus - (A760 03)
 - adapter wielofunkcyjny MPA (BD-A16BS25100)
 - wytaczak (BAS25MH1660)
 - przeciwcieżar (BAS25CW1660).
 - wkładkę (A765R.), którą należy wybrać z tabeli
 - płytkę

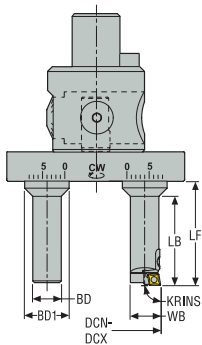

* +0,2 mm (0.008") dostępny dodatkowy zakres.
 Szczegółowe opisy oprawek patrz str. 596

Wstęp

Wiercenie

Rozwiercanie

Wytaczanie

Załącznik

Calowe Tabela wyboru:
Narzędzia do wytaczania i wkładki do płytek odpowiednie dla głowic FB 760

	Zakres DCN-DCX Ø cal.*	Oznaczenie wkładki	Polożenie oprawki	Wymiary w calach					Kąt przyłożenia KRINS°	Odpowiednia wielkość płytki
				BD	BD1	LF	LB	WB		
<p>Wybrać odpowiednią wkładkę i zanotować pozycję wytaczacza na adapterze MPA, w celu uzyskania wymaganego zakresu wytaczania.</p> <p>Uwaga: Zestaw do obróbki rowków wokół czopu powinien zawierać:</p> <ul style="list-style-type: none"> - głowicę Axiabore™ Plus - (A760 03) - adapter wielofunkcyjny MPA (BD-A16BS25100) - wytaczak (BAS25MH1660) - przeciwcieżar (BAS25CW1660). - wkładkę (A765R.), którą należy wybrać z tabeli - płytkę 	2.087-2.185	A765 R1	0	0.630	0.984	2.303	1.969	0.669	90°	CC..0602..
	2.185-2.283	A765 R2	0	0.630	0.984	2.303	1.969	0.717	90°	CC..0602..
	2.283-2.382	A765 R1	1	0.630	0.984	2.303	1.969	0.669	90°	CC..0602..
		A765 R3	0	0.630	0.984	2.303	1.969	0.768	90°	CC..0602..
	2.382-2.480	A765 R2	1	0.630	0.984	2.303	1.969	0.717	90°	CC..0602..
		A765 R4	0	0.630	0.984	2.303	1.969	0.815	90°	CC..0602..
	2.480-2.579	A765 R1	2	0.630	0.984	2.303	1.969	0.669	90°	CC..0602..
		A765 R3	1	0.630	0.984	2.303	1.969	0.768	90°	CC..0602..
	2.579-2.677	A765 R5	0	0.630	0.984	2.303	1.969	0.866	90°	CC..0602..
		A765 R2	2	0.630	0.984	2.303	1.969	0.717	90°	CC..0602..
	2.677-2.776	A765 R4	1	0.630	0.984	2.303	1.969	0.815	90°	CC..0602..
		A765 R6	0	0.630	0.984	2.303	1.969	0.917	90°	CC..0602..
	2.776-2.874	A765 R1	3	0.630	0.984	2.303	1.969	0.669	90°	CC..0602..
		A765 R3	2	0.630	0.984	2.303	1.969	0.768	90°	CC..0602..
	2.874-2.972	A765 R5	1	0.630	0.984	2.303	1.969	0.866	90°	CC..0602..
		A765 R2	3	0.630	0.984	2.303	1.969	0.717	90°	CC..0602..
	2.972-3.071	A765 R4	2	0.630	0.984	2.303	1.969	0.815	90°	CC..0602..
		A765 R6	1	0.630	0.984	2.303	1.969	0.913	90°	CC..0602..
	3.071-3.169	A765 R1	4	0.630	0.984	2.303	1.969	0.669	90°	CC..0602..
		A765 R3	3	0.630	0.984	2.303	1.969	0.768	90°	CC..0602..
	3.169-3.268	A765 R5	2	0.630	0.984	2.303	1.969	0.866	90°	CC..0602..
		A765 R2	4	0.630	0.984	2.303	1.969	0.717	90°	CC..0602..
	3.268-3.366	A765 R4	3	0.630	0.984	2.303	1.969	0.815	90°	CC..0602..
		A765 R6	2	0.630	0.984	2.303	1.969	0.913	90°	CC..0602..
	3.366-3.465	A765 R1	5	0.630	0.984	2.303	1.969	0.669	90°	CC..0602..
		A765 R3	4	0.630	0.984	2.303	1.969	0.768	90°	CC..0602..
	3.465-3.563	A765 R5	3	0.630	0.984	2.303	1.969	0.866	90°	CC..0602..
		A765 R2	5	0.630	0.984	2.303	1.969	0.717	90°	CC..0602..
	3.563-3.661	A765 R4	4	0.630	0.984	2.303	1.969	0.815	90°	CC..0602..
		A765 R6	3	0.630	0.984	2.303	1.969	0.913	90°	CC..0602..
	3.661-3.760	A765 R1	6	0.630	0.984	2.303	1.969	0.669	90°	CC..0602..
		A765 R3	5	0.630	0.984	2.303	1.969	0.768	90°	CC..0602..
	3.760-3.858	A765 R5	4	0.630	0.984	2.303	1.969	0.866	90°	CC..0602..
		A765 R2	6	0.630	0.984	2.303	1.969	0.717	90°	CC..0602..
	3.858-3.957	A765 R4	7	0.630	0.984	2.303	1.969	0.815	90°	CC..0602..
		A765 R6	6	0.630	0.984	2.303	1.969	0.913	90°	CC..0602..
	3.957-4.055	A765 R1	8	0.630	0.984	2.303	1.969	0.669	90°	CC..0602..
		A765 R3	7	0.630	0.984	2.303	1.969	0.768	90°	CC..0602..
	4.055-4.154	A765 R5	6	0.630	0.984	2.303	1.969	0.866	90°	CC..0602..
		A765 R2	8	0.630	0.984	2.303	1.969	0.717	90°	CC..0602..
4.154-4.252	A765 R4	7	0.630	0.984	2.303	1.969	0.815	90°	CC..0602..	
		A765 R6	8	0.630	0.984	2.303	1.969	0.913	90°	CC..0602..

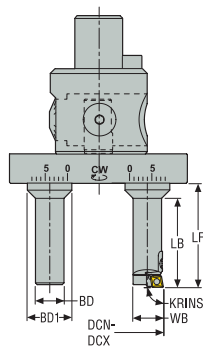

* +0.2 mm (0.008") dostępny dodatkowy zakres.
Szczegółowe opisy oprawek patrz str. 596

Wstęp

Wfrczenie

Rozwiercanie

Wytaczanie

Załącznik

Metryczne Tabela wyboru: Wkładki do obtaczania z MPA dla głowic FB 760

	Zakres DCN-DCX Ø mm*	Oznaczenie wkładki	Polożenie oprawki	Wymiary w mm					Kąt przyłożenia KRINS°	Odpowiednia wielkość płytki
				BD	BD1	LF	LB	WB		
	2-4,5	A765 R6	0	16	25	58,5	50	23,2	90°	CC..0602..
	4,5-7	A765 R5	0	16	25	58,5	50	22	90°	CC..0602..
	7-9,5	A765 R6	1	16	25	58,5	50	23,2	90°	CC..0602..
		A765 R4	0	16	25	58,5	50	20,7	90°	CC..0602..
	9,5-12	A765 R5	1	16	25	58,5	50	22	90°	CC..0602..
		A765 R3	0	16	25	58,5	50	19,5	90°	CC..0602..
	12-14,5	A765 R6	2	16	25	58,5	50	23,2	90°	CC..0602..
		A765 R4	1	16	25	58,5	50	20,7	90°	CC..0602..
	14,5-17	A765 R2	0	16	25	58,5	50	18,2	90°	CC..0602..
		A765 R5	2	16	25	58,5	50	22	90°	CC..0602..
	17-19,5	A765 R3	1	16	25	58,5	50	19,5	90°	CC..0602..
		A765 R1	0	16	25	58,5	50	17	90°	CC..0602..
	19,5-22	A765 R6	3	16	25	58,5	50	23,2	90°	CC..0602..
		A765 R4	2	16	25	58,5	50	20,7	90°	CC..0602..
	22-24,5	A765 R2	1	16	25	58,5	50	18,2	90°	CC..0602..
		A765 R5	3	16	25	58,5	50	22	90°	CC..0602..
	24,5-27	A765 R3	2	16	25	58,5	50	19,5	90°	CC..0602..
		A765 R1	1	16	25	58,5	50	17	90°	CC..0602..
	27-29,5	A765 R6	4	16	25	58,5	50	23,2	90°	CC..0602..
		A765 R4	3	16	25	58,5	50	20,7	90°	CC..0602..
	29,5-32	A765 R2	2	16	25	58,5	50	18,2	90°	CC..0602..
		A765 R5	4	16	25	58,5	50	22	90°	CC..0602..
	32-34,5	A765 R3	3	16	25	58,5	50	19,5	90°	CC..0602..
		A765 R1	2	16	25	58,5	50	17	90°	CC..0602..
	34,5-37	A765 R6	5	16	25	58,5	50	23,2	90°	CC..0602..
		A765 R4	4	16	25	58,5	50	20,7	90°	CC..0602..
	37-39,5	A765 R2	3	16	25	58,5	50	18,2	90°	CC..0602..
		A765 R5	5	16	25	58,5	50	22	90°	CC..0602..
	39,5-42	A765 R3	4	16	25	58,5	50	19,5	90°	CC..0602..
		A765 R1	3	16	25	58,5	50	17	90°	CC..0602..
	42-44,5	A765 R6	6	16	25	58,5	50	23,2	90°	CC..0602..
		A765 R4	5	16	25	58,5	50	20,7	90°	CC..0602..
	44,5-47	A765 R2	4	16	25	58,5	50	18,2	90°	CC..0602..
		A765 R5	6	16	25	58,5	50	22	90°	CC..0602..
	47-49,5	A765 R3	7	16	25	58,5	50	19,5	90°	CC..0602..
		A765 R1	6	16	25	58,5	50	17	90°	CC..0602..
	49,5-52	A765 R4	8	16	25	58,5	50	20,7	90°	CC..0602..
		A765 R2	7	16	25	58,5	50	18,2	90°	CC..0602..
	52-54,5	A765 R3	8	16	25	58,5	50	19,5	90°	CC..0602..
		A765 R1	7	16	25	58,5	50	17	90°	CC..0602..
	54,5-57	A765 R2	8	16	25	58,5	50	18,2	90°	CC..0602..
		A765 R1	8	16	25	58,5	50	17	90°	CC..0602..

Wybrać odpowiednie narzędzie do wpuśców i zanotować położenie uchwytu narzędzia do wpuśców w MPA, aby uzyskać wymagany zakres wytaczania.
 Uwaga: Zespół do wytaczania wymaga:
 - Axiabore™ Plus - Głowica (A760 03)
 - Adapter MPA (BDA16BS25100)
 - Oprawka (BAS25MH1660)
 - Przeciwwaga (BAS25CW1660).
 - Wkładka (A765R..) do wyboru na wykresie
 - Płytki

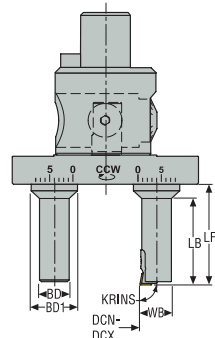

* +0,2 mm (0.008") dostępny dodatkowy zakres.
 Szczegółowe opisy oprawek patrz str. 596

Wstęp

Wiercenie

Rozwiercanie

Wytaczanie

Załącznik

Calowe Tabela wyboru:
Wkładki do obtaczania z MPA dla głowic FB 760

	Zakres DCN-DCX Ø cal.*	Oznaczenie wkładki	Położenie oprawki	Wymiary w calach					Kąt przyłożenia KRINS°	Odpowiednia wielkość płytki
				BD	BD1	LF	LB	WB		
	0.079-0.177	A765 R6	0	0.630	0.984	2.303	1.969	0.913	90°	CC..0602..
	0.177-0.276	A765 R5	0	0.630	0.984	2.303	1.969	0.866	90°	CC..0602..
	0.276-0.374	A765 R6	1	0.630	0.984	2.303	1.969	0.913	90°	CC..0602..
		A765 R4	0	0.630	0.984	2.303	1.969	0.815	90°	CC..0602..
	0.374-0.472	A765 R5	1	0.630	0.984	2.303	1.969	0.866	90°	CC..0602..
		A765 R3	0	0.630	0.984	2.303	1.969	0.768	90°	CC..0602..
	0.472-0.571	A765 R6	2	0.630	0.984	2.303	1.969	0.913	90°	CC..0602..
		A765 R4	1	0.630	0.984	2.303	1.969	0.815	90°	CC..0602..
	0.571-0.669	A765 R2	0	0.630	0.984	2.303	1.969	0.717	90°	CC..0602..
		A765 R5	2	0.630	0.984	2.303	1.969	0.866	90°	CC..0602..
		A765 R3	1	0.630	0.984	2.303	1.969	0.768	90°	CC..0602..
	0.669-0.768	A765 R1	0	0.630	0.984	2.303	1.969	0.669	90°	CC..0602..
		A765 R6	3	0.630	0.984	2.303	1.969	0.913	90°	CC..0602..
	0.768-0.866	A765 R4	2	0.630	0.984	2.303	1.969	0.815	90°	CC..0602..
		A765 R2	1	0.630	0.984	2.303	1.969	0.717	90°	CC..0602..
		A765 R5	3	0.630	0.984	2.303	1.969	0.866	90°	CC..0602..
	0.866-0.965	A765 R3	2	0.630	0.984	2.303	1.969	0.768	90°	CC..0602..
		A765 R1	1	0.630	0.984	2.303	1.969	0.669	90°	CC..0602..
		A765 R6	4	0.630	0.984	2.303	1.969	0.913	90°	CC..0602..
	0.965-1.063	A765 R4	3	0.630	0.984	2.303	1.969	0.815	90°	CC..0602..
		A765 R2	2	0.630	0.984	2.303	1.969	0.717	90°	CC..0602..
		A765 R5	4	0.630	0.984	2.303	1.969	0.866	90°	CC..0602..
	1.063-1.161	A765 R3	3	0.630	0.984	2.303	1.969	0.768	90°	CC..0602..
		A765 R1	2	0.630	0.984	2.303	1.969	0.669	90°	CC..0602..
		A765 R6	5	0.630	0.984	2.303	1.969	0.913	90°	CC..0602..
	1.161-1.260	A765 R4	4	0.630	0.984	2.303	1.969	0.815	90°	CC..0602..
		A765 R2	3	0.630	0.984	2.303	1.969	0.717	90°	CC..0602..
		A765 R5	5	0.630	0.984	2.303	1.969	0.866	90°	CC..0602..
	1.260-1.358	A765 R3	4	0.630	0.984	2.303	1.969	0.768	90°	CC..0602..
		A765 R1	3	0.630	0.984	2.303	1.969	0.669	90°	CC..0602..
		A765 R6	6	0.630	0.984	2.303	1.969	0.913	90°	CC..0602..
	1.358-1.457	A765 R4	5	0.630	0.984	2.303	1.969	0.815	90°	CC..0602..
		A765 R2	4	0.630	0.984	2.303	1.969	0.717	90°	CC..0602..
		A765 R5	6	0.630	0.984	2.303	1.969	0.866	90°	CC..0602..
	1.457-1.555	A765 R3	5	0.630	0.984	2.303	1.969	0.768	90°	CC..0602..
		A765 R1	4	0.630	0.984	2.303	1.969	0.669	90°	CC..0602..
		A765 R6	7	0.630	0.984	2.303	1.969	0.913	90°	CC..0602..
	1.555-1.654	A765 R4	6	0.630	0.984	2.303	1.969	0.815	90°	CC..0602..
		A765 R2	5	0.630	0.984	2.303	1.969	0.717	90°	CC..0602..
		A765 R5	7	0.630	0.984	2.303	1.969	0.866	90°	CC..0602..
	1.654-1.654	A765 R3	6	0.630	0.984	2.303	1.969	0.768	90°	CC..0602..
		A765 R1	5	0.630	0.984	2.303	1.969	0.669	90°	CC..0602..
		A765 R6	8	0.630	0.984	2.303	1.969	0.913	90°	CC..0602..
	1.654-1.850	A765 R4	7	0.630	0.984	2.303	1.969	0.815	90°	CC..0602..
		A765 R2	6	0.630	0.984	2.303	1.969	0.717	90°	CC..0602..
		A765 R5	8	0.630	0.984	2.303	1.969	0.866	90°	CC..0602..
	1.850-1.949	A765 R3	7	0.630	0.984	2.303	1.969	0.768	90°	CC..0602..
		A765 R1	6	0.630	0.984	2.303	1.969	0.669	90°	CC..0602..
		A765 R4	8	0.630	0.984	2.303	1.969	0.815	90°	CC..0602..
	1.949-2.047	A765 R2	7	0.630	0.984	2.303	1.969	0.717	90°	CC..0602..
		A765 R3	8	0.630	0.984	2.303	1.969	0.768	90°	CC..0602..
	2.047-2.146	A765 R1	7	0.630	0.984	2.303	1.969	0.669	90°	CC..0602..
	2.146-2.244	A765 R2	8	0.630	0.984	2.303	1.969	0.717	90°	CC..0602..
		A765 R1	8	0.630	0.984	2.303	1.969	0.669	90°	CC..0602..

Wybrać odpowiednie narzędzie do wpustów i zanotować położenie uchwytu narzędzia do wpustów w MPA, aby uzyskać wymagany zakres wytaczania.

Uwaga: Zespół do wytaczania wymaga:

- Axiabore™ Plus - Głowica (A760 03)
- Adapter MPA (BDA16BS25100)
- Oprawka (BAS25MH1660)
- Przeciwwaga (BAS25CW1660).
- Wkładka (A765R.) do wyboru na wykresie
- Płytki

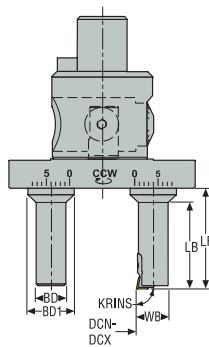

* +0,2 mm (0.008") dostępny dodatkowy zakres.
Szczegółowe opisy oprawek patrz str. 596

Metryczne Tabela wyboru:

Narzędzie do toczenia rowków - wokół czopu - do toczenia rowków z MPA, do głowic FB 760

Wstęp

Wiercenie

Rozwiercanie

Wytaczanie

Załącznik

Obudowa zespołu 1

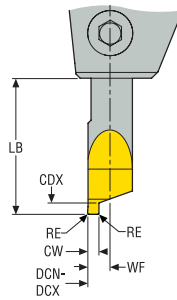
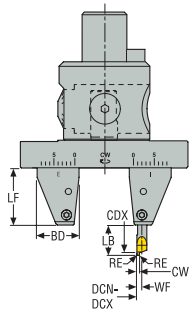

Obudowa zespołu 2

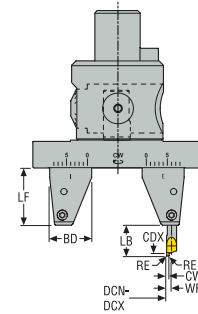

	Zakres DCN-DCX Ø mm*	Oznaczenie narzędzia do kanałów wokół czopu	Pozycja oprawki do rowków**	Konstrukcja	Wymiary w mm						Maks. głęb. kanałka CDX
					BD	CW	LF	LB	WF	RE	
Wybrać odpowiednie narzędzie do wpustów i zanotować położenie uchwytu narzędzia do wpustów w MPA, aby uzyskać wymagany zakres rowkowania.	19-24	AFG0629 10 1582	0-I	1	25	1	34	18	2,95	0,15	2,0
	24-29		1-I	1	25	1	34	18	2,95	0,15	2,0
	29-34		2-I	1	25	1	34	18	2,95	0,15	2,0
	34-39		3-I	1	25	1	34	18	2,95	0,15	2,0
	39-44		0-E / 4-I	1/2	25	1	34	18	2,95	0,15	2,0
	44-49		1-E / 5-I	1/2	25	1	34	18	2,95	0,15	2,0
	49-54		2-E / 6-I	1/2	25	1	34	18	2,95	0,15	2,0
	54-59		3-E / 7-I	1/2	25	1	34	18	2,95	0,15	2,0
	59-64		4-E / 8-I	1/2	25	1	34	18	2,95	0,15	2,0
	64-69		5-E	2	25	1	34	18	2,95	0,15	2,0
69-74	6-E	2	25	1	34	18	2,95	0,15	2,0		
74-79	7-E	2	25	1	34	18	2,95	0,15	2,0		
79-84	8-E	2	25	1	34	18	2,95	0,15	2,0		
Uwaga: Zespół do wytaczania rowków w otworze wymaga:	19-24	AFG0629 15 1582	0-I	1	25	1,5	34	18	2,95	0,15	3,0
• - Axiabore™ Plus - Głowica (A760 03)	24-29		1-I	1	25	1,5	34	18	2,95	0,15	3,0
• Adapter MPA (BDA16BS25100)	29-34		2-I	1	25	1,5	34	18	2,95	0,15	3,0
• Oprawki I (położenie wewnętrzne) i E (położenie zewnętrzne) (BAS25FGI35 i BAS25FGE35) do mocowania narzędzia do rowkowania lub do działania jako przeciwwaga (patrz pozycja ustawienia w tabeli)	34-39		3-I	1	25	1,5	34	18	2,95	0,15	3,0
	39-44		0-E / 4-I	1/2	25	1,5	34	18	2,95	0,15	3,0
	44-49		1-E / 5-I	1/2	25	1,5	34	18	2,95	0,15	3,0
	49-54		2-E / 6-I	1/2	25	1,5	34	18	2,95	0,15	3,0
	54-59		3-E / 7-I	1/2	25	1,5	34	18	2,95	0,15	3,0
	59-64		4-E / 8-I	1/2	25	1,5	34	18	2,95	0,15	3,0
	64-69		5-E	2	25	1,5	34	18	2,95	0,15	3,0
	69-74	6-E	2	25	1,5	34	18	2,95	0,15	3,0	
	74-79	7-E	2	25	1,5	34	18	2,95	0,15	3,0	
	79-84	8-E	2	25	1,5	34	18	2,95	0,15	3,0	
	19-24	AFG0629 20 1582	0-I	1	25	2	34	18	2,95	0,15	4,0
	24-29		1-I	1	25	2	34	18	2,95	0,15	4,0
	29-34		2-I	1	25	2	34	18	2,95	0,15	4,0
	34-39		3-I	1	25	2	34	18	2,95	0,15	4,0
	39-44		0-E / 4-I	1/2	25	2	34	18	2,95	0,15	4,0
	44-49		1-E / 5-I	1/2	25	2	34	18	2,95	0,15	4,0
	49-54		2-E / 6-I	1/2	25	2	34	18	2,95	0,15	4,0
	54-59		3-E / 7-I	1/2	25	2	34	18	2,95	0,15	4,0
	59-64		4-E / 8-I	1/2	25	2	34	18	2,95	0,15	4,0
	64-69		5-E	2	25	2	34	18	2,95	0,15	4,0
	69-74	6-E	2	25	2	34	18	2,95	0,15	4,0	
	74-79	7-E	2	25	2	34	18	2,95	0,15	4,0	
	79-84	8-E	2	25	2	34	18	2,95	0,15	4,0	

* +0,2 mm (0.008") dodatkowy zakres. ** Zalecane wartości oznaczono **pogrubionym** drukiem. Szczegółowy opis narzędzi do toczenia rowków, patrz strona(y) 601

Metryczne Tabela wyboru:
Narzędzie do toczenia rowków - wokół czopu - do toczenia rowków z MPA, do głowic FB 760

	Zakres DCN-DCX Ø mm*	Oznaczenie narzędzia do kanałków wokół czopu	Pozycja oprawki do rowków**	Konstrukcja	Wymiary w mm						Maks. głęb. kanałka CDX
					BD	CW	LF	LB	WF	RE	
Wybrać odpowiednie narzędzie do wpustów i zanotować położenie uchwytu narzędzia do wpustów w MPA, aby uzyskać wymagany zakres rowkowania.	19-24	AFG0629 25 1582	0-I	1	25	2,5	34	18	2,95	0,15	5,0
	24-29		1-I	1	25	2,5	34	18	2,95	0,15	5,0
	29-34		2-I	1	25	2,5	34	18	2,95	0,15	5,0
	34-39		3-I	1	25	2,5	34	18	2,95	0,15	5,0
	39-44		0-E / 4-I	1/2	25	2,5	34	18	2,95	0,15	5,0
	44-49		1-E / 5-I	1/2	25	2,5	34	18	2,95	0,15	5,0
	49-54		2-E / 6-I	1/2	25	2,5	34	18	2,95	0,15	5,0
	54-59		3-E / 7-I	1/2	25	2,5	34	18	2,95	0,15	5,0
	59-64		4-E / 8-I	1/2	25	2,5	34	18	2,95	0,15	5,0
	64-69		5-E	2	25	2,5	34	18	2,95	0,15	5,0
	69-74		6-E	2	25	2,5	34	18	2,95	0,15	5,0
	74-79		7-E	2	25	2,5	34	18	2,95	0,15	5,0
	79-84		8-E	2	25	2,5	34	18	2,95	0,15	5,0
	Uwaga: Zespół do wytaczania rowków w otworze wymaga:		19-24	AFG0629 30 1582	0-I	1	25	3	34	18	2,95
<ul style="list-style-type: none"> - Axiabore™ Plus - Głowica (A760 03) - Adapter MPA (BDA16BS25100) - Oprawki I (położenie wewnętrzne) i E (położenie zewnętrzne) (BAS25FGI35 i BAS25FGE35) do mocowania narzędzia do rowkowania lub do działania jako przeciwwaga (patrz pozycja ustawienia w tabeli) - Narzędzie do frezowania rowków (AFG...82), które należy wybrać z tabeli, w odniesieniu do szerokości i średnicy rowka. 	24-29	1-I	1		25	3	34	18	2,95	0,15	6,0
	29-34	2-I	1		25	3	34	18	2,95	0,15	6,0
	34-39	3-I	1		25	3	34	18	2,95	0,15	6,0
	39-44	0-E / 4-I	1/2		25	3	34	18	2,95	0,15	6,0
	44-49	1-E / 5-I	1/2		25	3	34	18	2,95	0,15	6,0
	49-54	2-E / 6-I	1/2		25	3	34	18	2,95	0,15	6,0
	54-59	3-E / 7-I	1/2		25	3	34	18	2,95	0,15	6,0
	59-64	4-E / 8-I	1/2		25	3	34	18	2,95	0,15	6,0
	64-69	5-E	2		25	3	34	18	2,95	0,15	6,0
	69-74	6-E	2		25	3	34	18	2,95	0,15	6,0
	74-79	7-E	2		25	3	34	18	2,95	0,15	6,0
	79-84	8-E	2		25	3	34	18	2,95	0,15	6,0

* +0,2 mm (0.008") dodatkowy zakres. ** Zalecane wartości oznaczono **pogrubionym** drukiem. Szczegółowy opis narzędzi do toczenia rowków, patrz strona(y) 601

Całowe Tabela wyboru:

Narzędzie do toczenia rowków - wokół czopu - do toczenia rowków z MPA, do głowic FB 760

Wstęp

Wiercenie

Rozwiercanie

Wytaczanie

Załącznik

Obudowa zespołu 1

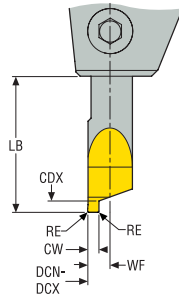
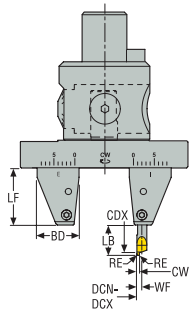

Obudowa zespołu 2

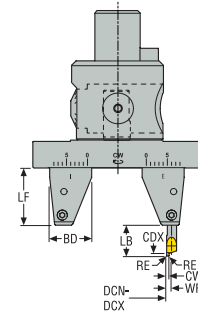

	Zakres DFN-DCX Ø cal.*	Oznaczenie narzędzia do kanałków wokół czopu	Pozycja oprawki do rowków**	Konstrukcja	Wymiary w calach						Maks. głęb. kanałka CDX
					BD	CW	LF	LB	WF	RE	
Wybrać odpowiednie narzędzie do wpustów i zanotować położenie uchwytu narzędzia do wpustów w MPA, aby uzyskać wymagany zakres rowkowania.	0.748-0.945	AFG0629 10 1582	0-I	1	0.984	0.0394	1.339	0.709	0.116	0.006	0.079
	0.945-1.142		1-I	1	0.984	0.0394	1.339	0.709	0.116	0.006	0.079
	1.142-1.339		2-I	1	0.984	0.0394	1.339	0.709	0.116	0.006	0.079
	1.339-1.535		3-I	1	0.984	0.0394	1.339	0.709	0.116	0.006	0.079
	1.535-1.732		0-E / 4-I	1/2	0.984	0.0394	1.339	0.709	0.116	0.006	0.079
	1.732-1.929		1-E / 5-I	1/2	0.984	0.0394	1.339	0.709	0.116	0.006	0.079
	1.929-2.126		2-E / 6-I	1/2	0.984	0.0394	1.339	0.709	0.116	0.006	0.079
	2.126-2.323		3-E / 7-I	1/2	0.984	0.0394	1.339	0.709	0.116	0.006	0.079
	2.323-2.520		4-E / 8-I	1/2	0.984	0.0394	1.339	0.709	0.116	0.006	0.079
	2.520-2.717		5-E	2	0.984	0.0394	1.339	0.709	0.116	0.006	0.079
	2.717-2.913		6-E	2	0.984	0.0394	1.339	0.709	0.116	0.006	0.079
	2.913-3.110		7-E	2	0.984	0.0394	1.339	0.709	0.116	0.006	0.079
3.110-3.307	8-E	2	0.984	0.0394	1.339	0.709	0.116	0.006	0.079		
Uwaga: Zespół do wytaczania rowków w otworze wymaga:	0.748-0.945	AFG0629 15 1582	0-I	1	0.984	0.0591	1.339	0.709	0.116	0.006	0.118
• - Axiabore™ Plus - Głowica (A760 03)	0.945-1.142		1-I	1	0.984	0.0591	1.339	0.709	0.116	0.006	0.118
• Adapter MPA (BDA16BS25100)	1.142-1.339		2-I	1	0.984	0.0591	1.339	0.709	0.116	0.006	0.118
• Oprawki I (położenie wewnętrzne) i E (położenie zewnętrzne) (BAS25FGI35 i BAS25FGE35) do mocowania narzędzia do rowkowania lub do działania jako przeciwwaga (patrz pozycja ustawienia w tabeli)	1.339-1.535		3-I	1	0.984	0.0591	1.339	0.709	0.116	0.006	0.118
	1.535-1.732		0-E / 4-I	1/2	0.984	0.0591	1.339	0.709	0.116	0.006	0.118
	1.732-1.929		1-E / 5-I	1/2	0.984	0.0591	1.339	0.709	0.116	0.006	0.118
	1.929-2.126		2-E / 6-I	1/2	0.984	0.0591	1.339	0.709	0.116	0.006	0.118
	2.126-2.323		3-E / 7-I	1/2	0.984	0.0591	1.339	0.709	0.116	0.006	0.118
	2.323-2.520		4-E / 8-I	1/2	0.984	0.0591	1.339	0.709	0.116	0.006	0.118
	2.520-2.717		5-E	2	0.984	0.0591	1.339	0.709	0.116	0.006	0.118
	2.717-2.913		6-E	2	0.984	0.0591	1.339	0.709	0.116	0.006	0.118
	2.913-3.110		7-E	2	0.984	0.0591	1.339	0.709	0.116	0.006	0.118
	3.110-3.307	8-E	2	0.984	0.0591	1.339	0.709	0.116	0.006	0.118	
	0.748-0.945	AFG0629 20 1582	0-I	1	0.984	0.0787	1.339	0.709	0.116	0.006	0.157
	0.945-1.142		1-I	1	0.984	0.0787	1.339	0.709	0.116	0.006	0.157
	1.142-1.339		2-I	1	0.984	0.0787	1.339	0.709	0.116	0.006	0.157
	1.339-1.535		3-I	1	0.984	0.0787	1.339	0.709	0.116	0.006	0.157
	1.535-1.732		0-E / 4-I	1/2	0.984	0.0787	1.339	0.709	0.116	0.006	0.157
	1.732-1.929		1-E / 5-I	1/2	0.984	0.0787	1.339	0.709	0.116	0.006	0.157
	1.929-2.126		2-E / 6-I	1/2	0.984	0.0787	1.339	0.709	0.116	0.006	0.157
	2.126-2.323		3-E / 7-I	1/2	0.984	0.0787	1.339	0.709	0.116	0.006	0.157
	2.323-2.520		4-E / 8-I	1/2	0.984	0.0787	1.339	0.709	0.116	0.006	0.157
	2.520-2.717		5-E	2	0.984	0.0787	1.339	0.709	0.116	0.006	0.157
	2.717-2.913		6-E	2	0.984	0.0787	1.339	0.709	0.116	0.006	0.157
	2.913-3.110		7-E	2	0.984	0.0787	1.339	0.709	0.116	0.006	0.157
	3.110-3.307	8-E	2	0.984	0.0787	1.339	0.709	0.116	0.006	0.157	

* +0,2 mm (0.008") dodatkowy zakres. ** Zalecane wartości oznaczono pogrubionym drukiem. Szczegółowy opis narzędzi do toczenia rowków, patrz strona(y) 601

Calowe Tabela wyboru:
Narzędzie do toczenia rowków - wokół czopu - do toczenia rowków z MPA, do głowic FB 760

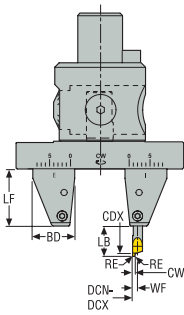
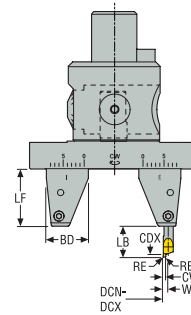
	Zakres DCN-DCX Ø cal.*	Oznaczenie narzędzia do kanałków wokół czopu	Pozycja oprawki do rowków**	Konstrukcja	Wymiary w calach						Maks. głęb. kanałka CDX		
					BD	CW	LF	LB	WF	RE			
<p>Obudowa zespołu 1</p>  <p>Obudowa zespołu 2</p> 	0.748-0.945	AFG0629 25 1582	0-I	1	0.984	0.0984	1.339	0.709	0.116	0.006	0.197		
	0.945-1.142		1-I	1	0.984	0.0984	1.339	0.709	0.116	0.006	0.197		
	1.142-1.339		2-I	1	0.984	0.0984	1.339	0.709	0.116	0.006	0.197		
	1.339-1.535		3-I	1	0.984	0.0984	1.339	0.709	0.116	0.006	0.197		
	1.535-1.732		0-E / 4-I	1/2	0.984	0.0984	1.339	0.709	0.116	0.006	0.197		
	1.732-1.929		1-E / 5-I	1/2	0.984	0.0984	1.339	0.709	0.116	0.006	0.197		
	1.929-2.126		2-E / 6-I	1/2	0.984	0.0984	1.339	0.709	0.116	0.006	0.197		
	2.126-2.323		3-E / 7-I	1/2	0.984	0.0984	1.339	0.709	0.116	0.006	0.197		
	2.323-2.520		4-E / 8-I	1/2	0.984	0.0984	1.339	0.709	0.116	0.006	0.197		
	2.520-2.717		5-E	2	0.984	0.0984	1.339	0.709	0.116	0.006	0.197		
	2.717-2.913		6-E	2	0.984	0.0984	1.339	0.709	0.116	0.006	0.197		
	2.913-3.110		7-E	2	0.984	0.0984	1.339	0.709	0.116	0.006	0.197		
	3.110-3.307		8-E	2	0.984	0.0984	1.339	0.709	0.116	0.006	0.197		
	Uwaga: Zespół do wytaczania rowków w otworze wymaga:		0.748-0.945	AFG0629 30 1582	0-I	1	0.984	0.1181	1.339	0.709	0.116	0.006	0.236
	• - Axiabore™ Plus - Głowica (A760 03)		0.945-1.142		1-I	1	0.984	0.1181	1.339	0.709	0.116	0.006	0.236
• Adapter MPA (BDA16BS25100)	1.142-1.339	2-I	1		0.984	0.1181	1.339	0.709	0.116	0.006	0.236		
• Oprawki I (położenie wewnętrzne) i E (położenie zewnętrzne) (BAS25FGI35 i BAS25FGE35) do mocowania narzędzia do rowkowania lub do działania jako przeciwwaga (patrz pozycja ustawienia w tabeli)	1.339-1.535	3-I	1		0.984	0.1181	1.339	0.709	0.116	0.006	0.236		
	1.535-1.732	0-E / 4-I	1/2		0.984	0.1181	1.339	0.709	0.116	0.006	0.236		
	1.732-1.929	1-E / 5-I	1/2		0.984	0.1181	1.339	0.709	0.116	0.006	0.236		
	1.929-2.126	2-E / 6-I	1/2		0.984	0.1181	1.339	0.709	0.116	0.006	0.236		
	2.126-2.323	3-E / 7-I	1/2		0.984	0.1181	1.339	0.709	0.116	0.006	0.236		
	2.323-2.520	4-E / 8-I	1/2		0.984	0.1181	1.339	0.709	0.116	0.006	0.236		
	2.520-2.717	5-E	2		0.984	0.1181	1.339	0.709	0.116	0.006	0.236		
	2.717-2.913	6-E	2		0.984	0.1181	1.339	0.709	0.116	0.006	0.236		
	2.913-3.110	7-E	2		0.984	0.1181	1.339	0.709	0.116	0.006	0.236		
	3.110-3.307	8-E	2		0.984	0.1181	1.339	0.709	0.116	0.006	0.236		

* +0,2 mm (0.008") dodatkowy zakres. ** Zalecane wartości oznaczono pogrubionym drukiem. Szczegółowy opis narzędzi do toczenia rowków, patrz strona(y) 601

Metryczne Tabela wyboru:

Narzędzie do toczenia rowków - na dnie otworu- do toczenia rowków z MPA, do głowic FB 760

Wstęp

Wiercenie

Rozwiercanie

Wytaczanie

Załącznik

Obudowa zespołu 3

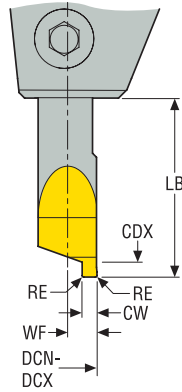
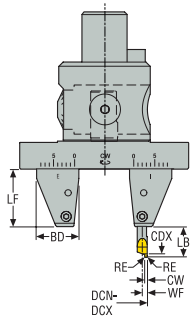

Obudowa zespołu 4

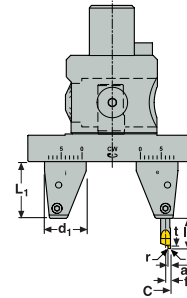

	Zakres DCN-DCX Ø mm*	Oznaczenie narzędzia do kanałków na dnie otworu	Pozycja oprawki do rowków**	Konstrukcja	Wymiary w mm						Maks. głęb. kanałka CDX
					BD	CW	LF	LB	WF	RE	
Wybrać odpowiednie narzędzie do wpuśców i zanotować położenie uchwytu narzędzia do wpuśców w MPA, aby uzyskać wymagany zakres rowkowania.	31-36	AFG0629 10 1581	0-I	3	25	1	34	18	2,95	0,15	2,0
	36-41		1-I	3	25	1	34	18	2,95	0,15	2,0
	41-46		2-I	3	25	1	34	18	2,95	0,15	2,0
	46-51		3-I	3	25	1	34	18	2,95	0,15	2,0
	51-56		0-E / 4-I	3/4	25	1	34	18	2,95	0,15	2,0
	56-61		1-E / 5-I	3/4	25	1	34	18	2,95	0,15	2,0
	61-66		2-E / 6-I	3/4	25	1	34	18	2,95	0,15	2,0
	66-71		3-E / 7-I	3/4	25	1	34	18	2,95	0,15	2,0
	71-76		4-E / 8-I	3/4	25	1	34	18	2,95	0,15	2,0
	76-81		5-E	4	25	1	34	18	2,95	0,15	2,0
	81-86		6-E	4	25	1	34	18	2,95	0,15	2,0
	86-91		7-E	4	25	1	34	18	2,95	0,15	2,0
91-96	8-E	4	25	1	34	18	2,95	0,15	2,0		
Uwaga: Zespół do wytaczania rowków w otworze wymaga:	31-36	AFG0629 15 1581	0-I	3	25	1,5	34	18	2,95	0,15	3,0
	39-41		1-I	3	25	1,5	34	18	2,95	0,15	3,0
	41-46		2-I	3	25	1,5	34	18	2,95	0,15	3,0
	46-51		3-I	3	25	1,5	34	18	2,95	0,15	3,0
	51-56		0-E / 4-I	3/4	25	1,5	34	18	2,95	0,15	3,0
	56-61		1-E / 5-I	3/4	25	1,5	34	18	2,95	0,15	3,0
	61-66		2-E / 6-I	3/4	25	1,5	34	18	2,95	0,15	3,0
	66-71		3-E / 7-I	3/4	25	1,5	34	18	2,95	0,15	3,0
	71-76		4-E / 8-I	3/4	25	1,5	34	18	2,95	0,15	3,0
	76-81		5-E	4	25	1,5	34	18	2,95	0,15	3,0
	81-86		6-E	4	25	1,5	34	18	2,95	0,15	3,0
	86-91		7-E	4	25	1,5	34	18	2,95	0,15	3,0
91-96	8-E	4	25	1,5	34	18	2,95	0,15	3,0		
	31-36	AFG0629 20 1581	0-I	3	25	2	34	18	2,95	0,15	4,0
	39-41		1-I	3	25	2	34	18	2,95	0,15	4,0
	41-46		2-I	3	25	2	34	18	2,95	0,15	4,0
	46-51		3-I	3	25	2	34	18	2,95	0,15	4,0
	51-56		0-E / 4-I	3/4	25	2	34	18	2,95	0,15	4,0
	56-61		1-E / 5-I	3/4	25	2	34	18	2,95	0,15	4,0
	61-66		2-E / 6-I	3/4	25	2	34	18	2,95	0,15	4,0
	66-71		3-E / 7-I	3/4	25	2	34	18	2,95	0,15	4,0
	71-76		4-E / 8-I	3/4	25	2	34	18	2,95	0,15	4,0
	76-81		5-E	4	25	2	34	18	2,95	0,15	4,0
	81-86		6-E	4	25	2	34	18	2,95	0,15	4,0
	86-91		7-E	4	25	2	34	18	2,95	0,15	4,0
91-96	8-E	4	25	2	34	18	2,95	0,15	4,0		

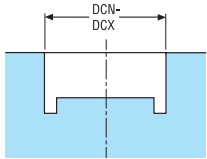

* +0,2 mm (0.008") dodatkowy zakres. ** Zalecane wartości oznaczono pogrubionym drukiem. Szczegółowy opis narzędzi do toczenia rowków, patrz strona(y) 601

Metryczne Tabela wyboru:
Narzędzie do toczenia rowków - na dnie otworu - do toczenia rowków z MPA, do głowic FB 760

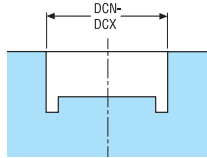
	Zakres DCN-DCX Ø mm*	Oznaczenie narzędzia do kanałków na dnie otworu	Pozycja oprawki do rowków**	Konstrukcja	Wymiary w mm						Maks. głęb. kanałka CDX
					BD	CW	LF	LB	WF	RE	
<p>Wybrać odpowiednie narzędzie do wpuścić i zanotować położenie uchwytu narzędzia do wpuścić w MPA, aby uzyskać wymagany zakres rowkowania.</p> 	31-36	AFG0629 25 1581	0-I	3	25	2,5	34	18	2,95	0,15	5,0
	36-41		1-I	3	25	2,5	34	18	2,95	0,15	5,0
	41-46		2-I	3	25	2,5	34	18	2,95	0,15	5,0
	46-51		3-I	3	25	2,5	34	18	2,95	0,15	5,0
	51-56		0-E / 4-I	3/4	25	2,5	34	18	2,95	0,15	5,0
	56-61		1-E / 5-I	3/4	25	2,5	34	18	2,95	0,15	5,0
	61-66		2-E / 6-I	3/4	25	2,5	34	18	2,95	0,15	5,0
	66-71		3-E / 7-I	3/4	25	2,5	34	18	2,95	0,15	5,0
	71-76		4-E / 8-I	3/4	25	2,5	34	18	2,95	0,15	5,0
	76-81		5-E	4	25	2,5	34	18	2,95	0,15	5,0
	81-86		6-E	4	25	2,5	34	18	2,95	0,15	5,0
	86-91		7-E	4	25	2,5	34	18	2,95	0,15	5,0
	91-96		8-E	4	25	2,5	34	18	2,95	0,15	5,0
	<p>Uwaga: Zespół do wytaczania rowków w otworze wymaga:</p> <ul style="list-style-type: none"> Głowica - Axiabore™ Plus - (A760 03) Adapter MPA (BDA16BS25100) Oprawki I (pozycja wewnętrzna) i E (pozycja zewnętrzna) (BAS25FGI35 i BAS25FGE35) służą do mocowania wytaczaków oraz jako przeciwwaga (patrz tabela pozycji ustawienia) Narzędzie do kanałków na dnie otworu (AFG...81) należy wybrać z tabeli, zależnie od średnicy i szerokości. 		31-36	AFG0629 30 1581	0-I	3	25	3	34	18	2,95
39-41		1-I	3		25	3	34	18	2,95	0,15	6,0
41-46		2-I	3		25	3	34	18	2,95	0,15	6,0
46-51		3-I	3		25	3	34	18	2,95	0,15	6,0
51-56		0-E / 4-I	3/4		25	3	34	18	2,95	0,15	6,0
56-61		1-E / 5-I	3/4		25	3	34	18	2,95	0,15	6,0
61-66		2-E / 6-I	3/4		25	3	34	18	2,95	0,15	6,0
66-71		3-E / 7-I	3/4		25	3	34	18	2,95	0,15	6,0
71-76		4-E / 8-I	3/4		25	3	34	18	2,95	0,15	6,0
76-81		5-E	4		25	3	34	18	2,95	0,15	6,0
81-86	6-E	4	25	3	34	18	2,95	0,15	6,0		
86-91	7-E	4	25	3	34	18	2,95	0,15	6,0		
91-96	8-E	4	25	3	34	18	2,95	0,15	6,0		

* +0,2 mm (0.008") dodatkowy zakres. ** Zalecane wartości oznaczono **pogrubionym** drukiem. Szczegółowy opis narzędzi do toczenia rowków, patrz strona(y) 601

Całowe Tabela wyboru:

Narzędzie do toczenia rowków - na dnie otworu - do toczenia rowków z MPA, do głowic FB 760

Wstęp

Wiercenie

Rozwiercanie

Wytaczanie

Załącznik

Obudowa zespołu 3

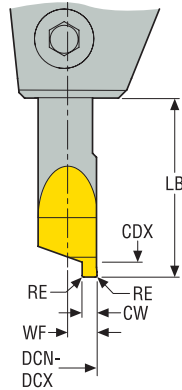
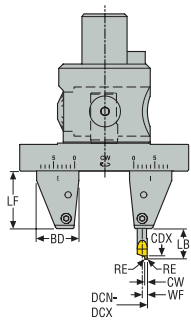

Obudowa zespołu 4

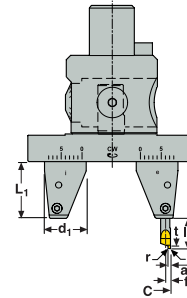

	Zakres DCN-DCX ∅ cal.*	Oznaczenie narzędzia do kanałków na dnie otworu	Pozycja oprawki do rowków**	Konstrukcja	Wymiary w calach						Maks. głęb. kanałka CDX
					BD	CW	LF	LB	WF	RE	
Wybrać odpowiednie narzędzie do wpuśców i zanotować położenie uchwytu narzędzia do wpuśców w MPA, aby uzyskać wymagany zakres rowkowania.	1.220-1.417	AFG0629 10 1581	0-I	3	0.984	0.0394	1.339	0.709	0.116	0.006	0.079
	1.417-1.614		1-I	3	0.984	0.0394	1.339	0.709	0.116	0.006	0.079
	1.614-1.811		2-I	3	0.984	0.0394	1.339	0.709	0.116	0.006	0.079
	1.811-2.008		3-I	3	0.984	0.0394	1.339	0.709	0.116	0.006	0.079
	2.008-2.205		0-E / 4-I	3/4	0.984	0.0394	1.339	0.709	0.116	0.006	0.079
	2.205-2.402		1-E / 5-I	3/4	0.984	0.0394	1.339	0.709	0.116	0.006	0.079
	2.402-2.598		2-E / 6-I	3/4	0.984	0.0394	1.339	0.709	0.116	0.006	0.079
	2.598-2.795		3-E / 7-I	3/4	0.984	0.0394	1.339	0.709	0.116	0.006	0.079
	2.795-2.992		4-E / 8-I	3/4	0.984	0.0394	1.339	0.709	0.116	0.006	0.079
	2.992-3.189		5-E	4	0.984	0.0394	1.339	0.709	0.116	0.006	0.079
	3.189-3.386		6-E	4	0.984	0.0394	1.339	0.709	0.116	0.006	0.079
	3.386-3.583		7-E	4	0.984	0.0394	1.339	0.709	0.116	0.006	0.079
3.583-3.780	8-E	4	0.984	0.0394	1.339	0.709	0.116	0.006	0.079		
Uwaga: Zespół do wytaczania rowków w otworze wymaga:	1.220-1.417	AFG0629 15 1581	0-I	3	0.984	0.0591	1.339	0.709	0.116	0.006	0.118
• Głowica - Axiabore™ Plus - (A760 03)	1.417-1.614		1-I	3	0.984	0.0591	1.339	0.709	0.116	0.006	0.118
• Adapter MPA (BDA16BS25100)	1.614-1.811		2-I	3	0.984	0.0591	1.339	0.709	0.116	0.006	0.118
• Oprawki I (pozycja wewnętrzna) i E (pozycja zewnętrzna) (BAS25FGI35 i BAS25FGE35) służą do mocowania wytaczaków oraz jako przeciwwaga (patrz tabela pozycji ustawienia)	1.811-2.008		3-I	3	0.984	0.0591	1.339	0.709	0.116	0.006	0.118
• Narzędzie do kanałków na dnie otworu (AFG...81) należy wybrać z tabeli, zależnie od średnicy i szerokości.	2.008-2.205		0-E / 4-I	3/4	0.984	0.0591	1.339	0.709	0.116	0.006	0.118
	2.205-2.402		1-E / 5-I	3/4	0.984	0.0591	1.339	0.709	0.116	0.006	0.118
	2.402-2.598		2-E / 6-I	3/4	0.984	0.0591	1.339	0.709	0.116	0.006	0.118
	2.598-2.795		3-E / 7-I	3/4	0.984	0.0591	1.339	0.709	0.116	0.006	0.118
	2.795-2.992		4-E / 8-I	3/4	0.984	0.0591	1.339	0.709	0.116	0.006	0.118
	2.992-3.189		5-E	4	0.984	0.0591	1.339	0.709	0.116	0.006	0.118
	3.189-3.386		6-E	4	0.984	0.0591	1.339	0.709	0.116	0.006	0.118
	3.386-3.583		7-E	4	0.984	0.0591	1.339	0.709	0.116	0.006	0.118
	3.583-3.780	8-E	4	0.984	0.0591	1.339	0.709	0.116	0.006	0.118	
	1.220-1.417	AFG0629 20 1581	0-I	3	0.984	0.0787	1.339	0.709	0.116	0.006	0.157
	1.417-1.614		1-I	3	0.984	0.0787	1.339	0.709	0.116	0.006	0.157
	1.614-1.811		2-I	3	0.984	0.0787	1.339	0.709	0.116	0.006	0.157
	1.811-2.008		3-I	3	0.984	0.0787	1.339	0.709	0.116	0.006	0.157
	2.008-2.205		0-E / 4-I	3/4	0.984	0.0787	1.339	0.709	0.116	0.006	0.157
	2.205-2.402		1-E / 5-I	3/4	0.984	0.0787	1.339	0.709	0.116	0.006	0.157
	2.402-2.598		2-E / 6-I	3/4	0.984	0.0787	1.339	0.709	0.116	0.006	0.157
	2.598-2.795		3-E / 7-I	3/4	0.984	0.0787	1.339	0.709	0.116	0.006	0.157
	2.795-2.992		4-E / 8-I	3/4	0.984	0.0787	1.339	0.709	0.116	0.006	0.157
	2.992-3.189		5-E	4	0.984	0.0787	1.339	0.709	0.116	0.006	0.157
	3.189-3.386		6-E	4	0.984	0.0787	1.339	0.709	0.116	0.006	0.157
	3.386-3.583		7-E	4	0.984	0.0787	1.339	0.709	0.116	0.006	0.157
	3.583-3.780	8-E	4	0.984	0.0787	1.339	0.709	0.116	0.006	0.157	

* +0,2 mm (0.008") dodatkowy zakres. ** Zalecane wartości oznaczono pogrubionym drukiem. Szczegółowy opis narzędzi do toczenia rowków, patrz strona(y) 601

Calowe Tabela wyboru:
Narzędzie do toczenia rowków - na dnie otworu - do toczenia rowków z MPA, do głowic FB 760

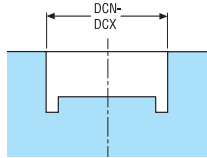
	Zakres DCN-DCX Ø cal.*	Oznaczenie narzędzia do kanałków na dnie otworu	Pozycja oprawki do rowków**	Konstrukcja	Wymiary w calach						Maks. głęb. kanałka CDX
					BD	CW	LF	LB	WF	RE	
<p>Wybrać odpowiednie narzędzie do wpuścić i zanotować położenie uchwytu narzędzia do wpuścić w MPA, aby uzyskać wymagany zakres rowkowania.</p> 	1.220-1.417	AFG0629 25 1581	0-I	3	0.984	0.0984	1.339	0.709	0.116	0.006	0.197
	1.417-1.614		1-I	3	0.984	0.0984	1.339	0.709	0.116	0.006	0.197
	1.614-1.811		2-I	3	0.984	0.0984	1.339	0.709	0.116	0.006	0.197
	1.811-2.008		3-I	3	0.984	0.0984	1.339	0.709	0.116	0.006	0.197
	2.008-2.205		0-E / 4-I	3/4	0.984	0.0984	1.339	0.709	0.116	0.006	0.197
	2.205-2.402		1-E / 5-I	3/4	0.984	0.0984	1.339	0.709	0.116	0.006	0.197
	2.402-2.598		2-E / 6-I	3/4	0.984	0.0984	1.339	0.709	0.116	0.006	0.197
	2.598-2.795		3-E / 7-I	3/4	0.984	0.0984	1.339	0.709	0.116	0.006	0.197
	2.795-2.992		4-E / 8-I	3/4	0.984	0.0984	1.339	0.709	0.116	0.006	0.197
	2.992-3.189		5-E	4	0.984	0.0984	1.339	0.709	0.116	0.006	0.197
	3.189-3.386		6-E	4	0.984	0.0984	1.339	0.709	0.116	0.006	0.197
	3.386-3.583		7-E	4	0.984	0.0984	1.339	0.709	0.116	0.006	0.197
	3.583-3.780		8-E	4	0.984	0.0984	1.339	0.709	0.116	0.006	0.197
	<p>Uwaga: Zespół do wytaczania rowków w otworze wymaga:</p> <ul style="list-style-type: none"> Głowica - Axiabore™ Plus - (A760 03) Adapter MPA (BDA16BS25100) Oprawki I (pozycja wewnętrzna) i E (pozycja zewnętrzna) (BAS25FGI35 i BAS25FGE35) służą do mocowania wytaczaków oraz jako przeciwwaga (patrz tabela pozycji ustawienia) Narzędzie do kanałków na dnie otworu (AFG...81) należy wybrać z tabeli, zależnie od średnicy i szerokości. 		1.220-1.417	AFG0629 30 1581	0-I	3	0.984	0.1181	1.339	0.709	0.116
1.417-1.614		1-I	3		0.984	0.1181	1.339	0.709	0.116	0.006	0.236
1.614-1.811		2-I	3		0.984	0.1181	1.339	0.709	0.116	0.006	0.236
1.811-2.008		3-I	3		0.984	0.1181	1.339	0.709	0.116	0.006	0.236
2.008-2.205		0-E / 4-I	3/4		0.984	0.1181	1.339	0.709	0.116	0.006	0.236
2.205-2.402		1-E / 5-I	3/4		0.984	0.1181	1.339	0.709	0.116	0.006	0.236
2.402-2.598		2-E / 6-I	3/4		0.984	0.1181	1.339	0.709	0.116	0.006	0.236
2.598-2.795		3-E / 7-I	3/4		0.984	0.1181	1.339	0.709	0.116	0.006	0.236
2.795-2.992		4-E / 8-I	3/4		0.984	0.1181	1.339	0.709	0.116	0.006	0.236
2.992-3.189		5-E	4		0.984	0.1181	1.339	0.709	0.116	0.006	0.236
3.189-3.386		6-E	4		0.984	0.1181	1.339	0.709	0.116	0.006	0.236
3.386-3.583		7-E	4		0.984	0.1181	1.339	0.709	0.116	0.006	0.236
3.583-3.780		8-E	4		0.984	0.1181	1.339	0.709	0.116	0.006	0.236

* +0,2 mm (0.008") dodatkowy zakres. ** Zalecane wartości oznaczono pogrubionym drukiem. Szczegółowy opis narzędzi do toczenia rowków, patrz strona(y) 601

Instrukcje

Maksymalne prędkości dla głowic typu Axiabore™

Więcej informacji można znaleźć w instrukcjach dostarczanych z głowicami oraz oprawkami GL.

Wielkość głowicy	Zakres \varnothing mm (cale)	Maks. obr./min z wytaczakiem (obr./min)	Maks. obr./min z MPA (obr./min)	Maks. prędkość skrawania V_c przy min. zakresie m/min (sf/min)	Maks. prędkość skrawania V_c przy maks. zakresie m/min (sf/min)
Typ Axiabore™ z połączeniem Graflex®					
A76001	0,3-8 (0.0118-0.315)	30000	–	28* (92*)	754* (2474*)
A76002	2-20 (0.0787-0.787)	12000	–	75* (246*)	754* (2474*)
A76003	6-108 (0.236-4.25)	8000**	5000	151* (495*)	1000*** (3281***)
A76013	6-33 (0.236-1.30)	20000**	5000	377* (1237*)	1500*** (4921***)
Typ Axiabore™ z połączeniem Seco-Capto™					
C5-391.0760-03	6-108 (0.236-4.25)	8000*	5000	151* (495*)	1000** (3281**)

Uwaga: Maksymalne prędkości pokazane na stronach produktów dotyczą samej konstrukcji oraz jakości wyważenia głowicy. Zastosowana prędkość powinna także uwzględniać inne warunki pracy np. obrabiany materiał, płytkę, długość narzędzia, wrzeciono obrabiarki. Przy prędkościach od ok. 8000 obr./min i wyższych, oprawki podstawowe i elementy pośrednie powinny być dokładnie wyważone. Zastosowanie głowic z możliwością wyważania i dokładnie wyważonych oprawek zwiększa trwałość narzędzia i wydajność wytaczania nawet przy niższych prędkościach.

* Domniemana maksymalna prędkość skrawania przy maks obr./min.

** Niedostępny dla wszystkich narzędzi, patrz: ***.

*** Nie wolno przekraczać maksymalnej prędkości skrawania

Instrukcje rozwiązywania problemów (dotyczy też głowic typu promieniowego do dokładnego wytaczania)

Problem	Prawdopodobna przyczyna	Rozwiązanie
Mała trwałość ostrza	Nieprawidłowy gatunek płytki	Wymienić na płytkę bardziej odporną na ścieranie
	Nadmierna prędkość skrawania	Zmniejszyć prędkość skrawania.
	Za duża głębokość skrawania	Zmniejszyć warstwę
Drgania	Nadmierna prędkość skrawania	Zmniejszyć prędkość skrawania.
	Duży stosunek L/D	Skrócić narzędzie w celu zwiększenia sztywności
		Zastosować mocniejsze narzędzie do wytaczania
		Użyć oprawki Steadyline
		Użyć przedłużek z węgla lub ciężkiego metalu
Nieprawidłowa płytka	Zmniejszyć promień naroża płytki Stosować płytki o szlifowanej geometrii	
Nieprawidłowy naddatek na obróbkę	Zmienić średnicę otworu wstępnego	
Średnica otworu poza tolerancją i brak powtarzalności	Niedokładnie przeprowadzona zmiana narzędzia	Zużyty i zniszczony chwyt narzędzia: wymienić Oczyszczyć wrzeciono i chwyt narzędzia
	Zmienny naddatek na obróbkę	Dodać obróbkę pół-wykańczającą
	Mała stabilność wrzeciona	Stosować płytki o ostrzejszej szlifowanej geometrii
Błąd kołowości otworu	Nadmierne niewyważenie narzędzia do wytaczania	Sprawdzić bicie wrzeciona
		Zmień na głowicę LIBRAFLEX®
		Sprawdzić ustawienie pierścienia wyważającego
		Zmniejszyć prędkość
	Zbyt duże siły skrawania	Sprawdzić naddatek na obróbkę i wartość posuwu
Niewystarczające zamocowanie detalu	Sprawdzić zamocowanie detalu	
Nie symetryczny detal	Zmniejszyć siły skrawania, zastosować płytkę szlifowaną	
	Zwiększyć prędkość skrawania, zmniejszyć wartość posuwu	
Błąd położenie otworu	Otwór wstępny nieliniowy	Dodać wytaczanie półwykańczające
	Za duża głębokość skrawania	Zmniejszyć warstwę, wykonać dwa przejścia
Zła jakość powierzchni	Nieprawidłowy promień płytki wymiennej	Zastosować większy promień płytki
	Nadmierna wartość posuwu	Zmniejszyć posuw do maks. 30% promienia naroża płytki
		Zastosuj chłodzenie wewnętrzne
	Nieprawidłowe usuwanie wiórów	Zmienić na płytkę z większym kątem natarcia (HSS)
		Sprawdzić warstwę
Otwór stożkowy	Przedwczesne zużycie ostrza	Wymienić na płytkę bardziej odporną na ścieranie
		Zmienić prędkość skrawania
		Zwiększyć przepływ chłodziwa

Ogólny opis

Wstęp

Wiercenie

Rozwiercanie

Wytaczanie

Zalącznik

Graflex®

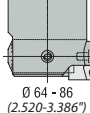
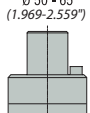
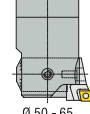
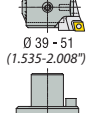
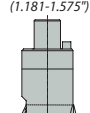
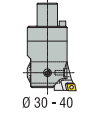
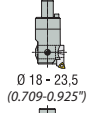
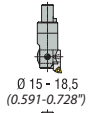

Graflex® z możliwością wyważenia

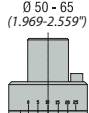
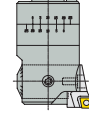
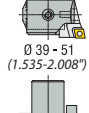
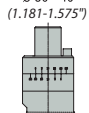
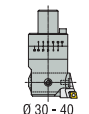

Seco-Capto™

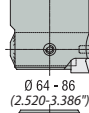
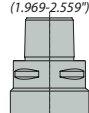
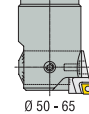
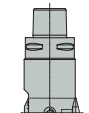

Połączenie GL



Połączenie BA

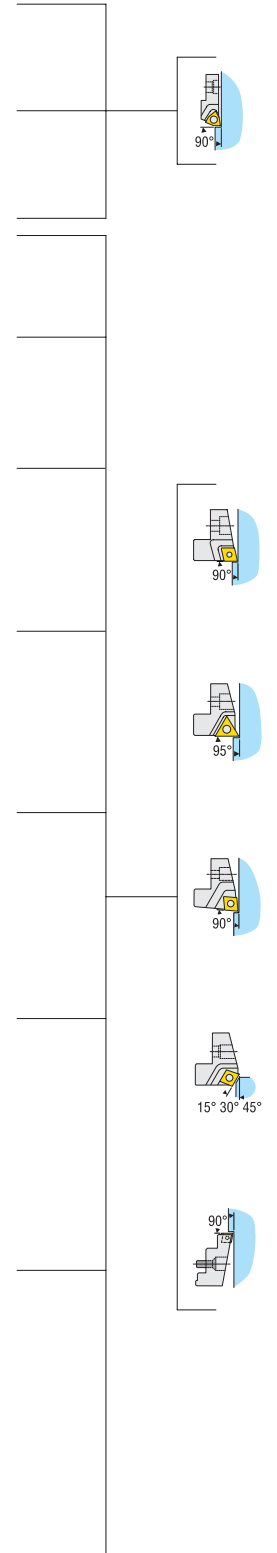
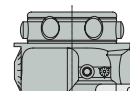
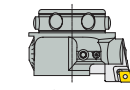

Głowice do dokładnego wytaczania — przewodnik

Właściwości

Głowica typu promieniowego do dokładnego wytaczania składa się z korpusu (głowica) oraz wkładki z płytką wymienną. FB 620, FB 780 i FB 790 promieniowe, głowice do wytaczania na gotowo:

Asortyment

Seco oferuje szeroki asortyment promieniowych głowic na gotowo:

FB 620, FB 780 i FB 790 promieniowe, głowice do wytaczania na gotowo:



- Regulacja mikrometryczna: Mechanizm regulacji wkładki za pomocą śruby mikrometrycznej, 1 skok = 0,01 mm (0.0004") na średnicy oraz na skali noniusza, dokładność 2,5 µm (98.4 µcala) na średnicy.
- Precyzja mechanizmu zapewnia powtarzalność.
- Ustawienie katowe krawędzi skrawającej zgodnie z DIN 69871/ISO 7388 dla SA oraz ISO 12164 dla HSK.
- Chłodziwo przepływające przez głowicę kierowane jest na krawędź skrawającą.
- Głowice FB 780 i FB 620 są wstępnie wyważone dla środkowego ustawienia. Głowica FB 790 jest wstępnie wyważona, dla optymalnej wydajności.

Uwaga: Opisy, instrukcje (mocowanie wkładek, nastawianie średnicy, wytaczanie wsteczne, rozwiązywanie problemów, zalecane warunki obróbki, maksymalne prędkości), odpowiednie wkładki oraz płytki są takie same dla wszystkich typów głowic zgrubnych FB 620, FB 780 i FB 790 w odpowiednich zakresach, bez względu na typ połączenia.

Głowice do dokładnego wytaczania FB 620, typu promieniowego do opravek Steadyline®



GL



BA

- 4 głowice do wytaczania precyzyjnego z połączeniem GL po stronie obrabiarki do precyzyjnych otworów Ø 27–69 mm (Ø 1.102–2.717")
- 2 głowice do wytaczania precyzyjnego z połączeniem BA po stronie obrabiarki do precyzyjnych otworów Ø 66–116 mm (Ø 2.598–4.567")

Ta kompaktowa konstrukcja uzyskuje najlepsze własności tłumienia drgań razem z oprawką Steadyline® z połączeniem GL.

Głowice FB 780 do dokładnego wytaczania, typu promieniowego

9 głowic do wytaczania na gotowo z połączeniem Graflex® od strony obrabiarki do wytaczania w zakresie od \varnothing 15-205 mm (\varnothing 0.591-8.071") z promieniowo zamocowanymi wkładkami.

5 głowic do wytaczania precyzyjnego z połączeniem Seco-Capto™ po stronie obrabiarki do precyzyjnego wytaczania \varnothing 39–205 mm (\varnothing 1.535–8.071").

Adapter Seco-Capto™ i głowice Graflex®: \varnothing 15–40 mm (\varnothing 0.591–1.575").

Uwaga: Minimalna średnica otworu dla głowicy na gotowo Seco-Capto™ wynosi \varnothing 39 mm (\varnothing 1.535") z najmniejszym dostępnym mocowaniem Seco-Capto™ C3. W zakresie \varnothing 15-40 mm (\varnothing 0.591-1.575") należy stosować głowice Graflex® z połączeniem o wielkości G0 do G2 razem z adapterem Seco-Capto™/Graflex®. Stosując przedłużki Graflex® mamy możliwość przedłużenia narzędzia.

Uwaga: Opisy, instrukcje (mocowanie wkładek, nastawianie średnicy, wytaczanie wsteczne, rozwiązywanie problemów, zalecane warunki obróbki, maksymalne prędkości), odpowiednie wkładki oraz płytki są podobne dla obu typów głowic na gotowo FB 780 w odpowiednich zakresach, bez względu na typ połączenia.

Głowice FB 790 z możliwością wyważenia do dokładnego wytaczania, typu promieniowego

5 głowic do wytaczania z możliwością wyważenia „Libraflex®” z połączeniem Graflex® po stronie obrabiarki do precyzyjnego wytaczania \varnothing 30–115 mm (\varnothing 1.181–4.528") przy dużych prędkościach, do 1500 m/min (4921 stóp/min), z wykorzystaniem promieniowo zamocowanych wkładek na płytce.

Wyważenie minimalizuje obciążenie wrzeciona, oraz umożliwia lepszą optymalizację parametrów, zapewnią lepszą jakość otworu nawet przy normalnych parametrach.

Wyważenie jest realizowane poprzez ustawienie obu pierścieni zgodnie ze średnicą wytaczanego otworu.



Właściwości

Wkładki

Głowica promieniowa do dokładnego wytaczania składa się z korpusu (głowica) oraz wkładki z płytką wymienną.

Szeroki asortyment wkładek do dokładnego wytaczania, fazowania i wytaczania wstecznego ma zastosowanie do głowic FB 780, FB 790 i FB 620, typu promieniowego.

Wkładki do wytaczania na gotowo

FBIH 782: kąt przystawienia 90° dla płytek WB
 FBIH 724: kąt przystawienia 90° dla płytek TC
 FBIH 725: kąt przystawienia 90° dla płytek CC
 FBIH 726: kąt przystawienia 95° dla płytek CC

Uwaga: Kąt przystawienia wkładki 95° jest zalecany, aby uniknąć zetknięcia z powierzchnią czołową podczas wytaczania do kołnierza.

Wkładki do fazowania, od $\varnothing 23$ do 160 mm ($\varnothing 0.906$ - 6.299 ")

FBIH 729: dostępne z kątem przystawienia 15°, 30° lub 45° dla płytek CC.

Wyważenie Libraflex® można również uzyskać podczas stosowania wkładki do fazowania.

Wkładki do wytaczania wstecznego, od $\varnothing 26,5$ do 164 mm ($\varnothing 1.043$ - 6.457 ")

FBIH A789: kąt przystawienia 90° dla płytek WB i CC.

Dokładne wyważenie Libraflex® nie jest możliwe w przypadku stosowania wkładek do wytaczania wstecznego. W tym przypadku, największe zredukowanie niewyważenia można uzyskać, gdy oba pierścienie wyważające są ustawione na największą wartość podziałki.

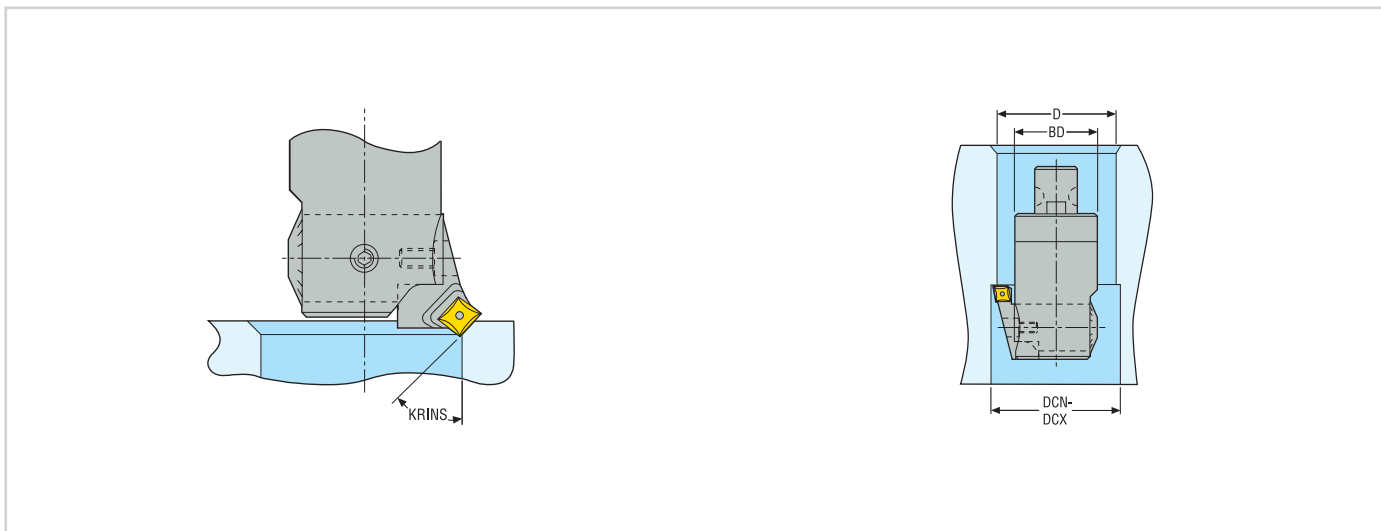

FB780

Graflex®

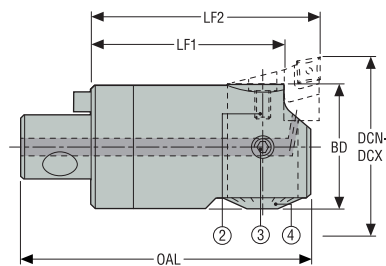

- Z regulacją mikrometryczną (skok 0,01 mm i noniusz 2,5 µm, na średnicy)

2. Śruba montażowa
3. Śruba mocująca
4. Mikrometryczna śruba regulacyjna

Numer produktu	Oznaczenie	Wielk. Graflex	Od strony detalu		Zakres DCN-DCX Ø	OAL	LF1	LF2	BD	Waga	Oprawka
			mm Cal.	mm Cal.							
00056632	A78008	G0	15,0 0.591	18,5 0.728	44,0 1.732	27,5 1.083	35,0 1.378	14,0 0.551	0,1 0.220	09	
00056633	A78009	G0	18,0 0.709	23,5 0.925	44,0 1.732	27,5 1.083	35,0 1.378	17,0 0.669	0,1 0.220	09	
00072991	A78010	G1	23,0 0.906	31,0 1.220	51,5 2.028	32,5 1.280	40,0 1.575	21,5 0.846	0,11 0.240	10	
00072992	A78020	G2	30,0 1.181	40,0 1.575	59,5 2.343	37,5 1.476	45,0 1.772	27,0 1.063	0,22 0.490	20	
00072993	A78030	G3	39,0 1.535	51,0 2.008	82,0 3.228	54,5 2.146	65,0 2.559	35,0 1.378	0,5 1.100	30	
00072995	A78040	G4	50,0 1.969	65,0 2.559	93,0 3.661	61,5 2.421	72,0 2.835	43,0 1.693	0,9 1.980	40	
00072996	A78050	G5	64,0 2.520	86,0 3.386	109,0 4.291	71,5 2.815	82,0 3.228	54,0 2.126	1,49 3.280	50	
00056551	A78060	G6	85,0 3.346	144,0 5.669	140,0 5.512	88,5 3.484	105,0 4.134	70,0 2.756	3,2 7.050	60/65	
00056552	A78070	G7	114,0 4.488	205,0 8.071	160,0 6.299	98,5 3.878	115,0 4.528	95,0 3.740	6,3 13.890	70/75	

Wkładki należy zamawiać oddzielnie, patrz strona(y) 626, 627-629

Uwaga: Waga podana bez wkładki

Części zamienne, zawarte w dostawie

Dla	Śruba mocująca	Klucz (Typu T)	Klucz	Śruba mocująca	Zabierak
A78008	960D30050S	DOUBLE-T	H4B-H2.0	19A7100403	-
A78009	-	DOUBLE-T	H4B-H2.0	19A71000	90M0
A78010	19TB0305	DOUBLE-T	H4B-H2.0	19A71000	90M1
A78020	19TB0305	H4B-H2.0	-	950L0406	90M2
A78030	19TB04075	-	03M03C	950L0608	90M3
A78040	19TB04075	-	03M03C	950L0612	90M4
A78050	950D0410	-	03M03C	950L0616	90M5
A78060	950D0612	DOUBLE-T	H6B-H5.0L	950L1016	90M6
A78070	950D0616	DOUBLE-T	H6B-H5.0L	950L1030	90M7

Wstęp

Wiercenie

Rozwiercanie

Wytaczanie

Załącznik

Akcesoria

Dla		Klucz dynamometryczny do śrub mocujących
		
A78008		H00-2009
A78009		H00-2009
A78010		H00-2009
A78020		H00-2009
A78030		H00-3030
A78040		H00-3030
A78050		H00-3030
A78060		H00T-50100
A78070		H00T-50100

FB780

Seco-Capto™

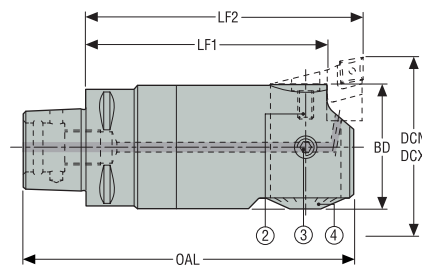

- Z regulacją mikrometryczną (skok 0,01 mm i noniusz 2,5 µm, na średnicy)

2. Śruba montażowa
3. Śruba mocująca
4. Mikrometryczna śruba regulacyjna

Oznaczenie	Numer produktu	Wielkość Capto	Od strony detalu Zakres DCN-DCX Ø		OAL	LF1	LF2	BD	Waga	Oprawk
			mm	mm						
C3-391.0780-30	02809740	C3	39,0 1.535	51,0 2.008	86,0 3.386	59,5 2.343	70,0 2.756	35,0 1.378	0,48 1.060	30
C4-391.0780-40	02809742	C4	50,0 1.969	65,0 2.559	103,0 4.055	71,5 2.815	82,0 3.228	43,0 1.693	0,89 1.960	40
C5-391.0780-50	02809744	C5	64,0 2.520	86,0 3.386	119,0 4.685	81,5 3.209	92,0 3.622	54,0 2.126	1,62 3.570	50
C6-391.0780-60	02809745	C6	85,0 3.346	144,0 5.669	150,0 5.906	100,5 3.957	117,0 4.606	70,0 2.756	3,3 7.280	60
C8-391.0780-70	02809747	C8	114,0 4.488	205,0 8.071	181,0 7.126	121,5 4.783	138,0 5.433	95,0 3.740	7,15 15.760	70

Wkładki należy zamawiać oddzielnie, patrz strona(y) 626, 627-629

Uwaga: Waga podana bez wkładki

Części zamienne, zawarte w dostawie

Dla	Śruba mocująca	Klucz (Typu flaga)	Klucz (Typu T)	Klucz	Śruba mocująca
C3-391.0780-30	19TB04075	03M03C	-	-	950L0608
C4-391.0780-40	19TB04075	03M03C	-	-	950L0612
C5-391.0780-50	950D0410	03M03C	-	-	950L0616
C6-391.0780-60	950D0612	-	DOUBLE-T	H6B-H5.0L	950L0616
C8-391.0780-70	950D0616	-	DOUBLE-T	H6B-H5.0L	950L1030

Aksesoria

Dla	Klucz dynamometryczny do śrub mocujących
C3-391.0780-30	H00-3030
C4-391.0780-40	H00-3030
C5-391.0780-50	H00-3030
C6-391.0780-60	H00T-50100
C8-391.0780-70	H00T-50100

FB780 Libraflex® z możliwością wyważania

Graflex®

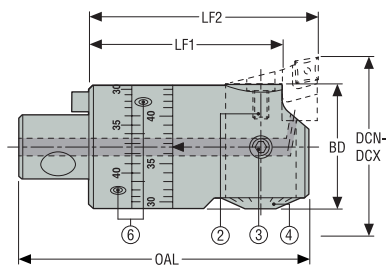

- 6. Śruba mocująca 2
- 2. Śruba montażowa
- 3. Śruba mocująca 1
- 4. Mikrometryczna śruba regulacyjna



- Z regulacją mikrometryczną (skok 0,01 mm i noniusz 2,5 µm, na średnicy)
- Wyważanie jest realizowane poprzez ustawienie obu pierścieni zgodnie ze średnicą wytaczanego otworu.
- Prędkości V_c do 1 495 m/min i więcej, patrz strony 630

Numer produktu	Oznaczenie	Wielk. Graflex	Od strony detalu		Zakres DCN-DCX Ø	OAL	LF1	LF2	BD	Waga	Oprawka
			mm	mm							
00055932	A79020	G2	30,0 1.181	40,0 1.575	59,5 2.343	37,5 1.476	45,0 1.772	27,0 1.063	0,19 0.420	20	
00056005	A79030	G3	39,0 1.535	51,0 2.008	82,0 3.228	54,5 2.146	65,0 2.559	35,0 1.378	0,45 0.990	30	
00056006	A79040	G4	50,0 1.969	65,0 2.559	93,0 3.661	61,5 2.421	72,0 2.835	43,0 1.693	0,78 1.720	40	
00056007	A79050	G5	64,0 2.520	86,0 3.386	109,0 4.291	71,5 2.815	82,0 3.228	54,0 2.126	1,42 3.130	50	
00001451	A79060	G6	85,0 3.346	115,0 4.528	140,0 5.512	88,5 3.484	105,0 4.134	70,0 2.756	2,87 6.330	60	

Wkładki należy zamawiać oddzielnie, patrz strona(y) 626, 627-629
Uwaga: Waga podana bez wkładki

Części zamienne, zawarte w dostawie

Do głowicy	Śruba mocująca	Klucz (Typu T)	Klucz	Śruba mocująca 1	Śruba mocująca 2	Zabierak
A79020	19TB0305	DOUBLE-T	H4B-H2.0	950L0406	960D30045S	90M2
A79030	19TB04075	-	03M03C	950L0608	AU7901030	90M3
A79040	19TB04075	-	03M03C	950L0612	AU7901040	90M4
A79050	950D0410	-	03M03C	950L0616	AU7901050	90M51
A79060	950D0612	DOUBLE-T	H6B-H5.0L	950L1016	AU7901060	90M6

Akcesoria

Do głowicy	Klucz dynamometryczny do śruby blokującej pierścieni wyważający	Klucz dynamometryczny do śrub mocujących
A79020	H00-2009	-
A79030	H00-3020	H00-3030
A79040	H00-3020	H00-3030
A79050	H00-3020	H00-3030
A79060	H00T-5050	H00T-50100

FB 620 GL – Główce do wytaczania precyzyjnego

kompaktowy, z połączeniem GL

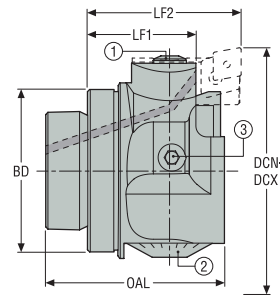

- Przeznaczony do wytaczaków GL25, GL32, GL40 i GL50 Steadyline®
- Wewnętrzne podawanie chłodziwa w kierunku krawędzi skrawającej
- Z regulacją mikrometryczną (skok 0,01 mm i noniusz 2,5 µm, na średnicy)

1. Śruba montażowa
2. Mikrometryczna śruba regulacyjna
3. Śruba mocująca

Oznaczenie	Numer produktu	Wielk. GL	Od strony detalu Zakres DCN-DCX Ø		OAL	LF1	LF2	BD	Waga	Maks. obroty**
			mm	mm						
GL25-FB620-10	03307855	GL25	27,0 1.063	35,0 1.378	29,5 1.161	17,7 0.697	28,0 1.102	25,0 0.984	0,2 0.440	9000
GL32-0620-20	02904469	GL32	34,0 1.339	46,0 1.811	35,2 1.386	23,75 0.935	32,1 1.264	32,0 1.260	0,13 0.290	7000
GL40-0620-30	02904470	GL40	42,0 1.654	56,0 2.205	40,7 1.602	24,75 0.974	35,1 1.382	40,0 1.575	0,22 0.490	5600
GL50-0620-40	02904471	GL50	52,0 2.047	69,0 2.717	43,7 1.720	25,75 1.014	36,1 1.421	50,0 1.969	0,32 0.710	4800

Wkładki należy zamawiać oddzielnie, patrz strona(y) 626, 627-629

** Dodatkowe informacje na temat maksymalnej prędkości obrotowej, można znaleźć na stronach z instrukcjami.

Uwaga: Waga podana bez wkładki

Części zamienne, zawarte w dostawie

Do głowicy	Śruba mocująca	Klucz mocujący	Klucz (Typu T)	Śruba mocująca
GL25-FB620-10	19TB0305	H2.0-2D	–	19A71000
GL32-FB620-20	19TB0305	H4B-H2.0	DOUBLE-T	950L0406
GL40-FB620-30	19TB04075	03M03C	–	950L0608
GL50-FB620-40	19TB04075	03M03C	–	950L0608

Akcesoria

Do głowicy	Klucz dynamometryczny do śrub mocujących
GL25-FB620-10	–
GL32-FB620-20	H00-2009
GL40-FB620-30	H00-3030
GL50-FB620-40	H00-3030

Wstęp

Wiercenie

Rozwiercanie

Wytaczanie

Załącznik

FB 620 BA – Głowice do wytaczania precyzyjnego

z połączeniem BA

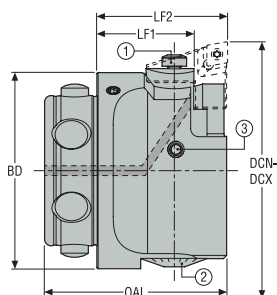

1. Śruba montażowa
2. Mikrometryczna śruba regulacyjna
3. Śruba mocująca

- Przeznaczony do wytaczaków BA60, GL32, GL40 i BA80 Steadyline®
- Wewnętrzne podawanie chłodziwa w kierunku krawędzi skrawającej
- Z regulacją mikrometryczną (skok 0,01 mm i noniusz 2,5 µm, na średnicy)



Oznaczenie	Numer produktu	Wielk. BA	Od strony detalu Zakres DCN-DCX Ø		OAL	LF1	LF2	BD	Waga	Maks. obroty**
			mm	mm						
BA060-FB620-50	03204094	BA060	65,0 2.559	87,0 3.425	55,7 2.193	29,7 1.169	40,0 1.575	60,0 2.362	0,7 1.540	4000
BA080-FB620-60	03204095	BA080	85,0 3.346	115,0 4.528	58,2 2.291	26,7 1.051	41,2 1.622	80,0 3.150	1,1 2.430	3000

Wkładki należy zamawiać oddzielnie, patrz strona(y) 583

** Dodatkowe informacje na temat maksymalnej prędkości obrotowej, można znaleźć na stronach z instrukcjami.

Uwaga: Waga podana bez wkładki

Części zamienne, zawarte w dostawie

Do głowicy	Śruba mocująca	Klucz (Typu flaga)	Klucz (Typu T)	Klucz	Śruba mocująca
BA060-FB620-50	19TB04075	03M03C	-	-	950L0608
BA080-FB620-60	950D0514	-	DOUBLE-T	H6B-H5.0L	950L0608

Wkładki na płytki

Głowice do wytaczania precyzyjnego FB 620 / 780 / 790

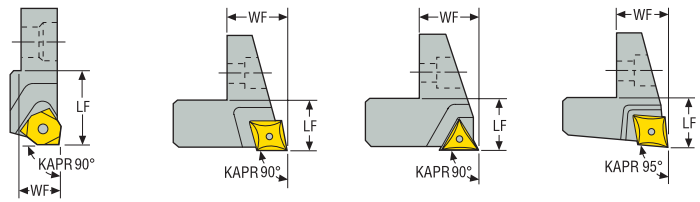

- Odpowiednie do promieniowych głowic do wytaczania FB 620/ 780/ 790
- **Dokładne wyważenie głowic FB A790 nie jest możliwe przy użyciu dużych wkładek.

Oznaczenie	Numer produktu	Typ wkładki	Zakres DCN-DCX Ø		LF	WF	Waga	Do głowicy	KRINS°	**	Oprawka	Odpowiednia wielkość płytki	Konstrukcja
			mm Cal.	mm Cal.									
A78209	00056634	90° dla płytek WB	15,0 0.591	23,5 0.925	7,2 0.283	4,0 0.157	0,1 0.220	FB 78008 / FB 78009	90	-	09	WB...0301...	A
A72510	00056580	90° dla płytek CC	23,0 0.906	31,0 1.220	10,3 0.406	4,5 0.177	0,1 0.220	FB 78010 / FB62010	90	-	10	CC...0602...	B
A72520	00056581	90° dla płytek CC	30,0 1.181	46,0 1.811	8,3 0.327	5,0 0.197	0,1 0.220	FB 78020 / FB 79020 / FB 62020	90	-	20	CC...0602...	B
A72530	00056582	90° dla płytek CC	39,0 1.535	56,0 2.205	10,3 0.406	8,0 0.315	0,1 0.220	FB 78030 / FB 79030 / FB 62030	90	-	30	CC...0602...	B
A72540	00056583	90° dla płytek CC	50,0 1.969	69,0 2.717	10,3 0.406	9,5 0.374	0,1 0.220	FB 78040 / FB 79040 / FB 62040	90	-	40	CC...0602...	B
A72550	00056584	90° dla płytek CC	64,0 2.520	86,0 3.386	10,3 0.406	12,5 0.492	0,1 0.220	FB 78050 / FB 79050 / FB 62050	90	-	50	CC...0602...	B
A7256A	02689978	90° dla płytek CC	85,0 3.346	115,0 4.528	14,5 0.571	18,5 0.728	0,05 0.110	BA080-FB620-60	90	-	6A	CC...09T3...	B
A72560	00056585	90° dla płytek CC	85,0 3.346	115,0 4.528	16,5 0.650	18,9 0.744	0,2 0.440	FB 78060 / FB 79060 / FB 731S500	90	-	60	CC...09T3...	B
A72565	00056587	90° dla płytek CC	114,0 4.488	144,0 5.669	16,5 0.650	33,7 1.327	0,2 0.440	FB 78060 / FB 79060 / FB 731S500	90	**	65	CC...09T3...	B
A72570	00056588	90° dla płytek CC	114,0 4.488	160,0 6.299	16,5 0.650	18,9 0.744	0,09 0.200	FB 78070	90	-	70	CC...09T3...	B
A72575	00056589	90° dla płytek CC	159,0 6.260	205,0 8.071	16,5 0.650	41,7 1.642	0,2 0.440	FB 78070	90	-	75	CC...09T3...	B
A72430	00056572	90° dla płytek TC	39,0 1.535	56,0 2.205	10,3 0.406	7,9 0.311	0,01 0.020	FB 78030 / FB 79030 / FB 62030	90	-	30	TC...1102...	C
A72440	00056573	90° dla płytek TC	50,0 1.969	69,0 2.717	10,3 0.406	9,4 0.370	0,02 0.040	FB 78040 / FB 79040 / FB 62040	90	-	40	TC...1102...	C
A72450	00056574	90° dla płytek TC	64,0 2.520	86,0 3.386	10,3 0.406	12,4 0.488	0,02 0.040	FB 78050 / FB 79050 / FB 62050	90	-	50	TC...1102...	C
A72460	00056575	90° dla płytek TC	85,0 3.346	115,0 4.528	16,3 0.642	18,9 0.744	0,08 0.180	FB 78060 / FB 79060 / FB 731S500	90	-	60	TC...1102...	C
A72465	00056577	90° dla płytek TC	114,0 4.488	144,0 5.669	16,5 0.650	33,7 1.327	0,09 0.200	FB 78060 / FB 79060 / FB 731S500	90	**	65	TC...1102...	C
A72470	00056578	90° dla płytek TC	114,0 4.488	160,0 6.299	16,3 0.642	18,9 0.744	0,1 0.220	FB 78070	90	-	70	TC...1102...	C
A72475	00056579	90° dla płytek TC	159,0 6.260	205,0 8.071	16,5 0.650	41,7 1.642	0,2 0.440	FB 78070	90	-	75	TC...1102...	C
A72610	00056590	95° dla płytek CC	23,0 0.906	31,0 1.220	10,3 0.406	4,5 0.177	0,1 0.220	FB 78010	95	-	10	CC...0602...	D
A72620	00056591	95° dla płytek CC	30,0 1.181	46,0 1.811	8,3 0.327	5,0 0.197	0,1 0.220	FB 78020 / FB 79020 / FB 62020	95	-	20	CC...0602...	D
A72630	00056592	95° dla płytek CC	39,0 1.535	56,0 2.205	10,3 0.406	8,0 0.315	0,1 0.220	FB 78030 / FB 79030 / FB 62030	95	-	30	CC...0602...	D
A72640	00056593	95° dla płytek CC	50,0 1.969	69,0 2.717	10,3 0.406	9,5 0.374	0,02 0.040	FB 78040 / FB 79040 / FB 62040	95	-	40	CC...0602...	D

Wstęp

Wfrczenie



Rozwiercanie

Wytaczanie

Załącznik

Oznaczenie	Numer produktu	Typ wkładki	Zakres DCN-DCX Ø		LF	WF	Waga	Do głowicy	KRINS°	**	Oprawka	Odpowiednia wielkość płytki	Konstrukcja
			mm Cal.	mm Cal.									
A72650	00056594	95° dla płytek CC	64,0 2.520	86,0 3.386	10,3 0.406	12,5 0.492	0,1 0.220	FB 78050 / FB 79050 / FB 62050	95	-	50	CC...0602...	D
A72660	00056595	95° dla płytek CC	85,0 3.346	115,0 4.528	16,5 0.650	18,9 0.744	0,2 0.440	FB 78060 / FB 79060 / FB 731S500	95	-	60	CC...09T3...	D
A72665	00056597	95° dla płytek CC	114,0 4.488	144,0 5.669	16,5 0.650	33,7 1.327	0,09 0.200	FB 78060 / FB 79060 / FB 731S500	95	**	65	CC...09T3...	D
A72670	00056598	95° dla płytek CC	114,0 4.488	160,0 6.299	16,5 0.650	18,9 0.744	0,09 0.200	FB 78070	95	-	70	CC...09T3...	D
A72675	00056599	95° dla płytek CC	159,0 6.260	205,0 8.071	16,5 0.650	41,7 1.642	0,12 0.260	FB 78070	95	-	75	CC...09T3...	D

Części zamienne, zawarte w dostawie

Dla płytki o wielkości	Klucz do płytki	Śruba do płytki	Klucz (Typu T)
			
WB...0301...	H4B-T06P	C02035-T06P	DOUBLE-T
CC...0602...	H4B-T07P	C02504-T07P	DOUBLE-T
CC...09T3...	H4B-T15P	C04008-T15P	DOUBLE-T
TC...1102...	H4B-T07P	C02504-T07P	DOUBLE-T

Wkładki fazujące

Główce do wytaczania precyzyjnego FB 620 / 780 / 790

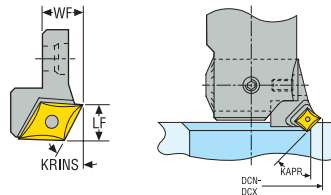

- Odpowiednie do promieniowych głowic do wytaczania FB 620/ 780/ 790

Numer produktu	Oznaczenie	Do głowicy	Oprawka	Zakres DCN-DCX \varnothing		LF	WF	Waga	KRINS°	Odpowiednia wielkość płytki
				mm Cal.	mm Cal.					
00086885	A72910CC0630	FB 78010	10	23,0 0.906	31,0 1.220	10,8 0.425	4,5 0.177	0,01 0.020	30	CC...0602...
00086888	A72920CC0630	FB 78020 / FB 79020/ GL32-0620-20	20	30,0 1.181	36,0 1.417	10,0 0.394	4,9 0.193	0,01 0.020	30	CC...0602...
00086891	A72930CC0630	FB 78030 / FB 79030 / FB 62030	30	39,0 1.535	56,0 2.205	10,5 0.413	8,1 0.319	0,01 0.020	30	CC...0602...
00086894	A72940CC0630	FB 78040 / FB 79040 / FB 62040	40	50,0 1.969	69,0 2.717	10,5 0.413	9,5 0.374	0,02 0.040	30	CC...0602...
00086897	A72950CC0630	FB 78050 / FB 79050	50	64,0 2.520	86,0 3.386	10,5 0.413	12,5 0.492	0,02 0.040	30	CC...0602...
00086900	A72960CC0930	FB 78060 / FB 79060 / A731S500	60	85,0 3.346	115,0 4.528	16,5 0.650	19,1 0.752	0,08 0.180	30	CC...09T3...
00086903	A72970CC0930	FB 78070	70	114,0 4.488	160,0 6.299	16,4 0.646	18,8 0.740	0,09 0.200	30	CC...09T3...
00086886	A72910CC0645	FB 78010	10	23,0 0.906	31,0 1.220	11,5 0.453	4,5 0.177	0,01 0.020	45	CC...0602...
00086889	A72920CC0645	FB 78020 / FB 79020 / FB 62020	20	30,0 1.181	46,0 1.811	10,0 0.394	5,0 0.197	0,01 0.020	45	CC...0602...
00086892	A72930CC0645	FB 78030 / FB 79030 / FB 62030	30	39,0 1.535	56,0 2.205	10,5 0.413	8,1 0.319	0,01 0.020	45	CC...0602...
00086895	A72940CC0645	FB 78040 / FB 79040 / FB 62040	40	50,0 1.969	69,0 2.717	10,5 0.413	9,5 0.374	0,02 0.040	45	CC...0602...
00086898	A72950CC0645	FB 78050 / FB 79050	50	64,0 2.520	86,0 3.386	10,3 0.406	12,4 0.488	0,02 0.040	45	CC...0602...
00086901	A72960CC0945	FB 78060 / FB 79060 / A731S500	60	85,0 3.346	115,0 4.528	16,5 0.650	19,1 0.752	0,07 0.150	45	CC...09T3...
00086904	A72970CC0945	FB 78070	70	114,0 4.488	160,0 6.299	16,4 0.646	18,8 0.740	0,09 0.200	45	CC...09T3...

Zapasowe śruby do płytek i klucze — patrz strona(y) 662

** Dla zakresu DC z belkami i belkami Jumbo, patrz strona 638

Części zamienne, zawarte w dostawie

Dla płytki o wielkości	Klucz do płytki	Śruba do płytki	Klucz (Typu T)
CC...0602...	H4B-T07P	C02504-T07P	DOUBLE-T
CC...09T3...	H4B-T15P	C04008-T15P	DOUBLE-T

Wkładki do wytaczania wstęcznego

Głowice do wytaczania precyzyjnego FB 620 / 780 / 790

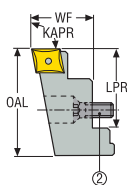
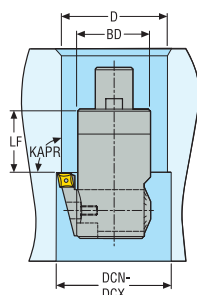

- Odpowiednie do promieniowych głowic do wytaczania FB 620/ 780/ 790
- Dokładne wyważenie głowic FB 790 nie jest możliwe przy użyciu dużych wkładek.
- KRINS 90°
- Odpowiednia wielkość płytki: CC...0602...

Oznaczenie	Numer produktu	Do głowicy	Zakres wytaczania wstęcznego DCN-DCX Ø		LF	BD	OAL	LPR	WF	Waga						
			mm	(Cal.)							mm (Cal.)	mm (Cal.)				
A789X10CC0690	00086907	A78010	39,5-47,5	(1.555-1.870)	16,5	(0.650)	21,5	(0.846)	30,5	(1.201)	16,0	(0.630)	12,8	(0.504)	0,01	(0.020)
		A78020 & A79020	46-56	(1.811-2.205)	21,5	(0.846)	27	(1.063)								
		GL32-0620-20	49,7-61,7	(1.957-2.429)	7,75	(0.305)	32	(1.260)								
A789X30CC0690	00086910	A78030 & A79030	53-65	(2.087-2.559)	32	(1.260)	35	(1.378)	30,0	(1.181)	23,0	(0.906)	15,0	(0.591)	0,03	(0.070)
		A78040 & A79040	61-76	(2.402-2.992)	39	(1.535)	43	(1.693)								
		A78050 & A79050	69-91	(2.717-3.583)	49	(1.929)	54	(2.126)								
		GL40-0620-30	57,6-70,2	(2.268-2.764)	1,75	(0.069)	40	(1.575)								
		GL50-0620-40	67,6-80,2	(2.661-3.157)	2,75	(0.108)	50	(1.969)								
A789X60CC0690	00086909	A78060 & A79060	89-119 *	(3.504-4.685 *)	50	(1.969)	70	(1.969)	50,0	(1.969)	38,5	(1.516)	21,0	(0.827)	0,09	(0.200)
A789X70CC0690	00086911	A78070	118-164	(4.646-6.457)	60	(2.362)	95	(2.362)	50,0	(1.969)	38,5	(1.516)	21,0	(0.827)	0,1	(0.220)

* Dla zakresu DC wytaczania wstęcznego z belkami i belkami Jumbo, patrz strona 642

Zapassowe śruby do płytek i klucze — patrz strona(y) 662

Zawartość dostawy opravek do wytaczania dokładnego zawiera specjalną śrubę zaciskową uchwytu płytki, która ma być użyta zamiast standardowej śruby zaciskowej dostarczonej z głowicami.

DCN/DCX mini = $D+BD / 2 + 0,5 \text{ mm}$ (0.02") od średnicy 39,5 do 47,5 (1.555" do 1.870")

DCB/DCX mini = $D+BD / 2 + 1 \text{ mm}$ (0.039") od średnicy 46 do 64 (1.811" do 2.520")

Części zamienne, zawarte w dostawie

Dł	Śruba mocująca	Śruba do płytki	Klucz (Typu T)	Klucz
A789X10CC0690	950F0308	C02504-T07P	DOUBLE-T	H4B-T07P
A789X30CC0690	950F0410	C02504-T07P	DOUBLE-T	H4B-T07P
A789X60CC0690	-	C02504-T07P	DOUBLE-T	H4B-T07P
A789X70CC0690	-	C02504-T07P	DOUBLE-T	H4B-T07P

Głowice do dokładnego wytaczania FB 780/790 — instrukcje

Zalecane warunki obróbki

Więcej informacji można znaleźć w instrukcjach dostarczanych z głowicami oraz oprawkami GL.

Maksymalne prędkości głowic do wytaczania precyzyjnego typu promieniowego

Maksymalne prędkości przedstawione na stronach produktów głowic do wytaczania dotyczą samej konstrukcji mechanicznej oraz jakości wyważenia głowicy. Zastosowana prędkość powinna także uwzględniać inne warunki pracy np. obrabiany materiał, płytkę, długość narzędzia, wrzeciono obrabiarki.

Podczas wytaczania z użyciem oprawki Steadyline®, nie można przekroczyć maksymalnych obrotów oprawki: Patrz instrukcje dostarczone razem z oprawką Steadyline®.

Poniższa tabela z maksymalnymi obrotami dotyczy głowicy wyposażonej we wkładki do wytaczania lub fazowania. W przypadku gdy używamy wkładek do wytaczania wstecznego z głowicą FB 620, FB 790 lub FB 780, użyj maksymalnych obrotów dla A780.. o podobnej wielkości.

Wielkość głowicy	Zakres \varnothing mm (cale)	Maks. obr./min.	Domniemana maks. prędkość skrawania V_c przy min. zakresie m/min (stp/min)	Domniemana maks. prędkość skrawania V_c przy maks. zakresie m/min (stp/min)
Głowice do wytaczania precyzyjnego FB 620 z połączeniami po stronie maszyny GL i BA do toczenia i wytaczania z tłumikiem drgań Steadyline®				
GL25-FB620-10	27-35 (1.063-1.378)	9000	760 (2493)	1000 (3281)
GL32-FB620-20	34-46 (1.339-1.811)	7000	748 (2454)	1012 (3320)
GL32-FB620-30	42-56 (1.654-2.205)	5600	739 (2425)	985 (3232)
GL32-FB620-40	52-69 (2.047-2.717)	4800	784 (2572)	1040 (3412)
BA060-FB620-50	66-88 (2.598-3.465)	4000	830 (2723)	1105 (3625)
BA080-FB620-60	86-116 (3.386-4.567)	3000	810 (2657)	1093 (3586)
FB 790 głowice do wytaczania precyzyjnego, z możliwością wyważenia, mocowanie Graflex®				
A79020	30-40 (1.181-1.575)	16000	1508 (4948)	2011 (6598)
A79030	39-51 (1.535-2.008)	12250	1501 (4925)	1963 (6440)
A79040	50-65 (1.969-2.559)	10000	1571 (5154)	2042 (6699)
A79050	64-86 (2.520-3.386)	7500	1508 (4948)	2026 (6647)
A79060	85-115 (3.346-4.528)	5600	1495 (4905)	2023 (6637)
FB 780 głowice do wytaczania precyzyjnego, mocowanie Graflex®				
A78008	15-18,5 (0.591-0.728)	16000	754 (2474)	930 (3051)
A78009	18-23,5 (0.709-0.925)	13000	735 (2411)	960 (3150)
A78010	23-31 (0.906-1.220)	10000	723 (2372)	974 (3196)
A78020	30-40 (1.181-1.575)	8000	754 (2474)	1005 (3297)
A78030	39-51 (1.535-2.008)	6000	735 (2411)	961 (3153)
A78040	50-65 (1.969-2.559)	5000	785 (2575)	1021 (3350)
A78050	64-86 (2.520-3.386)	3700	744 (2441)	1000 (3281)
A78060	85-115 (3.346-4.528)	2700	721 (2365)	975 (3199)
	114-144 (4.488-5.669)	2200	788 (2585)	995 (3264)
A78070	114-160 (4.488-6.299)	2000	716 (2349)	1005 (3297)
	159-205 (6.260-8.071)	1600	799 (2621)	1030 (3379)
FB 780 głowice do wytaczania precyzyjnego, mocowanie Seco-Capto™				
C3-391.0780-30	39-51 (1.535-2.008)	6000	735 (2411)	961 (3153)
C4-391.0780-40	50-65 (1.969-2.559)	5000	785 (2575)	1021 (3350)
C5-391.0780-50	64-86 (2.520-3.386)	3700	744 (2441)	1000 (3281)
C6-391.0780-60	85-115 (3.346-4.528)	2700	721 (2365)	975 (3199)
	114-144 (4.488-5.669)	2200	788 (2585)	995 (3264)
C8-391.0780-70	114-160 (4.488-6.299)	2000	716 (2349)	1005 (3297)
	159-205 (6.260-8.071)	1600	799 (2621)	1030 (3379)

Uwaga: Maksymalne prędkości są uzależnione od mechanicznej konstrukcji głowicy oraz jakości wyważenia. Prędkość z podanego zakresu należy wybrać uwzględniając warunki obróbki takie jak, obrabiany materiał, krawędź skrawająca (płytkę), długość wystawienia, wrzeciono obrabiarki. Od prędkości 8000 obr. i powyżej, oprawka podstawowa i przedłużki powinny być wyważone dokładnie.



Belki

Seco oferuje pełną gamę belek standardowych i typu Jumbo do operacji wytaczania i obtaczania dużych średnic.

- Zaprojektowane z myślą o maksymalnej uniwersalności belki są dostępne w szerokiej gamie średnic jako produkty standardowe, obejmujące zakres średnic 204–655 mm (8.03–25.78 cala)
- Belki Seco Jumbo są wykonane z wytrzymałego aluminium ze stalowymi interfejsami i obejmują zakres średnic 654–2155 mm (25.75 – 84.843 cala)

Ogólny opis

Wstęp

Wiercenie

Rozwiercanie

Wytaczanie

Załącznik

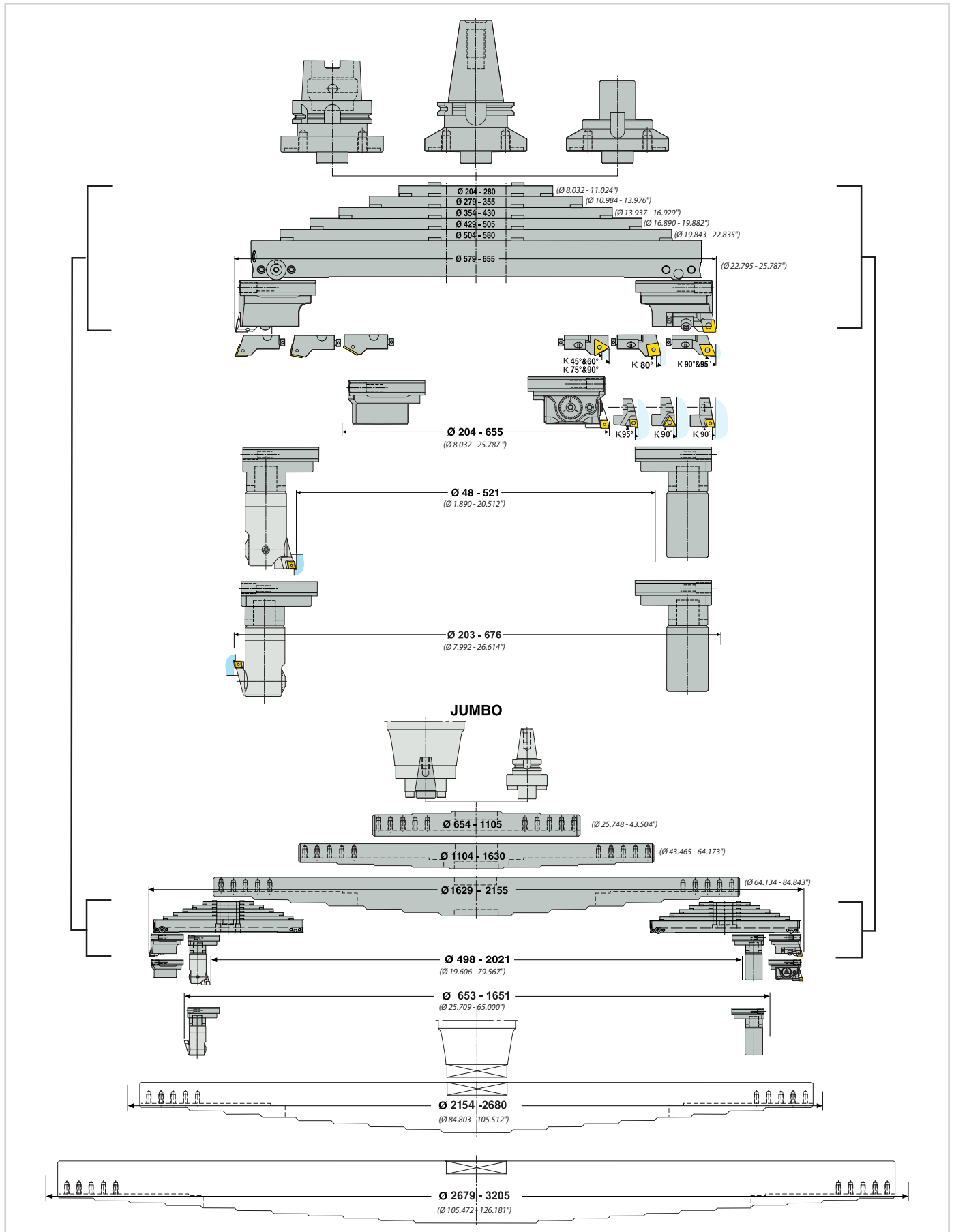

Właściwości

5 belek do wytaczania

Ø 654–3205 mm (Ø 25.748–126.181"), także toczenie średnic zewnętrznych Ø 498–3071 mm (Ø 19.606–120.906") i wytaczanie wsteczne Ø 653–3226 mm (Ø 25.709–127.008").

Belki Jumbo wykonane w wytrzymałego aluminium ze stalowymi wkładkami, przeznaczone do mocowania kilku standardowych belek w kilku pozycjach.

Wielkości A731S001, 002, 003 dostarczane są z 4 śrubami mocującymi do zamocowania w oprawce frezarskiej, typ 569 montaż na kołnierzu, średnica Ø 60 mm (Ø 2.362") - lub bezpośrednio do wrzeciona (DIN 2079/50), wyposażonego w trzpień centrujący. Belki Jumbo są dostarczane z dwoma uchwyłami do podnoszenia.

Wielkości A731S004-...* i A731S005-...* są dostępne na zamówienie, z możliwością montażu wrzecion standardowych lub specjalnych, zależnie od obrabiarki:

Zakres Ø mm (cale)	Oznaczenie	Wymiary w mm (calach), patrz rysunek na stronie produktu							Waga
		DCB	LF	HTB	LB	CBDP	WB	DCON	
2154-2680 (84.803-105.512")	A731S004-...*	*	70 (2.75591")	300 (11.811")	160 (6.29921")	*	2140 (84.25197")	*	*
2679-3205 (105.472-126.181")	A731S005-...*	*	110 (4.33071")	400 (15.748")	200 (7.87402")	*	2665 (104.9213")	*	*

* oznaczenie i wymiary będą kompletne po uwzględnieniu typu mocowania wrzeciona.

Główne cechy belek Jumbo

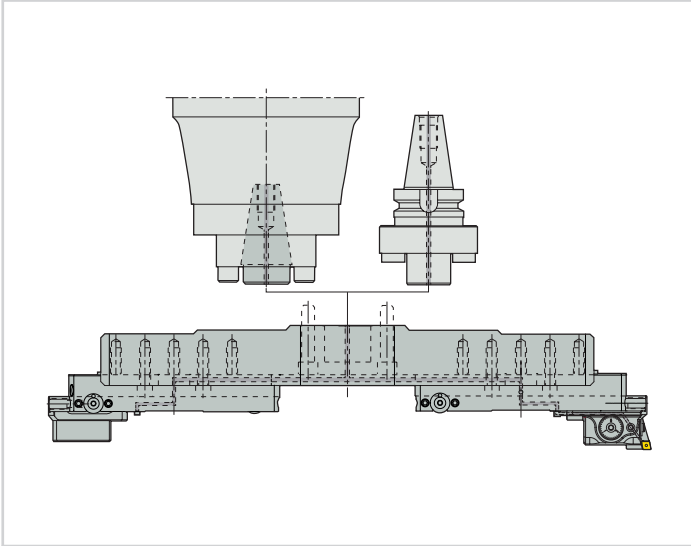

Belki Jumbo 'S' są wyposażone w kanały doprowadzające chłodziwo od oprawki lub kołnierza do dwóch standardowych belek oraz dodatkową śrubę zabezpieczającą standardowe belki.

Uwaga! Nowe belki Jumbo 'S' mogą mocować klasyczne belki (nowe oznaczone 'S', lub poprzedni model): w przypadku mocowania poprzedniego modelu, nie można zastosować dodatkowej śruby. Doprowadzenie chłodziwa do ostrza jest możliwe tylko w przypadku belki Jumbo 'S' oraz standardowych belek 'S'. W celu zachowania wyważenia, nie stosować starych oraz nowych belek i bloków na tej samej belce Jumbo jednocześnie.

Właściwości

6 belek do wytaczania

Ø 204–655 mm (Ø 8.032–25.787") także toczenie średnic zewnętrznych Ø 48–521 mm (Ø 1.890–20.512") i wytaczanie wsteczne.

Belki są wyposażone w połączenie po stronie obrabiarki Ø 130 mm (Ø 5.118") do bezpośredniego mocowania na oprawkach do belek (SA i HSK) lub na adapterach Graflex®.

W przypadku stosowania adaptera Graflex® można użyć przedłużeń lub mocowania do wrzeciona, patrz system modułowy Graflex®. Ustawienie kątowne belki wytaczarskiej co 30° w oprawce lub adapterze Graflex®, w celu wygodnego przechowywania w magazynie.

Belki mogą być wyposażone w bloki Graflex® do obróbki zgrubnej, dokładnej lub przeciwwagi.

Bloki wytaczarskie są mocowane na belce za pomocą dwóch cylindrów poruszanych przez trzy śruby. Jedna śruba wyposażona jest w dysk ograniczający skok przesuwu bloku wewnątrz zakresu oraz ograniczający ruch bloku poza belkę. Precyzyjny i stopniowy przesuw bloku w celu regulacji średnicy, skok na promieniu 38 mm (Ø 1.496") przy użyciu śruby regulacyjnej połączonej z kółkiem belki.

Przepływ chłodziwa przez belkę oraz bloki w kierunku krawędzi skrawającej.

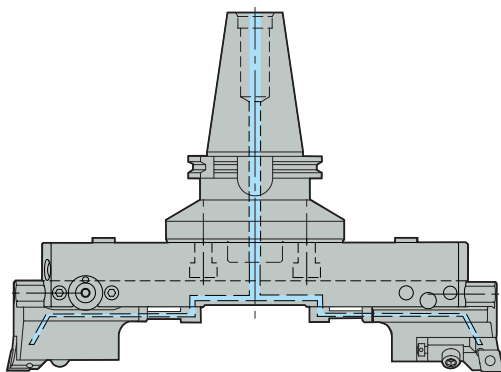

Celem wybrania belki standardowej oraz Jumbo do wytaczania, obtaczania lub wytaczania wstecznego odpowiedniej średnicy, patrz tablica doboru belek, str. 637-642.

Maksymalne obroty, patrz str. 648.

Uwaga! Nowe belki (oznaczenie A731S 0_0) nie posiadają możliwości mocowania poprzednich bloków (oznaczenie A731 _00 -bez S-).

Właściwości

Blok do wytaczania zgrubnego

Duży dwustronny zespół z belką do wytaczania zgrubnego, jest wyposażony w dwa bloki, każdy z nich posiada odpowiednie wkładki. Blok do wytaczania zgrubnego doprowadza chłodziwo do krawędzi.

W przypadku stosowania adaptera Graflex® można użyć przedłużeń lub mocowania do wrzeciona, patrz system modułowy Graflex®.

Ustawienie katowe belki wytaczarskiej co 30° w oprawce lub adapterze Graflex®, w celu wygodnego przechowywania w magazynie.

Belki mogą być wyposażone w bloki Graflex® do obróbki zgrubnej, dokładnej lub przeciwwagi.

Wkładki

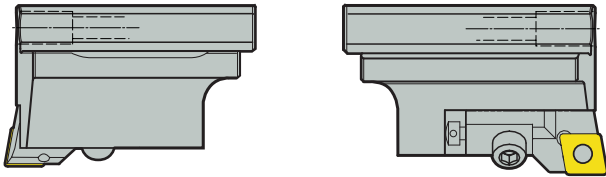

Dostępne w bardzo szerokim asortymencie:

- Wkładki o kącie przystawienia 90°, zalecane w większości zastosowań do wytaczania w celu zmniejszenia zużycia energii.
- Wkładki o kącie przystawienia 80°, zalecane do wytaczania otworów przelotowych (i fazowania), szczególnie w żeliwie, aby uniknąć pęknięć przy wyjściu. Większe zapotrzebowanie na moc.
- Wymagane są inne wkładki z mocowaniem ISO5611/h1 = 16 mm (0.629").

UWAGA! Obie wkładki mogą być wyregulowane na tę samą średnicę lub w pozycji niesymetrycznej. Podkładka wkładki dostępna w akcesoriach (oznaczenie 18LS0316). Montaż i ustawianie, patrz str. 637-642.

Blok i przeciwwaga do wytaczania na gotowo

Zespół z belką do dokładnego wytaczania składa się z jednego bloku do dokładnego wytaczania i przeciwwagi.

Mechanizm regulacji średnicy w bloku do dokładnego wytaczania z mikrometryczną śrubą regulacyjną (1 skok = 5 μm (197 μcal) na średnicy). System regulacji jest zabezpieczony i nasmarowany na cały okres eksploatacji.

Precyzja mechanizmu zapewnia powtarzalność. Śruba regulacyjna znajduje się z boku bloku, co umożliwia łatwy dostęp.

Blok do wytaczania na gotowo doprowadza chłodziwo do krawędzi.

Odpowiednie wkładki na płytki do wytaczania precyzyjnego A72460, A72560 lub A72660

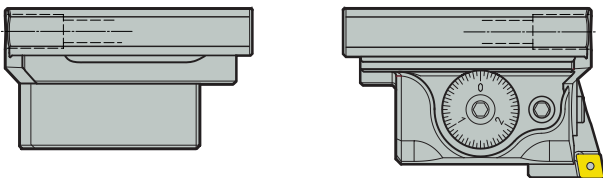

Odpowiednie wkładki płytek do dokładnego wytaczania A72460, A72560 lub A72660 należy zamawiać oddzielnie: są to takie same wkładki jak dla głowic wykańczających, patrz str. 626, 627.

Montaż i ustawianie, patrz str. 637-642.

Właściwości

Bloki wytaczarskie Graflex® do obtaczania i wytaczania wstecznego

Ten blok posiada żeńskie gniazdo Graflex® wielkość G5.

Każda głowica Graflex®, narzędzie specjalne lub standardowy moduł Graflex® G5 mogą być montowane na belkach wytaczarskich, patrz rysunek pokazujący obtaczanie średnicy zewnętrznej lub wytaczanie wsteczne przy użyciu 2 bloków Graflex® z głowicą do wytaczania na gotowo Graflex® A78050 z wkładką (np. A72550) lub wkładką (e.g. A789X30CC0690) i przeciwwagą Graflex® (np. BM050W78050).

Możliwe są dwie pozycje modułu Graflex® na bloku dzięki dwóm zestawom dwóch śrub z kulistym zakończeniem oraz dwóm wypustom ustawionym pod kątem 180°. Blok i głowica do wytaczania doprowadzają chłodziwo do krawędzi.

Montaż i ustawianie, patrz str. 637-642.

Bloki wytaczarskie Graflex® do obtaczania i wytaczania wstecznego

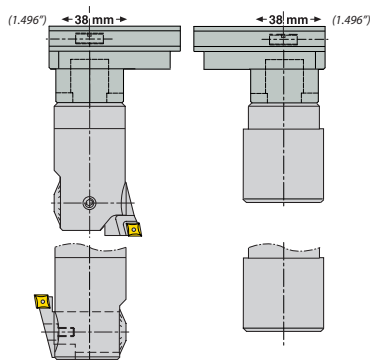

Nowe bloki wytaczarskie (oznaczenie A731S 400, A731S 500, A731S 600, A731S 40128) mogą być także montowane na starych belkach (oznaczenie A731 0_0 -bez S-).

Montaż i maks. obroty patrz instrukcje do oferowanych jeszcze poprzednich belek.

Nie stosować starych i nowych bloków na tej samej belce.

UWAGA! Nowe bloki także mogą być montowane na starych belkach.

Porada dotycząca doboru akcesoriów doprowadzających chłodziwo

Obróbka zgrubna (belka z 2 blokami):

Celem doprowadzenia chłodziwa bezpośrednio na obie krawędzie skrawające, użyj 2 przewodów (oznaczenie AU731S00700), zamocowanych na belce, oraz 2 zestawów dysz (oznaczenie AU731S40700), zamocowanych na blokach. Standardowe doprowadzenie chłodziwa z otworu w bloku, to 2 przewody (oznaczenie AU731S00700), zamocowane na belce.

Wytaczanie na gotowo (belka z 1 blokiem do wytaczania na gotowo i 1 przeciwwagą):

Zastosować 1 przewód łączący (oznaczenie AU731S00700), zamocowany na belce i połączony z blokiem wytaczarskim. Bloki do wytaczania na gotowo oryginalne są wyposażone w dyszę kierującą chłodziwo bezpośrednio na ostrze. Obtaczanie średnicy (np. belka z 2 blokami Graflex® wyposażonymi w głowicę i przeciwwagę): Zastosować 1 przewód łączący (oznaczenie AU731S00700), zamocowany na belce i połączony z blokiem wytaczarskim Graflex® oraz głowicą. Wewnętrzny otwór bloku Graflex® doprowadzi chłodziwo do zamocowanej głowicy.



Przewód łączący
(oznaczenie AU731S00700)

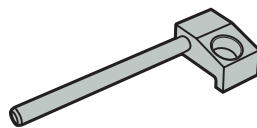

Zestaw dysz
(oznaczenie AU731S40700)

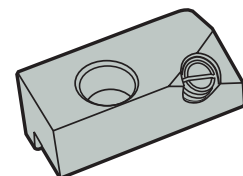

UWAGA! Dopuszczalne ciśnienie chłodziwa = 70 bar maks.

Składanie zespołu do wytaczania

Zespół do wytaczania zgrubnego do $\varnothing 655 \text{ mm}$ ($\varnothing 25.787''$) wymaga: 1 belkę (A731S 0_0) + 2 bloki zgrubne (2x A731S 400) z wkładkami*.

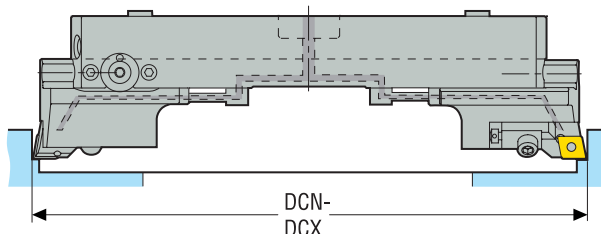

Rys. 1

Zespół do wytaczania wykańczającego do $\varnothing 655 \text{ mm}$ ($\varnothing 25.787''$) wymaga: 1 belkę (A731S 0_0) + 1 blok wykańczający (A731S 500) z wkładką na płytce wielkość 60** + 1 blok przeciwwagi (A731S 600).

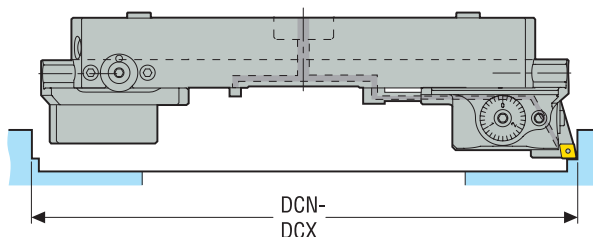

Rys. 2

Zespół do wytaczania zgrubnego do $\varnothing 3205 \text{ mm}$ ($\varnothing 126.181''$) wymaga: 1 belkę Jumbo (A731S 00_) + 2 belki (A731S 0_0) + 2 bloki zgrubne (2x A731S 400) i 2 wkładki*.

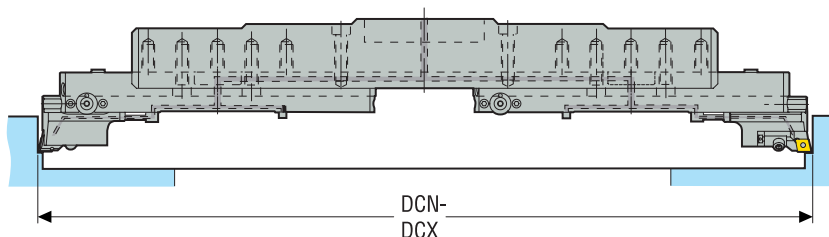

Rys. 3

Zespół do wytaczania wykańczającego do $\varnothing 3205 \text{ mm}$ ($\varnothing 126.181''$) wymaga: 1 belkę Jumbo (A731S 00_) + 2 belki (A731S 0_0) + 1 blok wykańczający (A731S 500) z wkładką na płytce wielkość 60** + 1 blok przeciwwagi (A731S 600).

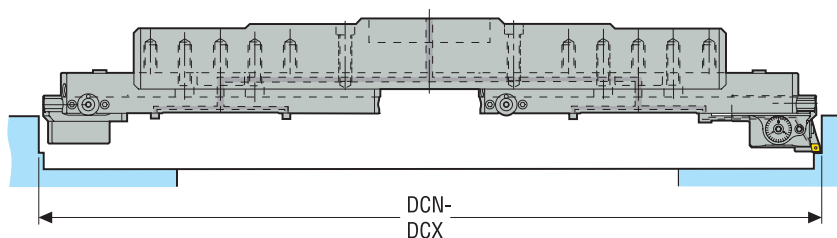

Rys. 4

* Kasety zamawiać osobno.
* Wkładki należy zamówić oddzielnie.

Składanie zespołu do wytaczania:
Tabela wyboru belek w celu zbudowania wymaganej średnicy WYTACZANIA

Do wytaczania DCN-DCX Ø mm	Do wytaczania DCN-DCX Ø cal.	Belka Jumbo	Klasyczne belki	Do wytaczania zgrubnego		Do wytaczania na gotowo						
					Rys.		Rys.					
204-280	8.031-11.024	-	A731S 010	2x A731S 400 + 2 wkładki	1	A731S 500 + 1 Wkładki na płytce + A731S 600	2					
279-355	10.984-13.976	-	A731S 020									
354-430	13.937-16.929	-	A731S 030									
429-505	16.890-19.882	-	A731S 040									
504-580	19.843-22.835	-	A731S 050									
579-655	22.795-25.787	-	A731S 060									
654-805	25.748-31.693	A731S 001	2x A731S 010	2x A731S 400 + 2 wkładki	3	A731S 500 + 1 Wkładki na płytce + A731S 600	4					
654-880	25.748-34.646		2x A731S 020									
804-955	31.654-37.598		2x A731S 030									
879-1030	34.606-40.551		2x A731S 040									
1029-1105	40.512-43.504		2x A731S 050									
1104-1255	43.465-49.409	A731S 002	2x A731S 010	2x A731S 400 + 2 wkładki	3	A731S 500 + 1 Wkładki na płytce + A731S 600	4					
1104-1330	43.465-52.362		2x A731S 020									
1179-1405	46.417-55.315		2x A731S 030									
1254-1480	49.370-58.268		2x A731S 040									
1329-1555	52.323-61.220		2x A731S 050									
1404-1630	55.276-64.173		2x A731S 060									
1629-1780	64.134-70.079		2x A731S 010									
1629-1855	64.134-73.031	2x A731S 020	2x A731S 400 + 2 wkładki	3	A731S 500 + 1 Wkładki na płytce + A731S 600	4						
1704-1930	67.087-75.984	2x A731S 030										
1779-2005	70.039-78.937	2x A731S 040										
1854-2080	72.992-81.890	2x A731S 050										
1929-2155	75.945-84.843	2x A731S 060										
2154-2305	84.803-90.748	A731S 003	2x A731S 010	2x A731S 400 + 2 wkładki	3	A731S 500 + 1 Wkładki na płytce + A731S 600	4					
2154-2380	84.803-93.701		2x A731S 020									
2229-2455	87.756-96.654		2x A731S 030									
2304-2530	90.709-99.606		2x A731S 040									
2379-2605	93.661-105.512		2x A731S 050									
2454-2680	96.614-105.512		2x A731S 060									
2679-2830	105.472-111.417	A731S 004	2x A731S 010	2x A731S 400 + 2 wkładki	3	A731S 500 + 1 Wkładki na płytce + A731S 600	4					
2679-2905	105.472-114.370		2x A731S 020									
2754-2980	108.425-117.323		2x A731S 030									
2829-3055	111.378-120.276		2x A731S 040									
2904-3130	114.331-123.228		2x A731S 050									
2979-3205	117.283-126.181		2x A731S 060									
2679-2905	105.472-114.370		A731S 005					2x A731S 010	2x A731S 400 + 2 wkładki	3	A731S 500 + 1 Wkładki na płytce + A731S 600	4
2754-2980	108.425-117.323							2x A731S 020				
2829-3055	111.378-120.276	2x A731S 030										
2904-3130	114.331-123.228	2x A731S 040										
2979-3205	117.283-126.181	2x A731S 050										
		2x A731S 060										
		2x A731S 060										

Wstęp

Wiercenie

Rozwiercanie

Wytaczanie

Załącznik

Składanie zespołu do obtaczania:

Zespół do toczenia średnic zewnętrznych do $\varnothing 521$ mm ($\varnothing 20.512''$) wymaga: 1 belkę (A731S 0_0) + 2 bloki Graflex® (2x A731S 40128) + np. 1 głowicę wykańczającą (A780 50) z 1 wkładką wielkość 60° + 1 przeciwwagę (BM050W78050).

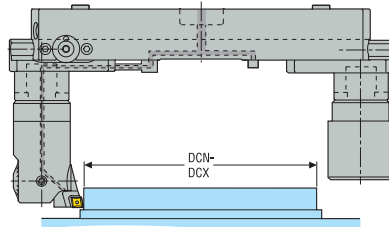

Rys. 1

Zespół do wytaczania zgrubnego do $\varnothing 3205$ mm ($\varnothing 120.906''$) wymaga: 1 belkę Jumbo (A731S 00_) + 2 belki (A731S 0_0) + 2 bloki zgrubne (2x A731S 400) i 2 wkładki*.

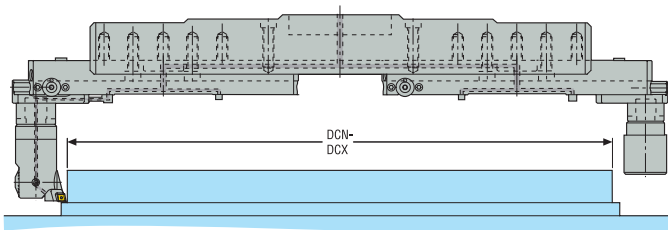

Rys. 2

* Wkładki należy zamówić oddzielnie.

Składanie zespołu do obtaczania:
Tabela wyboru belek w celu zbudowania wymaganej średnicy OBTACZANIA

Do obtaczania średnicy DCN-DCX Ø mm	Do obtaczania średnicy DCN-DCX Ø cal.	Belka Jumbo	Klasyczne belki	Do obtaczania średnicy zewnętrznej na gotowo	Rys.
48-146	1.890-5.748	-	A731S 010	2x A731S 40128 + 1x A780 50 + 1 Wkładki na płytce + 1x BM050W78050	1
123-221	4.843-8.701	-	A731S 020		
198-296	7.795-11.654	-	A731S 030		
273-371	10.748-14.606	-	A731S 040		
348-446	13.701-17.559	-	A731S 050		
423-521	16.654-20.512	-	A731S 060		
498-671	19.606-26.417	A731S 001	2x A731S 010	2x A731S 40128 + 1x A780 50 + 1 Wkładki na płytce + 1x BM050W78050	2
498-746	19.606-29.370		2x A731S 020		
648-821	25.512-32.323		2x A731S 030		
723-896	28.465-35.276		2x A731S 040		
873-971	34.370-38.228		2x A731S 050		
948-1121	37.323-44.134	A731S 002	2x A731S 010	2x A731S 40128 + 1x A780 50 + 1 Wkładki na płytce + 1x BM050W78050	2
948-1196	37.323-47.087		2x A731S 020		
1098-1271	43.228-50.039		2x A731S 030		
1173-1346	46.181-52.992		2x A731S 040		
1323-1421	52.087-55.945		2x A731S 050		
1398-1496	55.039-58.898		2x A731S 060		
1473-1646	57.992-64.803		2x A731S 010		
1473-1721	57.992-67.756	2x A731S 020			
1623-1796	63.898-70.709	2x A731S 030			
1698-1871	66.850-73.661	2x A731S 040			
1848-1946	72.756-76.614	2x A731S 050			
1923-2021	75.709-79.567	A731S 003	2x A731S 060	2x A731S 40128 + 1x A780 50 + 1 Wkładki na płytce + 1x BM050W78050	2
1998-2171	78.661-85.472		2x A731S 010		
1998-2246	78.661-88.425		2x A731S 020		
2148-2321	84.567-91.378		2x A731S 030		
2223-2396	87.520-94.331		2x A731S 040		
2373-2471	93.425-97.283		2x A731S 050		
2448-2546	96.378-100.236	A731S 004	2x A731S 060	2x A731S 40128 + 1x A780 50 + 1 Wkładki na płytce + 1x BM050W78050	2
2523-2696	99.331-106.142		2x A731S 010		
2523-2771	99.331-109.094		2x A731S 020		
2973-2846	117.047-112.047		2x A731S 030		
2748-2921	108.189-115.000		2x A731S 040		
2898-2996	114.094-117.953	2x A731S 050			
2973-3071	117.047-120.906	2x A731S 060			

Wstęp

Wiercenie

Rozwiercanie

Wytaczanie

Załącznik

Składanie zespołu do wytaczania wstecznego:

Zespół do wytaczania wstecznego wykańczającego do $\varnothing 676$ mm ($\varnothing 26.614$ ") wymaga: 1 belkę (A731S 0_0) + 2 bloki Graflex® (2x A731S 40128) + np. 1 głowicę wykańczającą (A780 50) z 1 wkładką wsteczną wielkość 50° + 1 przeciwwagę (BM050W78050).

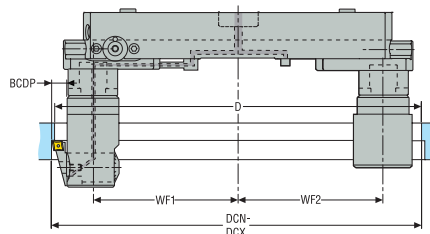

Rys. 1

Zespół do wytaczania wstecznego wykańczającego do $\varnothing 3226$ mm ($\varnothing 127.008$ ") wymaga: 1 belkę Jumbo (A731S 00_) + 2 belki (A731S 0_0) + np. 1 głowicę wykańczającą (A780 50) z 1 wkładką na płytce wielkość 50° + 1 przeciwwagę (BM050W78050).

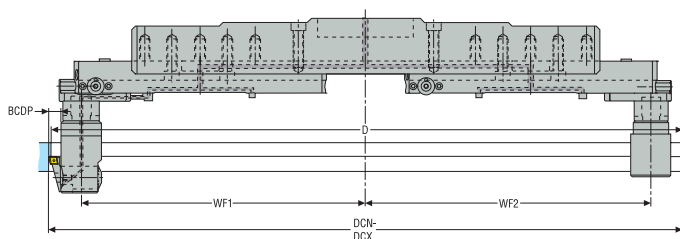

Rys. 2

* Wkładki należy zamówić oddzielnie.

Wyznaczanie minimalnej dostępnej średnicy (D min)

Warunki wyważenia: $WF1 = WF2$

$D_{min} = DC + 5 - BCDP$

BCDP = odległość pomiędzy krawędzią płytki a korpusem głowicy A78050 ($7,5 < BCDP < 18,5$).

Dwa ekstremalne przypadki:

Głowica A78050 ustawiona na minimalną średnicę: $D_{min} = DCN - 2,5$

Głowica A78050 ustawiona na maksymalną średnicę: $D_{min} = DCX - 13,5$

Składanie zespołu do wytaczania wstecznego: Tabela wyboru belek w celu zbudowania wymaganej średnicy WYTACZANIA WSTECZ- NEGO

Do wytaczania wstecznego DCN-DCX Ø mm	Do wytaczania wstecznego DCN-DCX Ø cal.	Belka Jumbo	Klasyczne belki	Do wytaczania wstecznego na gotowo	Rys.
203-301	7.992-11.850	-	A731S 010	2x A731S 40128 + 1x A780 50 + 1 wkładki do wytaczania wstecznego + 1x BM050W78050	1
278-376	10.945-14.803	-	A731S 020		
353-451	13.898-17.756	-	A731S 030		
428-526	16.850-20.709	-	A731S 040		
503-601	19.803-23.661	-	A731S 050		
578-676	22.756-26.614	-	A731S 060		
653-826	25.709-32.520	A731S 001	2x A731S 010	2x A731S 40128 + 1x A780 50 + 1 wkładki do wytaczania wstecznego + 1x BM050W78050	2
653-901	25.709-35.472		2x A731S 020		
803-976	31.614-38.425		2x A731S 030		
878-1051	34.567-41.378		2x A731S 040		
1028-1126	40.472-44.331		2x A731S 050		
1103-1276	43.425-50.236	A731S 002	2x A731S 010	2x A731S 40128 + 1x A780 50 + 1 wkładki do wytaczania wstecznego + 1x BM050W78050	2
1103-1351	43.425-53.189		2x A731S 020		
1253-1426	49.331-56.142		2x A731S 030		
1328-1501	52.283-59.094		2x A731S 040		
1478-1576	58.189-62.047		2x A731S 050		
1553-1651	61.142-65.000		2x A731S 060		
1628-1801	64.094-70.906		2x A731S 010		
1628-1876	64.094-73.858	2x A731S 020			
1778-1951	70.000-76.811	2x A731S 030			
1853-2026	72.953-79.764	2x A731S 040			
2003-2101	78.858-82.717	2x A731S 050			
2078-2176	81.811-85.669	2x A731S 060			
2153-2326	84.764-91.575	A731S 004	2x A731S 010	2x A731S 40128 + 1x A780 50 + 1 wkładki do wytaczania wstecznego + 1x BM050W78050	2
2153-2401	84.764-94.528		2x A731S 020		
2303-2476	90.669-97.480		2x A731S 030		
2378-2551	93.622-100.433		2x A731S 040		
2528-2626	99.528-103.386		2x A731S 050		
2603-2701	102.480-106.339		2x A731S 060		
2678-2851	105.433-112.244		2x A731S 010		
2678-2926	105.433-115.197	2x A731S 020			
2828-3001	111.339-118.150	2x A731S 030			
2903-3076	114.291-121.102	2x A731S 040			
3053-3151	120.197-124.055	2x A731S 050			
3128-3226	123.150-127.008	2x A731S 060			

Wstęp

Wiercenie

Rozwiercanie

Wytaczanie

Załącznik

ABB 731 200 – Oprawki i adaptory do belek wytaczarskich

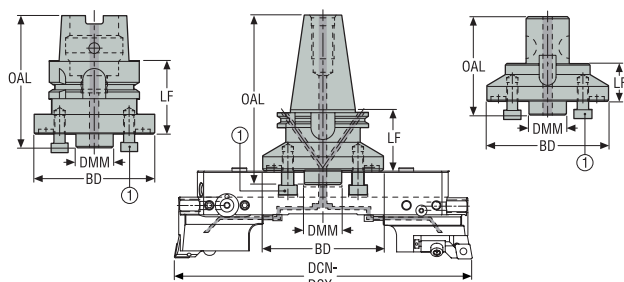

1. Śruba regulacyjna

- Oprawki HSK i SA do krótkich złożeń
- Adapter Graflex® do rozszerzonych zestawów
- Pozycja kątowna belki co 30°
- Dostarczana z pierścieniem uszczelniającym o'ring $\varnothing 58 \times 3$ mm



Oznaczenie	Numer produktu	Oprawka	Wielkość	Od strony detalu		Zakres DCN-DCX \varnothing	OAL	LF	BD	DMM	Waga
				mm	mm						
E3471731200	02503392	DIN 69871-ADB	DIN50 ADB	204,0 8.031	655,0 25.787		166,75 6.565	65,0 2.559	130,0 5.118	40,0 1.575	5,74 12.650
E3416731200	02503393	BT JIS B 6339-ADB	BT50 ADB	204,0 8.031	655,0 25.787		166,75 6.565	65,0 2.559	130,0 5.118	40,0 1.575	5,64 12.430
E9306731200	02417268	ISO 12164-1/ DIN69893-A	HSK-A100	204,0 8.031	655,0 25.787		115,0 4.528	65,0 2.559	130,0 5.118	40,0 1.575	4,72 10.410
A731200	00056616	GRAFLEX	G7	204,0 8.031	655,0 25.787		90,0 3.543	40,0 1.575	130,0 5.118	40,0 1.575	3,78 8.330

Części zamienne, zawarte w dostawie

Dla	Śruba mocująca	Klucz	Śruba uszczelniająca	Zabierak
E3471731200	950D1230	10SMS795	950A0606	-
E3416731200	950D1230	10SMS795	950A0606	-
E9306731200	950D1230	10SMS795	-	-
A731200	950D1230	10SMS795	-	90M7

Akcesoria

Dla	Przewód do chłodziwa	Zaślepki uszczelniające	Klucz
E3471731200	-	-	-
E3416731200	-	-	-
E9306731200	20E9306	02E9306	03E9306
A731200	-	-	-

Moment dokręcania 80 Nm. Więcej informacji można znaleźć w instrukcjach dostarczanych z belkami oraz blokami.

Akcesoria, należy zamawiać osobno

BB 731S0x0 – Belki wytaczarskie

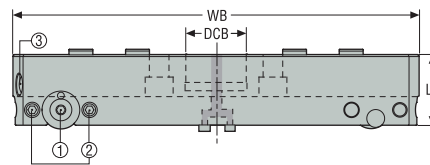
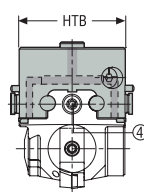

- Chłodzenie przez belkę

1. Śruba blokująca z tarczą oporową
2. Śruba mocująca
3. Sworzeń mocujący
4. Śruba regulacyjna średnicy

Oznaczenie	Numer produktu	Od strony detalu Zakres DCN-DCX Ø		HTB	WB	DCB	LF	Waga
		mm	mm					
		Cal.	Cal.	Cal.	Cal.	Cal.	Cal.	lbs
A731S010	02753664	204,0 8.031	280,0 11.024	70,0 2.756	195,0 7.677	40,0 1.575	47,0 1.850	3,6 7.940
A731S020	02753668	279,0 10.984	355,0 13.976	70,0 2.756	269,0 10.591	40,0 1.575	47,0 1.850	4,92 10.850
A731S030	02753670	354,0 13.937	430,0 16.929	70,0 2.756	344,0 13.543	40,0 1.575	47,0 1.850	6,4 14.110
A731S040	02753673	429,0 16.890	505,0 19.882	70,0 2.756	419,0 16.496	40,0 1.575	47,0 1.850	7,9 17.420
A731S050	02753675	504,0 19.843	580,0 22.835	70,0 2.756	494,0 19.449	40,0 1.575	47,0 1.850	10,4 22.930
A731S060	02753677	579,0 22.795	655,0 25.787	70,0 2.756	569,0 22.402	40,0 1.575	47,0 1.850	12,3 27.120

Części zamienne, zawarte w dostawie

Dla DCN-DCX	Klucz (Typu T)	Klucz	Klucz mocujący	Śruba mocująca
204-655	DOUBLE-T	H6B-H5.0L	03HL05	19A71060

Moment dokręcania 20 Nm śrub mocujących (2) i śruby mocujące z tarczą oporową (1).

Przed ustawieniem średnicy upewnić się, że sworzeń ustalający jest zazębiony. Więcej informacji można znaleźć w instrukcjach dostarczanych z belkami oraz blokami.

Maksymalne obroty, patrz str. 648 * Zakres średnic obtaczanych, patrz przewodnik str. 639-640

W przypadku większych średnic, patrz belki Jumbo na str. 645

JBB 731S00 – Belki Jumbo

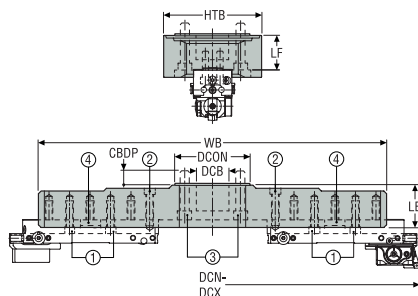

1. Śruba montażowa
2. Śruba mocująca
3. Śruba mocująca
4. Zaślepki uszczelniające

- Belki Jumbo są przeznaczone do mocowania dwóch klasycznych belek w kilku pozycjach
- Belki Jumbo z doprowadzeniem chłodziwa

Oznaczenie	Numer produktu	Od strony detalu Zakres DCN-DCX Ø		HTB	LF	WB	DCON	DCB	CBDP	LB	Waga	**
		mm	mm									
A731S001	02828506	654,0	1105,0	180,0	63,0	640,0	135,0	60,0	24,0	77,0	20,25	-
		25.748	43.504	7.087	2.480	25.197	5.315	2.362	0.945	3.031	44.640	
A731S002	02828516	1104,0	1630,0	200,0	50,0	1090,0	135,0	60,0	24,0	80,0	34,5	-
		43.465	64.173	7.874	1.969	42.913	5.315	2.362	0.945	3.150	76.060	
A731S003	02904383	1629,0	2155,0	200,0	50,0	1615,0	135,0	60,0	24,0	80,0	67,0	**
		64.134	84.843	7.874	1.969	63.583	5.315	2.362	0.945	3.150	147.710	

Wytaczanie, obtaczanie i wytaczanie wsteczne w przypadku kombinacji Jumbo i belek, patrz strony z opisem 637-642

** Większe wielkości A731S004-... (Ø 2154-2680 mm) i A731S005-... (Ø 2679-3205 mm) dostępne na zamówienie, patrz strony z poradnikiem 633

Akcesoria, należy zamawiać osobno

Części zamienne, zawarte w dostawie

Akcesoria

Dla DCN-DCX	Śruba mocująca	Śruba ustalająca	Śruba dźwigni	Śruba mocująca	O-ring	Zaślepki uszczelniające	Trzpień centrujący
654-1105	950D1240	950D1670	90AS03	950D1250	90JT02	AU731S01100	E447153960
1104-1630	950D1240	950D1680	90AS03	950D1250	90JT02	AU731S01100	E447153960
1629-2155	950D1240	950D16120	90AS03	950D1250	90JT02	AU731S01100	E447153960

Zestaw uszczelek O-ring zawiera 6 uszczelek O-ring Ø 6 mm (0.236") do przewodów chłodzących i jedną uszczelkę 1 O-ring Ø 60 mm (2.362") do otworu mocującego belki Jumbo.

BBB 731S0xx – do bloków wytaczarskich i belek Jumbo

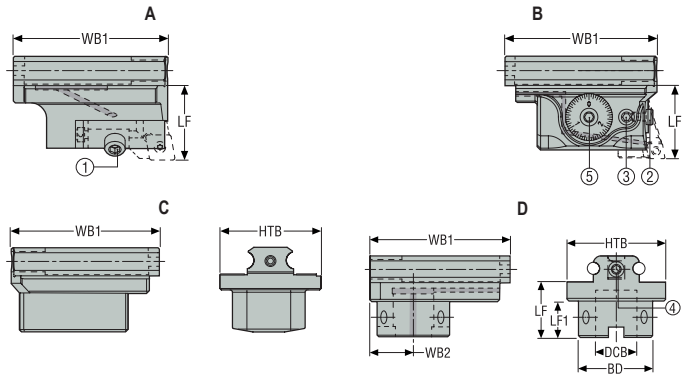

- Do mocowania na belkach
- Chłodziwo doprowadzone przez bloki zgrubne, wykańczające i Graflex

1. Śruba montażowa
5. Mikrometryczna śruba regulacyjna
3. Śruba mocująca

2. Śruba montażowa
4. Śruba regulacyjna średnicy

Numer produktu	Oznaczenie	Typ bloku	Od strony detalu		DCB	BD	WB1	WB2	LF	LF1	HTB	Waga	Konstrukcja
			Zakres DCN-DCX Ø										
			mm	mm	mm	mm	mm	mm	mm	mm	mm	kg	
			Cal.	Cal.	Cal.	Cal.	Cal.	Cal.	Cal.	Cal.	Cal.	lbs	
02753679	A731S400	Blok do wytaczania zgrubnego*	204,0 8.031	2155,0 84.843	-	-	97,0 3.819	-	47,0 1.850	-	70,0 2.756	1,33 2.930	A
02753680	A731S500	Blok do wytaczania na gotowo**	204,0 8.031	2155,0 84.843	-	-	97,0 3.819	-	47,0 1.850	-	70,0 2.756	1,5 3.310	B
02753682	A731S600	Przeciwwaga	204,0 8.031	2155,0 84.843	-	-	97,0 3.819	-	-	-	70,0 2.756	1,49 3.280	C
02753687	A731S40128	Graflex wielkość G5***	48,0 1.890	2021,0 79.567	28,0 1.102	50,0 1.969	97,0 3.819	30,0 1.181	36,0 1.417	25,0 0.984	70,0 2.756	0,98 2.160	D

Części zamienne, zawarte w dostawie

Dla	Śruba mocująca	Śruba mocująca tulejkę	Klucz (Typu T)	Klucz	Klucz mocujący	O-ring
A731S400	950CB0830	-	DOUBLE-T	H6B-H5.0L	-	90JT01
A731S500	950D0612	950L1016	DOUBLE-T	H6B-H5.0L	-	90JT01
A731S600	-	-	DOUBLE-T	H6B-H5.0L	-	-
A731S40128	90F5	-	DOUBLE-T	H6B-H5.0L	03H05	90JT01

* Wkładki należy zamawiać oddzielnie, patrz strona(y) 647

** Wkładki do płytek na gotowo, wielkość 60, zamawiane oddzielnie, patrz strona 626, 627

*** W przypadku stosowania głowicy A78050 należy użyć przeciwwagi BM050W78050, patrz Akcesoria poniżej.

Zestaw uszczelek O-ring zawiera 6 uszczelek O-ring Ø 6 mm (0.236") do przewodów chłodzących i jedną uszczelkę 1 O-ring Ø 60 mm (2.362") do otworu mocującego belki Jumbo.

Akcesoria, należy zamawiać osobno

Akcesoria

Dla	Przewód łączący	Zestaw do chłodziwa	Podkładka	Przeciwwaga
A731S400	AU731S00700	AU731S40700	18LS0316	-
A731S500	AU731S00700	-	-	-
A731S600	-	-	-	-
A731S40128	AU731S00700	-	-	BM050W78050

Wstęp

Wiercenie

Rozwiercanie

Wytaczanie

Załącznik

Wkładki, do bloków do wytaczania zgrubnego dla belek A731S400

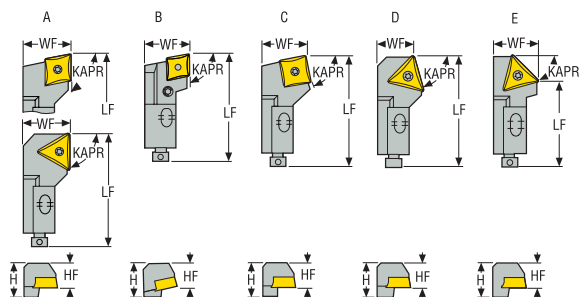

- Do mocowania na bloku do wytaczania zgrubnego

Oznaczenie	Numer produktu	KAPR°	LF	WF	H	HF	Waga	Odpowiednia wielkość płytki	Wersja
			mm Cal.	mm Cal.	mm Cal.	mm Cal.			
SCGCL16CA-16	00039871	90	55,0 2.165	25,0 0.984	20,0 0.787	16,0 0.630	0,2 0.440	CC..16..	A
STGCL16CA-16	00009197	90	63,0 2.480	24,96 0.983	25,0 0.984	16,0 0.630	0,2 0.440	TC..16T3..	A
STGCL16CA-22	02600181	90	55,0 2.165	25,0 0.984	20,0 0.787	16,0 0.630	0,2 0.440	TC..2204..	A
PCGNL16CA-12	02484356	90	63,0 2.480	25,0 0.984	25,0 0.984	16,0 0.630	0,2 0.440	CN..12..	B
SSRCL16CA-15	00039872	75	63,0 2.480	25,0 0.984	20,0 0.787	16,0 0.630	0,2 0.440	SC..15..	C
STRCL16CA-16	00008750	75	63,0 2.480	24,96 0.983	25,0 0.984	16,0 0.630	0,2 0.440	TC..16T3..	D
STRCL16CA-22	02585320	75	63,0 2.480	25,0 0.984	20,0 0.787	16,0 0.630	0,2 0.440	TC..2204..	D
STTCL16CA-16	00009194	60	63,0 2.480	14,96 0.589	25,0 0.984	16,0 0.630	0,2 0.440	TC..16T3..	D
STSCL16CA-16	00009193	45	53,0 2.087	24,96 0.983	25,0 0.984	16,0 0.630	0,2 0.440	TC..16T3..	E

Części zamienne do wkładek, patrz katalog Toczenie MN.

Zalecane warunki obróbki

Najlepsze wyniki uzyskuje się przy doprowadzeniu chłodziwa na ostrze (wyższe parametry, lepsza powierzchnia, lepsze usuwanie wiórów).

Wytaczanie zgrubne zależy priorytetów: czy interesuje nas większy posuw czy więcej usuwanego materiału, wówczas stosujemy ustawienie symetryczne wkładek (najpopularniejsza metoda, możliwość stosowania podwójnego posuwu), lub ustawienie niesymetryczne (podwójna głębokość skrawania).

Podczas wytaczania wykańczającego stali, w dobrych warunkach, zalecamy stosowanie płytek Cermet, dla uzyskania większych prędkości i trwałości.

Szczegółowe instrukcje, patrz informacje dostarczane razem z głowicami wytaczarskimi oraz oprawkami Steadyline®. Instrukcje można także pobrać ze strony www.secotools.com.

Rozwiązywanie problemów

Patrz zalecenia odnośnie wytaczania zgrubnego, str. 575, lub na gotowo str. 615

Maksymalne obroty dla belek wytaczarskich

Z powodu dużych wielkości belek wytaczarskich, zaprogramowanie zbyt dużej wielkości, może spowodować uszkodzenie narzędzia i obrabiarki. Poniższe maksymalne obroty obowiązują dla obecnych belek wytaczarskich A731S 0_0) wraz z blokami do wytaczania zgrubnego, na gotowo i przeciwwagami (A731S _00) oraz belek Jumbo (A731 00_). W przypadku innych zestawów prosimy o kontakt z lokalnym przedstawicielem Seco.

UWAGA! Przy stosowaniu obecnych bloków do wytaczania (oznaczenie A731S 400, A731S 500, A731S 600, A731S 40128) na poprzednich typach belek (oznaczenie A731 0_0 -bez S-), maks. obroty są przyjmowane jak dla poprzednich typów belek. Aby zachować wyważenie, nie należy stosować starych i nowych bloków na tej samej belce.

Głowica zamocowana na	Zakres \varnothing mm (cale)	Maks. obr./min.	Domniemana maks. prędkość skrawania V_c przy min. zakresie m/min (sf/min)	Domniemana maks. prędkość skrawania V_c przy maks. zakresie m/min (sf/min)
Głowice wytaczarskie z belką (z dwoma blokami ustawionymi symetrycznie)				
A731S010	204-280 (8.0315-11.0236")	1600	1025 (3363)	1407 (4616)
A731S020	279-355 (10.9843-13.9764")	1150	1007 (3304)	1282 (4206)
A731S030	354-430 (13.937-16.9291")	900	1000 (3281)	1215 (3986)
A731S040	429-505 (16.8898-19.8819")	750	1010 (3314)	1189 (3901)
A731S050	504-580 (19.8425-22.8346")	650	1029 (3376)	1184 (3885)
A731S060	579-655 (22.7953-25.7874")	550	1000 (3281)	1131 (3711)
Belki Jumbo (z dwoma identycznymi belkami oraz zestawem symetrycznych bloków)				
A731S001	654-1105 (25.748-43.50394")	170	349 (1145)	590 (1936)
A731S002	1104-1630 (43.46457-64.17323")	100	346 (1135)	512 (1680)
A731S003	1629-2155 (64.13386-84.84252")	70	358 (1175)	473 (1552)
A731S004	2154-2680 (84.80315-105.5118")	50	358 (1175)	420 (1378)
A731S005	2679-3205 (105.4724-126.1811")	40	336 (1102)	402 (1319)

Uwaga: Maksymalne prędkości są uzależnione od mechanicznej konstrukcji głowicy oraz jakości wyważenia. Prędkość z podanego zakresu należy wybrać uwzględniając warunki obróbki, np. obrabiany materiał, krawędź skrawająca (płytkę), długość wystawienia, wrzeczono obrabiarki.

Narzędzia do wytaczania wykonywane na zamówienie

Zespół konstrukcyjny Seco posiada duże doświadczenie w projektowaniu specjalnych rozwiązań dla klientów:

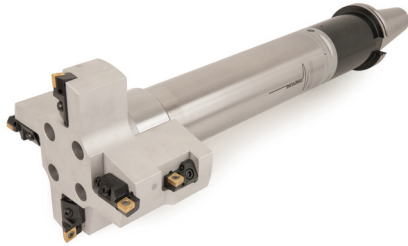

- Steadylite® rozwiązania z tłumieniem drgań do wytaczania zgrubnego i na gotowo,
- Wielostrzowe belki wytaczarskie,
- Specjalne przedłużki z prowadnicami, do operacji z długim wyścięgiem,
- Złożone narzędzia do wiercenia, wytaczania, fazowania, rozwiercania i wykonywania gwintów...

W celu otrzymania dalszych informacji, prosimy kontaktować się z lokalnym przedstawicielem Seco.



Gatunki z pokryciem CVD zalecane do wytaczania

TP1501		<p>Technologia pokrycia Duratomic[®]. Gatunek o dużej odporności na temperaturę oraz ścieranie szczególnie przeznaczony do ogólnej obróbki stali oraz jako alternatywa dla innych materiałów.</p> <p>Ti (C,N) + Al₂O₃.</p>
TP25		<p>Universal grade for high versatile performance over a wide range of applications in steels, stainless steels and cast irons. Trustworthy alternative at limited cutting speeds or high surface finish requirements.</p> <p>Ti(C,N) + Al₂O₃ + Used Edge Detection (Chrome)</p>
TP2501		<p>Technologia pokrycia Duratomic[®]. Odporność na ścieranie oraz wytrzymałość krawędzi razem z dużą uniwersalnością sprawia, iż jest to gatunek dla szerokiego obszaru zastosowań w stali, stali nierdzewnej oraz żeliwie.</p> <p>Ti (C,N) + Al₂O₃.</p>
TP3501		<p>TP3501 jest przeznaczony do obróbki gdzie podstawowym wymaganiem jest ciągliwość i niezawodność przy obróbce stali i stali nierdzewnych.</p> <p>Ti(C,N) + Al₂O₃ DURATOMIC[®]</p>
TP40		<p>TP40 to podstawowy gatunek do toczenia w obszarze P40. Gatunek bardzo ciągliwy używany do szczególnie trudnych operacji toczenia odkuwek, staliwa i wszystkich rodzajów stali nierdzewnych.</p> <p>TiC/Ti(C,N) + TiN</p>
TK0501		<p>Technologia pokrycia Duratomic[®]. Gatunek ekstremalnie odporny na ścieranie do obróbki żeliwa szarego oraz żeliwa ciągliwego.</p> <p>Ti(C,N) + Al₂O₃ + Wykrywanie Użytych Ostrzy (Chrome)</p>
TK1501		<p>Technologia pokrycia Duratomic[®]. Gatunek odporny na ścieranie ogólnie przeznaczony do obróbki żeliwa oraz stali. Gatunek szczególnie przeznaczony do obróbki żeliwa ciągliwego także w trudniejszych warunkach i obróbce przerywanej.</p> <p>Ti(C,N) + Al₂O₃ + Wykrywanie Użytych Ostrzy (Chrome)</p>
TM2501		<p>Gatunek Duratomic[®]. Wydajny gatunek do obróbki austenitycznych stali nierdzewnych zapewniający połączenie odporności na ścieranie i ciągliwości krawędzi. Pierwszy wybór do toczenia austenitycznych stali nierdzewnych. Wybór uzupełniający do toczenia stali w warunkach mocno przerywanych.</p> <p>Ti(C,N) + Al₂O₃ + Wykrywanie Użytych Ostrzy (Chrome)</p>
TH1500		<p>Technologia pokrycia DURATOMIC[®]. Gatunek bardzo twardy i drobnoziarnisty przeznaczony do obróbki części stalowych częściowo hartowanych oraz stanowi alternatywę do obróbki wykańczającej żeliwa.</p> <p>Ti (C,N) + Al₂O₃.</p>
25		<p>Gatunek uniwersalny.</p> <p>Ten gatunek jest przeznaczony do szerokiego zakresu zastosowań przy obróbce stali i stali nierdzewnych oraz żeliwa. Dobre połączenie odporności na ścieranie i ciągliwości.</p> <p>Ti (C, N) + Al</p>

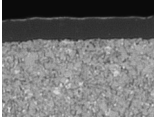
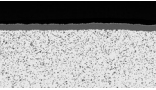
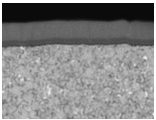
Gatunki z pokryciem PVD zalecane do wytaczania

TS2000		Twardy mikroziarnisty gatunek przeznaczony do obr. wykańczającej superstopów i stopów tytanu. Spisuje się dobrze także przy obróbce wykańczającej stali nierdzewnej. (Ti,Al)N + TiN
CP500 & 26G6		Bardzo ciągliwy mikroziarnisty gatunek przeznaczony do obróbki wykańczającej i średnio-zgrubnej stali nierdzewnej. Bardzo dobrze sprawdza się przy toczeniu przerywanym. CP500 stanowi także alternatywę dla stopów aluminium. (Ti,Al)N + TiN
TH1000		Gatunek bardzo twardy i drobno ziarnisty przeznaczony do elementów stalowych częściowo hartowanych oraz części z superstopów, dzięki doskonałej ciągliwości krawędzi zapewnia doskonałe rezultaty przy obróbce przerywanej.

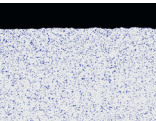
Niepokrywane gatunki zalecane do wytaczania

KX & 03G3		Węgiel drobnoziarnisty przeznaczony do obróbki aluminium i innych materiałów nieżelaznych.
HX		Gatunek uniwersalny niepokrywany przeznaczony do obróbki żeliwa i stali hartowanych, można stosować także do materiałów nieżelaznych.

Cermet zalecany do wytaczania

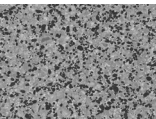
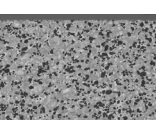
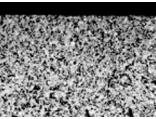
TP1020		Cermet o dużej odporności na ścieranie przeznaczony do uzyskiwania gładkich powierzchni przy obróbce wykańczającej stali i stali nierdzewnych.
TP1030		Cermet pokrywany PVD o dużej odporności na ścieranie przeznaczony do gładkich powierzchni oraz dużej produktywności przy obróbce stali oraz stali nierdzewnych. Pokrycie nanolaminatowe Ti-Al-Si-N.
51G1		Cermet, o bardzo dużej odporności na ścieranie. Przeznaczony do obróbki wykańczającej w stali, gdzie duży nacisk kładzie się na wykończenie powierzchni.

Gatunki CBN i PCD zalecane do wytaczania

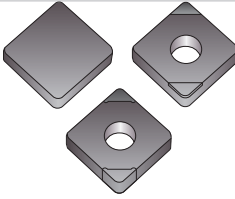
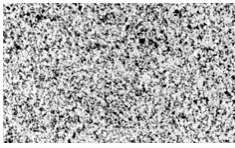
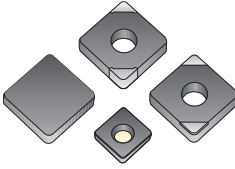
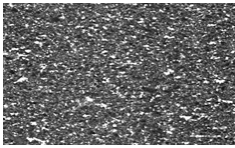
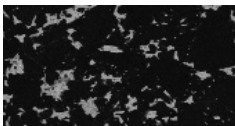
CBN010		<p>Format: Monolityczne, z pełną warstwą lub lutowanymi ostrzami (jedno lub dwustronne). Skład: Gatunek z zawartością CBN 50% o średniej wielkości ziarna 2 μm i o spoiwie ceramicznym TiC. Pokrycie: Brak pokrycia.</p>
CBN10 & 81B1		<p>CBN, gatunek sześciennego azotku boru, do obróbki wykańczającej stali hartowanych (grupa 7) w warunkach stabilnej ciągłej lub lekko przerywanej pracy.</p>
CBN060K		<p>Monolityczne, z lutowanymi ostrzami (jedni i dwustronne) lub pełna warstwa Pierwszy wybór od ciągłej do umiarkowanie przerywanej obróbki stali hartowanej ($a_p < 0.020$ cala). Nowe pokrycie (Ti,Si,Al)N PVD opracowane do obróbki z dużymi prędkościami. Nowe unikatowe spoiwo w postaci superstopu.</p>
CBN200		<p>CBN, gatunek sześciennego azotku boru, do obróbki wykańczając żeliwa perlitycznego, i żelaza spiekanego.</p>
PCD20 & 91J3		<p>PCD, diament polikrystaliczny, do obróbki aluminium i stopów aluminium, miedzi, mosiądzu, brązu i materiałów syntetycznych (Grupy 16-17).</p>

Płytki zalecane do zgrubnego wytaczania, z parametrami

Oznaczenie	Szlifowana pow. przyłożenia i prasowany łamacz			Prasowany łamacz wiórow					Szlifowane krawędzie i łamacz wiórow wersja lewa	Głębokość skrawania, a_p mm (cal.)	Posuw/ząb f mm (cal.)
	KX	HX	03D3	TP2501	TP3501	TP40	25C4	TK1501	CP500		
CPGT050204			02434654							2 (0.079)	0,08-0,2 (0.0031-0.0079)
CCMT060204-F1				02960857	03095430	00008505		03062942	00096854	2 (0.079)	0,1-0,22 (0.0039-0.0087)
CCMT060204-F2		74011732				74018652				2 (0.079)	0,1-0,22 (0.0039-0.0087)
CCGT060204L-UX									02497631	2 (0.079)	0,1-0,22 (0.0039-0.0087)
CCGT060204F-AL	00015710									2 (0.079)	0,1-0,22 (0.0039-0.0087)
CCMT060204-M3				02960858	03095431			03062944		2 (0.079)	0,1-0,22 (0.0039-0.0087)
CCMT09T308-F1				02960861	03095443	00008518		03063857	00096858	2,5 (0.098)	0,1-0,3 (0.0039-0.0118)
CCMT09T308-MF2				02956309	03095446				02754822	2,5 (0.098)	0,1-0,3 (0.0039-0.0118)
CCGT09T304L-UX									02497640	2,5 (0.098)	0,1-0,3 (0.0039-0.0118)
CCGT09T308F-AL	00015754									2,5 (0.098)	0,1-0,3 (0.0039-0.0118)
CCMT120408-F1				02960854	03095449			03062626		4 (0.157)	0,15-0,4 (0.0059-0.0157)
CCMT120408-MF2				02956311	03095452					4 (0.157)	0,15-0,4 (0.0059-0.0157)
CCGT120408L-UX									02610062	4 (0.157)	0,15-0,4 (0.0059-0.0157)
CCGT120408F-AL	00015790									5 (0.197)	0,15-0,4 (0.0059-0.0157)
SCMT060204-M3				02960423	03096621					2,5 (0.098)	0,1-0,22 (0.0039-0.0087)
SCMT09T308-F1				02960396	03096625			03062629	00099708	2,5 (0.098)	0,1-0,3 (0.0039-0.0118)
SCMT09T308-MF2				02956318	03096627				02755042	2,5 (0.098)	0,1-0,3 (0.0039-0.0118)
SCMT120408-F1				02960397	03096630				00099804	4 (0.157)	0,15-0,4 (0.0059-0.0055)
SCMT120408-M3				02960429	03096631			03063990		4 (0.157)	0,15-0,4 (0.0059-0.0055)
TCMT16T308-F1				02960408	03096643	74004572			00091357	5 (0.197)	0,15-0,4 (0.0059-0.0055)
TCMT16T308-MF2				02956323	03096645				02755046	5 (0.197)	0,15-0,4 (0.0059-0.0055)
TCGT16T308F-AL	00015875									4 (0.157)	0,15-0,4 (0.0059-0.0055)
SCMT150512-F2						74007348				7 (0.276)	0,2-0,5 (0.0079-0.0197)

Zalecana prędkości skrawania, patrz str. 658-661

Płytki CN.. zalecane do zgrubnego wytaczania (dwustronne)

Oznaczenie	Prasowany łamacz wiórów				Głębokość skrawania, a _p mm (cal.)	Posuw/ząb f mm (cal.)
	TP3500	TP40	TM2501	TP25		
CNMG120408-M3			03275990	03275989	4,5 (0.177)	0,25-0,35 (0.00984-0.01378)
CNMG120408-MF3		74030598	03275999	03275998	4,5 (0.177)	0,25-0,35 (0.00984-0.01378)
CNMG120408-MF4			03273904		4,5 (0.177)	0,25-0,35 (0.00984-0.01378)
CNMG120408-MF1			03275995		4,5 (0.177)	0,25-0,35 (0.00984-0.01378)
CNMG120408-MR7		74017309	03276001		4,5 (0.177)	0,25-0,35 (0.00984-0.01378)

Zalecane prędkości skrawania, patrz str. 658-661

Płytki zalecane do dokładnego wytaczania, z parametrami

Oznaczenie	Pokrywane							Cermet			Głębokość skrawania, a _p mm (cal.)	Posuw/ząb f mm (cal.)
	TP1501	TS2000	TK1501	CP500	26G6	TH1000	TH1500	51G1	TP1020	TP1030		
CCGT060200								00083915			0,01-0,3 (0.000394-0.01181)	0,03-0,15 (0.0011811-0.0059055)
CCGT0602005-F1				02430287							0,01-0,3 (0.000394-0.01181)	0,03-0,15 (0.0011811-0.0059055)
CCGT060201-F1				02430307							0,01-0,3 (0.000394-0.01181)	0,03-0,15 (0.0011811-0.0059055)
CCGT060202					00039546			00096634			0,01-0,3 (0.000394-0.01181)	0,03-0,15 (0.0011811-0.0059055)
CCGT060204					00081826			00048334			0,01-0,3 (0.000394-0.01181)	0,03-0,15 (0.0011811-0.0059055)
CCGT060204L-UX				02497631							2 (0.079)	0,1-0,22 (0.0039-0.0087)
CCMT060202-F1	02960383	02614299		00096853					02754786	02754435	0,01-0,3 (0.000394-0.01181)	0,03-0,15 (0.0011811-0.0059055)
CCMT060204-F1	02960856	02615873	03062942	00096854		02825858			02754791	02754792	2 (0.079)	0,1-0,22 (0.0039-0.0087)
CCMW060202F-L1											0,01-0,3 (0.000394-0.01181)	0,03-0,15 (0.0011811-0.0059055)
CCMW060204F-L1											0,01-0,3 (0.000394-0.01181)	0,03-0,15 (0.0011811-0.0059055)
CCGW060202S-01020-LF											0,01-0,3 (0.000394-0.01181)	0,03-0,15 (0.0011811-0.0059055)
CCGW060204S-01020-LF											0,01-0,3 (0.000394-0.01181)	0,03-0,15 (0.0011811-0.0059055)
CCGW060204E-L1-B											0,01-0,3 (0.000394-0.01181)	0,03-0,15 (0.0011811-0.0059055)
CCGT09T301-F1				02430311							0,01-0,3 (0.000394-0.01181)	0,03-0,15 (0.0011811-0.0059055)
CCGT09T302					00048337			00048339			0,01-0,3 (0.000394-0.01181)	0,03-0,15 (0.0011811-0.0059055)
CCGT09T304					00077338			00048344			0,01-0,3 (0.000394-0.01181)	0,03-0,15 (0.0011811-0.0059055)
CCGT09T304L-UX				02497640							2,5 (0.098)	0,1-0,3 (0.0039-0.0118)
CCMT09T302-F1	02960837			00096856					02754805	02754806	0,01-0,3 (0.000394-0.01181)	0,03-0,15 (0.0011811-0.0059055)
CCMT09T304-F1	02960844	02615874	03063856	00096857		02731806			02754811	02754812	0,01-0,3 (0.000394-0.01181)	0,03-0,15 (0.0011811-0.0059055)
CCMT09T308-F1	02960853	02615876	03063857	00096858		02731807				02754821	2,5 (0.098)	0,1-0,3 (0.0039-0.0118)
CCMW09T304F-L1											0,01-0,3 (0.000394-0.01181)	0,03-0,15 (0.0011811-0.0059055)
CCMW09T308F-L1											0,01-0,3 (0.000394-0.01181)	0,03-0,15 (0.0011811-0.0059055)
CCGW09T304E-L1-B											0,01-0,3 (0.000394-0.01181)	0,03-0,15 (0.0011811-0.0059055)
CCGW09T308E-L1-B											0,01-0,3 (0.000394-0.01181)	0,03-0,15 (0.0011811-0.0059055)
CCGW09T304S-01020-LF											0,01-0,3 (0.000394-0.01181)	0,03-0,15 (0.0011811-0.0059055)
CCGW09T308S-01020-LF											0,01-0,3 (0.000394-0.01181)	0,03-0,15 (0.0011811-0.0059055)
TCGT110204								00000721			0,01-0,3 (0.000394-0.01181)	0,03-0,15 (0.0011811-0.0059055)
TCGT110201-F1				02430376							0,01-0,3 (0.000394-0.01181)	0,03-0,15 (0.0011811-0.0059055)
TCMT110202-F1				02430419							0,01-0,3 (0.000394-0.01181)	0,03-0,15 (0.0011811-0.0059055)
TCMT110204-F1	02960401			02430421							0,01-0,3 (0.000394-0.01181)	0,03-0,15 (0.0011811-0.0059055)
TCMT110208-F1	02960403			00098986							0,01-0,3 (0.000394-0.01181)	0,03-0,15 (0.0011811-0.0059055)
TCGW110204E-L1-C											0,01-0,3 (0.000394-0.01181)	0,03-0,15 (0.0011811-0.0059055)
TCGW110208E-L1-C											0,01-0,3 (0.000394-0.01181)	0,03-0,15 (0.0011811-0.0059055)
TCGW110204S-01020-LF											0,01-0,3 (0.000394-0.01181)	0,03-0,15 (0.0011811-0.0059055)
TCGW110208S-01020-LF											0,01-0,3 (0.000394-0.01181)	0,03-0,15 (0.0011811-0.0059055)
TCMW110204F-L1											0,01-0,3 (0.000394-0.01181)	0,03-0,15 (0.0011811-0.0059055)
WBG030100								00083089			0,01-0,3 (0.000394-0.01181)	0,03-0,15 (0.0011811-0.0059055)
WBG030102								00091845			0,01-0,3 (0.000394-0.01181)	0,03-0,15 (0.0011811-0.0059055)
WBG030102L				02416632							0,01-0,3 (0.000394-0.01181)	0,03-0,15 (0.0011811-0.0059055)
WBG030102											0,01-0,3 (0.000394-0.01181)	0,03-0,15 (0.0011811-0.0059055)

Tabela jest kontynuowana na następnej stronie.

Zalecana prędkości skrawania, patrz str. 658-661

Wstęp

Wiercenie

Rozwiercanie

Wytaczanie

Załącznik

Płytki zalecane do dokładnego wytaczania, z parametrami

Oznaczenie	CBN				PCD		Głębokość skrawania, a_p mm (cal.)	Posuw/ząb f mm (cal.)
	CBN010	CBN060K	CBN200	81B1	PCD20	91J3		
CCGT060200							0,01-0,3 (0.000394-0.01181)	0,03-0,15 (0.001181-0.0059055)
CCGT0602005-F1							0,01-0,3 (0.000394-0.01181)	0,03-0,15 (0.001181-0.0059055)
CCGT060201-F1							0,01-0,3 (0.000394-0.01181)	0,03-0,15 (0.001181-0.0059055)
CCGT060202							0,01-0,3 (0.000394-0.01181)	0,03-0,15 (0.001181-0.0059055)
CCGT060204							0,01-0,3 (0.000394-0.01181)	0,03-0,15 (0.001181-0.0059055)
CCGT060204L-UX							2 (0.079)	0,1-0,22 (0.0039-0.0087)
CCMT060202-F1							0,01-0,3 (0.000394-0.01181)	0,03-0,15 (0.001181-0.0059055)
CCMT060204-F1							2 (0.079)	0,1-0,22 (0.0039-0.0087)
CCMW060202F-L1					00089760		0,01-0,3 (0.000394-0.01181)	0,03-0,15 (0.001181-0.0059055)
CCMW060204F-L1					0005684		0,01-0,3 (0.000394-0.01181)	0,03-0,15 (0.001181-0.0059055)
CCGW060202S-01020-LF			02464698				0,01-0,3 (0.000394-0.01181)	0,03-0,15 (0.001181-0.0059055)
CCGW060204S-01020-LF	02916281		02464699				0,01-0,3 (0.000394-0.01181)	0,03-0,15 (0.001181-0.0059055)
CCGW060204E-L1-B	02843086	02776337	02649599				0,01-0,3 (0.000394-0.01181)	0,03-0,15 (0.001181-0.0059055)
CCGT09T301-F1							0,01-0,3 (0.000394-0.01181)	0,03-0,15 (0.001181-0.0059055)
CCGT09T302							0,01-0,3 (0.000394-0.01181)	0,03-0,15 (0.001181-0.0059055)
CCGT09T304							0,01-0,3 (0.000394-0.01181)	0,03-0,15 (0.001181-0.0059055)
CCGT09T304L-UX							2,5 (0.098)	0,1-0,3 (0.0039-0.0118)
CCMT09T302-F1							0,01-0,3 (0.000394-0.01181)	0,03-0,15 (0.001181-0.0059055)
CCMT09T304-F1							0,01-0,3 (0.000394-0.01181)	0,03-0,15 (0.001181-0.0059055)
CCMT09T308-F1							2,5 (0.098)	0,1-0,3 (0.0039-0.0118)
CCMW09T304F-L1					0005686		0,01-0,3 (0.000394-0.01181)	0,03-0,15 (0.001181-0.0059055)
CCMW09T308F-L1					00095357		0,01-0,3 (0.000394-0.01181)	0,03-0,15 (0.001181-0.0059055)
CCGW09T304E-L1-B	02843126	02776338	02649607				0,01-0,3 (0.000394-0.01181)	0,03-0,15 (0.001181-0.0059055)
CCGW09T308E-L1-B	02937148		02649608				0,01-0,3 (0.000394-0.01181)	0,03-0,15 (0.001181-0.0059055)
CCGW09T304S-01020-LF	02916282		02464702				0,01-0,3 (0.000394-0.01181)	0,03-0,15 (0.001181-0.0059055)
CCGW09T308S-01020-LF			02464703				0,01-0,3 (0.000394-0.01181)	0,03-0,15 (0.001181-0.0059055)
TCGT110204							0,01-0,3 (0.000394-0.01181)	0,03-0,15 (0.001181-0.0059055)
TCGT110201-F1							0,01-0,3 (0.000394-0.01181)	0,03-0,15 (0.001181-0.0059055)
TCMT110202-F1							0,01-0,3 (0.000394-0.01181)	0,03-0,15 (0.001181-0.0059055)
TCMT110204-F1							0,01-0,3 (0.000394-0.01181)	0,03-0,15 (0.001181-0.0059055)
TCMT110208-F1							0,01-0,3 (0.000394-0.01181)	0,03-0,15 (0.001181-0.0059055)
TCGW110204E-L1-C	02848657	02776346					0,01-0,3 (0.000394-0.01181)	0,03-0,15 (0.001181-0.0059055)
TCGW110208E-L1-C	02848792						0,01-0,3 (0.000394-0.01181)	0,03-0,15 (0.001181-0.0059055)
TCGW110204S-01020-LF			02464742				0,01-0,3 (0.000394-0.01181)	0,03-0,15 (0.001181-0.0059055)
TCGW110208S-01020-LF			02464744				0,01-0,3 (0.000394-0.01181)	0,03-0,15 (0.001181-0.0059055)
TCMW110204F-L1					0005689		0,01-0,3 (0.000394-0.01181)	0,03-0,15 (0.001181-0.0059055)
WBG030100							0,01-0,3 (0.000394-0.01181)	0,03-0,15 (0.001181-0.0059055)
WBG030102							0,01-0,3 (0.000394-0.01181)	0,03-0,15 (0.001181-0.0059055)
WBG030102L							0,01-0,3 (0.000394-0.01181)	0,03-0,15 (0.001181-0.0059055)
WBGW030102				00096761		00096763	0,01-0,3 (0.000394-0.01181)	0,03-0,15 (0.001181-0.0059055)

Zalecana prędkości skrawania, patrz str. 658-661

Zalecane prędkości skrawania dla wytaczania (związane z materiałem obrabianego przedmiotu i gatunkiem płytki) – Metryczne

SMG	v _c (m/min)										
	KX & HX	03	TP40	TP1501	TP2501	TP3501	TK0501	TK1501	TH1000	TH1500	CP500
P1			60-180	60-350	60-250	60-230					80-200
P2			60-180	60-350	60-250	60-230					80-200
P3			60-180	60-350	60-250	60-230					80-200
P4			60-180	60-350	60-250	60-230					80-200
P5			60-150	60-300	60-250	60-230					80-200
P6			60-140	60-300	60-230	60-200					80-180
P7			60-140	60-300	60-230	60-200					80-160
P8			60-120	60-250	60-230	60-200					80-130
P11			60-120	60-300	60-250	60-200					80-180
M1			60-130	100-200	60-200	60-200					60-160
M2			60-130	100-200	60-200	60-200					60-160
M3			60-120	100-180	60-200	60-200					60-150
M4			60-110	100-180	60-190	60-190					60-150
M5			60-110	100-180	60-180	60-180					60-150
K1			60-140	100-250		60-180	60-230	60-230			60-160
K2			60-140	100-250		60-180	60-230	60-230			60-160
K3			60-140	100-250		60-180	60-230	60-230			60-160
K4			60-140	100-250		60-180	60-200	60-200			60-160
K5			60-140	100-250		60-180	60-200	60-200			60-160
K6			60-130	100-250		60-180	60-200	60-200			60-160
K7			60-130	100-250		60-180	60-200	60-200			60-160
N1	150-800	150-800									150-800
N2	150-800	150-800									150-800
N3	150-500	150-500									150-500
N11	150-400	150-400									150-400
S1	20-50	20-50									20-50
S2	20-50	20-50									20-50
S3	20-50	20-50									20-50
S11	20-50	20-50									20-50
S12	20-50	20-50									20-50
S13	20-50	20-50									20-50
H3									50-150	50-150	
H5									50-140	50-140	
H7									50-150	50-150	
H8									30-130	30-130	
H11									30-120	30-120	
H12									30-120	30-120	
H21											
H31											

SMG = Grupy materiałowe Seco v_c = m/min (stp/min) Wszystkie parametry są wartościami początkowymi

Wstęp

Wiercenie

Rozwiercanie

Wytaczanie

Załącznik

Zalecane prędkości skrawania dla wytaczania (związane z materiałem obrabianego przedmiotu i gatunkiem płytki) – *Calowe*

SMG	v_c (stp/min)										
	KX & HX	03	TP40	TP1501	TP2501	TP3501	TK0501	TK1501	TH1000	TH1500	CP500
P1			197-591	197-1148	197-820	197-755					262-656
P2			197-591	197-1148	197-820	197-755					262-656
P3			197-591	197-1148	197-820	197-755					262-656
P4			197-591	197-1148	197-820	197-755					262-656
P5			197-492	197-984	197-820	197-755					262-656
P6			197-459	197-984	197-755	197-656					262-591
P7			197-459	197-984	197-755	197-656					262-525
P8			197-394	197-820	197-755	197-656					262-427
P11			197-394	197-984	197-820	197-656					262-591
M1			197-427	328-656	197-656	197-656					197-525
M2			197-427	328-656	197-656	197-656					197-525
M3			197-394	328-591	197-656	197-656					197-492
M4			197-361	328-591	197-623	197-623					197-492
M5			197-361	328-591	197-591	197-591					197-492
K1			197-459	328-820		197-591	197-755	197-755			197-525
K2			197-459	328-820		197-591	197-755	197-755			197-525
K3			197-459	328-820		197-591	197-755	197-755			197-525
K4			197-459	328-820		197-591	197-656	197-656			197-525
K5			197-459	328-820		197-591	197-656	197-656			197-525
K6			197-427	328-820		197-591	197-656	197-656			197-525
K7			197-427	328-820		197-591	197-656	197-656			197-525
N1	492-2625	492-2625									492-2625
N2	492-2625	492-2625									492-2625
N3	492-1640	492-1640									492-1640
N11	492-1312	492-1312									492-1312
S1	66-164	66-164									66-164
S2	66-164	66-164									66-164
S3	66-164	66-164									66-164
S11	66-164	66-164									66-164
S12	66-164	66-164									66-164
S13	66-164	66-164									66-164
H3								164-492	164-492		
H5								164-459	164-459		
H7								164-492	164-492		
H8								98-427	98-427		
H11								98-394	98-394		
H12								98-394	98-394		
H21											
H31											

SMG = Grupy materiałowe Seco v_c = m/min (stp/min) Wszystkie parametry są wartościami początkowymi

Wstęp

Wiercenie

Rozwiercanie

Wytaczanie

Załącznik

Zalecane prędkości skrawania dla wytaczania (związane z materiałem obrabianego przedmiotu i gatunkiem płytki) – Metryczne

SMG	v _c (m/min)												
	26	25	TS2000	TP1020	TP1030	51	CBN10/ CBN010	81	CBN200	82	PCD20	91	Axiabore
P1	80-200	60-180		100-350	100-350	100-350							80-250
P2	80-200	60-180		100-350	100-350	100-350							80-250
P3	80-200	60-180		100-350	100-350	100-350							80-250
P4	80-200	60-180		100-350	100-350	100-350							80-250
P5	80-200	60-180		100-350	100-350	100-350							70-230
P6	80-180	60-160		100-300	100-300	100-300							70-230
P7	80-160	60-160		100-250	100-250	100-250							70-230
P8	80-130	60-130		100-250	100-250	100-250							70-200
P11	80-180	60-150		100-300	100-300	100-300							70-200
M1	60-160	60-140	60-200	80-200	80-200	80-200							60-200
M2	60-160	60-140	60-200	80-200	80-200	80-200							60-200
M3	60-150	60-130	60-200	80-200	80-200	80-200							60-180
M4	60-150	60-120	60-180	80-180	80-180	80-180							60-170
M5	60-150	60-120	60-180	80-180	80-180	80-180							60-170
K1	60-160	60-160		100-250	100-250	100-250			300-1000	300-1000			60-150
K2	60-160	60-160		100-250	100-250	100-250			300-1000	300-1000			60-150
K3	60-160	60-160		100-250	100-250	100-250			300-1000	300-1000			60-150
K4	60-160	60-160		100-250	100-250	100-250			300-1000	300-1000			60-130
K5	60-160	60-160		100-250	100-250	100-250							50-100
K6	60-160	60-160		100-180	100-180	100-180							50-100
K7	60-160	60-160		100-180	100-180	100-180							50-100
N1	150-800										300-1500	300-1500	200-800
N2	150-800										300-1500	300-1500	200-800
N3	150-500										200-800	200-800	200-800
N11	150-400										180-800	180-800	200-800
S1	20-50		20-80										20-60
S2	20-50		20-80										20-60
S3	20-50		20-80										60-50
S11	20-50		20-80										20-50
S12	20-50		20-80										20-50
S13	20-50		20-80										20-50
H3							80-180	80-180					
H5							80-200	80-200					
H7							80-150	80-150					
H8							80-150	80-150					
H11													
H12													
H21													
H31													

SMG = Grupy materiałowe Seco v_c= m/min (stp/min) Wszystkie parametry są wartościami początkowymi

Wstęp

Wiercenie

Rozwiercanie

Wytaczanie

Załącznik

Zalecane prędkości skrawania dla wytaczania (związane z materiałem obrabianego przedmiotu i gatunkiem płytki) – *Całowe*

SMG	v_c (stp/min)												
	26	25	TS2000	TP1020	TP1030	51	CBN10/ CBN010	81	CBN200	82	PCD20	91	Axiabore
P1	262-656	197-591		328-1148	328-1148	328-1148							262-820
P2	262-656	197-591		328-1148	328-1148	328-1148							262-820
P3	262-656	197-591		328-1148	328-1148	328-1148							262-820
P4	262-656	197-591		328-1148	328-1148	328-1148							262-820
P5	262-656	197-591		328-1148	328-1148	328-1148							230-755
P6	262-591	197-525		328-984	328-984	328-984							230-755
P7	262-525	197-525		328-820	328-820	328-820							230-755
P8	262-427	197-427		328-820	328-820	328-820							230-656
P11	262-591	197-492		328-984	328-984	328-984							230-656
M1	197-525	197-459	197-656	262-656	262-656	262-656							197-656
M2	197-525	197-459	197-656	262-656	262-656	262-656							197-656
M3	197-492	197-427	197-656	262-656	262-656	262-656							197-591
M4	197-492	197-394	197-591	262-591	262-591	262-591							197-558
M5	197-492	197-394	197-591	262-591	262-591	262-591							197-558
K1	197-525	197-525		328-820	328-820	328-820		984-3281	984-3281				197-492
K2	197-525	197-525		328-820	328-820	328-820		984-3281	984-3281				197-492
K3	197-525	197-525		328-820	328-820	328-820		984-3281	984-3281				197-492
K4	197-525	197-525		328-820	328-820	328-820		984-3281	984-3281				197-427
K5	197-525	197-525		328-820	328-820	328-820							164-328
K6	197-525	197-525		328-591	328-591	328-591							164-328
K7	197-525	197-525		328-591	328-591	328-591							164-328
N1	492-2625										984-4921	984-4921	656-2625
N2	492-2625										984-4921	984-4921	656-2625
N3	492-1640										656-2625	656-2625	656-2625
N11	492-1312										591-2625	591-2625	656-2625
S1	66-164		66-262										66-197
S2	66-164		66-262										66-197
S3	66-164		66-262										197-164
S11	66-164		66-262										66-164
S12	66-164		66-262										66-164
S13	66-164		66-262										66-164
H3							262-591	262-591					
H5							262-656	262-656					
H7							262-492	262-492					
H8							262-492	262-492					
H11													
H12													
H21													
H31													

SMG = Grupy materiałowe Seco v_c = m/min (stp/min) Wszystkie parametry są wartościami początkowymi

Wstęp

Wfrczenie

Rozwiercanie

Wytaczanie

Złączenie

Klucze do mocowania płytki i śruby wszystkich wkładek do wytaczania, narzędzi i kaset

		Akcesoria		Części zamienne						
		Klucz Torx do śruby mocującej płytkę*		Śruba mocująca płytkę						
						Dla płytki o wielkości	Oznaczenie	Torx Plus	Oznaczenie	Torx Plus
						CP...0502	T07P-3	07	C02245-T07P	07
						CC...0602	T07P-3	07	C02504-T07P	07
						CC...09T3	T15P-3	15	C04008-T15P	15
						CC...1204	T15P-3	15	C05012-T15P	15
						CC...1605	T15P-3	15	C05012-T15P	15
						SC...0502	T07P-3	07	C02245-T07P	07
						SC...0602	T07P-3	07	C02504-T07P	07
						SC...09T3	T15P-3	15	C04008-T15P	15
SC...1204	T15P-3	15	C05012-T15P	15						
SC...1505	T15P-3	15	C05012-T15P	15						

* Jeden śrubokręt Torx jest dostarczany z każdą głowicą.

		Akcesoria		Części zamienne						
		Klucz Torx do śruby mocującej płytkę*		Śruba mocująca płytkę						
						Dla narzędzia typu Axiabore™	Oznaczenie	Torx Plus	Oznaczenie	Torx Plus
						WB...0301...	T06P-3	06	C02035-T06P	06
						CC...0602...	T07P-3	07	C02504-T07P	07
	-	T15P-3	15	C04008-T15P	15					

Części zamienne do wkładek

		Części zamienne									
		Klucz do płytek		Śruba mocująca płytkę							
						Dla wkładek do wytaczania na gotowo, fazowania i oraz wytaczania wstecznego	Dla płytki o wielkości	Oznaczenie	Torx Plus	Oznaczenie	Torx Plus
						WB...0301...	T06P-2	06	C02035-T06P	06	
						CC...0602...	T07P-3	07	C02504-T07P	07	
						CC...09T3...	T15P-3	15	C04008-T15P	15	
TC...1102...	T07P-3	07	C02504-T07P	07							

		Akcesoria		Części zamienne							
		Klucz Torx do śruby mocującej płytkę*		Śruba mocująca płytkę							
						Dla wkładek	Dla płytki o wielkości	Oznaczenie	Torx Plus	Oznaczenie	Torx Plus
							CC...16...	T15P-2	15	C05012-T15P	15
							SC...15...	T15P-2	15	C05012-T15P	15
							TC...16...	T15P-2	15	C03509-T15P	15
	TC...22...	T15P-2	15	C05012-T15P	15						

Oprawki odpowiednie do głowic wytaczarskich

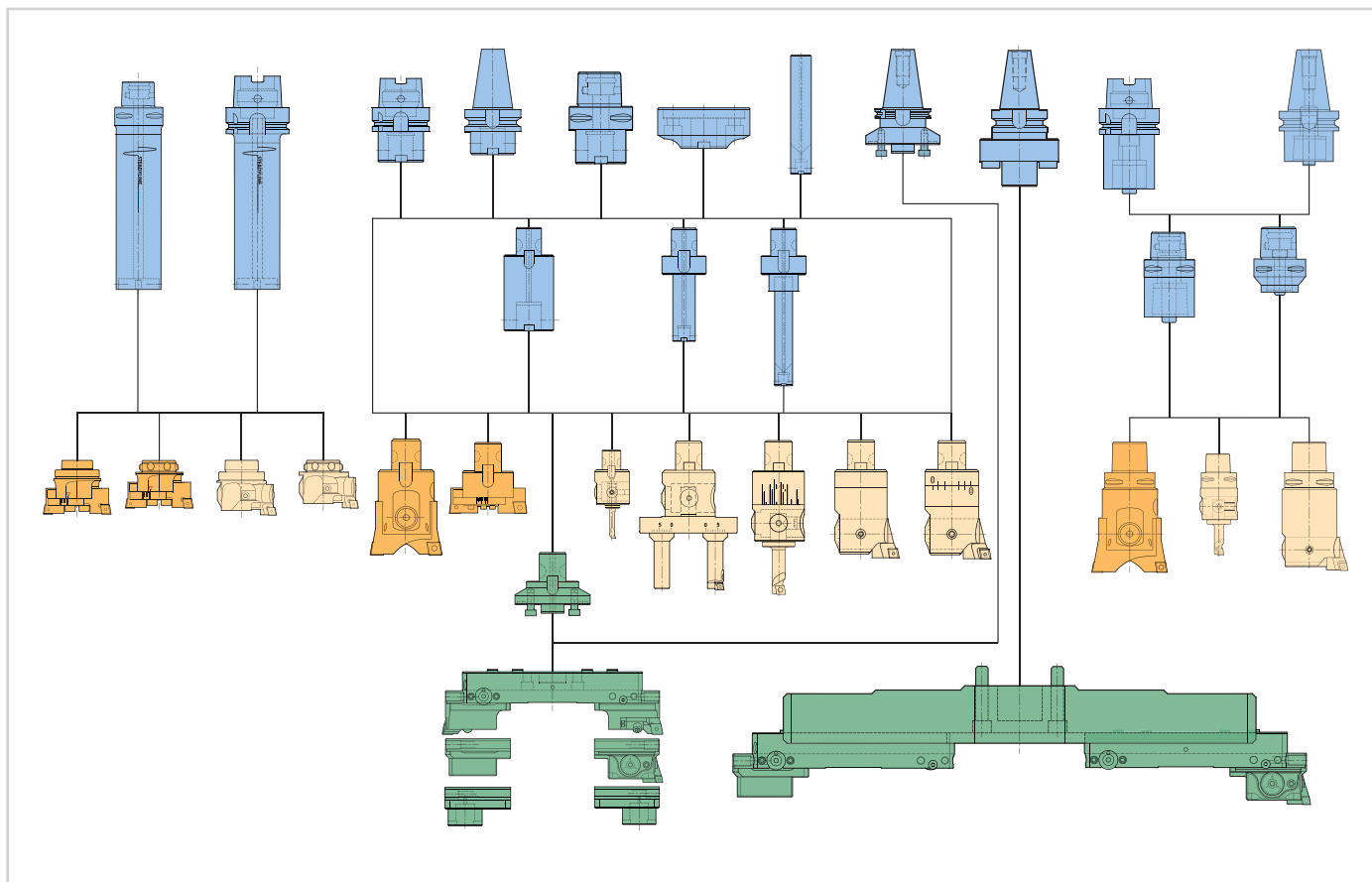

Głowice do wytaczania są wyposażone w połączenia Graflex®, Seco-Capto™, GL lub BA

Głowice wytaczarskie mogą być używane we wszystkich typach obrabiarek, przy zastosowaniu odpowiednich adapterów Graflex®, Seco-Capto™ lub opravek tłumiących drgania Steadyline®.

Steadyline® to system tłumienia drgań dla operacji wytaczania

Głowice wytaczarskie z połączeniem GL lub BA są przeznaczone do mocowania na oprawkach Steadyline® ze stożkiem HSK-T/A lub Seco-Capto™ po stronie obrabiarki. To pozwala na wykonywanie operacji wytaczania z wysięgiem 6xD, 8xD i 10xD z zachowaniem stabilnych warunków.

System modułowy Graflex® i Seco-Capto™ do wytaczania

Odpowiednia długość wytaczania jest uzyskiwana poprzez złożenie elementów pośrednich Graflex®, np. bardzo długa przedłużka z węglika. Największą sztywność mocowania uzyskuje się poprzez wybranie najdłuższej oprawki, a następnie poprzez uzupełnienie jej mniejszymi elementami pośrednimi.

Mocowanie Graflex® i Seco-Capto™ gwarantują dokładne zorientowanie głowic wytaczarskich, zapewniając ustawienie krawędzi skrawającej zgodne z ISO. Moduły Graflex® są projektowane tak aby można było je ze sobą łączyć.

Do mocowania głowic z połączeniem GL do opravek Steadyline®, wybrać możliwie najkrótszą oprawkę Steadyline® z katalogu Systemy Narzędziowe. Oprawki te są dostępne ze stożkiem HSK-T/A i Seco-Capto™. Inne typy opravek można stosować, po użyciu najkrótszego adaptera Seco-Capto™. Wybór opravek Graflex® i Seco-Capto™ oraz elementów pośrednich, patrz katalog SYSTEMY NARZĘDZIOWE.

Belki wytaczarskie, patrz oprawki i adaptery Graflex® str. 643.

Uwaga! Belki Jumbo są przeznaczone do mocowania na oprawkach frezarskich lub bezpośrednio do wrzeciona.

Porady odnośnie klasycznego połączenia Graflex® typu G. w głowicach (zabierak ze śrubą kasującą luz).

W przypadku wytaczania, nie ma potrzeby dokręcania śruby kasującej luz, połączenie samo się blokuje.

W przypadku zgrubnego wytaczania w trudnych warunkach, zalecamy stosowanie 'wyższych wartości' momentów obrotowych dla śrub Graflex® z kulistym zakończeniem.

Patrz również szczegółowa „procedura montażu połączenia Graflex® w katalogu opravek narzędziowych.

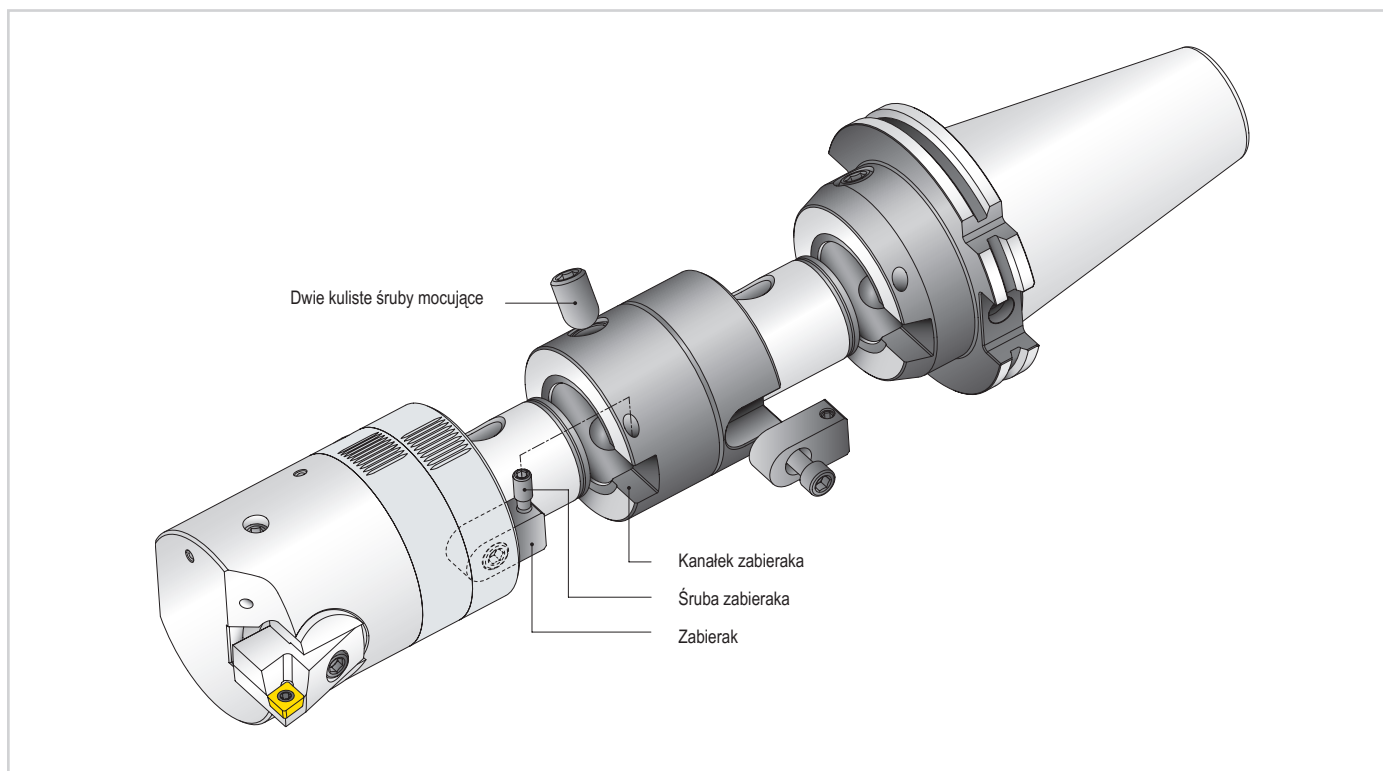

Porady dotyczące mocowania Seco-Capto™ na głowicach: Brak szczególnych porad. Poniżej podano ogólne instrukcje dotyczące głowic.

Momenty dokręcania dla połączeń Seco-Capto™ z centralną śrubą ściągającą (Oprawki podstawowe, elementy pośrednie).

Wielkości Seco-Capto	Moment dokręcania śruby centralnej (Nm)	Moment dokręcania śruby centralnej (ft/lbs)
C3	40-50	30-37
C4	50-60	37-44
C5	90-100	66-74
C6	160-180	118-133
C8	160-180	118-133

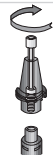

Moment dokręcania dla gniazda Seco-Capto™ z tuleją segmentową, z mocowaniem bocznym (obsady kołnierzone)

Wielkości Seco-Capto	Moment dokręcania (Nm)	Moment dokręcania (ft/lbs)
C3	35	26
C4	50	37
C5	70	52
C6	90	66
C8	130	96

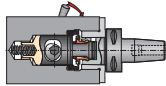

Połączenie Seco-Capto™ posiada samo-mocujący stożek. Gdy stosujemy mechanizm ze śrubą centralną, odkręcamy śrubę do momenty kiedy łeb śruby zetknie się z oprawką, powodując wypchnięcie stożka z gniazda. Gdy stosujemy mechanizm z bocznym zaciskiem, przekręcenie mechanizmu spowoduje wypchnięcie stożka z gniazda.

Tolerancje otworu i wałka według ISO - Tolerancje osiowe

Tolerancja wałka oznaczona jest **małymi literami**
 Tolerancja otworu oznaczona jest **DUŻYMI LITERAMI**



Tabela tolerancji ISO

Tolerancje ISO dla otworów (μm)													
Otwór Ø mm (cal.)	D10	E9	F7	F8	G7	G9	H6	H7	H8	H9	H10	H11	H12
≤ 3 (0.118")	+60 +20	+39 +14	+16 +6	+20 +6	+12 +2	+27 +2	+6 0	+10 0	+14 0	+25 0	+40 0	+60 0	+100 0
3 ≥ 6 (0.236")	+78 +30	+50 +20	+22 +10	+28 +10	+16 +4	+34 +4	+8 0	+12 0	+18 0	+30 0	+48 0	+75 0	+120 0
6 ≥ 10 (0.394")	+98 +40	+61 +25	+28 +13	+35 +13	+20 +5	+41 +5	+9 0	+15 0	+22 0	+36 0	+58 0	+90 0	+150 0
10 ≥ 18 (0.708")	+120 +50	+75 +32	+34 +16	+43 +16	+24 +6	+49 +6	+11 0	+18 0	+27 0	+43 0	+70 0	+110 0	+180 0
18 ≥ 30 (1.181")	+149 +65	+92 +40	+41 +20	+53 +20	+28 +7	+59 +7	+13 0	+21 0	+33 0	+52 0	+84 0	+130 0	+210 0
30 ≥ 50 (1.969")	+180 +80	+112 +50	+50 +25	+64 +25	+34 +9	+71 +9	+16 0	+25 0	+39 0	+62 0	+100 0	+160 0	+250 0
50 ≥ 65 (2.559")	+220 +100	+134 +60	+60 +30	+76 +30	+40 +10	-	+19 0	+30 0	+46 0	+74 0	+120 0	+190 0	+300 0
65 ≥ 80 (3.150")													
80 ≥ 100 (3.937")	+260 +120	+159 +72	+71 +36	+90 +36	+47 +12	-	+22 0	+35 0	+54 0	+87 0	+140 0	+220 0	+350 0
100 ≥ 120 (4.724")													
120 ≥ 140 (5.512")	+305 +145	+185 +85	+83 +43	+106 +43	+54 +14	-	+25 0	+40 0	+63 0	+100 0	+160 0	+250 0	+400 0
140 ≥ 160 (6.299")													
160 ≥ 180 (7.087")													
180 ≥ 200 (7.874")	+355 +170	+215 +110	+96 +50	+122 +50	+61 +15	-	+29 0	+46 0	+72 0	+115 0	+185 0	+290 0	+460 0
200 ≥ 225 (8.858")													
225 ≥ 250 (9.843")													
250 ≥ 280 (11.0236")	+400 +190	+240 +110	+108 +56	+137 +56	+69 +17	-	+32 0	+52 0	+81 0	+130 0	210 0	+320 0	+520 0
280 ≥ 315 (12.402")													
315 ≥ 355 (13.976")	+440 +210	+265 +125	+119 +62	+151 +62	+75 +18	-	+36 0	+57 0	+89 0	+140 0	+230 0	+360 0	+570 0
355 ≥ 400 (15.748")													

Wstęp

Wiercenie

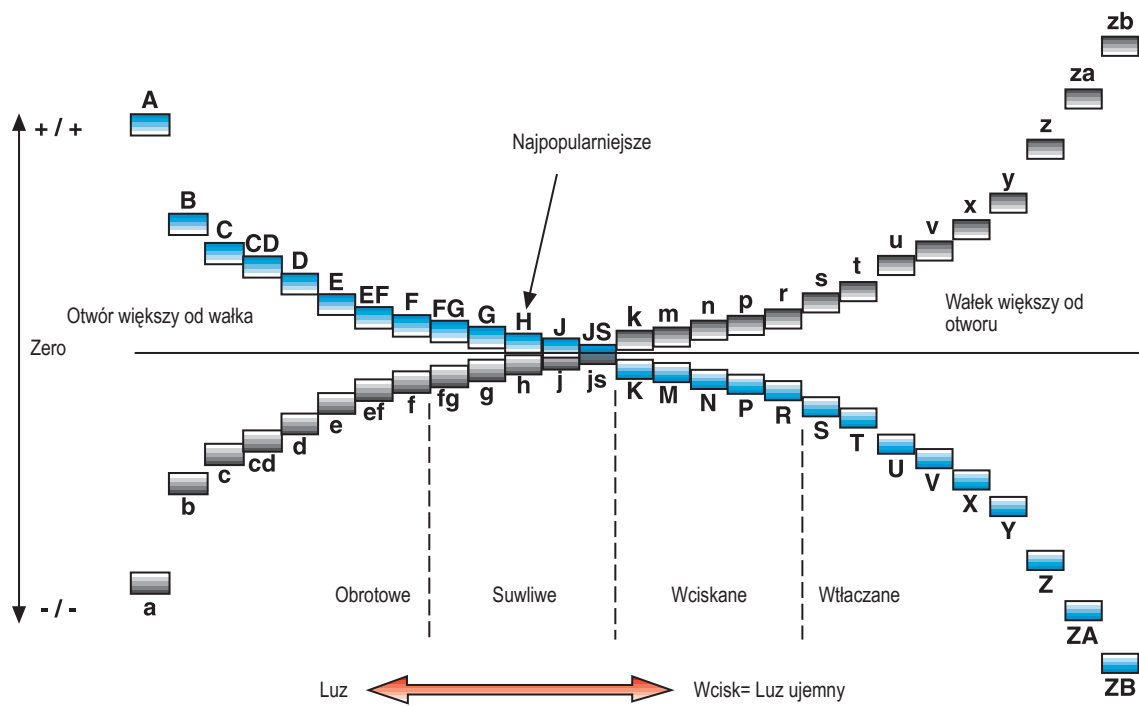
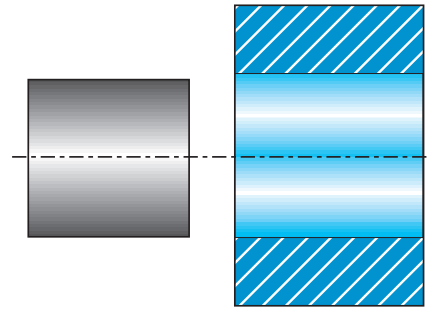
Rozwiercanie

Wylaczanie

Załącznik

Tabela tolerancji ISO

Tolerancje ISO dla otworów (μm)												
Otwór Ø mm (cal.)	H13	JS7	JS9	K6	K7	M6	M7	N7	N9	P7	P9	R7
≤ 3 (0.118")	+140 0	+/-5	+/-12,5	0 -6	0 -10	-2 -8	-2 -12	-4 -14	-4 -29	-6 -16	-6 -31	-10 -20
3 ≥ 6 (0.236")	+180 0	+/-6	+/-15	+2 -6	+3 -9	-1 -9	0 -12	-4 -16	0 -30	-8 -20	-12 -42	-11 -23
6 ≥ 10 (0.394")	+220 0	+/-7,5	+/-18	+2 -7	+5 -10	-3 -12	0 -15	-4 -19	0 -36	-9 -24	-15 -51	-13 -28
10 ≥ 18 (0.708")	+270 0	+/-9	+/-21,5	+2 -9	+6 -12	-4 -15	0 -18	-5 -23	0 -43	-11 -29	-18 -61	-16 -34
18 ≥ 30 (1.181")	+330 0	+/-10,5	+/-26	+2 -11	+6 -15	-4 -17	0 -21	-7 -28	0 -52	-14 -35	-22 -74	-20 -41
30 ≥ 50 (1.969")	+390 0	+/-12,5	+/-31	+3 -13	+7 -18	-4 -20	0 -25	-8 -33	0 -62	-17 -42	-26 -88	-25 -50
50 ≥ 65 (2.559")	+460 0	+/-15	+/-37	+4 -15	+9 -21	-5 -24	0 -30	-9 -39	0 -74	-21 -51	-32 -106	-30 -62
65 ≥ 80 (3.150")												
80 ≥ 100 (3.937")	+260 +120	+159 +72	+71 +36	+90 +36	+47 +12	-	+22 0	+35 0	+54 0	+87 0	+140 0	+350 0
100 ≥ 120 (4.724")												
120 ≥ 140 (5.512")	+305 +145	+185 +85	+83 +43	+106 +43	+54 +14	-	+25 0	+40 0	+63 0	+100 0	+160 0	+400 0
140 ≥ 160 (6.299")												
160 ≥ 180 (7.087")												
180 ≥ 200 (7.874")	+355 +170	+215 +110	+96 +50	+122 +50	+61 +15	-	+29 0	+46 0	+72 0	+115 0	+185 0	+460 0
200 ≥ 225 (8.858")												
225 ≥ 250 (9.843")												
250 ≥ 280 (11.0236")	+400 +190	+240 +110	+108 +56	+137 +56	+69 +17	-	+32 0	+52 0	+81 0	+130 0	210 0	+520 0
280 ≥ 315 (12.402")												
315 ≥ 355 (13.976")	+440 +210	+265 +125	+119 +62	+151 +62	+75 +18	-	+36 0	+57 0	+89 0	+140 0	+230 0	+570 0
355 ≥ 400 (15.748")												

Wstęp





Wiercenie

Rozwiercanie

Wytaczanie

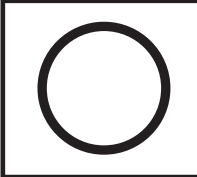
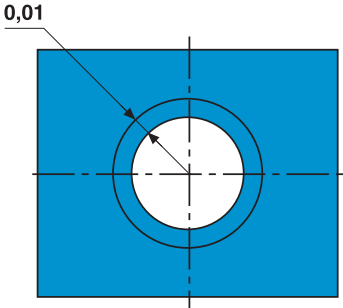
Załącznik

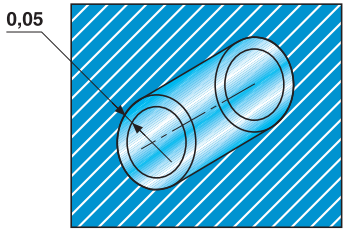
Tolerancja kształtu i położenia

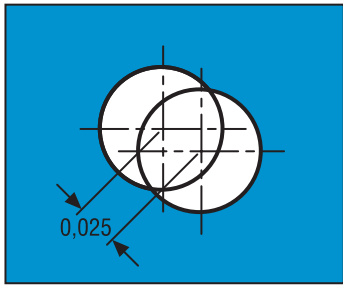
	Symbol rysunku	Pole tolerancji	
Kołowość	 <table border="1" data-bbox="805 584 1008 759"> <tr> <td>0,01 mm (0.0004")</td> </tr> </table>	0,01 mm (0.0004")	
0,01 mm (0.0004")			
Cylindryczność	 <table border="1" data-bbox="805 999 1008 1173"> <tr> <td>0,05 mm (0.0020")</td> </tr> </table>	0,05 mm (0.0020")	
0,05 mm (0.0020")			
Pozycjonowanie	 <table border="1" data-bbox="805 1429 1008 1603"> <tr> <td>0,05 mm (0.0020")</td> </tr> </table>	0,05 mm (0.0020")	
0,05 mm (0.0020")			

Stale, ferrytyczne i martenzytyczne stale nierdzewne

SMG	Opis	Właściwości	Oznac.	$k_{c1.1}$	m_c
P1	Stale łatwe w obróbce.	$360 < R_m < 880$	11 SMn30 $R_m = 385 \text{ N/mm}^2$	1500	0,14
P2	Niskostopowe stale ferrytyczne, $C < 0.25\% \text{wg}$ Niskostopowe spawalne stale konstrukcyjne	$320 < R_m < 600$	S235JRG2 $R_m = 420 \text{ N/mm}^2$	1600	0,23
P3	Stale ferrytyczne i ferrytyczno-perlityczne, $C < 0.25\% \text{wg}$ Spawalne stale konstrukcyjne Stale do nawęglania	$430 < R_m < 610$	16 MnCr 5 $R_m = 550 \text{ N/mm}^2$	1800	0,14
P4	Niskostopowe stale konstrukcyjne, $0.25\% < C < 0.67\% \text{wg}$ Niskostopowe stale hartowane i odpuszczane	$520 < R_m < 1200$	C 45E $R_m = 660 \text{ N/mm}^2$	2000	0,15
P5	Stale konstrukcyjne, $0.25\% < C < 0.67\% \text{wt}$ Stale hartowane i odpuszczane	$550 < R_m < 1200$	42 CrMo 4 $R_m = 700 \text{ N/mm}^2$	2020	0,18
P6	Niskostopowe stale hartowane na wskroś, $C > 0.67\% \text{wg}$ Niskostopowe stale sprężynowe i łożyskowe	$520 < R_m < 1200$	C 100S $R_m = 600 \text{ N/mm}^2$	2100	0,17
P7	Stale hartowane na wskroś, $C > 0.67\% \text{wg}$ Stale sprężynowe i łożyskowe	$600 < R_m < 1200$	100 Cr 6 $R_m = 650 \text{ N/mm}^2$	2160	0,17
P8	Stale narzędziowe Stale szybko tnące (HSS)	$600 < R_m < 1200$	X 40 CrMoV 5 1 $R_m = 700 \text{ N/mm}^2$	2400	0,20
P11	Stale nierdzewne ferrytyczne i martenzytyczne	$415 < R_m < 1200$	X 20 Cr 13 $R_m = 675 \text{ N/mm}^2$	2000	0,15
P12	Stale starzone i przesycane węglenem	$500 < R_m < 1200$	X 5 CrNiCuNb 16 4 $R_m = 1100 \text{ N/mm}^2$	2100	0,17

Stale nierdzewne automatowe austenityczne i duplex

SMG	Opis	Właściwości	Oznac.	$k_{c1.1}$	m_c
M1	Stale nierdzewne austenityczne automatowe		X 10 CrNiS 18 9	1700	0,14
M2	Niskostopowe stale nierdzewne austenityczne		X 5 CrNi 18 10	1920	0,18
M3	Średniostopowe stale nierdzewne austenityczne		X 2 CrNiMo 18 14 3	2070	0,17
M4	Wysokostopowe stale nierdzewne austenityczne i duplex		X 2 CrNiMoN 22 5 3	2230	0,16
M5	Trudno-obrabialne stale nierdzewne wysokostopowe austenityczne i duplex		X 2 CrNiMoN 25 7 4	2510	0,13

Żeliwa

SMG	Opis	Właściwości	Oznac.	$k_{c1.1}$	m_c
K1	Żeliwa szare (GCI)		EN-GJL-250	930	0,32
K2	Żeliwo wermikularne (CGI)		EN-GJV-400	1000	0,35
K3	Żeliwa ciągliwe (MCI)		EN-GJMB-550-4	1050	0,37
K4	Żeliwa sferoidalne (SGI)		EN-GJS-500-7	1160	0,37
K5	Żeliwo sferoidalne hartowane izotermicznie (ADI)		EN-GJS-1000-5		
K6	Austenityczne żeliwo z grafitem płatkowym		EN-GJLA-XNiCuCr15-6-2		
K7	Austenityczne żeliwo sferoidalne		EN-GJSA-XNiMn23-4		

Metale nieżelazne

SMG	Opis	Właściwości	Oznac.	$k_{c1.1}$	m_c
N1	Stopy aluminium, Si < 9%		AW-7075		
N2	Stopy aluminium, 9% < Si < 16%		AC-44200 Si = 12%		
N3	Stopy aluminium, Si > 16%		AISI17Cu5		
N11	Stopy miedzi		CW614N	740	0,26

Superstopy i stopy tytanu

SMG	Opis	Właściwości	Oznac.	$k_{c1.1}$	m_c
S1	Superstopy na bazie żelaza		Disalloy		
S2	Superstopy na bazie kobaltu		Stellite 21		
S3	Superstopy na bazie niklu		Inconel 718	2530	0,21
S11	Tytan, niskostopowy, (α)		Ti		
S12	Tytan, średniostopowy, ($\alpha+\beta$)		TiAl6V4	1500	0,24
S13	Tytan, wysokostopowy, (blisko β i β)		Ti10V2Fe3Al		

Materiały utwardzane

SMG	Opis	Właściwości	Oznac.	$k_{c1.1}$	m_c
H3	Stale do nawęglania	58 < HRC < 62	16 MnCr 5 60 HRC	2070	0,14
H5	Stale hartowane i odpuszczone	38 < HRC < 56	42 CrMo 4 50 HRC	2320	0,18
H7	Stale hartowane i odpuszczone Stale łożyskowe	56 < HRC < 64	100 Cr 6 60 HRC	2480	0,17
H8	Stale narzędziowe Stale szybko tnące (HSS)	38 < HRC < 64	X 40 CrMoV 5 1 50 HRC	2750	0,20
H11	Stale nierdzewne martenzytyczne	38 < HRC < 50	X 20 Cr 13 45 HRC	2300	0,15
H12	Stale nierdzewne starzone i przesypane wydzieleniowo	1200 < R_m < 1650	X 5 CrNiCuNb 16 4 $R_m = 1450 \text{ N/mm}^2$	2410	0,17
H21	Stale manganowe	23 < HRC < 64	X 120 Mn 12 50 HRC		
H31	Żeliwo białe	50 < HRC < 64	EN-GJN-HV600(XCr11) 55 HRC		

Inne trudne materiały

SMG	Opis	Właściwości	Oznac.	$k_{c1.1}$	m_c
PM1	Niskostopowe materiały PM		F-0008 Fe-0.7C		
PM2	Średniostopowe materiały PM		FLC-4608 Fe2Cu1.8Ni 0.5Mo0.2Mn0.8C		
PM3	Wysokostopowe materiały PM Gniazda zaworów wylotowych, itp.				
HF1	Stopy do napawania Stopy na bazie żelaza spawalne lub napawane plazmowo				
HF2	Stopy do napawania Stopy na bazie kobaltu i niklu spawalne lub napawane plazmowo				
CC1	Spiekany węgiel wolframu		G50		

Tworzywa i kompozyty

SMG	Opis	Właściwości	Oznac.	$k_{c1.1}$	m_c
TS1	Polimery termoutwardzalne		Tworzywa mocznikowo formaldehydowe (UF)		
TS2	Termoutwardzalne kompozyty z włóknem węglowym		T300 T700 T800 HTA-S IMA - Epoxy (M21)...		
TS3	Termoutwardzalne kompozyty z włóknem szklanym		Epoxy - HX..(42..)E glass (7781...)...		
TS4	Termoutwardzalne kompozyty z włóknem aramidowym		Kevlar 49		
TP1	Polimery termoplastyczne		Poliwęglan (PC)		
TP2	Termoplastyczne kompozyty z włóknem węglowym		PPS/PEEK - T300..		
TP3	Termoplastyczne kompozyty z włóknem szklanym		PPS/PEEK - E glass lub A glass...		
TP4	Termoplastyczne kompozyty z włóknem aramidowym				

Grafit

SMG	Opis	Właściwości	Oznac.	$k_{c1.1}$	m_c
GR1	Grafit		R 8500		

SMG

SMG	EN	EN-Nr	W.-Nr	DIN	AFNOR	BS	UNI	JIS	SS	UNS	
P1	11 SMn 30	1.0715	1.0715	9 SMn 28	S 250	230 M 07	CF 9 SMn 28	SUM 22	1912	G12130	
	11 SMnPb 30	1.0718	1.0718	9 SMnPb 28	S 250 Pb		CF 9 SMnPb 28	SUM 22 L	1914	G12134	
	10 S 20	1.0721	1.0721	10 S 20	10 F 1	210 M 15	CF 10 S 20				
			1.0722	10 SPb 20	10 PbF 2		CF 10 SPb 20				
	15 SMn 13	1.0725	1.0723	15 S 20		210 A 15		SUM 32	1922		
	35 S20	1.0726	1.0726	35 S 20	35 MF 4	212 M 36			1957	G11400	
	46 S20	1.0727	1.0727	46 S 20	46 S 20	212 M 44			1973	G11460	
	11 SMn 37	1.0736	1.0736	9 SMn 36	S 300	240 M 07	CF 9 SMn 36			G12150	
11 SMn 37	1.0736	1.0736	9 SMn 36	S 300	240 M 07	CF 9 SMn 36			G12150		
S235JR	1.0037	1.0037	St 37-2	E 24-2		Fe 360 B	STKM 12 C	1311			
S235JRG2	1.0038	1.0116	St 37-3	E 24-3, E 24-4	4360-40 C	Fe 360 D FF		1312, 1313			
S275J2G3	1.0144	1.0144	St 44-3 N	E 28-3, E 28-4	4360-43 C	Fe 430 D FF	SM 41 C	1412, 1414			
C 10	1.0301	1.0301	C 10	34 C 10, XC 10	045 M 10	C 10	S 10 C			G10100	
		1.0401	C 15	37 C 12, XC 18	080 M 15	C 15, C 16		1350		G10170	
C22	1.0402	1.0402	C 22	C 20	050 A 20	C 20, C 21		1450		G10200	
S355JR	1.0570	1.0570	St 52-3	E 36-3, E 36-4	4360-50 C	Fe 510 B	SM 50 YA	2172, 2132			
C 15R	1.1141	1.1141	Ck 15	XC 15, XC 18	080 M 15	C 15, C 16		1370		G10170	
		1.1158	Ck 25	XC 25	060 A 25	C 25	S 25 C			G10250	
		1.2162	21 MnCr 5	20 NC 5			SCR 420 H				
P3	16 Mo 3	1.5415	1.5415	15 Mo 3	15 D 3	1501-240	16 Mo 3		2912		
			1.5423	16 Mo 5		1503-245-420	16 Mo 5	SB 450 M		G45200	
	14 NiCr 14	1.5752	1.5752	14 NiCr 14	12 NC 15	655 M 13		SNC 815 (H)		G33106	
			1.5919	15 CrNi 6	16 NC 6	S 107	16 CrNi 4				
	18 NiCrMo 7 6	1.6587	1.6587	18 CrNiMo 7 6	18 NCD 6	820 A 16	18 NiCrMo 7				
	16 MnCr 5	1.7131	1.7131	16 MnCr 5	16 MC 5	527 M 17	16 MnCr 5	SCR 415	2511		G51170
	16 MnCrS 5	1.7139	1.7139	16 MnCrS 5							
	20 MnCr 5	1.7147	1.7147	20 MnCr 5	20 MC 5		20 MnCr 5	SMnC 420 (H)			G51200
	20 MnCrS 5	1.7149	1.7149	20 MnCrS 5	20 MnCrS 5			SMnC 21 H			
	13 CrMo 4 5	1.7335	1.7335	13 CrMo 4 4	15 CD 3.5	1501-620 Gr. 27	14 CrMo 4 5		2216		
		1.7337	16 CrMo 4 4	15 CD 4.5	1501-620 Gr. 27	14 CrMo 4 5		2216			
10 CrMo 9 10	1.7380	1.7380	10 CrMo 9 10	10 CD 9.10	1501-622 Gr. 31	12 CrMo 9 10		2218		J21890	
P4	C35		1.0501	C 35	55 C 35	060 A 35	C 35		1550	G10350	
	E 335	1.0503	1.0503	C 45	65 C 45	80 M 46	C 45	S 45 C	1650	G10430	
	C40		1.0511	C 40	60 C 40	080 M 40		S 40 C			
	E 360	1.0070	1.0535	St 70-2	A 70-2		Fe 690		1655		
	C60	1.0601	1.0601	C 60	CC 55	080 A 62	C 60			G10600	
			1.1157	40 Mn 4	35 M 5	150 M 36				G10390	
	G 28 Mn6	1.1165	1.1165	30 Mn 5		120 M 36		SMn 1 H, SCMn 2		G13300	
	C 35E	1.1181	1.1181	Ck 35	XC 38 H1	080 M 36	C 35	S 35 C	1572	G10340	
	C 45E	1.1191	1.1191	Ck 45	XC 42	080 M 46	C 45	S 45 C	1672	G10420	
	C 60E	1.1221	1.1221	Ck 60	XC 60	080 A 62	C 60	S 58 C	1665, 1678	G10640	
P5			1.1740	C 60 W	Y3 55			SK 7			
	55 SiCr7	1.7100	1.0904	55 Si 7	55 S 7	250 A 53	55 Si 8		2085, 2090		
			1.2330	35 CrMo 4	34 CD 4	708 A 37	35 CrMo 4			T51620	
			1.2542	45 WCrV 7		BS 1	45 WCrV 8 KU		2710	T41901	
			1.2714	56 NiCrMoV 7		BH 224-5	56 NiCrMoV7-KU	SKT 4		T61206	
			1.5121	46 MnSi 4							
			1.5710	36 NiCr 6	35 NC 6	640 A 35			SNC 236		
			1.5736	36 NiCr 10	35 NC 11		35 NiCr 9	SNC 631 (H)			
	36 CrNiMo 4		1.6511	36 CrNiMo 4	40 NCD 3	816 M 40	38 NiCrMo 4 (KB)			G98400	
	34 CrNiMo 6	1.6582	1.6582	34 CrNiMo 6	35 NCD 6	817 M 40	35 NiCrMo 6 (KW)	SNCM 447	2541	G43400	
	34 Cr 4	1.7033	1.7033	34 Cr 4	32 C 4	530 A 32	34 Cr 4 (KB)	SCR 430 (H)		G51320	
	41 Cr 4	1.7035	1.7035	41 Cr 4	42 C 4	530 M 40	41 Cr 4	SCR 440 (H)		G51400	
	25 CrMo 4	1.7218	1.7218	25 CrMo 4	25 CD 4 S	708 M 25	25 CrMo 4 (KB)	SCM 425	2225	G41300	
	42 CrMo 4	1.7225	1.7225	42 CrMo 4	42 CD 4	708 M 40	42 CrMo 4	SCM 440 (H)	2244	G41400	
	42 CrMo 4	1.7225	1.7225	42 CrMo 4	42 CD 4	708 M 40	42 CrMo 4	SCM 440 (H)	2244	G41400	
		1.7361	32 CrMo 12	30 CD 12	722 M 24	32 CrMo 12		2240			
50 CrV 4	1.8159	1.8159	50 CrV 4	50 CV 4	735 A 50	51 CrV 4	SUP 10	2230	H61500		
41 CrAlMo 7 10	1.8509	1.8509	41 CrAlMo 7	40 CAD 6.12	905 M 39	41 CrAlMo 7	SACM 645	2940	K24065		
C 67S	1.1231	1.1231	Ck 67	XC 68	060 A 67	C 70		1770	G10700		
C 100S	1.1274	1.1274	Ck 101		060 A 96		SUP 4	1870	G10950		
C 105U	1.1545	1.1545	C 105 W1	Y1 105		C 100 KU		1880			
		1.1645	C 105 W2	Y1 105		C 100 KU	SK 3				
		1.1663	C 125 W	Y2 120		C 120 KU	SK 2				

Wstęp

Wiercenie

Rozwiercanie

Wytaczanie

Załącznik

SMG

U.N.E./ I.H.A.	AISI / ASTM	GOST	ČSN	Inne marki	Warunki	Struktura
	1213				Wyżarzony	
	12 L 13				Wyżarzony	
	1108				Wyżarzony	
	11 L 08				Wyżarzony	
					Wyżarzony	
	1140	40			Wyżarzony	
	1146				Wyżarzony	
	1215				Wyżarzony	
	12 L 14				Wyżarzony	
		16D			Wyżarzony	
	A573 Grade 58	18kp	11 378		Wyżarzony	
	A573 Grade 70	S14kP	11 448		Wyżarzony	
	1010	10			Wyżarzony	
F.1110	1015	15			Wyżarzony	
	1020, 1023	20	12 024		Wyżarzony	
		17G1S	11 523		Wyżarzony	
F.1511	1015	15			Wyżarzony	
F.1120	1025	25			Wyżarzony	
					Wyżarzony	
	A204 Grade A		15 020		Wyżarzony	
	4520				Wyżarzony	
	3310, 9314	20X2H4A	16 420		Wyżarzony	
	4320		16 220		Wyżarzony	
					Wyżarzony	
F.1516	5115	12KHN2	14 220		Wyżarzony	
		18HG			Wyżarzony	
	5120	20KH	14 221		Wyżarzony	
	5120 H	20KH			Wyżarzony	
	A182-F11, A182-F12	12KHM	15 121		Wyżarzony	
	A387 Grade 12 Cl. 2				Wyżarzony	
F.155	A182-F22	12KH8	15 313		Wyżarzony	
F.1130	1035	35	12 040		Wyżarzony	
F.5110	1045	45	12 050		Wyżarzony	
	1040	40	12 041		Wyżarzony	
F.1150	1055	55			Wyżarzony	
	1060	60	12 061		Wyżarzony	
	1039	40G			Wyżarzony	
	1330	30G2			Wyżarzony	
F.1135	1035	35			Wyżarzony	
F.1140	1045	45	12 050		Wyżarzony	
F.1150	1064	60			Wyżarzony	
	1060	60			Wyżarzony	
F.144	9255	55S2			Wyżarzony	
F.1250	4135	35KHM			Wyżarzony	
F.5241	S1	5KHV2S			Wyżarzony	
	L6	5KHNV			Wyżarzony	
	5045				Wyżarzony	
	3135				Hartowane & odpuszczane	
	3435				Wyżarzony	
	9840				Hartowane & odpuszczane	
F.1280	4340	38H2N2MA	16 343		Wyżarzony	
	5132	35KH			Hartowane & odpuszczane	
	5140	40H	14 140		Hartowane & odpuszczane	
F.1251	4130	20KHM	15 130		Hartowane & odpuszczane	
F.1252	4142, 4140	38HM	15 142		Wyżarzony	
F.1252	4142, 4140	38HM	15 142		Hartowane & odpuszczane	
					Hartowane & odpuszczane	
F.143	6150	50KHFA	15 260		Hartowane & odpuszczane	
F.1740	A355 Cl. A				Wyżarzony	
F.5103	1070	70			Wyżarzony	
F.5117	1095				Wyżarzony	
F.5118	W1	U10A			Wyżarzony	
		U10			Wyżarzony	
	W1	U13			Wyżarzony	

Wstęp

Wfiercenie

Rozzwiercanie

Wytłaczanie

Załącznik

SMG

SMG	EN	EN-Nr	W.-Nr	DIN	AFNOR	BS	UNI	JIS	SS	UNS	
P7	107 CrV 3	1.2210	1.2210	115 CrV 3	100 C 3		107 CrV 3 KU			T61202	
			1.2510	100 MnCrW 4	90 MWCV 5	BO 1	95 MnWCr 5 KU	SKS 3	2140	T31501	
	90 MnCrV 8	1.2842	1.2842	90 MnCrV 8	90 MV 8	BO 2	90 MnVCr 8 KU			T31502	
	100 Cr 6	1.3505	1.3505	100 Cr 6	100 C 6	534 A 99	100 Cr 6	SUJ 2	2258	G51986	
P8	X 210 Cr 12	1.2080	1.2080	X 210 Cr 12	Z 200 C 12	BD 3	X 210 Cr 13 KU	SKD 1		T30403	
			1.2343	X 38 CrMoV 5 1	Z 38 CDV 5	BH 11	X 37 CrMoV 5 1 KU	SKD 6		T20811	
	X 40 CrMoV 5 1	1.2344	1.2344	X 40 CrMoV 5 1	Z 40 CDV 5	BH 13	X 40 CrMo 5 1 1 KU	SKD 61	2242	T20813	
	X 100 CrMoV 5	1.2363	1.2363	X 100 CrMoV 5 1	Z 100 CDV 5	BA 2	X 100 CrMoV 5 1 KU	SKD 12	2260	T30102	
			1.2365	X 32 CrMoV 3 3	32 DCV 28	BH 10	30 CrMoV 12 27 KU	SKD 7		T20810	
			1.2436	X 210 CrW 12			X 215 CrW 12 1 KU	SKD 2		2312	
			1.2601	X 165 CrMoV 12			X 165 CrMoV 12 KU			2310	
			1.2713	55 NiCrMoV 6	55 NCDV 7			SKT 4			T61206
	HS 6-5-2-5	1.3243	1.3243	S 6-5-2-5	Z 85 WDKCV 06-05-05-04-02		HS 6-5-2-5	SKH 55		2723	
	HS 2-10-1-8	1.3247	1.3247	S 2-10-1-8	Z 110 DKCWW 09-08-04	BM 42	HS 2-9-1-8	SKH 51			T11342
	HS 18-1-2-5	1.3255	1.3255	S 18-1-2-5	Z 80 WKCW 18-05-04-01	BT 4	HS 18-1-1-5	SKH 3			T12004
HS 6-5-2	1.3343	1.3343	S 6-5-2	Z 85 WDCV 06-05-04-02	BM 2	HS 6-5-2	SKH 9, SKH 51		2722	T11302	
HS 2-9-2	1.3348	1.3348	S 2-9-2	Z 100 DCWW 09-04-02-02		HS 2-9-2	SKH 58		2782	T11307	
HS 18-0-1	1.3355	1.3355	S 18-0-1	Z 80 WCV 18-04-01	BT 1	HS 18-0-1	SKH 2			T12001	
P11	X 6 Cr 13	1.4000	1.4000	X 6 Cr 13	Z 6 C 12	403 S 17	X 6 Cr 13	SUS 403	2301	S41008	
	X 12 Cr 13	1.4006	1.4006	X 10 Cr 13	Z 10 C 13	410 S 21	X 12 Cr 13	SUS 410	2302	S41000	
	X 6 Cr 17	1.4016	1.4016	X 6 Cr 17	Z 8 C 17	430 S 15	X 8 Cr 17	SUS 430	2320	S43000	
	X 20 Cr 13	1.4021	1.4021	X 20 Cr 13	Z 20 C 13	420 S 37	X 20 Cr 13	SUS 420 J 1	2303	S42000	
	X 39 Cr 13	1.4031	1.4031	X 40 Cr 13	Z 40 C 14	420 S 45	X 40 Cr 14	SUS 420	2304	S40280	
	X 70 CrMo 15	1.4109	1.4109	X 65 CrMo 14	Z 70 D 14			SUS 440 A		S44002	
	X 90 CrMoV 18	1.4112	1.4112	X 90 CrMoV 18	Z 2 CND 18 05	409 S 19	X CrTi 12	SUS 440 B	2327	S44003	
	X 105 CrMo 17	1.4125	1.4125	X 105 CrMo 17	Z 100 CD 17		X 105 CrMo 17	SUS 440 C		S44004	
	X 3 CrNiMo 13 3	1.4313	1.4313	X 5 CrNi 13 4	Z 5 CN 13 4	425 C 11	X 6 CrNi 13 04	SCS 5		2385	S41500
	X 18 CrN 28	1.4749	1.4749	X 18 CrN 28	Z 18 C 25					2322	S44600
	P12	X 6 NiCrTiMoV 25 15	1.4534	1.4534	X 3 CrNiMoAl 13 8 2						S13800
X 4 CrNiCuNb 16 4		1.4540	1.4540	X 4 CrNiCuNb 16 4						S15500	
		1.4540	1.4540	X 4 CrNiCuNb 16 4	Z 4 CNUNb 16.4 M					S15500	
X 4 CrNiCuNb 16 4		1.4540	1.4540	X 4 CrNiCuNb 16 4						S15500	
X 5 CrNiCuNb 16 4		1.4542	1.4542	X 5 CrNiCuNb 16 4				SUS 630		S17400	
X 5 CrNiCuNb 17 4		1.4548	1.4548	X 5 CrNiCuNb 17 4	Z 6 CNU 17.4			SCS 24, SUS 630		S17400	
X 7 CrNiAl 17 7		1.4564	1.4564	X 7 CrNiAl 17 7	Z 9 CAN 17.7	301 S 81	X 7 CrNiAl 17 7	SUS 631	2388	S17700	
X 2 NiCoMoTi 18 12 4		1.6356	1.6356	X 2 NiCoMoTi 18 12 4						K93160	
X 2 NiCoMoTi 18 9 5		1.6358	1.6358	X 2 NiCoMoTi 18 9 5	Z 2 NKD 19-09					K93120	
X 2 NiCoMo 18 9 5		1.6358	1.6358	X 2 NiCoMoTi 18 9 5	Z 2 NKD 19-09					K93120	
X 2 NiCoMo 18 8 5		1.6359	1.6359	X 2 NiCoMo 18 8 5		S 162				K92890	
X 2 NiCoMo 18 8 5	1.6359	1.6359	X 2 NiCoMo 18 8 5		S 162				K92890		
M1	X 10 CrNiS 18 9	1.4305	1.4305	X 10 CrNiS 18 9	Z 10 CNF 18.09	303 S 31	X 10 CrNi 18 09	SUS 303	2346	S30300	
	X 2 CrNi 19 11	1.4306	1.4306	X 2 CrNi 19 11	Z 2 CN 18.10	304 S 12	X 3 Cr Ni 18 11	SUS 304 L	2352	S30403	
M2	X 5 CrNi 18 10	1.4301	1.4301	X 5 CrNi 18 10	Z 6 CN 18.09	304 S 31	X 5 CrNi 18 11	SUS 304	2333	S30400	
	X 5 CrNiMo 17 12 2	1.4401	1.4401	X 5 CrNiMo 17 12 2	Z 3 CND 17.11.1	316 S 31	X 5 CrNiMo 17 12	SUS 316	2347	S31600	
	X 6 CrNiNb 18 10	1.4550	1.4550	X 6 CrNiNb 18 10	Z 6 CNNb 18.10	347 S 31	X 6 CrNiNb 18 11	SUS 347	2338	S34700	
	X 9 CrNi 18 8	1.4310	1.4310	X 12 CrNi 17 7	Z 12 CN 17.07	301 S 21	X 12 CrNi 17 07	SUS 301	(2331)	S30100	
	X 12 CrNi 18 8	1.4300	1.4300	X 12 CrNi 18 8	Z 12 CN 18	302 S 25		SUS 302	2331	S30200	
	X 2 CrNiMo 18 14 3	1.4435	1.4435	X 2 CrNiMo 18 14 3	Z 2 CND 17.13	316 S 12	X 2 CrNiMo 17 13 2	SCS 16, SUS 316 L	2353	S31603	
M3	X 2 CrNiMoN 17 13 3	1.4429	1.4429	X 2 CrNiMoN 17 13 3	Z 2 CND 17.13 Az	316 S 62	X 2 CrNiMoN 17 13 3	SUS 316 LN	2375	S31653	
	X 2 CrNiN 18 10	1.4311	1.4311	X 2 CrNiN 19 11	Z 2 CN 18 .10 Az	304 S 62	X 2 CrNiN 18 11	SUS 304 LN	2371	S30453	
	X 3 CrNiMo 18 12 3	1.4466	1.4466	X 5 CrNi 18 15		317 S 16	X 5 CrNi 18 15	SUS 317	2366	S31700	
	X 9 CrNiSiN 21 11 2	1.4835	1.4893	X 9 CrNiSiN 21 11 2		310 S 31			2368	S30815	
	X 12 CrNi 25 21	1.4335	1.4335	X 12 CrNi 25 21	Z 12 CN 25.20	310 S 24	X 6 CrNi 26 20	SUH 310, SUS 310 S	2361	S31008	
M4	X 2 CrNiMoN 22 5 3	1.4462	1.4462	X 2 CrNiMoN 22 5	Z 2 CND 22.05 Az	332 S 15	X 2 CrNiMoN 22 5		2377	S31803	
	X 2 CrNiMoSi 19 5	1.4424	1.4417	X 2 CrNiMoSi 19 5	Z 2 CND 18.05.03				2376	S31500	
	X 2 NiCrMoCu 25 20 5	1.4539	1.4539	X 2 NiCrMoCu 25 20 5	Z 2 NCDU 25 20	904 S 13			2562	N08904	
	X 3 CrNiMo 27 5 2	1.4460	1.4460	X 4 CrNiMo 27 5 2	Z 3 CND 25.7 Az		X 3 CrNiMo 27 5 2	SUS 329 J 1	2324	S32900	
	X 5 CrNiCuNb 16 4	1.4980	1.4943	X 4 NiCrTi 25 15	Z 6 NCTDV 25.15	HR 51		SUH 660	2570	S66286	
M5	X 1 CrNiMoN 20 18 7	1.4547	1.4529	X 1 CrNiMoN 20 18 7	Z 1 CNDU 20.18.05 Az		X 1 CrNiMoN 20 18 7		2778	S31254	
	X 1 CrNiMoN 25 22 8	1.4652	1.4652	X 2 CrNiMoN 25 22 7						S32654	
	X 10 NiCrAlTi 32 20	1.4876	1.4876	X 10 NiCrAlTi 32 20	Z 10 NC 32.21			NCF 800		N08800	
	X 2 CrNiMoN 25 7 4	1.4410	1.4410	X 2 CrNiMoN 25 7 4	Z 3 CND 25.07 Az		X 2 CrNiMoN 25 7 4		2328	S32750	

Wstęp

Wiercenie

Rozwiercanie

Wytaczanie

Załącznik

SMG

U.N.E./I.H.A.	AISI / ASTM	GOST	ČSN	Inne marki	Warunki	Struktura
F.520L	L2	11KHF			Wyżarzone	
F.5220	O1	9KHVG			Wyżarzone	
	O2	9G2F			Wyżarzone	
F.5230	52100	SHKH15	14 109		Wyżarzone	
F.5212	D3	KH12			Wyżarzone	
	H11	4KH5MFS			Wyżarzone	
F.5318	H13	4KH5MF1S			Wyżarzone	
F.5227	A2	9KH5VF			Wyżarzone	
	H10	3KH3M3F			Wyżarzone	
F.5213		KH12			Wyżarzone	
		KH12MF			Wyżarzone	
F.520.S	L6	5KHNM			Wyżarzone	
F.5613	M35	R6M5K5			Wyżarzone	
	M42	R2AM9K5			Wyżarzone	
	T4	R18K5F2			Wyżarzone	
F.5603	M2	R6M5			Wyżarzone	
	M7				Wyżarzone	
	T1	R18			Wyżarzone	
	403	08KH13			Wyżarzone	Ferytyczne
F.3401	410, CA-15	12KH13, 08KH13			Wyżarzone	Martenzytyczne
F.3113	430	12KH17			Wyżarzone	Ferytyczne
F.5261	420	20KH13	17 022		Wyżarzone	Martenzytyczne
F.3404	420	40KH13			Wyżarzone	Martenzytyczne
	440 A				Wyżarzone	Martenzytyczne
	440 B	95KH18			Wyżarzone	Martenzytyczne
	440 C	95KH18			Wyżarzone	Martenzytyczne
	A182 F6NM			F6NM	Wyżarzone	Martenzytyczne
	446	15KH28			Wyżarzone	Ferytyczne
	XM-13			PH 13-8 Mo	Przesycane	Austenityczne
	XM-12			15-5 PH	H1150	Martenzytyczne
	XM-12			15-5 PH	Przesycane	Martenzytyczne
	XM-12			15-5 PH	H1025	Martenzytyczne
	SAE 630			17-4 PH	H1150	Martenzytyczne
	630			17-4 PH	Przesycane	Martenzytyczne
	631	09KH17N7YU1		17-7 PH	Przesycane	Austenityczne/ferytyczne
	AMS 6515			Marage 350	Przesycane	Martenzytyczne
	AMS 6521			Marage 300	Przesycane	Martenzytyczne
	AMS 6514			Marage 300, Vascomax C300	Przesycane	Martenzytyczne
	AMS 6512			Marage 250	Przesycane	Martenzytyczne
	AMS 6512			Marage 250, Vascomax C250	Przesycane	Martenzytyczne
F.3508	303	12KH19N9			Wyżarzone	Austenityczne
F.3504	304 L	03KH18N11			Wyżarzone	Austenityczne
F.3504	304	08KH18N10	17 240		Wyżarzone	Austenityczne
F.3534	316	08KH17H13M2T	17 346		Wyżarzone	Austenityczne
F.3524	347	08KH18N12B			Wyżarzone	Austenityczne
F.3517	301	07KH16N6			Wyżarzone	Austenityczne
	302	12KH18N9			Wyżarzone	Austenityczne
F.3533	(316 L)	03KH17N14M3	17 349		Wyżarzone	Austenityczne
	316 LN	03KH16N15M3			Wyżarzone	Austenityczne
F.3541	304 LN	03KH18N11			Wyżarzone	Austenityczne
	317	08KH17H15M3T			Wyżarzone	Austenityczne
				253 MA	Wyżarzone	Austenityczne
	310 S	12KH25N20			Wyżarzone	Austenityczne
	329 LN			SAF 2205	Wyżarzone	Duplex
				3RE60	Wyżarzone	Duplex
	904L				Wyżarzone	Super austenityczne
	329				Wyżarzone	Duplex
	660			A286	Przesycane	Austenityczne
				254 SMO	Wyżarzone	Super austenityczne
				654 SMO	Wyżarzone	Super austenityczne
				Alloy 800	Wyżarzone	Austenityczne
	F 53			SAF 2507	Wyżarzone	Super duplex

SMG

SMG	EN	EN-Nr	W.-Nr	DIN	AFNOR	BS	UNI	JIS	SS	UNS	
K1	EN-GJL-150	0.6150	0.6150	GG-15	Fl 15 D	Grade 150	G15	FC 150	01 15-00	F11601	
	EN-GJL-200	0.6200	0.6200	GG-20	Fl 20 D	Grade 220	G20	FC 200	01 20-00	F12101	
	EN-GJL-250	0.6250	0.6250	GG-25	Fl 25 D	Grade 260	G25	FC 250	01 25-00	F12401	
	EN-GJL-350	0.6350	0.6350	GG-35	Fl 35 D	Grade 350	G35	FC 350	01 35-00	F13502	
	EN-GJL-215			GG-220 HB					02 19		
K2	EN-GJV-300			GJV-300							
	EN-GJV-350			GJV-350							
	EN-GJV-400			GJV-400							
	EN-GJV-450			GJV-450							
	EN-GJV-500			GJV-500							
K3	EN-GJMB-550-4	0.8155		GTS-55-04	P 540/5	P 540/5	P 55-04	PCMP55-04	08 54-00	F24130	
K4	EN-GJS-350-22	0.7033	0.7033	GGG-35.3	FGS 370-17	Grade 350/22		FCD 350-22L	07 17-15		
	EN-GJS-400-15	0.7040	0.7040	GGG-40	FGS 400-12	Grade 420/12	GS 400-12	FCD 400-18L	07 17-02	F32800	
	EN-GJS-400-18	0.7043	0.7043	GGG-40.3	FGS 370-17	Grade 370/17	GSO 42/17		07 17-12	F32800	
	EN-GJS-500-7	0.7050	0.7050	GGG-50	FGS 500-7	Grade 500/7	GS 500-7	FCD 500-7	07 27-02	F33800	
	EN-GJS-600-3	0.7060	0.7060	GGG-60	FGS 600-3	Grade 600/3	GS 600-3	FCD 600-3	07 32-03	F34100	
	EN-GJS-700-2	0.7070	0.7070	GGG-70	FGS 700-2	Grade 700/2	GS 700-2	FCD 700-2	07 37-01	F34800	
K5	EN-GJS-1000-5			GJS-1000-5						ADI grade 5	
	EN-GJS-1200-2			GJS-1200-2						ADI grade 2	
	EN-GJS-1400-1			GJS-1400-1						ADI grade 3	
	EN-GJS-800-8			GJS-800-8						ADI grade 4	
K6	EN-GJLA-XNiCr 20-2	0.6660	0.6660	GGL-NiCr 20 2	FGL Ni20 Cr2	Grade F2			05 23-00	F41002	
	EN-GJLA-XNiCr 30-3	0.6676	0.6676	GGL-NiCr 30 3	FGL Ni30 Cr3	Grade F3				F41004	
	EN-GJLA-XNiCuCr 15-6-2	0.6655	0.6655	GGL-NiCuCr 15 6 2	FGL Ni15 Cu6 Cr2	Grade F1				F41000	
K7	EN-GJSA-XNiMn 13-7	0.7652	0.7652	GGG-NiMn 13 7	FGS Ni13 Mn7	Grade S6			07 72-00		
	EN-GJSA-XNiCr 20-2	0.7660	0.7660	GGG-NiCr 20 2	FGS Ni20 Cr2	Grade S2				F43000	
	EN-GJSA-XNiMn 23-4	0.7673	0.7673	GGG-NiMn 23 4	FGS Ni23 Mn4	Grade S2M				F43010	
	EN-GJSA-XNiCr 30-3	0.7676	0.7676	GGG-NiCr 30 3	FGS Ni30 Cr3	Grade S3				F43003	
	EN-GJSA-XNi 35	0.7683	0.7683	GGG-Ni 35	FGS Ni35					F43006	
N1	AW-1050A	Al99.5	3.0255	Al99.5	A-5/1050A	1B		(A1050)	4007	AA1050A	
	AW-2011	AlCuBiPb	3.1655	AlCuBiPb	A-U5PbBi/2011	FC1		A2011	4355	AA2011	
	AW-2014	AlCuSiMn	3.1255	AlCuSiMn	A-U4SG/2014	H15			4338	AA2014	
	AW-5005	AlMg1	3.3315	AlMg1	A-G0.6	N41			4106	AA5005	
	AW-6060	AlMgSi0.5	3.3206	AlMgSi0.5	A-GS/6060	(H9)			4103	AA6060	
	AW-6063	AlMgSi0.7	3.3210	AlMgSi0.7	A-GSUC/6061	(H10)		(A6063)	4104, 4107	AA6005	
	AW-3103	AlMn1	3.0515	AlMn1		N3			4054	AA3103	
	AW-3003	AlMn1Cu	3.0517	AlMn1Cu	A-M1/3003			A3003		AA3003	
	AW-7020	AlZn4.5Mg1	3.4335	AlZn4.5Mg1	A-Z5G/7020	H17			4425	AA7020	
	AW-7075		3.4365	AlZnMgCu1.5	A-Z5GU/7075	2L95/2L96			A7075	AA7075	
	AC-42000		3.2341	G-AlSi5Mg	A-S7G	LM25	3599		AC 4C	4244	
	AC-46200	AlSi8Cu3(Si)	3.2161	G-AlSi8Cu3						4251	A13800
	MG-P-63	MgAl6Zn	3.5612	G-MgAl6Zn	G-A6-Z1	MAG-E-121					M11600
	MG-P-61	MgAl8Zn	3.5812	G-MgAl8Zn	(G-A7-Z1)						
	MN65120	MgSe3Zn2Zr1	3.5103	G-MgSe3Zn2Zr1	ZRE1	MAG6-TE					M12330
	N2	AC-43400	AlSi10Mg(Fe)	3.2381	G-AlSi10Mg	A-S10G	LM9			4253	A13600
		AC-44200	AlSi12	3.2382	GD-AlSi12						
AW-6082		AlMgSi1	3.2315	AlMgSi1	A-SGM0.7/6082	H30			4212	AA6082	
N3				AlSi17Cu5				ADC14			
N11	CC331G		2.0940.01	CuAl10Fe	CuAl10Fe	AB1			5710	C95200	
	CC333G		2.0975.01	CuAl10Ni	CuAl10Ni5Fe5	AB2			5716	C95500	
				CuNi10Fe1Mn	CuNi10Fe1Mn	CN102			5667	C70600	
				CuNi10Zn45							
				CW408J	CuNi18Zn19Pb	CuNi18Zn19Pb1					C76300
	CW352H		2.1176	CuPb10Sn	CuSn10Pb10	LB2			5640	C93700	
	CC480K		2.1050.01	CuSn10	CuSn10	CT1			5443	C90700	
			2.1087	CuSn10Zn					5458	C90500	
	CW452K	CuSn6	2.1020	CuSn6	CuSn6	PB103		C5191	5428	C51900	
	CW502L	CuZn15	2.0240	CuZn15	CuZn15	CZ102		C2300	5112	C23000	
	CW706R	CuZn28Sn1	2.0470	CuZn28Sn1	CuZn29Sn1				5220	C44300	
	CW508L	CuZn37	2.0321	CuZn37	CuZn37	CZ108			5150	C27200	
	CW717R	CuZn38Sn1	2.0530	CuZn38Sn1						C46400	
	CW614N	CuZn39Pb3	2.0401	CuZn39Pb3	CuZn39Pb3	CZ121			5170	C38500	
	CW612N	CuZn40Pb2	2.0402	CuZn40Pb2	CuZn39Pb2	CZ120			5168	C37800	
	CW622N	CuZn44Pb2	2.0410	CuZn44Pb2		CZ104			5272	C68700	

Wstęp

Wferocenie

Rozwiercanie

Wytaczanie

Załącznik

SMG

SMG	EN	EN-Nr	W.-Nr	DIN	AFNOR	BS	UNI	JIS	SS	UNS
S1										
S2										
S3	NiMo30		2.4810							N10002
	NiMo16Cr15W		2.4819							N10276
	NiCr19Fe19Nb5Mo3		2.4668							N07718
			2.4669							N07750
	NiCr20TiAl		2.4631							N07080
	NiCr19Co18Mo4Ti3Al3									N07500
	NiCr20Co13Mo4Ti3Al		2.4654							N07001
S11			3.7024							R54620
S12										R56320
	TiAl6V4		3.7164							R56400
S13				TiV10Fe2Al3						
H3	16 MnCr 5	1.7131	1.7131	16 MnCr 5	16 MC 5	527 M 17	16 MnCr 5	SCR 415	2511	G51170
H5	C 67S	1.1231	1.1231	Ck 67	XC 68	060 A 67	C 70		1770	G10700
	C 75S	1.1248	1.1248	Ck 75	XC 75	060 A 78	C 75		1774, 1778	G10780
	C 100S	1.1274	1.1274	Ck 101		060 A 96		SUP 4	1870	G10950
	C 105U	1.1545	1.1545	C 105 W1	Y1 105		C 100 KU		1880	
			1.2550	60 WCrV 7	55 WC 20		55 WCrV 8 KU			
	55 Cr 3	1.7176	1.7176	55 Cr 3	55 C 3	527 A 60	55 Cr 3	SUP 9 (A)	2253	G51550
	42 CrMo 4	1.7225	1.7225	42 CrMo 4	42 CD 4	708 M 40	42 CrMo 4	SCM 440 (H)	2244	G41400
H7	107 CrV 3	1.2210	1.2210	115 CrV 3	100 C 3		107 CrV 3 KU			T61202
			1.2510	100 MnCrW 4	90 MWCV 5	BO 1	95 MnWCr 5 KU	SKS 3	2140	T31501
	90 MnCrV 8	1.2842	1.2842	90 MnCrV 8	90 MV 8	BO 2	90 MnVCr 8 KU			T31502
	100 Cr 6	1.3505	1.3505	100 Cr 6	100 C 6	534 A 99	100 Cr 6	SUJ 2	2258	G51986
H8	X 40 CrMoV 5 1	1.2344	1.2344	X 40 CrMoV 5 1	Z 40 CDV 5	BH 13	X 40 CrMo 5 1 1 KU	SKD 61	2242	T20813
	X 100 CrMoV 5	1.2363	1.2363	X 100 CrMoV 5 1	Z 100 CDV 5	BA 2	X 100 CrMoV 5 1 KU	SKD 12	2260	T30102
	X 155 CrVMo 12 1		1.2379	X 155 CrVMo 12 1	Z 160 CDV 12	BD 2	X 155 CrVMo 12 1 KU	SKD 11		T30402
			1.2436	X 210 CrW 12			X 215 CrW 12 1 KU	SKD 2	2312	
			1.2601	X 165 CrMoV 12			X 165 CrMoV 12 KU		2310	
			1.2713	55 NiCrMoV 6	55 NCDV 7			SKT 4		T61206
	HS 6-5-2-5	1.3243	1.3243	S 6-5-2-5	Z 85 WDKCV 06-05-05-04-02		HS 6-5-2-5	SKH 55	2723	
H11	HS 2-10-1-8	1.3247	1.3247	S 2-10-1-8	Z 110 DKCWV 09-08-	BM 42	HS 2-9-1-8	SKH 51		T11342
	HS 18-0-1	1.3355	1.3355	S 18-0-1	Z 80 WCV 18-04-01	BT 1	HS 18-0-1	SKH 2		T12001
	X 20 Cr 13	1.4021	1.4021	X 20 Cr 13	Z 20 C 13	420 S 37	X 20 Cr 13	SUS 420 J 1	2303	S42000
H12	X 70 CrMo 15	1.4109	1.4109	X 65 CrMo 14	Z 70 D 14			SUS 440 A		S44002
	X 90 CrMoV 18	1.4112	1.4112	X 90 CrMoV 18	Z 2 CND 18 05	409 S 19	X CrTi 12	SUS 440 B	2327	S44003
	X 105 CrMo 17	1.4125	1.4125	X 105 CrMo 17	Z 100 CD 17		X 105 CrMo 17	SUS 440 C		S44004
	X 4 CrNiCuNb 16 4	1.4540	1.4540	X 4 CrNiCuNb 16 4						S15500
	X 5 CrNiCuNb 16 4	1.4542	1.4542	X 5 CrNiCuNb 16 4				SUS 630		S17400
	X 5 CrNiCuNb 16 4	1.4542	1.4542	X 5 CrNiCuNb 16 4				SUS 630		S17400
	X 7 CrNiAl 17 7	1.4568	1.4568	X 7 CrNiAl 17 7	Z 9 CAN 17.7	301 S 81	X 7 CrNiAl 17 7	SUS 631	2388	S17700
	X 8 CrNiMoAl 15 7 5	1.4574	1.4574	X 8 CrNiMoAl 15 7 5						S15700
	X 6 NiCrTiMoV 25 15	1.4980	1.4943	X 4 NiCrTi 25 15	Z 6 NCTDV 25.15	HR 51		SUH 660	2570	S66286
	X 2 NiCoMo 18 8 5	1.6359	1.6359	X 2 NiCoMo 18 8 5		S 162				K92890
	X 2 NiCoMoTi 18 9 5	1.6358	1.6358	X 2 NiCoMoTi 18 9 5	Z 2 NKD 19-09					K93120
	X 2 NiCoMoTi 18 9 5	1.6358	1.6358	X 2 NiCoMoTi 18 9 5	Z 2 NKD 19-09					K93120
X 2 NiCoMoTi 18 12 4	1.6356	1.6356	X 2 NiCoMoTi 18 12 4						K93160	
H21	X 120 Mn 12	1.3401	1.3401	X 120 Mn 12	Z 120 M 12	BW 10		SC MnH 1	2183	
H31	EN-GJN-HV520	0.9620	0.9620	G-X330 NiCr 4 2	FB Ni4 Cr2 BC	Grade 2 A			05 12-00	F45001
	EN-GJN-HV550	0.9625	0.9625	G-X260 NiCr 4 2	FB Ni4 Cr2 HC	Grade 2 B			05 13-00	F45000
	EN-GJN-HV600(XCr11)	0.9630	0.9630	G-X300 CrNiSi 9 5 2	FB Cr9 Ni5	Grade 2 C, D, E			04 57-00	F45003

Wstęp

Wiercenie

Rozwiercanie

Wytaczanie

Załącznik

SMG

U.N.E./ I.H.A.	AISI / ASTM	GOST	ČSN	Inne marki	Warunki	Struktura
				Discalloy	Utwardzane wydzieleniowo	
				Haynes 25		
				Stellite 21		
				Hastelloy C		
		KHN65MV		Hastelloy C-276		
				IN 100		
				Inconel 718		
				Inconel X-750	Przesycane	
				Nimonic 80A		
				René 41		
				Udimet 500		
				Waspalloy		
				Ti	Czysty komercyjnie	Ti (α)
	AMS 4919			Ti 6-2-4-2	Wyżarzane	Ti (α)
	AMS 4943			Ti 3Al-2.5V (grd 9)	Wyżarzane	Ti (α + β)
	AMS 4920, Grade 5	VT6		Ti 6Al-4V	Wyżarzane	Ti (α + β)
	AMS 4986			Ti 10V-2Fe-3Al	Wyżarzane	Ti (β)
F.1516	5115	12KHN2	14 220		Hartowane powierzchniowo	
F.5103	1070	70			Hartowane & odpuszczane	
F.5107	1078, 1080	75			Hartowane & odpuszczane	
F.5117	1095				Hartowane & odpuszczane	
F.5118	W1	U10A			Hartowane & odpuszczane	
	S1	5KHV2SF			Hartowane & odpuszczane	
	5155				Hartowane & odpuszczane	
F.1252	4142, 4140	38HM	15 142		Hartowane & odpuszczane	
F.520L	L2	11KHF			Hartowane & odpuszczane	
F.5220	O1	9KHVG			Hartowane & odpuszczane	
	O2	9G2F			Hartowane & odpuszczane	
F.5230	52100	SHKH15	14 109		Hartowane & odpuszczane	
F.5318	H13	4KH5MF1S			Hartowane & odpuszczane	
F.5227	A2	9KH5VF			Hartowane & odpuszczane	
F.5211	D2	KH12MF			Hartowane & odpuszczane	
F.5213		KH12			Hartowane & odpuszczane	
		KH12MF			Hartowane & odpuszczane	
F.520.S	L6	5KHNM			Hartowane & odpuszczane	
F.5613	M35	R6M5K5			Hartowane & odpuszczane	
	M42	R2AM9K5			Hartowane & odpuszczane	
	T1	R18			Hartowane & odpuszczane	
F.5261	420	20KH13	17 022		Hartowane & odpuszczane	Martenzyczne
	440 A				Hartowane & odpuszczane	Martenzyczne
	440 B	95KH18			Hartowane & odpuszczane	Martenzyczne
	440 C	95KH18			Hartowane & odpuszczane	Martenzyczne
	XM-12			15-5 PH	H900	Martenzyczne
	SAE 630			17-4 PH	H1025	Martenzyczne
	SAE 630			17-4 PH	H900	Martenzyczne
	AMS 5528	09KH17N7YU1		17-7 PH	TH1050	Martenzyczne
	632			PH 15-7 Mo	TH1050	Martenzyczne
	660			A286	Utwardzane wydzieleniowo	Austenicyczne
	AMS 6512			Marage 250	Utwardzane wydzieleniowo	Martenzyczne
	AMS 6521			Marage 300	Utwardzane wydzieleniowo	Martenzyczne
	AMS 6521			Marage 300	Utwardzane wydzieleniowo	Martenzyczne
	AMS 6515			Marage 350	Utwardzane wydzieleniowo	Martenzyczne
	A128 Grade A			Hadfield		
	A532 IB (NiC-LC)			Ni-Hard 2		Żelwo białe
	A532 IA (NiC-HC)			Ni-Hard 1		Żelwo białe
	A532 ID (Ni-HiCr)			Ni-Hard 4		Żelwo białe

Płytki węglkowe oraz narzędzia

Płytki węglkowe oraz narzędzia Seco Tools nie są włączone w asortyment produktów mających podlegać poniższym wymaganiom. Jednakże Seco Tools deklaruje co następuje. Powyższe produkty spełniają wszystkie wymagania specyfikacji RoHS (Ograniczenia w stosowaniu niebezpiecznych substancji w urządzeniach elektrycznych i elektronicznych), WEEE (Złomowanie urządzeń elektrycznych i elektronicznych) oraz ELV (Pojazdy wycofane z eksploatacji). Produkty nie zawierają rtęci, ołowiu, sześciowartościowego chromu, kadmu, CFC, HCFC, środków zmniejszających palność lub rozpuszczalników o stężeniu przekraczającym dopuszczalne normy.

Ostrzeżenie:

Ostrzeżenie na sucho lub z chłodziwem może powodować potencjalne ryzyko powstania pyłów lub oparów powodujących podrażnienia skóry, oczu lub dróg oddechowych. Aby tego uniknąć należy stosować odpowiednie środki zabezpieczające.

Odsprzedaż:

Seco Tools może odkupić zużyte płytki i narzędzia węglkowe do celów recyklingu. Płytki i narzędzia węglkowe powinny być oddzielone od innych odpadów (stalowych, aluminiowych, miedzianych itp.). Wszystkie opakowania podlegają recyklingowi.

Płytki CBN i PCD

Płytki Seco Tools nie są włączone w asortyment produktów mających podlegać poniższym wymaganiom. Jednakże Seco Tools deklaruje co następuje. Powyższe produkty spełniają wszystkie wymagania specyfikacji RoHS (Ograniczenia w stosowaniu niebezpiecznych substancji w urządzeniach elektrycznych i elektronicznych), WEEE (Złomowanie urządzeń elektrycznych i elektronicznych) oraz ELV (Pojazdy wycofane z eksploatacji). Produkty nie zawierają rtęci, ołowiu, sześciowartościowego chromu, kadmu, CFC, HCFC, środków zmniejszających palność lub rozpuszczalników o stężeniu przekraczającym dopuszczalne normy.

Ostrzeżenie:

Ostrzeżenie na sucho lub z chłodziwem może powodować potencjalne ryzyko powstania pyłów lub oparów powodujących podrażnienia skóry, oczu lub dróg oddechowych. Aby tego uniknąć należy stosować odpowiednie środki zabezpieczające.

Odsprzedaż:

Seco Tools może odkupić zużyte płytki CBN lub PCD do celów recyklingu. Płytki powinny być oddzielone od innych odpadów (stalowych, aluminiowych, miedzianych itp.). Monolityczne płytki CBN mogą trafić na wysypisko śmieci. Wszystkie opakowania podlegają recyklingowi.

Narzędzia oksydowane

Narzędzia Seco Tools nie są włączone w asortyment produktów mających podlegać poniższym wymaganiom. Jednakże Seco Tools deklaruje co następuje. Powyższe produkty spełniają wszystkie wymagania specyfikacji RoHS (Ograniczenia w stosowaniu niebezpiecznych substancji w urządzeniach elektrycznych i elektronicznych), WEEE (Złomowanie urządzeń elektrycznych i elektronicznych) oraz ELV (Pojazdy wycofane z eksploatacji). Produkty nie zawierają rtęci, ołowiu, sześciowartościowego chromu, kadmu, CFC, HCFC, środków zmniejszających palność lub rozpuszczalników o stężeniu przekraczającym dopuszczalne normy.

Odsprzedaż:

Zużyte narzędzia mogą być oddane do recyklingu razem ze zwykłymi odpadami stalowymi (wióry oraz zbrakowane detale). Wszystkie opakowania podlegają recyklingowi.

Płytki Cermetalowe

Płytki Seco Tools nie są włączone w asortyment produktów mających podlegać poniższym wymaganiom. Jednakże Seco Tools deklaruje co następuje. Powyższe produkty spełniają wszystkie wymagania specyfikacji RoHS (Ograniczenia w stosowaniu niebezpiecznych substancji w urządzeniach elektrycznych i elektronicznych), WEEE (Złomowanie urządzeń elektrycznych i elektronicznych) oraz ELV (Pojazdy wycofane z eksploatacji). Płytki cermetalowe w gatunku C15M zawierają nikiel i w kontakcie ze skórą może nastąpić zatrucie nikiem. Wielkość przenikania jest większa niż w normie SS-EN 1811 metoda prowadzenia testu uwalniania niklu z materiału przy przenikaniu bezpośrednim i przy przedłużonym kontakcie ze skórą. Metoda ta jest przeznaczona do produktów będących w bezpośrednim lub przedłużonym kontakcie ze skórą, dlatego nie ma bezpośredniego zastosowania do płytek cermetalowych. Osoby posiadające alergię na nikiel powinny stosować rękawice ochronne przy kontakcie z płytkami cermetalowymi.

Ostrzeżenie:

Ostrzeżenie na sucho lub z chłodziwem może powodować potencjalne ryzyko powstania pyłów lub oparów powodujących podrażnienia skóry, oczu lub dróg oddechowych. Aby tego uniknąć należy stosować odpowiednie środki zabezpieczające.

Odsprzedaż:

Zużyte płytki mogą być poddane recyklingowi. Płytki powinny być oddzielone od innych odpadów (stalowych, aluminiowych, miedzianych itp.) włącznie z płytkami węglkowym. Wszystkie opakowania podlegają recyklingowi.

Narzędzia pokryte nikiem

Narzędzia Seco Tools nie są włączone w asortyment produktów mających podlegać poniższym wymaganiom. Jednakże Seco Tools deklaruje co następuje. Powyższe produkty spełniają wszystkie wymagania specyfikacji RoHS (Ograniczenia w stosowaniu niebezpiecznych substancji w urządzeniach elektrycznych i elektronicznych), WEEE (Złomowanie urządzeń elektrycznych i elektronicznych) oraz ELV (Pojazdy wycofane z eksploatacji). Produkty nie zawierają rtęci, ołowiu, sześciowartościowego chromu, kadmu, CFC, HCFC, środków zmniejszających palność lub rozpuszczalników o stężeniu przekraczającym dopuszczalne normy.

Narzędzia zawierają nikiel i w kontakcie ze skórą może nastąpić zatrucie nikiem. Wielkość przenikania jest nie większa niż w normie SS-EN 1811 metoda prowadzenia testu uwalniania niklu z materiału przy przenikaniu bezpośrednim i przy przedłużonym kontakcie ze skórą. Metoda ta jest przeznaczona do produktów będących w bezpośrednim lub przedłużonym kontakcie ze skórą, dlatego nie ma bezpośredniego zastosowania do narzędzi. Osoby posiadające alergię na nikiel powinny stosować rękawice ochronne przy kontakcie z narzędziami.

Odsprzedaż:

Zużyte narzędzia mogą być oddane do recyklingu razem ze zwykłymi odpadami stalowymi (wióry oraz zbrakowane detale). Wszystkie opakowania podlegają recyklingowi.

Dodatki stopowe

Gatunek	Węglik spiekany											Pokrycie						
	W	Ti	Ta	Nb	Co	Cr	Ni	Mo	C	N	Ru	Ti	Al	C	N	O	Si	Nb
CP20	■				■				■			■			■			
CP200	■				■	■			■			■	■		■			
CP300	■	■	■	■	■				■			■	■		■			
CP500	■				■	■			■			■	■		■			
CP600	■				■	■			■			■	■		■			
C15M	■	■	■	■	■		■	■	■		■				■			
CF	■				■		■	■	■									
CM	■				■		■	■	■									
DP2000	■				■				■			■	■	■	■	■		
DP3000	■	■	■	■	■				■			■	■	■	■	■		
DS2050	■				■	■			■			■	■		■			■
DS4050	■				■	■			■			■	■		■			■
F15M	■				■	■			■			■	■		■			
F25M	■	■	■	■	■				■			■	■		■			
F30M	■				■	■			■			■	■		■			
F40M	■				■	■			■			■	■		■			
HX	■		■		■				■			■			■			
H02	■		■		■				■			■			■			
H15	■				■				■			■			■			
H25	■				■				■			■			■			
KX	■				■				■			■			■			
MH1000	■				■				■			■	■		■			
MK1500	■		■		■				■			■	■	■	■	■		
MK2050	■		■		■				■			■	■	■	■		■	
MM4500	■				■	■			■			■	■	■	■	■		
MP1501	■		■	■	■				■			■	■	■	■	■		
MP2050	■				■				■		■	■	■	■	■	■		
MP2501	■		■	■	■				■			■	■	■	■	■		
MP3000	■				■	■			■			■	■	■	■	■		
MS2500	■		■	■	■				■			■	■	■	■	■		
MS2050	■				■	■			■			■	■	■	■	■		
RX1500	■		■		■		■	■	■			■	■	■	■			■
RX2000	■		■		■				■			■	■	■	■			
RM2020	■				■				■			■	■	■	■			
RM2090	■				■				■			■	■	■	■			
RN2010	■				■				■			■	■	■	■		■	
RS2090	■				■				■			■	■	■	■		■	
T350M	■		■	■	■				■			■	■	■	■	■		
T25M	■		■	■	■				■			■	■	■	■	■		
TGH1050	■				■	■			■			■	■	■	■	■		
TGK1500	■				■				■			■	■	■	■	■		
TGP25	■	■	■	■	■				■			■	■	■	■	■		
TGP35	■		■	■	■				■			■	■	■	■	■		
TGP45	■		■	■	■				■			■	■	■	■	■		
TGS2050	■				■	■			■			■	■	■	■	■		
TH1000	■				■				■			■	■	■	■	■		
TH1500	■				■				■			■	■	■	■	■		
TK0501	■				■				■			■	■	■	■	■		
TK1501	■				■				■			■	■	■	■	■		
TM1501	■	■	■	■	■				■			■	■	■	■	■		
TM2000	■	■	■	■	■				■			■	■	■	■	■		
TM2501	■	■	■	■	■				■			■	■	■	■	■		
TM3501	■				■				■			■	■	■	■	■		
TM4000	■	■	■	■	■				■			■	■	■	■	■		
TP0501	■	■	■	■	■				■			■	■	■	■	■		
TP1020	■	■	■	■	■				■			■	■	■	■	■		
TP1030	■	■	■	■	■				■			■	■	■	■	■		
TP1501	■	■	■	■	■				■			■	■	■	■	■		
TP25	■	■	■	■	■				■			■	■	■	■	■		
TP200	■	■	■	■	■				■			■	■	■	■	■		
TP2501	■	■	■	■	■				■			■	■	■	■	■		
TP3501	■	■	■	■	■				■			■	■	■	■	■		
TP40	■				■				■			■	■	■	■	■		
TS2000	■				■	■			■			■	■	■	■	■		
TS2050	■				■	■			■			■	■	■	■	■		
TS2500	■		■		■				■			■	■	■	■	■		■
TTP2050	■				■	■			■			■	■	■	■	■		■
T250D	■				■				■			■	■	■	■	■		
T400D	■				■				■			■	■	■	■	■		
T100R	■				■				■			■	■	■	■	■		
T60M	■	■	■	■	■				■			■	■	■	■	■		
883	■		■		■				■			■	■	■	■	■		
890	■				■	■			■			■	■	■	■	■		

Wstęp

Wfoczenie

Rozwiercanie

Wytaczanie

Załącznik

Niniejszy katalog został wydany przez Seco Tools z intencją zaprezentowania ogólnej informacji oraz kierunków w branży obróbki skrawaniem. W przypadku potrzeby profesjonalnego wsparcia dla konkretnego przypadku, potrzebna będzie pomoc specjalisty.

Informacje są dostarczane w stanie “faktycznym”;

Seco Tools zrzeka się wszelkich zobowiązań i gwarancji, wyrażonych lub dorozumianych, dowolnego rodzaju, w tym, bez ograniczeń, wszelkich gwarancji handlowych, przydatności do konkretnego celu lub nienaruszalności.

Informacje przedstawione tu są tylko dla celów porównawczych. Aktualne ceny, specyfikacje i opisy produktów powinny być określone w momencie sprzedaży i mogą się różnić zależnie do lokalizacji. Zawarte tu informacje mogą podlegać zmianie bez wcześniejszego powiadomienia.

WWW.SECOTOOLS.COM

70024895, ST20236776 PL,
© SECO TOOLS AB, 2023.
Wszystkie prawa zastrzeżone.
Informacje techniczne mogą ulec
zmianie bez powiadamiania.